

LITTLE AND FALACE'S

DENTAL MANAGEMENT

of the Medically
Compromised Patient

Ninth Edition

James W. Little
Craig S. Miller
Nelson L. Rhodus

ELSEVIER



EVOLVE STUDY RESOURCES
FREE WITH TEXTBOOK PURCHASE
EVOLVE.ELSEVIER.COM

TABLE OF CONTENTS

Dental Management: A Summary, xiii

PART I Patient Evaluation and Risk Assessment, 1

- 1 Patient Evaluation and Risk Assessment, 2

PART II Cardiovascular Disease, 18

- 2 Infective Endocarditis, 19
- 3 Hypertension, 38
- 4 Ischemic Heart Disease, 53
- 5 Cardiac Arrhythmias, 70
- 6 Heart Failure (or Congestive Heart Failure), 86

PART III Pulmonary Disease, 100

- 7 Pulmonary Disease, 101
- 8 Smoking and Tobacco Use Cessation, 128
- 9 Sleep-Related Breathing Disorders, 138

PART IV Gastrointestinal Disease, 150

- 10 Liver Disease, 151
- 11 Gastrointestinal Disease, 176

PART V Genitourinary Disease, 192

- 12 Chronic Kidney Disease and Dialysis, 193
- 13 Sexually Transmitted Diseases, 210

PART VI Endocrine and Metabolic Disease, 229

- 14 Diabetes Mellitus, 230
- 15 Adrenal Insufficiency, 255
- 16 Thyroid Diseases, 268
- 17 Women's Health Issues, 288

PART VII Immunologic Disease, 308

- 18 AIDS, HIV Infection, and Related Conditions, 309

- 19 Allergy, 330

- 20 Rheumatologic Disorders, 345

- 21 Organ Transplantation, 370

PART VIII Hematologic and Oncologic Disease, 389

- 22 Disorders of Red Blood Cells, 390

- 23 Disorders of White Blood Cells, 402

- 24 Acquired Bleeding and Hypercoagulable Disorders, 428

- 25 Congenital Bleeding and Hypercoagulable Disorders, 457

- 26 Cancer and Oral Care of Patients With Cancer, 480

PART IX Neurologic, Behavioral, and Psychiatric Disorders, 515

- 27 Neurologic Disorders, 516

- 28 Anxiety and Eating Disorders, 544

- 29 Psychiatric Disorders, 561

- 30 Drug and Alcohol Abuse, 581

Appendices, 596

- A Guide to Management of Common Medical Emergencies in the Dental Office, 597

- B Guidelines for Infection Control in Dental Health Care Settings, 606

- C Therapeutic Management of Common Oral Lesions, 623

- D Drug Interactions of Significance in Dentistry, 639

- E Drugs Used in Complementary and Alternative Medicine of Potential Importance in Dentistry, 645

Index, 655

LITTLE AND FALACE'S

**DENTAL
MANAGEMENT**
of the Medically
Compromised Patient

evolve

ELSEVIER

YOU'VE JUST PURCHASED MORE THAN A TEXTBOOK!

Evolve Student Resources for *Little and Falace's: Dental Management of the Medically Compromised Patient*, 9th Edition, include the following:

STUDENT RESOURCES:

- Animations
 - Three-dimensional animations demonstrate topics such as irregular heartbeats, coronary artery disease, dialysis, diabetes, fetal development, arthritis, chemotherapy, and radiation therapy.
- Mind Maps
 - Mind Maps for each chapter give visual breakdown of the key information in the chapter, great for quick review or taking notes.
- Printable version of the Dental Management Summary Table
 - A quick and easy reference table that presents the most important factors to be considered in the management of the medically compromised patient.
- Weblinks
 - A variety of weblinks for further study and research.



INSTRUCTOR RESOURCES:

- 367-question Test Bank
- PowerPoint Lecture Slides
- Image Collection
- Syllabus Conversion Guide

Activate the complete learning experience that comes with each textbook purchase by registering at

<http://evolve.elsevier.com/Little/compromised/>

REGISTER TODAY!

You can now purchase Elsevier products on Evolve!
Go to evolve.elsevier.com/html/shop-promo.html to search and browse for products.

LITTLE AND FALACE'S

DENTAL MANAGEMENT *of the* Medically Compromised Patient

Ninth Edition

James W. Little, DMD, MS

Professor Emeritus
University of Minnesota
School of Dentistry
Minneapolis, Minnesota; Naples, Florida

Craig S. Miller, DMD, MS

Professor of Oral Diagnosis and Oral Medicine
Provost Distinguished Service Professor
Department of Oral Health Practice
Department of Microbiology, Immunology and Genetics
The University of Kentucky College of Dentistry and College of Medicine
Lexington, Kentucky

Nelson L. Rhodus, DMD, MPH

Morse Distinguished Professor and Director
Division of Oral Medicine, Oral Diagnosis and Oral Radiology
University of Minnesota
School of Dentistry and College of Medicine
Minneapolis, Minnesota

ELSEVIER

ELSEVIER

3251 Riverport Lane
St. Louis, Missouri 63043

LITTLE AND FALACE'S DENTAL MANAGEMENT OF
THE MEDICALLY COMPROMISED PATIENT, NINTH EDITION

ISBN: 9780323443555

Copyright © 2018 by Elsevier, Inc. All rights reserved.

Previous editions copyrighted 2013, 2008, 2002, 1997, 1993, 1988, 1984, and 1980.

No part of this publication may be reproduced or transmitted in any form or by any means, electronic or mechanical, including photocopying, recording, or any information storage and retrieval system, without permission in writing from the publisher. Details on how to seek permission, further information about the Publisher's permissions policies and our arrangements with organizations such as the Copyright Clearance Center and the Copyright Licensing Agency, can be found at our website: www.elsevier.com/permissions.

This book and the individual contributions contained in it are protected under copyright by the Publisher (other than as may be noted herein).

Notices

Knowledge and best practice in this field are constantly changing. As new research and experience broaden our understanding, changes in research methods, professional practices, or medical treatment may become necessary.

Practitioners and researchers must always rely on their own experience and knowledge in evaluating and using any information, methods, compounds, or experiments described herein. In using such information or methods they should be mindful of their own safety and the safety of others, including parties for whom they have a professional responsibility.

With respect to any drug or pharmaceutical products identified, readers are advised to check the most current information provided (i) on procedures featured or (ii) by the manufacturer of each product to be administered, to verify the recommended dose or formula, the method and duration of administration, and contraindications. It is the responsibility of practitioners, relying on their own experience and knowledge of their patients, to make diagnoses, to determine dosages and the best treatment for each individual patient, and to take all appropriate safety precautions.

To the fullest extent of the law, neither the Publisher nor the authors, contributors, or editors, assume any liability for any injury and/or damage to persons or property as a matter of products liability, negligence or otherwise, or from any use or operation of any methods, products, instructions, or ideas contained in the material herein.

Library of Congress Cataloging-in-Publication Data

Names: Little, James W., 1934- author. | Miller, Craig S., author. | Rhodus, Nelson L., author.

Title: Little and Falace's dental management of the medically compromised patient / James W. Little, Craig S. Miller, Nelson L. Rhodus.

Description: Ninth edition. | St. Louis, Missouri : Elsevier, Inc., [2018] |

Preceded by Little and Falace's dental management of the medically compromised patient / James W. Little ... [et al.]. 8th ed., c2013. | Includes bibliographical references.

Identifiers: LCCN 2017025872 (print) | LCCN 2017027016 (ebook) | ISBN 9780323443951 (Ebook) | ISBN 9780323443555 (pbk. : alk. paper)

Subjects: | MESH: Dental Care | Dental Care for Chronically Ill | Oral Manifestations

Classification: LCC RK55.S53 (ebook) | LCC RK55.S53 (print) | NLM WU 29 | DDC 617.6-dc23

LC record available at <https://lcn.loc.gov/2017025872>

Senior Content Strategist: Jennifer Flynn-Briggs

Senior Content Development Specialist: Diane Chatman

Publishing Services Manager: Deepthi Unni

Project Manager: Manchu Mohan

Designer: Renee Duenow

Printed in China

Last digit is the print number: 9 8 7 6 5 4 3 2 1



Working together
to grow libraries in
developing countries

www.elsevier.com • www.bookaid.org

We dedicate this ninth edition to our role model and close friend:

Dr. Selverio “Sol”/“Bud” Silverman, Jr., MA, DDS



In 2014, we lost our dearest colleague:
Each of us in dentistry has been truly blessed by Dr. Silverman:

As a professor of oral medicine at University of California, San Francisco (UCSF) School of Dentistry, for many years, Silverman headed one of UCSF’s oral medicine clinics and was an advocate for prevention and early detection of oral cancer as well as AIDS. Silverman was a diplomat of the American Board of Oral Medicine, past president of the Board, and past President of the American Academy of Oral Medicine (AAOM). Dr. Silverman was a consultant to the American Dental Association Council on Scientific Affairs and a national spokesperson for the Association. He published more than 300 scientific articles, chapters in textbooks, and monographs. He received the prestigious Margaret Hay Edwards medal from the American Association for Cancer Education for outstanding contributions.

UCSF Enumeration on October 16, 2006, yet practiced until his death.

Deceased August 14, 2014, at 88 years of age.

Dr. Selverio Silverman, Jr., gave back so much to oral medicine profession worldwide and encouraged others around the world and as well as his fellow oral medicine colleges and students at UCSF’s oral medicine clinics yearly, stressing each to become an active member in AAOM. Filled with pride and love, Bud exchanged his family stories over the years with each of us. “Bud” was a very well-rounded doctor and family man who was filled with pride and love of both his family and his profession.

Oral medicine educators, doctors, students, and AAOM members should never tire of challenging each other academically because change makes for evolving changes, and teaming up with each other professionally makes for the very best for oral medicine worldwide. Giving is better than receiving always.

Thanks, “Bud,” for giving each of us your very best.

Dear friend, you shall always be missed.

Dr. “Bud” Silverman, Jr., has written the Foreword for this textbook for the prior last five editions. This book serves as a textbook as well as a must-have reference book for every dental office in the United States as well as throughout the world.

Dr. Sol Silverman, Jr., and Dr. James W. Little were best friends for the past 45+ years. Their world was carved with the same great values, yet they practiced and taught oral medicine more than 3250 miles apart. Jim and Bud were tethered via phone as they dedicated their lives to oral medicine through their teachings, research, and their own publications and textbooks. Each authored oral medicine textbooks as well as massive publications. Each had the total support and love of each of their own families, their own university workplace, and fellow members of the AAOM. Bud and Jim shared their love of sports by playing tennis, golf, and pick-up basketball into their 80s. They kept young by enjoying their daily playtime with their college kids and all their AAOM friends. “Bud” Silverman is missed daily by each of us involved with oral medicine.

Dr. James W. Little

This page intentionally left blank

It has been said that dental offices of the past were often located upstairs, on second floors, to screen out those who were too infirm to undergo dental treatment. Patients able to climb the flight of stairs to the office were considered fit enough to treat.

Largely because of modern medical care, people today are living and working with medical conditions that in the past might have been disabling or even unsurvivable. Statistics from 2012 show that roughly half of noninstitutionalized U.S. adults had one or more of 10 chronic medical conditions (hypertension, coronary heart disease, stroke, diabetes, cancer, arthritis, hepatitis, weak or failing kidneys, current asthma, or chronic obstructive pulmonary disease). Almost a quarter (24.3%) had one of these conditions, 13.87% had two, and 11.7% had three or more. Approximately one fourth of U.S. adults have more than one chronic illness.¹

As one might expect, the incidence of chronic illness increases with age. A total of 69.5% of U.S. adults age 55 to 64 years had one or more of six chronic conditions (arthritis, current asthma, cancer, cardiovascular disease, chronic obstructive pulmonary disease, and diabetes), 37.1% had two or more, and 14.4% had three or more. For ages 65 years and older, the percentages increase to 85.6%, 56.0%, and 23.1%, respectively. Women were more affected than men in all age groups (2008 data).²

Prescription medication is a mainstay of modern health care, and all age groups use them. A total of 14.1% of children younger than age 12 years, 17.3% age 12 to 29 years, and almost 20% of adults age 20 to 59 years use a prescription medication. Of adults age 60 years and older, roughly a quarter take one or two prescription medications, and almost four of 10 people (36.7%) take five or more prescription medications.³ Almost one quarter of U.S. adults older than 65 years have three or more chronic illnesses, and more than one third take five or more medications.

Nowadays, many patients no longer have “a doctor.” Instead, a patient may see multiple doctors for his or her various conditions, such as a cardiologist for coronary artery disease, an endocrinologist for diabetes, a rheumatologist for arthritis, an oncologist for cancer, a psychiatrist for depression—the list can go on and on. This can make medical consultation challenging for the dentist because each specialist focuses on his or her own area and cannot be expected to be knowledgeable about the details of dental diseases and treatments. The dentist cannot expect simply to request a “clearance”

from one of the patient’s physicians, who may not have a thorough understanding of what the proposed treatment entails.

It is therefore essential that the dentist understand how patients’ dental diagnoses and planned treatment relate to their medical diagnoses and treatment. For example, some patients may take anticoagulants or have bleeding disorders that affect dental surgical options and require special considerations in treatment planning. Medical treatments such as head and neck radiation therapy or antiosteoclast medications may impair healing after dental infections or dental surgical procedures, and failure to appreciate and take into account such relationships may put patients at risk for serious complications. Some medical conditions, if unstable, may pose a risk of intraoperative medical emergency during dental treatment and may require modification of treatment planning and delivery. Organ and hematopoietic transplant recipients are an increasingly large group of patients, and among their considerations is the potential for opportunistic infections and malignancies, which can occur in the oral cavity as well as elsewhere. Certain medical problems may themselves adversely affect dental health, such as a patient with physical or cognitive impairment that precludes effective dental hygiene or a patient whose illness or medication produces such profound xerostomia that caries cannot be controlled.

Medications that a patient is taking may create the potential for interactions that must be considered when the dentist wishes to prescribe or administer a drug. In addition, therapeutic effects of medications, such as anticoagulation, or adverse effects, such as xerostomia or mucosal reactions, may bear on dental management. Advanced age, or renal, hepatic, or other diseases that alter drug uptake, metabolism, clearance, or response may require dosage adjustments. Furthermore, each new drug creates the potential for known or as yet unknown drug interactions and side effects, and adverse effects of older medications continue to be discovered with ongoing use.

These are just a few examples of common conditions that can impact dental management. Although the most complex and seriously ill patients may require specialists to provide their dental care, no dentist will be able to avoid treating patients with medical problems altogether, and all dentists must be prepared for them. This book, which has been thoroughly updated in the present edition, provides an excellent overview of pathophysiology and treatment of a broad range of common medical conditions

that will provide the dentist with understanding of the interrelationships between patients' dental and medical care, as well as information on recommended modifications of treatment delivery. Competency in this critical and complex area of dentistry is essential to the safe and effective provision of dental care to an increasingly large part of our population. Its importance cannot be overstated.

John C. Robinson, MA, DDS, FAAOM
Santa Rosa, California

REFERENCES

1. Ward BW, Schiller JS, Goodman RA. Multiple chronic conditions among US adults: a 2012 update. *Prev Chronic Dis* 2014;11:130389.
2. CDC/National Center for Health Statistics. National Health Interview Survey. https://www.cdc.gov/nchs/health_policy/adult_chronic_conditions.htm.
3. Gu Q, Dillon CF, Burt VL. *Prescription drug use continues to increase: U.S. prescription drug data for 2007-2008*. NCHS data brief, no 42. Hyattsville, MD, 2010, National Center for Health Statistics.

The need for a ninth edition of *Dental Management of the Medically Compromised Patient* became apparent because of the continued, ever-increasing flow of new knowledge and changing concepts in medicine and dentistry.

The purpose of the book remains to give dental providers an up-to-date, concise, factual reference work describing the dental management of patients with medical problems. The more common medical disorders that may be encountered in a dental practice continue to be the focus. This book is not a comprehensive medical reference but rather a book containing enough core information about each of the medical conditions covered to enable readers to recognize the basis for various dental management recommendations. Medical problems are organized to provide a brief overview of the basic disease process, epidemiology, pathophysiology and complications, signs and symptoms, laboratory and diagnostic findings, and currently accepted medical therapy of each disorder. This is followed by a detailed explanation and recommendations for specific dental management and oral considerations.

The accumulation of evidence-based research over the years has allowed us to provide specific dental management guidelines that should benefit those who read this text. This includes practicing dentists, practicing dental hygienists, dental graduate students in specialty or general practice programs, and dental and dental hygiene students. In particular, the text is intended to give dental providers an understanding of how to identify a significant medical issue, ascertain the severity and stability of the disorder, and make dental management decisions that afford the patient the utmost health and safety.

An important feature of the book is access to the Evolve Resources for the ninth edition. These continue to be available at <https://evolve.elsevier.com> and include Evolve Student and Evolve Instructor Resources. Instructions for activating these resources are included. Working with our publisher, Elsevier, it is our goal to provide more information online via Evolve each year. This will allow dentists, dental hygienists, and students easy access to current information.

The “Dental Management: A Summary” at the front of the book is a very important resource because it is specific and to the point and serves as a current overview. This resource provides readers with a quick reference review with annotation of the corresponding chapter.

We are extremely pleased to welcome three experts who serve as contributing authors for this ninth edition:

Dr. Alexander Ross Kerr, clinical professor, Oral and Maxillofacial Pathology, Radiology, and Medicine, New York University, College of Dentistry; Dr. Eric T. Stoopler, associate professor and director of the Postdoctoral Oral Medicine Program, School of Dental Medicine, University of Pennsylvania, School of Dental Medicine; and Nathaniel Simon Treister, chief, Division of Oral Medicine and Dentistry, Brigham and Women’s Hospital and Dana-Farber Cancer Institute and assistant professor of Oral Medicine, Harvard School of Dental Medicine. Each of these authors made important contributions to this edition and reinvigorated our knowledge base. We are pleased and proud to have these authors as a part of our team.

NEW TO THIS EDITION

A number of major changes have been made in this ninth edition. Near the front of most chapters, a clear statement has been made in red type regarding the complications that may occur. **Chapter 1** presents the dental management and risk assessment process that is used as an important framework throughout the book. The Eighth Report of the Joint National Committee on Prevention, Detection, Evaluation, and Treatment of High Blood Pressure was added and explained in **Chapter 3**. **Chapter 17** has been expanded and renamed “Women’s Health Issues.” It includes in-depth discussions of osteoporosis, osteonecrosis, and drugs used during pregnancy and breastfeeding. The 2012 report of the American Dental Association/American Academy of Orthopaedic Surgeons on dental management of invasive dental procedures for patients with knee and hip replacements was added to **Chapter 20**. **Chapter 21** was completely rewritten with new tables and figures added. In **Chapters 28** and **29**, we made the decision not to use The American Psychiatric Association fifth edition of *Diagnostic and Statistical Manual of Mental Disorders* (DSM) that was published in 2013. The authors are aware of the implications of applying the new fifth edition of the DSM. We decided to postpone the application. This was based on the need to see how well accepted it becomes. Thus, in this ninth edition the fourth edition of the DSM is used.

All remaining chapters have been updated where necessary, and new dental considerations appear for steroid supplementation, antibiotic prophylaxis, and patients taking bisphosphonates. Some chapters have been provided with new color figures, boxes, and tables. Continued emphasis has been placed on the medications used to treat medical conditions. Dosages, side effects, and drug

interactions with agents used in dentistry—including those used during pregnancy and breastfeeding—are discussed in detail. Emphasis also has been placed on having contemporary equipment and diagnostic information to assess and monitor patients with moderate to severe medical disease.

Our sincere thanks and appreciation are extended to those many individuals who have contributed their time

and expertise to the writing and revision of this text. These include but are not limited to Brian Loehr, Jolynn Gower, Diane Chatman, and Kathy Falk as head of the Dental Division at Elsevier.

James W. Little
Craig S. Miller
Nelson L. Rhodus

Dental Management: A Summary, xiii

PART I Patient Evaluation and Risk Assessment, 1

- 1 Patient Evaluation and Risk Assessment, 2

PART II Cardiovascular Disease, 18

- 2 Infective Endocarditis, 19
- 3 Hypertension, 38
- 4 Ischemic Heart Disease, 53
- 5 Cardiac Arrhythmias, 70
- 6 Heart Failure (or Congestive Heart Failure), 86

PART III Pulmonary Disease, 100

- 7 Pulmonary Disease, 101
- 8 Smoking and Tobacco Use Cessation, 128
- 9 Sleep-Related Breathing Disorders, 138

PART IV Gastrointestinal Disease, 150

- 10 Liver Disease, 151
- 11 Gastrointestinal Disease, 176

PART V Genitourinary Disease, 192

- 12 Chronic Kidney Disease and Dialysis, 193
- 13 Sexually Transmitted Diseases, 210

PART VI Endocrine and Metabolic Disease, 229

- 14 Diabetes Mellitus, 230
- 15 Adrenal Insufficiency, 255
- 16 Thyroid Diseases, 268
- 17 Women's Health Issues, 288

PART VII Immunologic Disease, 308

- 18 AIDS, HIV Infection, and Related Conditions, 309
- 19 Allergy, 330
- 20 Rheumatologic Disorders, 345
- 21 Organ Transplantation, 370

PART VIII Hematologic and Oncologic Disease, 389

- 22 Disorders of Red Blood Cells, 390
- 23 Disorders of White Blood Cells, 402
- 24 Acquired Bleeding and Hypercoagulable Disorders, 428
- 25 Congenital Bleeding and Hypercoagulable Disorders, 457
- 26 Cancer and Oral Care of Patients With Cancer, 480

PART IX Neurologic, Behavioral, and Psychiatric Disorders, 515

- 27 Neurologic Disorders, 516
- 28 Anxiety and Eating Disorders, 544
- 29 Psychiatric Disorders, 561
- 30 Drug and Alcohol Abuse, 581

Appendices, 596

- A* Guide to Management of Common Medical Emergencies in the Dental Office, 597
- B* Guidelines for Infection Control in Dental Health Care Settings, 606
- C* Therapeutic Management of Common Oral Lesions, 623
- D* Drug Interactions of Significance in Dentistry, 639
- E* Drugs Used in Complementary and Alternative Medicine of Potential Importance in Dentistry, 645

Index, 655

Dental Management: A Summary

This table presents several important factors to be considered in the dental management of medically compromised patients. Each medical condition is outlined according to potential problems related to dental treatment, oral manifestations, prevention of problems, and complications potentially impacting on dental treatment.

This table has been designed for use by dentists, dental students, graduate students, dental hygienists, and dental assistants as a convenient reference work for the dental management of patients who have medical diseases discussed in this book.

POTENTIAL MEDICAL PROBLEM RELATED TO DENTAL CARE

Infective Endocarditis (IE) Chapter 2

- Dental procedures that involve the manipulation of gingival tissues or the periapical region of teeth or perforation of the oral mucosa can produce bacteremia. Bacteremias can also be produced on a daily basis as the result of toothbrushing, flossing, chewing, or the use of toothpicks or irrigating devices. Although it is unlikely that a single dental procedure-induced bacteremia will result in IE, it is remotely possible that it can occur.
- Patients with mechanical prosthetic heart valves may have excessive bleeding after invasive dental procedures as the result of anticoagulant therapy.

ORAL MANIFESTATIONS

- Oral petechiae may be found in patients with IE.

PREVENTION OF PROBLEMS

- Identify patients at greatest risk for adverse outcomes of IE, including patients with:
 - Prosthetic cardiac valves
 - A history of previous IE
 - Certain types of congenital heart disease (i.e., unrepaired cyanotic congenital heart disease, including patients with palliative shunts and conduits, completely repaired congenital heart disease for the first 6 months after a procedure, or repaired congenital heart disease with residual defect)
 - Cardiac transplantation recipients who develop cardiac valvulopathy
- Prescribe antibiotic prophylaxis only for at-risk patients, as listed, who undergo dental procedures that involve manipulation of gingival tissue or the periapical region of teeth or perforation of the oral mucosa.*
 - If prophylaxis is required for an adult, have the patient take a single dose 30 minutes to 1 hour before the procedure:
 - Standard (oral amoxicillin 2 g)
 - Allergic to penicillin (oral cephalixin 2 g, oral clindamycin† 600 mg, or azithromycin or clarithromycin 500 mg)
 - Unable to take oral medications (intravenous [IV] or intramuscular [IM] ampicillin, cefazolin, or ceftriaxone)
 - Allergic to penicillin and unable to take oral medications (IV or IM clindamycin phosphate, cefazolin, or ceftriaxone)
- See [Chapter 24](#) for management of potential bleeding problems associated with anticoagulant therapy.

TREATMENT PLANNING MODIFICATION(S)

- Encourage the maintenance of optimal oral hygiene in all patients at increased risk for IE.
- Provide antibiotic prophylaxis only for patients with the highest risk for adverse outcomes of IE.
- Provide antibiotic prophylaxis for all dental procedures, except:
 - Routine anesthetic injections
 - Taking of radiographs
 - Placement of removable prosthodontic or orthodontic appliances
 - Adjustment of orthodontic appliances
 - Shedding of deciduous teeth or bleeding from trauma to the lips or oral mucosa
- For patients selected for prophylaxis, perform as much dental treatment as possible during each coverage period.
- A second antibiotic dose may be indicated if the appointment lasts longer than 6 hours or if multiple appointments occur on the same day.
- For multiple appointments (on different days), allow at least 10 days between treatment sessions so that penicillin-resistant organisms can “clear” from the oral flora. If treatment becomes necessary before 10 days have passed, select one of the alternative antibiotics for prophylaxis.
- For patients with prosthetic heart valves who are taking anticoagulants, the dosage may have to be reduced on the basis of international normalized ratio (INR) level and the degree of invasiveness of the planned procedure (see [Chapter 24](#)).
- Detection of patients with hypertension and referral to a physician if poorly controlled or uncontrolled. Defer elective dental treatment if blood pressure (BP) is $\geq 180/110$ mm Hg.
- For patients who are being treated for hypertension, consider the following:
 - Take measures to reduce stress and anxiety.
 - Avoid the use of erythromycin or clarithromycin in patients taking a calcium channel blocker.
 - Avoid the long-term use of nonsteroidal antiinflammatory drugs (NSAIDs).
 - Provide oral sedative premedication or inhalation sedation (or both).
 - Provide local anesthesia of excellent quality.
- For patients who are taking a nonselective beta blocker, limit epinephrine to ≤ 2 cartridges of 1:100,000 epinephrine.
- Avoid epinephrine-containing gingival retraction cord.
- For patients with upper-level stage 2 hypertension, consider intraoperative monitoring of BP and terminate appointment if BP reaches 180/110 mm Hg.
- Make slow changes in chair position to avoid orthostatic hypotension.

*It is of interest that in Great Britain, they had to return to antibiotic prophylaxis for patients considered not to be at risk.

†Cephalexin should not be used in patients with a history of anaphylaxis, angioedema, or urticaria with penicillins.

POTENTIAL MEDICAL PROBLEM RELATED TO DENTAL CARE	ORAL MANIFESTATIONS	PREVENTION OF PROBLEMS	TREATMENT PLANNING MODIFICATION(S)
<p>Hyperthyroidism (Thyrotoxicosis) Chapter 16</p> <p>1. Thyrotoxic crisis (thyroid storm) may be precipitated in patients with untreated or incompletely treated thyrotoxicosis by:</p> <ol style="list-style-type: none"> Infection Trauma Surgical procedures Stress <p>2. Patients with untreated or incompletely treated thyrotoxicosis may be very sensitive to actions of epinephrine and other pressor amines; thus, these agents must not be used. After the patient is well managed from a medical standpoint, these agents may be administered.</p> <p>3. Thyrotoxicosis increases the risk for hypertension, angina, myocardial infarction (MI), congestive heart failure, and severe arrhythmias.</p> <p>4. Radioactive iodine complications</p> <p>5. Antithyroid agents: propylthiouracil, methimazole</p>	<ul style="list-style-type: none"> Osteoporosis may occur. Periodontal disease may be more progressive. Dental caries may be more extensive. Premature loss of deciduous teeth and early eruption of permanent teeth may occur. Early jaw development may be noted. Tumors found at the midline of the posterior dorsum of the tongue must not be surgically removed until the possibility of functional thyroid tissue has been ruled out by ¹³¹I uptake tests. Acute—salivary gland swelling, pain, loss of taste Radioactive drug-induced: Chronic sialoadenitis—xerostomia, pain, and dental caries Sore throat, fever, mouth ulcers 	<ul style="list-style-type: none"> Detection of patients with thyrotoxicosis by history and examination findings Referral for medical evaluation and treatment Avoidance of any dental treatment for patient with thyrotoxicosis until good medical control is attained; however, any acute oral infection will have to be dealt with by antibiotic therapy and other conservative measures to prevent development of thyrotoxic crisis; suggest consultation with patient's physician during management of acute oral infection Avoidance of epinephrine and other pressor amines in untreated or incompletely treated patients Recognition of early stages of thyrotoxic crisis: <ul style="list-style-type: none"> Severe symptoms of thyrotoxicosis Fever Abdominal pain Delirious, obtunded, or psychotic Initiation of immediate emergency treatment procedures: <ul style="list-style-type: none"> Seek immediate medical aid. Cool with cold towels, ice packs. Hydrocortisone (100–300 mg) Monitor vital signs. Start cardiopulmonary resuscitation (CPR) if needed. Manage pain and xerostomia as described in Appendix C. Possible agranulocytosis; refer to physician for evaluation and stopping the antithyroid medication. 	<ul style="list-style-type: none"> When under good medical management, the patient may receive any indicated dental treatment. If acute infection occurs, the physician should be consulted regarding management.

Continued

POTENTIAL MEDICAL PROBLEM RELATED TO DENTAL CARE	ORAL MANIFESTATIONS	PREVENTION OF PROBLEMS	TREATMENT PLANNING MODIFICATION(S)
Hypothyroidism Chapter 16			
1. Untreated patients with severe hypothyroidism exposed to stressful situations such as trauma, surgical procedures, or infection may develop hypothyroid (myxedema) coma.	<ul style="list-style-type: none"> • Increased tongue size • Delayed eruption of teeth • Malocclusion • Gingival edema 	<ul style="list-style-type: none"> • Detection and referral of patients suspected of being hypothyroid for medical evaluation and treatment • Avoidance of narcotics, barbiturates, and tranquilizers in untreated hypothyroid patients • Recognition of initial stage of hypothyroid (myxedema) coma: <ul style="list-style-type: none"> • Hypothermia • Bradycardia • Hypotension • Epileptic seizures • Initiation of immediate treatment for myxedema coma: <ul style="list-style-type: none"> • Seek immediate medical aid. • Administer hydrocortisone (100–300 mg). • Provide CPR as indicated. 	<ul style="list-style-type: none"> • In hypothyroid patients under good medical management, indicated dental treatment may be performed. • In patients with a congenital form of disease and severe mental retardation, assistance with hygienic procedures may be needed.
2. Untreated hypothyroid patients may be highly sensitive to actions of narcotics, barbiturates, and tranquilizers.			
3. May have comorbidities: hypercholesterolemia, or bleeding issues			
Thyroiditis Chapter 16			
1. <i>Acute suppurative</i> —patient has acute infection; antibiotics are required.	<ul style="list-style-type: none"> • Usually none 		<ul style="list-style-type: none"> • Postpone elective dental care until infection has been treated.
2. <i>Subacute painful</i> —period of hyperthyroidism	<ul style="list-style-type: none"> • Pain may be referred to mandible. • None 	<ul style="list-style-type: none"> • Include in differential diagnosis for jaw pain; see earlier under Hyperthyroidism. • See earlier under Hyperthyroidism. 	<ul style="list-style-type: none"> • Avoid elective dental care if possible until symptoms of hyperthyroidism have cleared. • Avoid elective dental care if possible until symptoms of hyperthyroidism have cleared.
3. <i>Subacute painless</i> —up to 6-month period of hyperthyroidism			
4. <i>Hashimoto</i> —leads to severe hypothyroidism	<ul style="list-style-type: none"> • Tongue may be enlarged. 	<ul style="list-style-type: none"> • See earlier under Hypothyroidism. 	<ul style="list-style-type: none"> • In hypothyroid patients under good medical management, any indicated dental treatment can be performed. See above for uncontrolled disease. • None
5. <i>Chronic fibrosing (Riedel)</i> —usually euthyroid	<ul style="list-style-type: none"> • None 		

POTENTIAL MEDICAL PROBLEM RELATED TO DENTAL CARE	ORAL MANIFESTATIONS	PREVENTION OF PROBLEMS	TREATMENT PLANNING MODIFICATION(S)
<p>Thyroid Cancer Chapter 16</p> <p>1. Usually none</p>	<ul style="list-style-type: none"> • Usually none; metastasis to the oral cavity is rare. • Postradiation-induced chronic sialadenitis, xerostomia, risk for root caries. 	<ul style="list-style-type: none"> • Examine for signs and symptoms of thyroid cancer: <ul style="list-style-type: none"> • Hard, painless lump in thyroid • Dominant nodule in multinodular goiter • Hoarseness, dysphagia, dyspnea • Cervical lymphadenopathy • Nodule that is affixed to underlying tissues • Patient usually euthyroid • Patients found to have thyroid nodule(s) should be referred for fine-needle aspiration biopsy. • Consult with patient's physician regarding permissible degree of hyperthyroidism in patients treated with thyroid hormone. 	<ul style="list-style-type: none"> • For most patients, the dental treatment plan is not affected unless the cancer treatment includes external irradiation or chemotherapy. See summaries for Chapter 26. • Patients with anaplastic carcinoma have a poor prognosis, and complex dental procedures usually are not indicated.
<p>2. Levothyroxine suppression after surgery and radioiodine ablation is the usual treatment for follicular carcinomas. The patient may have mild hyperthyroidism and may be sensitive to actions of pressor amines.</p>	<ul style="list-style-type: none"> • Usually none 		<ul style="list-style-type: none"> • Care with the use of epinephrine is indicated in patients made to be hyperthyroid as part of their cancer treatment regimen.
<p>3. Patients with multiple endocrine neoplasia-2 (MEN2) may have symptoms of hypertension, hypercalcemia, or both.</p>	<ul style="list-style-type: none"> • Patients with MEN2 can develop cystic lesions of the jaws related to hyperparathyroidism. 		
<p>4. Anaplastic carcinomas may be treated by external irradiation, chemotherapy, or both. See problems listed in summaries for Chapter 26.</p>	<ul style="list-style-type: none"> • See oral complications listed in summaries for Chapter 26. 	<ul style="list-style-type: none"> • Manage complications of radiation therapy and chemotherapy as described in summaries for Chapter 26. 	<ul style="list-style-type: none"> • Prognosis is poor with anaplastic carcinoma.

Continued

POTENTIAL MEDICAL PROBLEM RELATED TO DENTAL CARE	ORAL MANIFESTATIONS	PREVENTION OF PROBLEMS	TREATMENT PLANNING MODIFICATION(S)
Iron Deficiency Anemia <i>Chapter 22</i>			
<ol style="list-style-type: none"> Usually none In rare cases, severe leukopenia and thrombocytopenia may result in problems with infection and excessive loss of blood. 	<ul style="list-style-type: none"> Paresthesias Loss of papillae on dorsum of tongue In rare cases, infection and bleeding complications In patients with dysphagia, increased incidence of carcinoma of oral and pharyngeal areas (Plummer-Vinson syndrome) 	<ul style="list-style-type: none"> Detection and referral for diagnosis and treatment Recognition that in women, most cases are caused by physiologic process—menstruation or pregnancy Recognition that in men, most cases are the result of underlying disease—peptic ulcer, carcinoma of colon, other—requiring referral to the patient's physician 	<ul style="list-style-type: none"> Usually none indicated
Glucose-6-Phosphate Dehydrogenase (G-6-PD) Deficiency <i>Chapter 22</i>			
<ol style="list-style-type: none"> Accelerated hemolysis of red blood cells 	<ul style="list-style-type: none"> Usually none 	<ul style="list-style-type: none"> Control infection. Avoid drugs such as certain antibiotics or that contain aspirin or acetaminophen, which may increase risk for hemolytic anemia. Be aware that these patients also often have increased sensitivity to the actions of sulfa drugs and chloramphenicol. 	<ul style="list-style-type: none"> Usually none unless anemia is severe; then perform only procedures to meet urgent dental needs.
Pernicious Anemia <i>Chapter 22</i>			
<ol style="list-style-type: none"> Infection Bleeding Delayed healing 	<ul style="list-style-type: none"> Paresthesias of oral tissues (burning, tingling, numbness) Delayed healing (severe cases), infection, bald red tongue, angular cheilitis Petechial hemorrhages 	<ul style="list-style-type: none"> Detection and medical treatment (early detection and treatment can prevent permanent neurologic damage) 	<ul style="list-style-type: none"> None indicated when the patient is under medical care

POTENTIAL MEDICAL PROBLEM RELATED TO DENTAL CARE	ORAL MANIFESTATIONS	PREVENTION OF PROBLEMS	TREATMENT PLANNING MODIFICATION(S)
Sickle Cell Anemia Chapter 22 1. Sickle cell crisis	<ul style="list-style-type: none"> • Atypical trabecular pattern • Delayed eruption of teeth, growth abnormalities • Hypoplasia of teeth • Pallor of oral mucosa • Jaundice of oral mucosa • Bone pain • Osteoporosis 	<ul style="list-style-type: none"> • Consult with patient's physician to ensure that condition is stable. • Institute aggressive preventive dental care. • Avoid any procedure that may produce acidosis or hypoxia (avoid long, complicated procedures). • Drug modifications: <ul style="list-style-type: none"> • Avoid excessive use of barbiturates and narcotics because suppression of the respiratory center may occur, leading to acidosis, which can precipitate acute crisis. Use benzodiazepine instead. • Avoid excessive use of salicylates because "acidosis" may result, again leading to possible acute crisis; codeine and acetaminophen in moderate dosage can be used for pain control. • Avoid the use of general anesthesia because hypoxia can lead to precipitation of acute crisis. • Nitrous oxide may be used, provided that 50% oxygen is supplied at all times; it is critical to avoid diffusion hypoxia at the termination of nitrous oxide administration. For nonsurgical procedures, use local without vasoconstrictor; for surgical procedures, use 1:100,000 epinephrine in anesthetic solution. 	<ul style="list-style-type: none"> • Usually none unless symptoms of severe anemia are present; then only urgent dental needs should be met.
		<ol style="list-style-type: none"> 1. Aspirate before injecting. 2. Inject slowly. 3. Use no more than two cartridges. 4. It is necessary to prevent infection. Use prophylactic antibiotics for major surgical procedures. 5. If infection occurs, manage aggressively, with the use of: <ol style="list-style-type: none"> a. Heat b. Incision and drainage c. Antibiotics d. Corrective treatment (e.g., extraction, pulpectomy) 6. Avoid dehydration in patients with infection and in patients who are receiving surgical treatment. 	

Continued

POTENTIAL MEDICAL PROBLEM RELATED TO DENTAL CARE

ORAL MANIFESTATIONS

PREVENTION OF PROBLEMS

TREATMENT PLANNING MODIFICATION(S)

Aplastic Anemia

Chapter 22

1. Bleeding
 - Gingival bleeding
 - Petechiae
 - Ecchymosis
2. Infection
 - Oral infection
 - Pallor of mucosa

- Referral for medical diagnosis and treatment
- Medical consultation to determine current status of the patient under medical treatment
- Some drugs (anticonvulsants, antithyroid drugs, select antidiabetic agents, diuretics, and sulfonamides) are associated with higher incidence of aplastic anemia.

- During periods of low blood count (platelets, neutrophils, red blood cells), provide emergency care only.

- Antimicrobial agents and supportive therapy are needed for oral infection (see [Appendix C](#) for specific treatment regimens).

Agranulocytosis

Chapter 23

1. Infection
 - Oral ulcerations
 - Periodontitis
 - Necrotic tissue

- Referral for medical diagnosis and treatment
- Drug considerations—some antibiotics (macrolides, penicillins, and cephalosporins) used for oral infections are associated with higher incidence of agranulocytosis. Avoid these antibiotics if possible.

- During periods of low white blood (WBC) counts, provide emergency care only. Treatment should include the use of antimicrobial agents and supportive therapy for oral lesions (see [Appendix C](#) for specific treatment regimens).

Cyclic Neutropenia

Chapter 23

1. Infection
 - Periodontal disease
 - Oral infection
 - Oral ulceration similar to aphthous stomatitis

- Antibiotics should be given to prevent infection.
- Serial WBC counts should be performed to identify the safest period for dental treatment (i.e., when the WBC count is closest to normal level).

- Modifications not required when the WBC count (neutrophils) is normal.
- If the WBC count (neutrophils) is depressed severely, antibiotics should be provided to prevent postoperative infection.

Leukemia

Chapter 23

1. Infection
2. Bleeding
3. Delayed healing
4. Mucositis

- Referral for medical diagnosis, treatment, and consultation
- Complete blood count to determine risk for anemia, bleeding, and infection
- Antibiotics, antivirals, and antifungals provided during chemotherapy to prevent opportunistic oral infection
- Chlorhexidine rinses or bland rinses to manage mucositis

- Inspect head, neck, and radiographs for undiagnosed or latent disease (e.g., retained root tips, impacted teeth) and infections that require management before chemotherapy.
- Eliminate infections before chemotherapy.
- Extractions should be performed at least 10 days before initiation of chemotherapy.
- Implement plaque control measures and chlorhexidine during chemotherapy.
- Use prophylactic antibiotics if WBC count is less than 2000/ μL or neutrophil count is less than 500/ μL (or 1000/ μL at some institutions).
- Platelet replacement may be required (if platelet count is <50,000/ μL) when invasive dental procedures are performed.

POTENTIAL MEDICAL PROBLEM RELATED TO DENTAL CARE	ORAL MANIFESTATIONS	PREVENTION OF PROBLEMS	TREATMENT PLANNING MODIFICATION(S)
<p>Multiple Myeloma Chapter 23</p> <ol style="list-style-type: none"> Excessive bleeding after invasive dental procedures Risk of infection because of decrease in normal immunoglobulins Risks of infection and bleeding in patients who are being treated by irradiation or chemotherapy Risk of osteonecrosis of the jaws in patients who are taking bisphosphonates (especially intravenously) as well as other antiangiogenic medications 	<ul style="list-style-type: none"> Soft tissue tumors Osteolytic jaw lesions Amyloid deposits in soft tissues Unexplained mobility of teeth Exposed bone 	<ul style="list-style-type: none"> Patients with oral soft tissue lesions or osseous lesions should have them biopsied by the dentist or should be referred for diagnosis and treatment as indicated. Medical history should identify patients with diagnosed disease; medical consultation is needed to establish current status. (See sections on chemotherapy and radiation therapy on prevention and management of medical complications.) Be aware of and take precautions for medication-related osteonecrosis of the jaws. 	<ul style="list-style-type: none"> For patients in terminal stage, provide supportive dental care only. With the newer therapies, the long-term prognosis has been greatly improved, so complex dental procedures may be considered. If thrombocytopenia or leukopenia is present, special precautions (platelet replacement, antibiotic therapy) are needed to prevent bleeding and infection when invasive dental procedures are performed. Patients may be bleeders because of the presence of abnormal immunoglobulin M macroglobulins, which form complexes with clotting factors, thereby inactivating the clotting factors. (See sections on chemotherapy and radiation therapy for treatment plan modifications.)
<p>Lymphomas: Hodgkin Disease, Non-Hodgkin Lymphoma, Burkitt Lymphoma Chapter 23</p> <ol style="list-style-type: none"> Increased risk for infection Risks of infection and excessive bleeding in patients receiving chemotherapy Minor risk of osteonecrosis in patients treated by radiation to the head and neck region (usually does not occur because radiation dosage seldom exceeds 50 Gy) Hyposalivation and xerostomia may occur in patients treated by irradiation (>25 Gy) to the head and neck region. Non-Hodgkin lymphoma may be found in patients with AIDS; hence, transmission of infectious agents may be a problem. 	<ul style="list-style-type: none"> Extranodal oral tumors in Waldeyer ring or osseous soft tissues Xerostomia in patients treated by radiation; some of these patients prone to osteonecrosis Burning mouth or tongue symptoms Petechiae or ecchymoses if thrombocytopenia present because of tumor invasion of bone marrow Cervical lymphadenopathy Mucositis in patients treated by radiation therapy or chemotherapy 	<ul style="list-style-type: none"> Patients with generalized lymphadenopathy, extranodal tumors, and osseous lesions must be identified and referred for medical evaluation and treatment. The dentist can biopsy extranodal or osseous lesions to establish a diagnosis; patients with lesions involving the lymph nodes should be referred for excisional biopsy. Medical history should identify patients with diagnosed disease; medical consultation is needed to establish current status. (See sections on chemotherapy and radiation therapy on management and prevention of medical complications.) Before invasive procedures, a complete blood count should be obtained to determine risks for bleeding and infection. Patients who have been treated by irradiation to the chest area may develop acute and chronic cardiovascular complications such as arrhythmias or valvular heart disease. Medical consultation is needed to confirm their current status. 	<ul style="list-style-type: none"> Patients in terminal phase should receive only supportive dental treatment. Patients under “control” may receive any indicated treatment; however, complex restorative treatment may not be indicated in cases with a poor prognosis. Platelet replacement may be needed for patients with thrombocytopenia. (See sections on radiation therapy and chemotherapy for treatment plan modifications.) Consider prophylactic antibiotics if the WBC count is less than 2000/μL or the neutrophil count is less than 500 (or 1000/μL at some institutions).

Continued

POTENTIAL MEDICAL PROBLEM
RELATED TO DENTAL CARE

ORAL MANIFESTATIONS

PREVENTION OF PROBLEMS

TREATMENT PLANNING MODIFICATION(S)

Bleeding Problem Suggested by Examination and History Findings But Lack of Clues to Underlying Cause
Chapter 24

- Excessive blood loss after surgical procedures, scaling, other manipulations
 - Excessive bleeding after dental procedures
 - Screen patients with the following (if results of one or more tests are abnormal, refer for diagnosis and medical treatment):
 - Prothrombin time
 - Activated partial thromboplastin time
 - Thrombin time
 - Platelet count
 - Avoid use of aspirin and related drugs.

Thrombocytopenia (Primary or Secondary) Caused by Chemicals, Radiation, or Leukemia
Chapter 24

- Prolonged bleeding
 - Infection in patients with bone marrow replacement or destruction
 - A medical emergency can result from stress in patients being treated with steroids.
 - Spontaneous bleeding
 - Prolonged bleeding after certain dental procedures
 - Petechiae
 - Ecchymoses
 - Hematomas
- Identification of patients to include the following:
 - History
 - Examination findings
 - Screening tests—platelet count
 - Referral and consultation with a hematologist
 - Correction of underlying problem or replacement therapy before surgery
 - Local measures to control blood loss (e.g., splint, Gelfoam, thrombin)
 - Prophylactic antibiotics may be considered in surgical cases to prevent postoperative infection if severe neutropenia is present.
 - Additional steroids should be used for patients being treated with steroids, if indicated (see section on adrenal insufficiency).
 - Aspirin, other NSAIDs, and aspirin-containing compounds are not to be used; acetaminophen (Tylenol) with or without codeine may be used if analgesia is required.
- In general, dental procedures can be performed if the platelet count is 30,000/ μ L or higher.
 - Extractions and minor surgery can be performed if the platelet count is 50,000/ μ L or higher.
 - Major oral surgery can be performed if the platelet count is 80,000/ μ L to 100,000/ μ L or higher.
 - Platelet transfusion is needed for patients with platelet counts below the above values.
 - Patients with severe neutropenia (500/ μ L or less) may require antibiotics for certain surgical procedures (1000/ μ L at some institutions).
 - In children with primary thrombocytopenia, many will respond to steroids with increase in platelets to levels, allowing dental procedures to be performed.

POTENTIAL MEDICAL PROBLEM RELATED TO DENTAL CARE	ORAL MANIFESTATIONS	PREVENTION OF PROBLEMS	TREATMENT PLANNING MODIFICATION(S)
Vascular Wall Alterations (Scurvy, Infection, Chemical, Allergic, Autoimmune, Other Agents or Factors) <i>Chapter 24</i>	<ul style="list-style-type: none"> Excessive bleeding after surgical and surgical procedures Petechiae Ecchymoses Hematomas 	<ul style="list-style-type: none"> Identification of patients should include the following: <ul style="list-style-type: none"> History Clinical findings Screening tests—none reliable Consultation with a hematologist should be obtained. Local measures should be used to control blood loss: splints, Gelfoam, Oxyeel, and surgical thrombin (see Table 24.6). Prevention of allergy if causative and if the antigen is identified 	<ul style="list-style-type: none"> Surgical procedures must be avoided in these patients unless the underlying problem has been corrected or the patient has been prepared for surgery by a hematologist and the dentist is prepared to control excessive loss of blood through local measures: splints, thrombin, microfibrillar collagen, Gelfoam, Oxyeel, ε-aminocaproic acid (Amicar) (see Table 24.6).
Acquired Disorders of Coagulation (Liver Disease, Broad-Spectrum Antibiotics, Malabsorption Syndrome, Biliary Tract Obstruction, Heparin, Other Agents or Factors) <i>Chapter 24</i>	<ul style="list-style-type: none"> Excessive bleeding Spontaneous bleeding Petechiae Hematomas 	<ul style="list-style-type: none"> Identification of patients with such disorders should include: <ul style="list-style-type: none"> History Examination findings Screening laboratory tests—prothrombin time (prolonged) in liver disease, platelet count (low if hypersplenism present) Consultation and referral should be provided. Preparation before the dental procedure may include vitamin K injection by the physician and platelet replacement if indicated. Local measures are used to control blood loss (see Table 24.6). For patients with liver disease, avoid or reduce dosage of drugs metabolized by the liver. Do not use aspirin, other NSAIDs, or aspirin-containing compounds. 	<ul style="list-style-type: none"> No dental procedures should be performed unless the patient has been prepared on the basis of a consultation with a hematologist.

Continued

POTENTIAL MEDICAL PROBLEM
RELATED TO DENTAL CARE

ORAL MANIFESTATIONS

PREVENTION OF PROBLEMS

TREATMENT PLANNING MODIFICATION(S)

Anticoagulation with Coumarin Drugs (Warfarin)
Chapter 24

1. Excessive bleeding after dental procedures that result in soft tissue or osseous injury

- Excessive bleeding
- Hematomas
- Petechiae
- In rare cases, spontaneous bleeding

- Identify patients who are taking anticoagulants or coumarin in the following ways:
 - History
 - Screening laboratory test—INR, prothrombin time

- Consultation should be obtained regarding level of anticoagulation:

- If INR is 3.5 or less, most surgical procedures can be performed.

- Dosage of anticoagulant should be reduced if INR is greater than 3.5. (It takes several days for INR to fall to desired level; confirmation should be obtained by new tests before surgery is completed.)

- Patients undergoing major oral surgery should be managed on an individual basis; in most cases, INR should be below 3.0 at the time of surgery.

- Low-molecular-weight heparin bridging can be considered for major surgery.

- ε-Aminocaproic acid (Amicar) rinses, just before surgery and every hour for 6–8 hours, will aid in control of bleeding. Local measures should be instituted to control blood loss after surgery (see [Table 24.6](#)).

- Dental procedures should not be performed unless medical consult has been obtained and level of anticoagulation is at an acceptable range; the procedure may have to be delayed by 2 to 3 days if the dosage of anticoagulant has to be reduced.
- Avoid aspirin and aspirin-containing compounds. Use acetaminophen (Tylenol) for postoperative pain control.

POTENTIAL MEDICAL PROBLEM
RELATED TO DENTAL CARE

ORAL MANIFESTATIONS

PREVENTION OF PROBLEMS

TREATMENT PLANNING MODIFICATION(S)

Disseminated Intravascular Coagulation (DIC)
Chapter 24

- Excessive bleeding after invasive dental procedures; in chronic form of disease, widespread thrombosis may occur.
 - Spontaneous gingival bleeding
 - Petechiae
 - Ecchymoses
 - Prolonged bleeding after invasive dental procedures
- Depending on the cause of DIC, the treatment plan should be altered as follows:
- With acute DIC—No routine dental care until medical evaluation and correction of cause
 - With chronic DIC—No routine dental care until medical evaluation and correction of cause when possible; if prognosis is poor on the basis of underlying cause (advanced cancer), limited dental care is indicated.
 - Avoid aspirin, other NSAIDs, and aspirin-containing compounds.
 - Do not use ε-aminocaproic acid (Amicar), tranexamic acid, or desmopressin because these agents may complicate the disorder and result in increased bleeding.
 - Acetaminophen with or without codeine can be used for postoperative pain.
- Identification of patients includes the following:
- History—excessive bleeding after minor trauma; spontaneous bleeding from nose, gingiva, gastrointestinal tract, urinary tract; recent infection, burns, shock and acidosis, or autoimmune disease; history of cancer most often associated with chronic form of disseminated intravascular coagulation (DIC), in which thrombosis rather than bleeding usually is the major clinical problem
 - Examination findings include the following:
 - Petechiae
 - Ecchymoses
 - Spontaneous gingival bleedings; bleeding from nose, ears, and so on.
 - Screening laboratory findings include the following:
 - Acute DIC—prothrombin time (prolonged), partial thromboplastin time (prolonged), thrombin time (prolonged), platelet count (decreased)
 - Chronic DIC—most test results may be normal, but fibrin-split products are present (positive result on D-dimer test).
- Obtain referral and consultation with physician if invasive dental procedures must be performed, and include information on:
- Acute DIC—cryoprecipitate, fresh frozen plasma, and platelets
 - Chronic DIC—anticoagulants such as heparin or vitamin K antagonists
 - Aspirin or aspirin-containing products are prohibited.
 - Local measures are used to control bleeding (see [Table 24.6](#)).
 - Antibiotic therapy may be considered to prevent postoperative infection.

Continued

POTENTIAL MEDICAL PROBLEM RELATED TO DENTAL CARE

ORAL MANIFESTATIONS

PREVENTION OF PROBLEMS

TREATMENT PLANNING MODIFICATION(S)

Disorders of Platelet Release

Chapter 24

- Excessive bleeding after invasive dental procedures
 - Excessive bleeding may occur after surgery.
 - Petechiae, ecchymoses, and hematomas may be found when other platelet or coagulation disorders are present.
- Identification of patient should include the following:
 - History—recent use of aspirin, indomethacin, phenylbutazone, ibuprofen, or sulfinpyrazone; presence of other platelet or coagulation disorders
 - Examination—often negative unless signs related to other platelet or coagulation disorders are present
 - Screening laboratory tests—partial thromboplastin time (prolonged)
 - Most patients on drugs noted above without an additional platelet or coagulation problem will not bleed excessively after surgery.
 - Patients with prolonged partial thromboplastin time should be referred for evaluation before performance of any surgical procedures.
 - Elective surgery can be performed after withdrawal of drug for at least 3 days and management of other platelet or coagulation disorders by appropriate means.

- Usually, no modifications are indicated for patients who have no other platelet or coagulation disorders.

Primary Fibrinogenolysis

Chapter 24

- Excessive bleeding after invasive dental procedures
 - Prolonged bleeding after invasive dental procedures
 - Jaundice of mucosa
 - Ecchymoses
- Identification of patients should include the following:
 - History—liver disease, cancer of lung, cancer of prostate, and heat stroke may cause this condition.
 - Examination findings to consider:
 - Jaundice
 - Spider angiomas
 - Ecchymoses
 - Hematomas
 - Screening laboratory tests:
 - Platelet count (often normal)
 - Prothrombin time (prolonged)
 - Partial thromboplastin time (prolonged)
 - Thrombin time (prolonged)
 - Consultation and referral before any invasive dental procedure; ε-aminocaproic acid therapy will inhibit plasmin and plasmin activators.
- Patients with advanced cancer should have treatment limited to emergency dental procedures and preventive measures; complex dental restorations in general are not indicated; in other patients, after preparation to avoid excessive bleeding has occurred (ε-aminocaproic acid), most dental treatment can be rendered.

POTENTIAL MEDICAL PROBLEM RELATED TO DENTAL CARE	ORAL MANIFESTATIONS	PREVENTION OF PROBLEMS	TREATMENT PLANNING MODIFICATION(S)
Low-Molecular-Weight Heparin Therapy: Enoxaparin (Lovenox), Ardeparin (Normiflo), Dalteparin (Fragmin), Nadroparin (Fraxiparine), Reviparin (Clivarin), Tinzaparin (Innohep) Chapter 24			
1. Used in patients who have received prosthetic knee or hip replacement; patient takes medication for approximately 2 weeks after getting out of the hospital	<ul style="list-style-type: none"> • Gingival bleeding • Petechiae • Ecchymoses • In rare cases, excessive bleeding after dental procedures 	<ul style="list-style-type: none"> • Delay procedure until patient is off the medication. • Have physician stop medication and perform surgery the next day; when hemostasis is obtained, have the physician resume medication. • Perform surgery and manage any excessive bleeding through local means (preferred if excessive bleeding is not anticipated). 	<ul style="list-style-type: none"> • Usually none needed
2. Complications include the following: <ol style="list-style-type: none"> a. Excessive bleeding b. Anemia c. Fever d. Thrombocytopenia e. Peripheral edema 			
Antiplatelet Drug Therapy: Aspirin, Aspirin Plus Dipyridamole (Aggrenox), Ibuprofen (Advil, Motrin) Chapter 24			
1. Used for prevention of initial or recurrent MI and stroke prevention	<ul style="list-style-type: none"> • Gingival bleeding • Petechiae • Ecchymoses • In rare cases, excessive bleeding after dental procedures 	<ul style="list-style-type: none"> • If no other complications occur, dental procedures and surgery can usually be performed. 	<ul style="list-style-type: none"> • Usually none needed unless there are other medical problems, such as recent MI or stroke.
2. Complications include: <ol style="list-style-type: none"> a. Excessive bleeding b. Gastrointestinal bleeding c. Tinnitus d. Bronchospasm 			
Fibrinogen Receptor Therapy (Glycoprotein [GP] IIb/IIIa inhibitors—Abciximab, Tirofiban): ADP (Adenosine Diphosphate) Inhibitors (Clopidogrel [Plavix], Ticlopidine [Ticlid]) Chapter 24			
1. Used for prevention of recurrent MI and stroke	<ul style="list-style-type: none"> • Gingival bleeding • Petechiae • Ecchymoses • In rare cases, excessive bleeding after dental procedures • Adverse reactions increase risk for infection (neutropenia) and bleeding (thrombocytopenia). 		<ul style="list-style-type: none"> • Usually none needed, unless there are other medical problems such as recent MI or stroke. • The American Diabetes Association and American Heart Association issued a statement that dual-antiplatelet treatment (clopidogrel and aspirin) should not be discontinued for patients with stents when receiving invasive dental treatment.
2. Complications include: <ol style="list-style-type: none"> a. Excessive bleeding b. Gastrointestinal bleeding c. Neutropenia d. Thrombocytopenia 			

Continued

POTENTIAL MEDICAL PROBLEM
RELATED TO DENTAL CARE

ORAL MANIFESTATIONS

PREVENTION OF PROBLEMS

TREATMENT PLANNING MODIFICATION(S)

Congenital Disorders of Coagulation (Hemophilia)
Chapter 25

- | | | |
|---|---|--|
| <ol style="list-style-type: none"> 1. Excessive bleeding after dental procedures 2. HIV, hepatitis B virus-, and hepatitis C virus-infected patients are potentially infectious (see Appendix B). | <ul style="list-style-type: none"> • Spontaneous bleeding • Prolonged bleeding after dental procedures that injure soft tissue or bone • Hematomas • Oral lesions associated with HIV infection in patients who receive infected replacement products (most cases occurred before 1986) | <ul style="list-style-type: none"> • Identification of patients includes the following: <ul style="list-style-type: none"> • History—bleeding problems in relatives, excessive bleeding after trauma or surgery • Examination findings: <ol style="list-style-type: none"> 1. Ecchymoses 2. Hemarthrosis 3. Dissecting hematomas • Screening tests—prothrombin time (normal), activated partial thromboplastin time (prolonged), thrombin time (normal), platelet count (normal) • Consultation and referral should be provided for diagnosis and treatment and for preparation before dental procedures are performed. • Replacement options include the following: <ul style="list-style-type: none"> • Cryoprecipitate (used rarely) • Fresh frozen plasma (used rarely) • Factor VIII concentrates, including: <ol style="list-style-type: none"> 1. Heat-treated concentrate 2. Purified factor VIII 3. Recombinant factor VIII 4. Porcine factor VIII • For mild to moderate factor VIII deficiency, consider using: <ol style="list-style-type: none"> 1. 1-Desamino-8-D-arginine vasopressin (desmopressin) (oral or nasal) 2. ε-Aminocaproic acid (Amicar) rinse or taken orally 3. Tranexamic acid (Cyklokapron); oral solution not available in the United States; injectable and tablets are available • Factor VIII replacement may be needed for some patients with mild to moderate factor VIII deficiency. • Often treated on an outpatient basis |
|---|---|--|

- No dental procedures should be performed unless the patient has been prepared on the basis of consultation with a hematologist.
- Avoid aspirin, other NSAIDs, and aspirin-containing compounds; use acetaminophen (Tylenol) with or without codeine.

POTENTIAL MEDICAL PROBLEM RELATED TO DENTAL CARE	ORAL MANIFESTATIONS	PREVENTION OF PROBLEMS	TREATMENT PLANNING MODIFICATION(S)
		<ul style="list-style-type: none"> • For severe factor VIII deficiency, alleviate with such measures as: <ul style="list-style-type: none"> • Agents used above for mild to moderate deficiency • Higher dose(s) of factor VIII • Patients who are low responders (low antibody response to FVIII): <ul style="list-style-type: none"> • Very high dose(s) of factor VIII • Patients who are high responders (high antibody response to FVIII): <ul style="list-style-type: none"> • No elective surgery • Agents used for mild to moderate deficiency • High doses of porcine factor VIII concentrate • Nonactivated prothrombin/complex concentrate • Activated prothrombin/complex concentrate • Plasmapheresis • Factor VIIa • Steroids • In rare cases, plasmapheresis 	
		<ul style="list-style-type: none"> • Treatment is provided on an outpatient basis in accordance with results of the consultation (mild to moderate deficiency, no inhibitors). • Local measures (e.g., splints, thrombin, microfibrillar collagen) are used for control of bleeding (see Table 2.5.6). • Aspirin, other NSAIDs, and aspirin-containing compounds should be avoided. 	

Continued

POTENTIAL MEDICAL PROBLEM
RELATED TO DENTAL CARE

ORAL MANIFESTATIONS

PREVENTION OF PROBLEMS

TREATMENT PLANNING MODIFICATION(S)

von Willebrand Disease
Chapter 25

- | | | |
|--|--|--|
| <p>1. Excessive bleeding after invasive dental procedures</p> <ul style="list-style-type: none"> • Spontaneous bleeding • Prolonged bleeding after dental procedures that injure soft tissue or bone • Petechiae • Hematomas | <ul style="list-style-type: none"> • Identification of patients should include: <ul style="list-style-type: none"> • History of bleeding problems in relatives and of excessive bleeding after surgery or trauma and so on. • Examination findings to include: <ol style="list-style-type: none"> 1. Petechiae 2. Hematomas • Screening laboratory tests—possible prolonged partial thromboplastin time, platelet count may be low. • Consultation and referral should be provided for diagnosis and treatment and preparation before dental procedures. • Type I and many type II cases require the following: <ul style="list-style-type: none"> • 1-Desamino-8-D-arginine vasopressin (desmopressin and Amicar) • Local measures (see Table 25.6) • May be treated on an outpatient basis • Type III and some type II patients require the following: <ul style="list-style-type: none"> • Fresh-frozen plasma • Cryoprecipitate • Special factor VIII concentrates (retain vWF) <ol style="list-style-type: none"> 1. Humate-P 2. Koate HS • Local measures (see Table 25.6) • Outpatient treatment is possible on the basis of results of consultation. • Avoid aspirin, other NSAIDs, and aspirin-containing compounds. | <ul style="list-style-type: none"> • No invasive dental procedures should be performed unless the patient has been prepared on the basis of consultation with a hematologist. • Most dental procedures, including complex restorations, can be offered to these patients. • Emphasis is on maintaining good oral hygiene, topical fluorides, and diet. • Acetaminophen with or without codeine may be used for postoperative pain control. |
|--|--|--|

POTENTIAL MEDICAL PROBLEM RELATED TO DENTAL CARE	ORAL MANIFESTATIONS	PREVENTION OF PROBLEMS	TREATMENT PLANNING MODIFICATION(S)
<p>Anxiety Chapter 28</p> <ol style="list-style-type: none"> 1. Extreme apprehension 2. Avoidance of dental care 3. Elevation of blood pressure 4. Precipitation of arrhythmia 5. Adverse effects and drug interactions with agents used in dentistry 	<ul style="list-style-type: none"> • Usually none • Oral lesions associated with adverse effects of medications 	<ul style="list-style-type: none"> • Behavioral aspects—the dentist should do the following: <ul style="list-style-type: none"> • Provide effective communication (be open and honest). • Explain what is going to happen. • Make procedures as “pain free” as possible. • Encourage patient to ask questions at any time. • Use relaxation techniques such as hypnosis, music, and others. • Pharmacologic aspects—the dentist should provide the following as indicated: <ul style="list-style-type: none"> • Oral sedation—alprazolam, diazepam, triazolam • Inhalation sedation—nitrous oxide • Intramuscular sedation—midazolam, meperidine • Intravenous sedation—diazepam, midazolam, fentanyl • Analgesics for pain control—salicylates or NSAIDs, acetaminophen, codeine, oxycodone, fentanyl • Adjunctive medications—antidepressants, muscle relaxants, steroids, anticonvulsants, antibiotics 	<ul style="list-style-type: none"> • Postpone complex dental procedures until patient is more comfortable in the dental environment. • It is important to develop trust and establish communication with patients with posttraumatic stress disorder. • May need to refer for diagnosis and treatment patients with panic attack or phobic symptoms related to dentistry.

Continued

POTENTIAL MEDICAL PROBLEM RELATED TO DENTAL CARE	ORAL MANIFESTATIONS	PREVENTION OF PROBLEMS	TREATMENT PLANNING MODIFICATION(S)
Eating Disorders: Anorexia Nervosa and Bulimia Nervosa <i>Chapter 28</i>			
<ol style="list-style-type: none"> 1. Patients with anorexia are in a state of self-starvation (severe weight loss) and may be subject to hypotension, bradycardia, severe arrhythmia, and death. 2. Patients with bulimia are at risk for serum electrolyte disturbances, esophageal or gastric rupture, cardiac arrhythmia, and death. 3. Patients with bulimia may induce vomiting through the use of physical means (finger in throat) or the use of ipecac (may cause myopathy or cardiomyopathy); laxatives and diuretics also are used by bulimics to purge. 4. Some patients may show signs and symptoms of both anorexia and bulimia. 	<ul style="list-style-type: none"> • With bulimia, the following may be noted: <ul style="list-style-type: none"> • Dental erosion of the lingual surfaces of teeth (usually maxillary teeth) • Patients with poor oral hygiene may be at increased risk for caries and periodontal disease. • Extensive dental caries (associated with diet—lots of carbohydrates) • Tooth sensitivity to thermal changes • With anorexia, the following may be noted: <ul style="list-style-type: none"> • Intraoral findings are infrequent without concurrent bulimia. • Sialadenosis • If oral hygiene is poor, there is increased risk for caries and periodontal disease. 	<ul style="list-style-type: none"> • Patients with severe weight loss and no history of cancer or other illnesses and who are hypotensive should be referred for medical evaluation and management. • Attempts should be made to ascertain the cause of dental erosion involving the lingual surfaces of teeth. Consider referral for medical and psychosocial evaluation. • Educate the patient as to the serious nature of the complications of anorexia (hypotension, severe arrhythmia, and death) and of bulimia (gastric and esophageal tears, cardiac arrhythmia, and death). 	<ul style="list-style-type: none"> • Avoid elective dental procedures until the patient is stable from a cardiac standpoint. • In general, for patients with bulimia or anorexia, the emphasis should be on oral hygiene maintenance and noncomplex repair until significant improvement in medical health status has been obtained. • Complex restorative procedures should be avoided in patients with bulimia until the purging has been controlled. However, crowns may help stabilize a tooth or help protect it from thermal symptoms in patients who are still actively purging.
Anxiolytic Drugs (for Anxiety Control): Benzodiazepines—Chlordiazepoxide (Librium), Diazepam (Valium), Lorazepam (Ativan), Oxazepam (Serax), Alprazolam (Xanax) <i>Chapter 28</i>			
<ol style="list-style-type: none"> 1. Drug adverse effects include the following: <ol style="list-style-type: none"> a. Daytime sedation b. Aggressive behavior c. Amnesia (older adults) 2. Drug interactions (central nervous system [CNS] depression): <ol style="list-style-type: none"> a. Antipsychotic agents b. Antidepressants c. Narcotics d. Sedative agents e. Antihistamines f. Histamine H₂ receptor blockers 	<ul style="list-style-type: none"> • Usually no significant oral findings 	<ul style="list-style-type: none"> • Advise patient not to drive when using these medications. • Use reduced dosage in older adults. • Limit reduce dosage for patients taking other CNS depressant drugs. • Use reduced dosage in: <ul style="list-style-type: none"> • Older adults • Patients taking cimetidine • Patients taking ranitidine • Patient taking erythromycin • Do not dispense to patients with narrow-angle glaucoma. 	<ul style="list-style-type: none"> • When using sedative agents, narcotics, or antihistamines, reduce dosage or do not use these agents. • All dental procedures can be provided to patients taking these medications. • Use anxiolytic drugs in dentistry for short durations to avoid tolerance and dependency.

POTENTIAL MEDICAL PROBLEM RELATED TO DENTAL CARE	ORAL MANIFESTATIONS	PREVENTION OF PROBLEMS	TREATMENT PLANNING MODIFICATION(S)
<p>Depression and Bipolar Disorders Chapter 29</p> <ol style="list-style-type: none"> Little or no interest in oral health Factors increasing risk of suicide: <ol style="list-style-type: none"> Age—adolescents and older adults at greatest risk Chronic illness, alcoholism, drug abuse, and depression Recent diagnosis of serious condition such as AIDS and cancer Previous suicide attempts Recent psychiatric hospitalization Loss of a loved one Living alone or little social contact Taking medications that have significant adverse effects and that may interact with agents used by the dentist 	<ul style="list-style-type: none"> Depression—poor oral hygiene and xerostomia associated with agents used to treat depression increase risks for caries and periodontal disease; facial pain syndromes and glossodynia Manic disorder—injury to soft tissue and abrasion of teeth from overflossing and overbrushing Oral lesions associated with the adverse effects of medications used to treat depression and mania 	<ul style="list-style-type: none"> If patient appears very depressed: <ul style="list-style-type: none"> Ask about thoughts of suicide: <ol style="list-style-type: none"> Does patient have a plan? Does patient have the means to carry out the plan? Immediately refer patient who is suicidal for medical intervention. If possible, involve family member or relative. Obtain good history, including medications (prescription, herbal, over the counter), and avoid using agents that may have significant interactions (see Table 29.7). If history and examination findings suggest presence of significant drug adverse effects, refer patients to a physician. 	<ul style="list-style-type: none"> Patients often have little interest in dental health or home care procedures, and poor dental repair is common. Emphasis should be on maintaining the best possible oral health during depressive episodes. Dental treatment should be directed toward immediate needs with elective and complex procedures delayed until effective medical management of depression and mania is obtained.
<p>Schizophrenia Chapter 29</p> <ol style="list-style-type: none"> Patient may be difficult to communicate with and uncooperative during dental care. Significant drug adverse effects are common, and agents used by the dentist may interact with medications the patient is taking (see later section on antipsychotic [neuroleptic] drugs). 	<ul style="list-style-type: none"> Usually none Oral lesions may be self-inflicted or may develop as adverse effects of medications used to treat the patient (see later section on antipsychotic drugs). 	<ul style="list-style-type: none"> Have family member or attendant accompany the patient. Schedule morning appointments. Avoid confrontational and authoritative attitudes. Perform elective dental care only if patient is under good medical management. Consider sedation with diazepam or oxazepam. 	<ul style="list-style-type: none"> Emphasis is on maintaining oral health and comfort by preventing and controlling dental disease. Family member or attendant may have to assist patient with home care procedures. Complex dental procedures usually are not indicated.

Continued

POTENTIAL MEDICAL PROBLEM RELATED TO DENTAL CARE

ORAL MANIFESTATIONS

PREVENTION OF PROBLEMS

TREATMENT PLANNING MODIFICATION(S)

Antidepressant Drugs

Chapter 29

1. Drug adverse effects include the following:
 - a. Xerostomia
 - b. Hypotension
 - c. Orthostatic hypotension
 - d. Arrhythmia
 - e. Nausea and vomiting
 - f. Leukopenia, anemia, thrombocytopenia, agranulocytosis
 - g. Mania, seizures
 - h. Hypertension (venlafaxine)
 - i. Loss of libido
 2. Drug interactions include the following:
 - a. Epinephrine
 - Hypertensive crisis
 - MI
 - b. Sedative, hypnotics, narcotics, and barbiturates may cause respiratory depression.
 - c. Atropine: Increase intraocular pressure.
 - d. Warfarin metabolism may be inhibited, thus causing bleeding.
 3. Patients taking monoamine oxidase (MAO) inhibitors must avoid foods that contain tyramine (may cause severe hypertension).
- | | | |
|--|---|--|
| <ul style="list-style-type: none"> • Oral findings not typically associated with medications, unless the following drug adverse effects are present: <ul style="list-style-type: none"> • Xerostomia—increases risk for caries, periodontal disease, and mucositis • Leukopenia—infection • Thrombocytopenia—bleeding | <ul style="list-style-type: none"> • Identify by medical and drug history patients who are taking any of these medications. • Identify patients with significant drug adverse effects: <ul style="list-style-type: none"> • History • Examination—blood pressure, pulse rate, bleeding, soft tissue lesions, infection • Refer patients with significant drug adverse effects. • Consult with patient's physician to confirm current status and medications. • Minimize effects of orthostatic hypotension: <ul style="list-style-type: none"> • Change chair position slowly. • Support patients as they get out of the dental chair. • Avoid atropine in patients with glaucoma. • Use epinephrine with caution and only in small concentrations. • Look up specific medication the patient is taking to explore significant adverse effects associated with the drug and possible drug interactions with agents used in dentistry. • Do not mix the different classes of antidepressant drugs | <ul style="list-style-type: none"> • Avoid elective dental procedures until depression has been managed by medication or behavioral means. • Local anesthetic: <ul style="list-style-type: none"> • Use without vasoconstrictor for most dental procedures. • For surgical or complex restorative procedures: <ol style="list-style-type: none"> 1. Epinephrine is the vasoconstrictor of choice. 2. Use 1:100,000 concentration of epinephrine. 3. Aspirate before injecting. 4. In general, do not use more than 2 cartridges. • Do not use topical epinephrine to control bleeding or in retraction cord. • Provide treatment to deal with xerostomia (see Appendix C). |
|--|---|--|

POTENTIAL MEDICAL PROBLEM RELATED TO DENTAL CARE	ORAL MANIFESTATIONS	PREVENTION OF PROBLEMS	TREATMENT PLANNING MODIFICATION(S)
Antimanic (Mood-Stabilizing) Drugs <i>Chapter 29</i>			
1. Lithium	<ul style="list-style-type: none"> Lithium (metallic taste) Valproic acid and carbamazepine Oral ulcerations Bleeding Infection Tremor of the tongue 	<ul style="list-style-type: none"> Identify by medical and drug histories that patients are taking these medications. Refer to physician when significant drug adverse effects occur. Avoid the use of NSAIDs and erythromycin or use at reduced dosage in patients on lithium. Avoid the use of erythromycin or use in reduced dosage in patients who are taking valproic acid or carbamazepine. Patients taking lamotrigine who complain of tingling and itching of the skin should be referred to their physicians for possible change in medication; such symptoms may be the first sign of Stevens-Johnson syndrome developing. 	<ul style="list-style-type: none"> No special modifications are needed in the treatment plans of patients whose condition is well controlled with lithium or anticonvulsant drugs. Patients with signs or symptoms of lithium toxicity should be referred to their physicians for evaluation. NSAIDs should be avoided or used at reduced dosage for pain control in patients who are taking lithium, to prevent lithium toxicity. The NSAIDs should also be avoided in patients who are taking valproic acid or carbamazepine. Patients taking the anticonvulsant drugs (valproic acid or carbamazepine) who develop oral ulcerations, infection, or bleeding should be referred for medical evaluation.
2. Valproic acid, carbamazepine, and lamotrigine	<ul style="list-style-type: none"> Xerostomia Hypothyroidism Diabetes insipidus Arrhythmia Sedation Seizures 	<ul style="list-style-type: none"> NSAIDs Diuretics Erythromycin 	
a. Adverse effects include the following:	<ul style="list-style-type: none"> Nausea, vomiting, diarrhea Metallic taste Xerostomia Hypothyroidism Diabetes insipidus Arrhythmia Sedation Seizures 		
b. Drug interactions (toxicity) include the following:	<ul style="list-style-type: none"> NSAIDs Diuretics Erythromycin 		
a. Adverse effects include the following:	<ul style="list-style-type: none"> Nausea, ataxia, blurred vision Tremor Xerostomia Agranulocytosis (infection) Platelet dysfunction (bleeding) Seizures, if abruptly stopped Stevens-Johnson syndrome Rare suicide ideation 		
b. Drug interactions (toxicity) include the following:	<ul style="list-style-type: none"> Erythromycin Isoniazid Cimetidine 		

Continued

POTENTIAL MEDICAL PROBLEM RELATED TO DENTAL CARE

TREATMENT PLANNING MODIFICATION(S)

PREVENTION OF PROBLEMS

ORAL MANIFESTATIONS

Antipsychotic (Neuroleptic) Drugs Chapter 29

- | | | |
|--|--|---|
| <p>1. Drug adverse effects include the following:</p> <ol style="list-style-type: none"> Hypotension Acute dystonia, akathisia Parkinsonism Tardive dyskinesia Xerostomia, dry eyes Dizziness, postural hypotension Sexual dysfunction Seizures Neuroleptic malignant syndrome Agranulocytosis <p>2. Drug interactions include the following:</p> <ol style="list-style-type: none"> Prolong or intensify the actions of the following: <ul style="list-style-type: none"> Alcohol Sedatives, hypnotics, opioids, antihistamines Anesthetics (general) Antiarrhythmics—<i>increase risk of arrhythmia</i> Anticonvulsants—<i>reduce effects of neuroleptic drugs</i> Antihypertensives—<i>increase risk of hypotension</i> Erythromycin—<i>increase serum level of neuroleptic drugs</i> Sympathomimetics (epinephrine)—<i>a rare risk for hypotension with dosages used in dentistry.</i> | <p>No significant oral findings are associated with these medications, unless the following drug adverse effects are present:</p> <ul style="list-style-type: none"> Agranulocytosis—ulceration, infection Xerostomia—mucositis, caries, periodontal disease Leukopenia—infection Thrombocytopenia—bleeding Tardive dyskinesia—uncontrolled movement of the lips and tongue <p>Identification of patients:</p> <ul style="list-style-type: none"> Obtain history of mental disorder (patient may be taking antipsychotic medication). Ask patients to list all drugs that they are taking. Identify patients with recent onset of adverse effects. Refer patients with significant adverse effects. Obtain consultation with patient's physician to confirm current status and medications. Reduce dosage or avoid: <ul style="list-style-type: none"> Epinephrine Sedatives, hypnotics, opioids, antihistamines Erythromycin | <p>Local anesthetic guidelines include the following:</p> <ul style="list-style-type: none"> Use without vasoconstrictor for most dental procedures, if possible. For surgical or complex restorative procedures, epinephrine is the vasoconstrictor of choice: <ol style="list-style-type: none"> Use 1:100,000 concentration. Aspirate before injecting. In general, limit to two or fewer cartridges. Do not use topical epinephrine to control bleeding or in the retraction cord. On the basis of patient needs and wants, any dental procedure can be provided. Provide treatment to deal with xerostomia, if present (see Appendix C). Patients with tardive dyskinesia may be difficult to manage; if this adverse effect has just started, refer patients to their physician for evaluation and possible change in medication. |
|--|--|---|

POTENTIAL MEDICAL PROBLEM RELATED TO DENTAL CARE	ORAL MANIFESTATIONS	PREVENTION OF PROBLEMS	TREATMENT PLANNING MODIFICATION(S)
Somatiform Disorders—Conversion Disorder, Pain Disorder, Factitious Disorder, Others <i>Chapter 29</i>			
1. Somatoform disorders: a. Isolated symptoms with no physical cause that do not conform to known anatomic pathways b. Psychological factors involved in the origin c. May serve as a defense to reduce anxiety (primary gain) d. Secondary gain reason for not working, attention from family e. When these patients are followed over time, in 10% to 50%, a physical disease process will become apparent.	<ul style="list-style-type: none"> • Examples of oral symptoms that can be related to somatoform disorders: <ul style="list-style-type: none"> • Burning tongue • Painful tongue • Numbness of soft tissues • Tingling sensations in oral tissues • Pain in the facial region • Oral examples of factitious injuries: <ul style="list-style-type: none"> • Self-extraction of teeth • Picking gingiva with fingernails • Nail file gingival injury • Chemical burning of the lips and oral mucosa • Thermal burning of lips and oral mucosa 	<ul style="list-style-type: none"> • Refer patients found to have psychological disorders for diagnosis and management but stay involved from a dental standpoint. • Discuss with patient the possible causes of symptoms, and rule out underlying systemic conditions that could account for the symptoms. • Continue to examine for signs and symptoms that may be related to an underlying systemic or local condition. 	<ul style="list-style-type: none"> • Do not perform dental treatment on the basis of the patient's symptoms unless a dental cause can be established. • A diagnosis of an oral somatoform disorder should not be made until after a thorough search over time has failed to uncover pathologic findings that could explain the symptoms. • Maintain good oral hygiene and dental repair for the patient but avoid complex dental procedures until somatoform symptoms have been managed. • Patients may insist that the dentist “do something” to relieve the symptom, such as extraction or endodontic therapy; the dentist must avoid such nonindicated interventions. • Antidepressants and pain medication may be used to comfort the patient.
2. Factitious disorders: a. Intentional production of physical or psychological signs b. Voluntary production of symptoms without external incentive c. More often seen in men and health care workers			

Continued

POTENTIAL MEDICAL PROBLEM RELATED TO DENTAL CARE

Drug and Alcohol Abuse Chapter 30

POTENTIAL MEDICAL PROBLEM RELATED TO DENTAL CARE	ORAL MANIFESTATIONS	PREVENTION OF PROBLEMS	TREATMENT PLANNING MODIFICATION(S)
<ol style="list-style-type: none"> 1. Drug abusers may try to obtain controlled substances from the dentist by fraudulent claims or behavior. 2. Patients may be undiagnosed alcohol or drug abusers. 3. Methamphetamine and cocaine abusers are at risk for acute hypertension if epinephrine is administered. 4. Patients with alcohol abuse may have excessive bleeding, unpredictable drug metabolism, and risk for infection due to liver disease. 5. Dilated pupils, elevated blood pressure, or cardiac arrhythmias may indicate recent drug use and increase risk for stroke, arrhythmias, and MI. 	<ul style="list-style-type: none"> • Drug or alcohol abusers may have excessive caries and periodontal disease from oral neglect; amphetamine abuse often leads to extensive caries (“meth mouth”). • Alcohol abuse and associated altered drug metabolism by liver can alter anesthesia effectiveness. • Alcohol abuse is a risk factor for oral cancer, especially when coupled with tobacco use. • Drug and alcohol abuse may lead to xerostomia. • Alcohol abuse may lead to petechiae, ecchymosis, and parotid enlargement. 	<ul style="list-style-type: none"> • Be alert for signs or symptoms suggestive of substance abuse. • Discuss concerns with the patient, refer to physician for further evaluation, and recommend rehabilitation counseling services. • If significant alcohol abuse is present, consider ordering liver function tests before surgical procedures. • For suspected substance abusers, avoid prescribing controlled medications or, if needed, prescribe only a limited amount with no refills. • For recovering substance abusers, avoid prescribing controlled medications, if possible. • For suspected methamphetamine or cocaine users, avoid the use of epinephrine. 	<ul style="list-style-type: none"> • If patient has a history or clinical findings consistent with active drug or alcohol abuse, elective dental care should be deferred, and the patient should be encouraged to seek medical care. • If oral neglect is evident, patient should be required to demonstrate interest in and ability to care for dentition before any significant dental treatment is undertaken. • Oral infections should be treated aggressively if patient is immune suppressed because of alcoholic liver disease. • For opioid overdose, use Naloxone (Norean Nasal Spray); it will reverse the effects of opioid over dose.

Patient Evaluation and Risk Assessment

Patient Evaluation and Risk Assessment

The practice of dentistry continues to evolve, not only in techniques and procedures but also in the types of patients encountered. As a result of advances in medical science, people are living longer and are receiving medical treatment for disorders that were fatal only a few years ago. For example, damaged heart valves are surgically replaced, occluded coronary arteries are surgically bypassed or opened by balloons and stents, organs and bone marrow are transplanted, severe hypertension is medically controlled, and many types of malignancies and immune deficiencies are managed or controlled.

Because of the increasing numbers of dental patients, especially among older adults who have chronic medical problems, dentists must remain knowledgeable about a wide range of medical conditions and drug considerations. Many chronic disorders or their treatments necessitate alterations in the provision of dental treatment. Failure to make appropriate treatment modifications may have serious clinical consequences.

The key to successful dental management of a medically compromised patient is a thorough evaluation of the patient followed by a thoughtful assessment of risk to determine whether a planned procedure can be safely tolerated. The fundamental question that must be addressed is whether the benefit of dental treatment outweighs the risk of a medical complication occurring either during treatment or as a result of treatment. This evaluation begins with a thorough review of the medical history, expanded as necessary by discussion of any relevant issues with the patient, and proceeds to identification of drugs or medications that the patient is taking (or is supposed to be taking), examining the patient for symptoms and signs of disease as well as obtaining vital signs, reviewing current imaging and laboratory test results, and obtaining a medical consultation if needed. All of this information can then be applied to assess the risk for problems related to specific factors identified in the evaluation. This process benefits from the use of a checklist as summarized in [Box 1.1](#), which illustrates an “ABC”-type format.

MEDICAL HISTORY

A medical history must be taken for every patient who is to receive dental treatment. Two basic techniques are used to obtain a medical history. The first technique consists of an interview of the patient (medical model),

in which the interviewer questions the patient and then records a narrative of the patient’s verbal responses on a blank sheet. The second technique is the use of a questionnaire that the patient fills out. The latter approach is most commonly used in dental practice and is very convenient and efficient. It is important, however, that the medical information acquired in this manner be reviewed by the dentist and discussed or clarified with the patient as appropriate to determine the significance of the findings and any necessary modifications in dental treatment.

Many questionnaires are commercially available in both electronic and hard copy versions. Dentists also may develop or modify questionnaires to meet the specific needs of their individual practices. Although medical history questionnaires may differ in organization and detail, most attempt to elicit information about the same basic medical problems. The following section presents an overview of such medical conditions, organized by body systems, as well as other conditions and factors of relevance, and specifies the rationale for why certain questions are asked and highlights the significance of positive responses on the questionnaire or in the interview. Detailed information concerning most of these medical problems is found in the specific subsequent chapters.

Cardiovascular Disease

Patients with various forms of cardiovascular disease are especially vulnerable to physical or emotional challenges that may be encountered during dental treatment.

Heart Failure. Heart failure is not a disease per se but rather a clinical syndrome complex that results from an underlying cardiovascular problem such as coronary heart disease or hypertension. The underlying cause of the heart failure should be identified and its potential significance assessed. Patients with untreated or symptomatic heart failure are at increased risk for myocardial infarction (MI), arrhythmias, acute heart failure, or sudden death and generally are not candidates for elective dental treatment. Chair position may influence the ability to breathe, with some patients unable to tolerate a supine position. Vasoconstrictors should be avoided in certain circumstances, for example, if a patient has severe heart failure and in patients who take digitalis glycosides (digoxin) because the combination can precipitate arrhythmias (see

BOX 1.1 Dental Management Summary of Patient Evaluation and Risk Assessment**A****Awareness**

- Be **aware** of adverse outcomes that may occur in the management of a patient who has a medical condition.

P**Patient Evaluation and Risk Assessment**

- Review **medical history** and engage in direct discussion of relevant issues with the patient.
- Identify all **medications and drugs** being taken or supposed to be taken by the patient.
- **Examine** the patient for signs and symptoms of disease and obtain vital signs.
- Review or obtain recent **laboratory test** results or **images** required to assess risk.
- Obtain a **medical consultation** if the patient has a poorly controlled or undiagnosed problem or if the patient's health status is uncertain.

Potential Issues and Questions of Concern**A**

Antibiotics	Will the patient need antibiotics, either prophylactically or therapeutically? Is the patient currently taking an antibiotic? Is the patient at risk for infection?
Analgesics	Is the patient taking aspirin or other NSAIDs that may increase bleeding? Will analgesics be needed after the procedure?
Anesthesia	Are there any potential problems or concerns associated with the use or dosage of local anesthetic or with vasoconstrictors?
Anxiety	Will the patient need a sedative or anxiolytic?

B

Bleeding	Is abnormal hemostasis a possibility? Is the patient taking medications that can affect bleeding during or after an invasive procedure?
Breathing	Does the patient have any difficulty breathing, or is the breathing abnormally fast or slow?
Blood pressure	Is the blood pressure well controlled, or is it likely to increase or decrease during dental treatment?

C

Capacity to tolerate care	Does the patient have sufficient functional (cardiovascular) and emotional capacity to withstand the type of dental procedure planned?
Chair position	Can the patient tolerate a supine chair position, or is the patient likely to experience difficulty with rapid position changes?

D

Drugs	Are any drugs being taken by the patient or to be administered or prescribed by the dentist associated with relevant drug interactions, adverse effects, or allergies?
Devices	Does the patient have prosthetic or therapeutic devices that may require specific considerations in management (e.g., prosthetic heart valve, prosthetic joint, stent, pacemaker, defibrillator, arteriovenous fistula)?

E

Equipment	Are there any potential problems associated with the use of dental equipment (e.g., x-ray machine, electrocautery, oxygen supply, ultrasonic cleaner)? Are monitoring devices such as a pulse oximeter, carbon dioxide monitor, or blood pressure measurement device indicated for use during the dental procedure?
Emergencies	Are there any medical urgencies or emergencies that might be anticipated or prevented by modifying care?

F

Follow-up	Is any follow-up care indicated? Should the patient be contacted at home to assess her or his response to treatment?
-----------	--

NSAID, Nonsteroidal antiinflammatory drug.

Chapter 6). Stress reduction measures also may be advisable (Box 1.2).

Heart Attack. A history of a heart attack (MI) within the very recent past may preclude elective dental care because during the immediate postinfarction period, patients are at increased risk for reinfarctions, arrhythmias, and heart failure. Patients may be taking medications such as antianginals, anticoagulants, adrenergic blocking agents, calcium channel blockers, antiarrhythmic agents, or digitalis. Some of these drugs may alter the dental management of patients because of potential interactions

BOX 1.2 General Stress Reduction Protocol

- Open communication about fears or concerns
- Short appointments (preferably morning)
- Preoperative sedation: short-acting benzodiazepine (e.g., triazolam 0.125–0.25 mg) 1 hour before the appointment and possibly the night before the day of the appointment
- Intraoperative sedation (N₂O-O₂)
- Profound local anesthesia: use topical before injection
- Adequate operative and postoperative pain control
- Patient contacted on evening of the procedure

with vasoconstrictors in local anesthetic, adverse side effects, or other considerations (see [Chapter 4](#)). Stress and anxiety reduction measures may be advisable (see [Box 1.2](#)).

Angina Pectoris. Brief substernal pain resulting from myocardial ischemia, commonly provoked by physical activity or emotional stress, is a common and significant symptom of coronary heart disease. Patients with angina, especially unstable or severe angina, are at increased risk for arrhythmias, MI, and sudden death. A variety of vasoactive medications, such as nitroglycerin, β -adrenergic blocking agents, and calcium channel blockers, are used to treat angina. Caution is advised with the use of vasoconstrictors. Stress and anxiety reduction measures may be appropriate (see [Box 1.2](#)). Patients with unstable or progressive angina are not candidates for elective dental care (see [Chapter 4](#)).

High Blood Pressure. Patients with hypertension (blood pressure $>140/90$ mm Hg) should be identified by history and the diagnosis confirmed by blood pressure measurement. Patients with a history of hypertension should be asked if they are taking or are supposed to be taking antihypertensive medication. Failure to take medication often is the cause of elevated blood pressure in a patient who reports being under treatment for hypertension. Current blood pressure readings and any clinical signs and symptoms that may be associated with severe, uncontrolled hypertension, such as visual changes, dizziness, spontaneous nosebleeds, and headaches, should be noted. Some antihypertensive medications, such as the nonselective β -adrenergic blocking agents, may require caution in the use of vasoconstrictors (see [Chapter 3](#)). The coadministration of calcium channel blockers with macrolide antibiotics (e.g., erythromycin, clarithromycin) can result in excessive hypotension. Stress and anxiety reduction measures also may be appropriate (see [Box 1.2](#)). Elective dental care should be deferred for patients with severe, uncontrolled hypertension (blood pressure of $\geq 180/110$ mm Hg) until the condition can be brought under control because they have an increased risk of stroke.

Heart Murmur. A heart murmur is caused by turbulence of blood flow that produces vibratory sounds during the beating of the heart. Turbulence may result from physiologic (normal) factors or pathologic abnormalities of the heart valves, vessels, or both. The presence of a heart murmur may be of significance in dental patients because it may be an indication of underlying heart disease. The primary goal is to determine the nature of the heart murmur; consultation with the patient's physician often is necessary to make this determination. Previously, the American Heart Association (AHA) recommended antibiotic prophylaxis for many patients with heart murmurs caused by valvular disease (e.g., mitral valve prolapse, rheumatic heart disease) in an effort to prevent infective endocarditis; however, current guidelines omit this recommendation on the basis of accumulated scientific evidence.

If a murmur is caused by certain specific cardiac conditions (e.g., previous endocarditis, prosthetic heart valve, complex congenital cyanotic heart disease), the AHA continues to recommend antibiotic prophylaxis for most dental procedures (see [Chapter 2](#)).

Mitral Valve Prolapse. In mitral valve prolapse (MVP), the leaflets of the mitral valve “prolapse,” or balloon back into, the left atrium during systole. As a result, tight closure of the leaflets may not occur, which can result in leakage or backflow of blood (regurgitation) from the ventricle into the atrium. Not all patients with MVP have regurgitation, however. In past guidelines, the AHA recommended that patients with MVP with regurgitation receive antibiotic prophylaxis for invasive dental procedures to prevent infective endocarditis. However, on the basis of accumulated scientific evidence, current guidelines do not include this recommendation (see [Chapter 2](#)).

Rheumatic Fever. Rheumatic fever is an autoimmune condition that can follow an upper respiratory β -hemolytic streptococcal infection and may lead to damage of the heart valves (rheumatic heart disease). The AHA currently does not recommend antibiotic prophylaxis for patients with a history of this condition (see [Chapter 2](#)).

Congenital Heart Disease. Patients with some forms of severe congenital heart disease are at increased risk for infective endocarditis, an infection which can result in significant morbidity and mortality. These are primarily patients with complex cyanotic heart disease (e.g., tetralogy of Fallot) and those who have had an incomplete surgical repair of a congenital defect, with a residual leak. The AHA recommends that these patients receive antibiotic prophylaxis for most dental procedures. For patients with most other types of congenital heart disease, the AHA currently does not recommend antibiotic prophylaxis (see [Chapter 2](#)).

Artificial Heart Valve. A diseased valve may be replaced with artificial or prosthetic valves. Such replacement valves are associated with a high risk for development of infective endocarditis, with significant morbidity and mortality. Accordingly, the AHA recommends that all patients with a prosthetic heart valve be given prophylactic antibiotics before most dental procedures (see [Chapter 2](#)). Patients with an artificial heart valve also may be on anticoagulant medication to prevent blood clots associated with the valve. In such patients, excessive bleeding may be encountered with surgical procedures. It is therefore necessary to determine the level of anticoagulation before any invasive procedure.

Arrhythmias. Arrhythmias frequently are related to heart failure or ischemic heart disease. Stress, anxiety, physical activity, drugs, and hypoxia are some elements that can precipitate arrhythmias. Vasoconstrictors in local anesthetics should be used cautiously in patients prone to arrhythmias because they may be precipitated by excessive quantities or inadvertent intravascular injections. Stress reduction measures may be appropriate (see [Box 1.2](#)). Some of these patients take antiarrhythmic drugs,

which can cause orthostatic hypotension and adversely interact with vasoconstrictors. Antiarrhythmic drugs can also cause adverse oral health changes. Patients with atrial fibrillation also may be taking anticoagulant or antiplatelet medications, which is associated with increased risk for excessive bleeding with surgical procedures. Patients with certain arrhythmias may require a pacemaker or a defibrillator to regulate or pace heart rhythm by artificial means. Patients with such devices do not require antibiotic prophylaxis. Caution is advised with the use of certain types of electrical equipment (e.g., electrocautery) in patients with pacemakers or defibrillators because of the possibility of intermittent electromagnetic interference with the function of these devices (see [Chapter 5](#)). Elective dental care is not recommended for patients with severe, symptomatic arrhythmias.

Coronary Artery Bypass Graft, Angioplasty, or Stent.

These procedures are performed in patients with coronary heart disease to restore patency to blocked coronary arteries. One of the more common forms of cardiac surgery performed today is coronary artery bypass grafting (CABG). The grafted artery bypasses the occluded portion of the artery. These patients do not require antibiotic prophylaxis. Another method of restoring patency is by means of a balloon catheter, which is inserted into the partially blocked artery; the balloon is then inflated, which compresses the atheromatous plaque against the vessel wall. A metallic mesh stent then may be placed to aid in the maintenance of patency. After stent placement, patients often are prescribed one or more antiplatelet drugs to decrease the risk of blood clots associated with the stents and may therefore be at increased risk for excessive bleeding with surgical procedures. Patients who have had balloon angioplasty with or without placement of a stent do not require antibiotic prophylaxis (see [Chapter 4](#)).

Hematologic Disorders

Hemophilia or Inherited Bleeding Disorder. Patients with an inherited bleeding disorder such as hemophilia A or B, or von Willebrand disease, are at risk for severe bleeding after any type of dental treatment that causes bleeding, including scaling and root planing. These patients must be identified and managed in cooperation with a physician or hematologist. Patients with severe factor deficiency may require factor replacement before invasive treatment, as well as aggressive postoperative measures to maintain hemostasis (see [Chapter 25](#)).

Blood Transfusion

Patients with a history of blood transfusions are of concern from at least two aspects. The underlying problem that necessitated a blood transfusion, such as an inherited or acquired bleeding disorder, must be identified, and alterations in the delivery of dental treatment may have to be made. These patients also may be carriers of hepatitis B or C or may have become infected with the human immunodeficiency virus (HIV) and must be identified.

Laboratory screening or medical consultation may be appropriate to determine the white blood cell count or status of liver function, and, as always, standard infection control procedures are mandatory (see [Chapters 10, 18, and 24](#)).

Anemia

Anemia is associated with a significant reduction in the number of red blood cells or oxygen-carrying capacity of the red blood cells. This condition may result from an underlying pathologic process such as acute or chronic blood loss, decreased production of red blood cells, or hemolysis. Patients with some forms of anemias, such as glucose-6-phosphate dehydrogenase (G6PD) deficiency and sickle cell disease, require dental management modifications. Oral lesions, infections, delayed wound healing, and adverse responses to hypoxia all are potential matters of concern in patients who have anemia (see [Chapter 22](#)).

Leukemia and Lymphoma

Depending on the type of leukemia or lymphoma, status of the disease, white blood cell count, and type of treatment, some patients may have bleeding problems or delayed healing or may be prone to infection. Gingival enlargement and gingival bleeding can be a sign of leukemia. Adverse effects can result from the use of chemotherapeutic agents and may require dental management modifications (see [Chapter 23](#)).

Taking a “Blood Thinner” or the Tendency to Bleed Longer Than Normal

A potentially significant problem occurs when a patient has a history of abnormal bleeding or is taking an anticoagulant or an antiplatelet drug. This is of obvious concern, especially if surgical treatment is planned. Information about an episode of unexplained bleeding should be obtained and evaluated. Many reports of abnormal bleeding are more apparent than real; additional questioning or screening laboratory tests may allow the dentist to make this distinction. Patients taking anticoagulant or antiplatelet medication need to be evaluated to determine the risk for postoperative bleeding. Many patients can be treated without alteration of their medication regimens; however, laboratory testing may help to make this determination (see [Chapters 24 and 25](#)).

Neurologic Disorders

Stroke. Disorders that predispose to stroke such as hypertension and diabetes must be identified so that appropriate management alterations can be made. Elective dental care should be avoided in the immediate post-stroke period because of an increased risk for subsequent strokes. Vasoconstrictors should be used cautiously. Anticoagulant medications and antiplatelet medications can cause excessive bleeding. Stress and anxiety reduction measures may be necessary (see [Box 1.2](#)). Some stroke victims may have

residual paralysis, speech impairment, or other physical impairments that require special dental care or oral hygiene assistance. Calcified atheromatous plaques may be seen in the carotid arteries on panoramic films; the presence of such lesions may be a risk factor for stroke and requires referral to a physician (see [Chapter 27](#)).

Epilepsy, Seizures, and Convulsions. A history of epilepsy or grand mal seizures should be identified, and the degree of seizure control should be determined. Specific triggers of seizures (e.g., odors, bright lights) should be identified and avoided. Some medications used to control seizures may affect dental treatment because of drug actions or adverse side effects. For example, gingival overgrowth is a well-recognized adverse effect of diphenylhydantoin (Dilantin). Patients may discontinue the use of anticonvulsant medication without their doctor's knowledge and thus may be susceptible to seizures during dental treatment. Therefore, verification of patients' adherence to their medication schedule is important (see [Chapter 27](#)).

Behavioral Disorders and Psychiatric Treatment. Patients with a history of a behavioral disorder or psychiatric illness as well as the nature of the problem need to be identified. This information may help explain patients' unusual, unexpected, or bizarre behavior or complaints such as unexplainable or unusual conditions. Additionally, some psychiatric drugs have the potential to interact adversely with vasoconstrictors in local anesthetics. Psychiatric drugs also may produce adverse oral effects such as hyposalivation or xerostomia. Other adverse drug effects such as dystonia, akathisia, or tardive dyskinesia may complicate dental treatment. Some patients may be excessively anxious or apprehensive about dental treatment, requiring stress reduction measures (see [Box 1.2](#) and [Chapters 28](#) and [29](#)).

Gastrointestinal Diseases

Stomach or Intestinal Ulcers, Gastritis, and Colitis. Patients with gastric or intestinal disease should not be given drugs that are directly irritating to the gastrointestinal tract, such as aspirin or nonsteroidal antiinflammatory drugs (NSAIDs). Patients with colitis or a history of colitis may not be able to take certain antibiotics. Many antibiotics can cause a particularly severe form of colitis (i.e., pseudomembranous colitis), and older adults are more susceptible to this condition. Some drugs used to treat gastric or duodenal ulcers may cause dry mouth (see [Chapter 11](#)).

Hepatitis, Liver Disease, Jaundice, and Cirrhosis. Patients who have a history of viral hepatitis are of concern in dentistry because they may be asymptomatic carriers of the disease and can transmit it unknowingly to dental personnel or other patients. Of the several types of viral hepatitis, only hepatitis B, C, and D have carrier stages. Fortunately, laboratory tests are available to identify affected patients. Standard infection control measures are mandatory. Patients who have chronic hepatitis (B or C)

may develop cirrhosis, with associated impairment of liver function or liver cancer. Impaired liver function may result in prolonged bleeding and less efficient metabolism of certain drugs, including local anesthetics and analgesics (see [Chapter 10](#)).

Respiratory Tract Disease

Allergies or Hives. Patients may be allergic to some drugs or materials used in dentistry. Common drug allergens include antibiotics and analgesics. Latex allergy also is common, and in patients so affected, alternative materials such as vinyl or powderless gloves and vinyl dam material should be used to prevent an adverse reaction. True allergy to amide local anesthetics is uncommon. Dentists should procure a history regarding allergy by specifically asking patients how they react to a particular substance. This information will help to distinguish a true allergy from intolerance or an adverse side effect that may have been incorrectly identified as an allergy. Symptoms and signs consistent with allergy include itching, urticaria (hives), rash, swelling, wheezing, angioedema, runny nose, and tearing eyes. Isolated signs and symptoms such as nausea, vomiting, heart palpitations, and fainting generally are not of an allergic origin but rather are manifestations of drug intolerance, adverse side effects, or psychogenic reactions (see [Chapter 19](#)).

Asthma. The type of asthma should be identified, as should the drugs taken and any precipitating factors or triggers. Stress may be a precipitating factor and should be minimized when possible (see [Box 1.2](#)). It often is helpful to ask whether the patient has visited the emergency department for acute treatment of asthma because this historical detail would indicate more severe disease. A patient who uses an albuterol inhaler for treatment of acute attacks should be instructed to bring it to his or her dental appointments (see [Chapter 7](#)).

Emphysema and Chronic Bronchitis. Patients with chronic pulmonary diseases such as emphysema and chronic bronchitis must be identified. The use of medications or procedures that might further depress respiratory function or dry or irritate the airway should be avoided. Chair position may be a factor; some patients may not be able to tolerate a supine position. Use of a rubber dam may not be tolerated because of a choking or smothering feeling experienced by the patient. The use of high-flow oxygen should be avoided in patients with severe disease because it can decrease the respiratory drive (see [Chapter 7](#)). Because cigarette smoking is the most common cause of emphysema and chronic bronchitis, the dentist can provide assistance by offering smoking cessation to the interested patient (see [Chapter 8](#)).

Tuberculosis. Patients with a history of tuberculosis (TB) must be identified, and information about the treatment received must be sought. A positive result on skin or blood testing means specifically that the person has at some time been infected with TB, not necessarily that active disease is present. Most patients who have a positive

TB test do not develop active disease. A diagnosis of active TB is made by chest radiography, sputum culture, and clinical examination. Persons who have latent TB, who are at increased risk for the development of active disease, may be placed on chemoprophylaxis (e.g., isoniazid) as a preventive measure. Medical treatment for active disease includes the use of multiple medications taken for several months. A history of follow-up medical evaluation is important to detect reactivation of the disease or inadequate treatment. Patients with acquired immunodeficiency syndrome (AIDS) have a high incidence of tuberculosis, so the potential coexistence of these two conditions should be explored (see [Chapter 7](#)).

Sleep Apnea and Snoring. Patients with obstructive sleep apnea (OSA) are at increased risk for hypertension, MI, stroke, diabetes, and car crashes and should receive treatment for the disorder. Symptoms and signs include loud snoring, excessive daytime sleepiness, and witnessed breathing cessation during sleep. Patients who present with these symptoms should be referred to a sleep physician specialist for evaluation and then to a clinician who manages OSA. Obesity and large neck circumference are common risk factors for the disease. The gold standard for treatment is positive airway pressure; however, many patients cannot tolerate this modality. Other treatment options include use of oral appliances and various forms of upper airway surgery (see [Chapter 9](#)).

Musculoskeletal Disease

Arthritis. Many types of arthritis have been identified; the most common of these are osteoarthritis and rheumatoid arthritis. Patients with arthritis may be taking a variety of medications that could influence dental care. NSAIDs, aspirin, corticosteroids, and cytotoxic and immunosuppressive drugs are examples. Tendencies for bleeding and infection should be considered. Chair position may be a factor for physical comfort. Patients with Sjögren syndrome, which may occur with rheumatoid arthritis or independently, have a dry mouth that is often problematic. Patients with Sjögren syndrome also are at increased risk for lymphoma. Patients with arthritis may have problems with manual dexterity and oral hygiene. In addition, patients with arthritis may have involvement of the temporomandibular joints (see [Chapter 20](#)).

Prosthetic Joints. Some patients with artificial joints have been considered to be at risk for infection of the prosthesis subsequent to dental treatment. However, current guidelines do not recommend that prophylactic antibiotics be provided to these patients before any dental treatment that is likely to produce bacteremia (see [Chapter 20](#)).

Endocrine Disease

Diabetes. Patients with diabetes mellitus must be identified to determine the type of diabetes, how it is being treated, and how well controlled it is. Whereas patients with type 1 diabetes require insulin, type 2 diabetes usually

is controlled through diet, oral hypoglycemic agents, or both; however, some patients with type 2 diabetes eventually also require insulin. Those with type 1 diabetes have a greater number of complications and are of greater concern regarding management than are those with type 2 diabetes. Signs and symptoms suggestive of diabetes can be recognized by the dentist and include excessive thirst and hunger, frequent urination, weight loss, and frequent infections. Long-term complications include blindness, hypertension, and kidney failure, each of which also may affect dental management. Understanding the level of control of their diabetes is important. Patients with poorly controlled diabetes typically do not handle infection very well and may have exaggerated periodontal disease. Patients who take insulin are at risk for episodes of hypoglycemia in the dental office if meals are skipped or if stress or infection is present (see [Chapter 14](#)).

Thyroid Disease. Patients who have uncontrolled hyperthyroidism are potentially hypersensitive to stress and the effects of α_1 -adrenergic sympathomimetics, so the use of vasoconstrictors generally is contraindicated. In rare cases, infection or surgery can initiate a thyroid crisis—a serious medical emergency. These patients also may be easily upset emotionally and intolerant of heat, and they may exhibit tremors. An enlarged thyroid gland and exophthalmos may be present. Patients with known hypothyroidism usually are taking a thyroid supplement; this medication regimen helps to stabilize the body's thyroid hormone level. Thyroid cancer is a common form of head and neck cancer that often is curable if detected and treated early. Thus, palpation of the thyroid gland during the head and neck examination is important to detect swelling or nodules (see [Chapter 16](#)).

Genitourinary Tract Disease

Kidney Failure. Patients with chronic kidney disease or a kidney transplant must be identified. The potential for abnormal drug metabolism, immunosuppressive drug therapy, bleeding problems, hepatitis, infection, high blood pressure, concurrent diabetes, and heart failure must be considered in management (see [Chapter 12](#)). Certain drugs that are nephrotoxic should be avoided, and several drugs administered by dentists require dosage adjustment when kidney function is low. Patients on hemodialysis do not require antibiotic prophylaxis but do receive heparin, which can prolong bleeding during and after invasive procedures.

Sexually Transmitted Diseases. A variety of sexually transmitted diseases such as syphilis, gonorrhea, and HIV/AIDS can have manifestations in the oral cavity because of oral–genital contact or secondary to hematogenous dissemination in the blood or immune suppression. The dentist may be the first to identify these conditions. In addition, some sexually transmitted diseases, including HIV infection, hepatitis B and C, and syphilis, can be transmitted to the dentist through direct contact with

oral lesions, infectious blood, or improperly sterilized instruments (see [Chapters 10, 13, and 18](#)).

Other Conditions and Factors

Tobacco and Alcohol Use. Use of tobacco products is a risk factor associated with cancer, cardiovascular disease, pulmonary disease, and periodontal disease. Patients who use tobacco products should be asked whether they would like to quit and should be encouraged to do so (see [Chapter 8](#)). The dentist should provide assistance for patients who are interested in smoking cessation. Excessive use of alcohol is a risk factor for periodontal disease, malignancy, and heart disease and may lead to liver disease. The combination of excessive alcohol and tobacco use is a significant risk factor for oral cancer. Alcoholism also can contribute to liver impairment and cirrhosis.

Drug Addiction and Substance Abuse. Patients who have a history of injected drug use are at increased risk for infectious diseases such as hepatitis B or C, HIV/AIDS, and infective endocarditis. Narcotic and sedative medications should be prescribed with caution, if at all, for these patients because of the risk of triggering a relapse. This caveat also applies to patients who are recovering alcoholics. Vasoconstrictors should be avoided in patients who are cocaine or methamphetamine users because the combination may precipitate arrhythmias, MI, or severe hypertension. Patients who abuse prescription narcotics or other controlled substances may engage in “doctor shopping” and drug-seeking activity (see [Chapter 30](#)).

Tumors and Cancer. Patients who have had cancer are at risk for recurrence, so they should be closely monitored. Also, cancer treatment regimens including chemotherapeutic agents or radiation therapy may result in infection, gingival bleeding, oral ulcerations, dry mouth, mucositis, and impaired healing after invasive dental treatment, all of which represent significant management considerations. Patients with a history of intravenous bisphosphonate or antiangiogenic therapy for metastatic bone disease are at risk for medication-related osteonecrosis of the jaw. Invasive procedures should be performed with appropriate caution in these patients (see [Chapter 26](#)).

Radiation Therapy and Chemotherapy. Patients with previous radiation treatment to the head, neck, or jaw must be carefully evaluated because radiation can permanently destroy the blood supply to the jaws, leading to osteoradionecrosis after extraction, trauma or procedures that further compromise blood supply to the jaw. Irradiation of the head and neck can destroy the salivary glands, resulting in decreased saliva, increased dental caries, and mucositis. Fibrosis of masticatory muscles resulting in limited mouth opening also may occur. Chemotherapy can produce many undesirable adverse effects, most commonly a severe mucositis; however, such changes resolve with cessation of the chemotherapeutic agents (see [Chapter 26](#)).

Steroids. Cortisone and prednisone are examples of corticosteroids that are used in the treatment of many

inflammatory and autoimmune diseases. These drugs are important because their use can result in adrenal insufficiency and potentially render the patient unable to mount an adequate response to the stress of an infection or invasive dental procedure such as extractions or periodontal surgery. However, in general, most routine, noninvasive dental procedures do not require administration of supplemental steroids (see [Chapter 15](#)).

Operations or Hospitalizations. A history of hospitalizations can provide a record of past serious illnesses that may have current significance. For example, a patient may have been hospitalized for cardiac catheterization for ischemic heart disease. Another example is that of a patient who is hospitalized for hepatitis C. In both instances, the patient may or may not have received medical follow-up care for the initial problem, so this aspect of the evaluation may be an effective method of identifying an underlying condition. Information about hospitalizations should include diagnosis, treatment, and complications. If a patient has undergone any operation, the reason for the procedure and any associated untoward events such as an anesthetic emergency, unusual postoperative bleeding, infection, or drug allergy should be ascertained.

Pregnancy. Women who are or may be pregnant may need special consideration in dental management. Caution typically is warranted in the taking of radiographs, administration of drugs, and timing of dental treatment. Good oral hygiene is important to maintain during pregnancy for reasons discussed in [Chapter 17](#).

Current Physician

As part of the medical history, information should be sought regarding the identity of the patient’s physician, why the patient is under medical care, diagnoses, and treatment received. If the reason for seeing a physician was the need for a routine physical examination, the patient should be asked whether any problems were discovered and the date of the examination. The name, address, and phone number of the patient’s physician should be recorded for future reference. A patient who does not have a physician may require a more cautious approach than a patient who sees a physician regularly. This is especially true for the patient who has not seen a physician in several years, because of the possibility of the presence of undiagnosed problems. Understanding the health care the patient is receiving also provides insight into the health of the patient and the priorities that person assigns to health care.

Drugs, Medicines, or Pills

All drugs, medicines, supplements, and pills that a patient is taking or is supposed to be taking should be identified and investigated for actions, adverse side effects, and potential drug interactions (see [Appendix D](#)). The interviewer should specifically mention “drugs, medicines, or pills of any kind” because frequently patients do not list

over-the-counter drugs (e.g., aspirin) or herbal medicines (see [Appendix E](#)). The dentist should have a reliable, up-to-date, comprehensive source for drug information, which may be available in print format or through an electronic or web-based resource.

The patient's list of medications ("drug history") may provide the only clues to presence of an unreported medical disorder. The patient may have believed that a particular problem was not important enough to mention or may just have omitted the information inadvertently. The patient may nevertheless report taking medication typically prescribed for a disease. For example, a patient with hypertension may fail to report a history of that problem yet may list medications used to treat hypertension. A patient with previously medically managed condition may have discontinued taking a prescribed medication owing to cost or other reasons, and questioning should uncover this possibility.

Functional Capacity

In addition to asking patients about specific diagnoses, it also is important to ask some screening questions regarding the ability of the patient to engage in normal physical activity (functional capacity). The ability to perform common daily tasks can be expressed in metabolic equivalents of tasks (METs), which quantify the body's use of oxygen. Thus, the patient's ability to meet MET levels as determined for specific activities reflects general physical status. A MET is a unit of oxygen consumption; 1 MET equals 3.5 mL of oxygen per kg of body weight per minute at rest.¹ It has been shown that the risk for occurrence of a serious perioperative cardiovascular event (e.g., MI, heart failure) is increased in patients who are unable to meet a 4-MET demand during normal daily activity.² Daily activities requiring 4 METs include level walking at 4 miles/hour or climbing a flight of stairs. Activities requiring greater than 10 METs include swimming and singles tennis. An exercise capacity of 10 to 13 METs indicates excellent physical conditioning. Thus, a patient who reports an inability to walk up a flight of stairs without shortness of breath, fatigue, or chest pain may be at increased risk for medical complications during dental treatment, especially when such limitation is combined with other risk factors and the patient is under stress.

PHYSICAL EXAMINATION

In addition to a medical history, each dental patient should be afforded the benefits of a simple, abbreviated physical examination to detect signs or symptoms of disease or adverse treatment outcomes. This evaluation should include assessment of general appearance, measurement of vital signs, and an examination of the head and neck.

General Appearance

Much can be learned about the patient's state of health from a purposeful but tactful visual inspection. Careful

observation can lead to awareness and recognition of abnormal or unusual features or medical conditions that may exist and may influence the provision of dental care. This survey consists of an assessment of the general appearance of the patient and inspection of exposed body areas, including the skin, nails, face, eyes, nose, ears, and neck. Each visually accessible area may demonstrate peculiarities that can signal underlying systemic disease or abnormalities.

The patient's outward appearance and movement also can give an indication of her or his general state of health and well-being. Examples of possible trouble are a wasted, cachectic appearance; a lethargic demeanor; ill-kempt, dirty clothing and hair; body odors; a staggering or halting gait; extreme thinness or obesity; bent posture; and difficulty breathing. The dentist should remain sensitive to breath odors, which may be associated with disease such as acetone associated with diabetes, ammonia associated with renal failure, putrefaction of pulmonary infections, and alcohol odor possibly associated with alcohol abuse or alcohol-induced liver disease.

Skin and Nails. The skin is the largest organ of the body; usually, large areas of skin are exposed and accessible for inspection. Changes in the skin and nails frequently are associated with systemic disease. For example, cyanosis can indicate cardiac or pulmonary insufficiency, yellowing (jaundice) may be caused by liver disease, pigmentation may be associated with hormonal abnormalities, and petechiae or ecchymoses can be a sign of a blood dyscrasia or a bleeding disorder ([Fig. 1.1](#)). Alterations in the fingernails, such as clubbing (seen in cardiopulmonary insufficiency) ([Fig. 1.2](#)), white discoloration (seen in cirrhosis), yellowing (from malignancy), and splinter hemorrhages (from infective endocarditis), usually are caused by chronic disorders. The dorsal surfaces of the hands are common sites for actinic keratosis and basal cell carcinomas, as are the bridge of the nose, infraorbital



FIG 1.1 Petechiae and ecchymosis in a patient that may signal a bleeding disorder. (Courtesy of Robert Henry, DMD, Lexington, KY.)



FIG 1.2 Clubbing of digits and nails may be associated with cardiopulmonary insufficiency.



FIG 1.4 Patient with acromegaly.



FIG 1.3 Basal cell carcinomas of the dorsum of the hands and the ala of the nose.

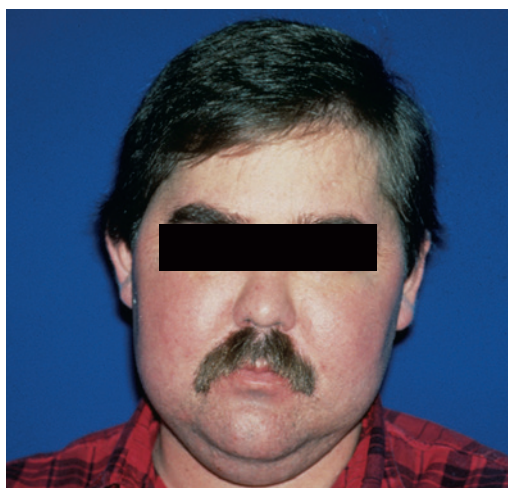

FIG 1.5 Patient who acquired cushingoid facies after several weeks of prednisone administration. (From Bricker SL, Langlais RP, Miller CS: *Oral diagnosis, oral medicine, and treatment planning*, ed 2, Hamilton, Ontario, 2002, BC Decker.)

regions, and the ears (Fig. 1.3). A raised, darkly pigmented lesion with irregular borders may be a melanoma.

Face. The shape and symmetry of the face are abnormal in a variety of syndromes and conditions. Well-recognized examples are the coarse and enlarged features of acromegaly (Fig. 1.4), moon facies in Cushing syndrome (Fig. 1.5), and the unilateral paralysis of Bell palsy (Fig. 1.6).

Eyes. The eyes can be sensitive indicators of systemic disease and should therefore be closely inspected. Patients who wear glasses should be requested to remove them during examination of the head and neck to allow examination of the skin beneath them. Hyperthyroidism may produce a characteristic lid retraction, resulting in a wide-eyed stare (Fig. 1.7). Xanthomas of the eyelids frequently are associated with hypercholesterolemia (Fig. 1.8), as is arcus senilis in older individuals. Scleral yellowing may be caused by liver disease. Reddening of the conjunctiva can result from the sicca syndrome or allergy.

Ears. The ears should be inspected for gouty tophi in the helix and antihelix. An earlobe crease may be an



FIG 1.6 Unilateral facial paralysis in a patient with Bell palsy.



FIG 1.7 Lid retraction from hyperthyroidism.



FIG 1.8 Xanthomas of the eyelids may signal hypercholesterolemia.



FIG 1.9 Malignant melanoma posterior to the ear.

indicator of coronary artery disease. Malignant or pre-malignant lesions (e.g., skin cancer) may be found on and around the ears (Fig. 1.9).

Neck. The neck should be inspected for enlargement and asymmetry. Bilateral palpation of the thyroid gland should be performed (Fig. 1.10). Depending on location and consistency, enlargement may be caused by goiter (Fig. 1.11), infection, cysts (Fig. 1.12), enlarged lymph nodes (Fig. 1.13), malignancy, or vascular deformities.

Vital Signs

Vital signs consist of blood pressure, pulse, respiratory rate, temperature, height, and weight. These should be



FIG 1.10 Bimanual palpation of the anterior neck.



FIG 1.11 Midline neck enlargement from a goiter.

assessed in the dental setting to best ascertain the health of the patient. Nevertheless, height and weight are infrequently recorded in private practice, and temperature usually is measured when infection or systemic disease is suspected.

The benefits of vital sign measurement during an initial examination are twofold. First, the establishment of baseline normal values ensures a standard of comparison in the event of a medical emergency during treatment. If an emergency occurs, knowledge of the patient's normal values is helpful in determination of the severity of the problem. For example, if the unexpected event is a loss of consciousness accompanied by a drop in blood pressure to 90/50 mm Hg, the level of concern will be entirely



FIG 1.12 Midline neck enlargement caused by a thyroglossal duct cyst.

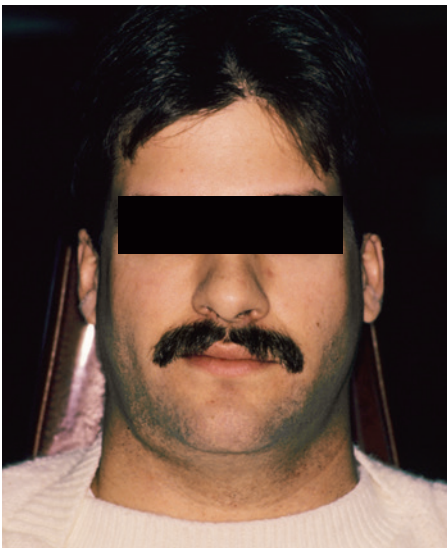

FIG 1.13 Enlarged lymph node beneath the right body of the mandible resulting from a salivary gland infection.

different for a patient whose blood pressure normally is 110/65 mm Hg from that for a patient with hypertension whose blood pressure normally is 180/110 mm Hg. In the second instance, the patient may well be in a state of shock.

A second benefit of vital sign measurement during an examination is in screening for abnormalities, either diagnosed or undiagnosed. For example, if a person with severe, uncontrolled hypertension that was not identified received dental treatment without management alteration, the potential consequences could be serious. The purpose



FIG 1.14 Palpation of the carotid pulse.



FIG 1.15 Palpation of the radial pulse.

of this examination is merely detection of an abnormality—not diagnosis, which is the responsibility of the physician. Abnormal findings should be discussed with the patient, and if significant, the patient should be referred to a physician for further evaluation.

Pulse. The standard procedure for assessing the pulse rate is to palpate the carotid artery at the side of the trachea (Fig. 1.14) or the radial artery on the thumb side of the wrist (Fig. 1.15). The pulse should be palpated for 1 minute so that rhythm abnormalities can be detected. Alternatively, the pulse may be palpated for 30 seconds and the count multiplied by 2. Use of the carotid artery for pulse determination has some advantages. First, the carotid pulse is familiar in clinical practice because of cardiopulmonary resuscitation (CPR) training. Second, it is reliable because it is a large, central artery that supplies the brain; therefore, in emergency situations, it may remain palpable when peripheral arteries in the extremities are not. Finally, the carotid is easily located and palpated because of its size.

The carotid pulse can be palpated along the anterior border of the sternocleidomastoid muscle at approximately the level of the thyroid cartilage. Displacement of the sternocleidomastoid muscle slightly posteriorly allows palpation of the pulse with the examiner's first and middle fingers.

Rate. The average pulse rate in normal adults is 60 to 100 beats/min. A pulse rate greater than 100 beats/min is called *tachycardia*, whereas a slow pulse rate of less than 60 beats/min is called *bradycardia*. An abnormal pulse rate may be a sign of a cardiovascular disorder, but the pulse also may be influenced by anemia, exercise, conditioning, anxiety, drugs, or fever.

Rhythm. The normal pulse is a series of rhythmic beats that occur at regular intervals. When the beats occur at irregular intervals, the pulse is called *irregular*, *dysrhythmic*, or *arrhythmic*. To detect an arrhythmia, palpation of the pulse for 1 full minute is suggested for accuracy.

Blood Pressure. Blood pressure is determined most often by indirect measurement in the upper extremities with a blood pressure cuff and stethoscope (Fig. 1.16). The cuff should be of the correct width to give an accurate recording. The bladder within the cuff ideally should encompass 80% of the circumference of the arm, with the center of the bladder positioned over the brachial artery. The standard cuff width for an average adult arm is 12 to 14 cm. Whereas a cuff that is too small yields falsely elevated values, a cuff that is too large yields falsely low values. Narrower cuffs are available for use with children, and wider cuffs or thigh cuffs are available for use with obese or larger patients. As an alternative for an obese patient, a standard-size cuff can be placed on the forearm below the antecubital fossa, and the radial artery may be palpated so that only the approximate systolic pressure can be determined.³ The blood pressure cuff should not be placed on the arm with an arteriovenous shunt for hemodialysis. Instruments that measure blood pressure at the wrist or on a finger have become popular;



FIG 1.16 Blood pressure cuff and stethoscope in place.

however, their use is not recommended because of potential inaccuracies.³ The stethoscope should be of good standard quality. The bell end (cup) is preferred for auscultation of the brachial artery; however, use of the diaphragm (flat surface) is common in practice and is acceptable.

The auscultation method of blood pressure measurement has gained universal acceptance. This technique, advocated by the AHA, is as follows³: The patient should be comfortably seated without the legs crossed. Before placement of the cuff, the brachial artery is located. The cuff is then placed snugly on the bared upper arm, with the lower border appearing approximately an inch above the antecubital fossa. The standard cuff typically has a mark or arrow that designates the midpoint of the bladder, which is centered above the previously palpated brachial artery (at the medial aspect of the tendon of the biceps). Then, while the radial pulse is palpated, the cuff is inflated until the radial pulse disappears (approximate systolic pressure); it is then inflated an additional 20 to 30 mm Hg. The stethoscope is placed over the previously palpated brachial artery at the bend of the elbow in the antecubital fossa (not touching the cuff), and no sounds should be heard. The pressure release valve is then slowly turned, allowing the needle to fall at a rate of 2 to 3 mm Hg per second. As the needle falls, a point is noted at which beating sounds (Korotkoff sounds) first become audible. The pressure at this point is recorded as the systolic pressure.

As the needle continues to fall, the sound of the beats becomes louder and then gradually diminishes until a point is reached at which a sudden, marked diminution in intensity occurs. The weakened beats are heard for a few moments longer and then disappear altogether (Fig. 1.17). The most reliable index of diastolic pressure is the point

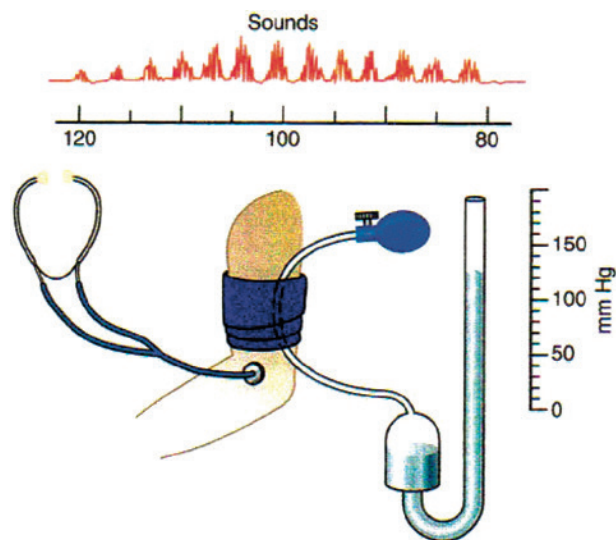

FIG 1.17 The typical sound pattern obtained when blood pressure in a normotensive adult is recorded. (From Guyton AC, Hall JE: *Textbook of medical physiology*, ed 11, Philadelphia, 2006, Saunders.)

at which sound completely disappears. Occasionally, muffled sounds can be heard continuously at pressures far below the true diastolic pressure. When this occurs, the initial point of muffling is used as the diastolic pressure measurement. Pulse pressure is defined as the difference between the systolic and diastolic pressures. In older patients with a wide pulse pressure, Korotkoff sounds may become inaudible between systolic and diastolic pressures and then may reappear as cuff deflation is continued. This phenomenon is known as the *auscultatory gap*.⁴

In an average healthy adult, normal systolic pressure ranges between 90 and 120 mm Hg and generally increases with age. Normal diastolic pressure ranges between 60 and 80 mm Hg. Hypertension in adults is defined as blood pressure of 140/90 mm Hg or greater⁴ (Table 1.1). It is recommended that blood pressure be measured twice during the appointment, separated by several minutes, and the average taken as the final measurement.

Respiration. The rate and depth of respiration should be noted through careful observation of movement of the chest and abdomen in the quietly breathing patient. The respiratory rate in a normal resting adult is approximately 12 to 16 breaths/min. The respiratory rate in small children is higher than that in adults. Notice should be made of patients with labored breathing, rapid breathing, or irregular breathing patterns because all may be signs of systemic problems, especially cardiopulmonary disease. A common finding in apprehensive patients is hyperventilation (rapid, prolonged, deep breathing or sighing), which may result in lowered carbon dioxide levels and may cause disturbing symptoms and signs, including perioral numbness, tingling in the fingers and toes, nausea, a “sick” feeling, and carpopedal spasms.

Temperature. Temperature is not usually recorded during a routine dental examination but rather is determined when a patient has febrile signs or symptoms such as might be found with an abscessed tooth, a mucosal or gingival infection, or a fascial space infection. Normal oral temperature is 98.6°F (37°C) but may vary by as much as plus or minus 1°F over 24 hours and usually is highest in the afternoon. Normal rectal temperature is

about 1°F higher than oral, and normal axillary temperature is about 1°F lower than oral.

Height. The height of patients should be determined so insight into growth and development as well as conditions such as osteoporosis can be assessed.

Weight. Any recent unintentional weight gain or loss should be ascertained, and calculation of body mass index (BMI) should be performed to assess for malnutrition and obesity. A rapid loss of weight may be a sign of malignancy, diabetes, tuberculosis, or other wasting disease. A rapid gain in weight can be a sign of heart failure, edema, hypothyroidism, or neoplasm. Obesity is a risk factor for many health problems, including heart disease and diabetes.

Head and Neck Examination

Examination of the head and neck may vary in its comprehensiveness but should include inspection and palpation of the soft tissues of the oral cavity, maxillofacial region, and neck, as well as evaluation of cranial nerve function. (See standard texts on physical diagnosis for additional descriptions.)

CLINICAL LABORATORY TESTS

Laboratory evaluation can be an important part of the evaluation of a patient’s health status. Whether ordering tests personally or referring the patient to a physician for such testing, the dentist should be familiar with indications for clinical laboratory testing, what tests measure, and what abnormal results mean. When laboratory test results are reported, they are accompanied by normal values for that particular laboratory. Some indications for clinical laboratory testing in dentistry are

- Aiding in the detection of suspected disease (e.g., diabetes, infection, bleeding disorders, malignancy)
- Screening high-risk patients for undetected disease (e.g., diabetes, HIV, chronic kidney disease, hepatitis B or C)
- Establishing normal baseline values before treatment (e.g., anticoagulant status, white blood cells, platelets)

TABLE 1.1 Classification of Blood Pressure (BP) in Adults and Recommendations for Follow-up

BP Classification	Systolic BP (mm Hg)		Diastolic BP (mm Hg)	Recommended Follow-up
Normal	<120	and	<80	Recheck in 2 years.
Prehypertension	120–139	or	80–89	Recheck in 1 year.
Stage 1 hypertension	140–159	or	90–99	Confirm within 2 months.
Stage 2 hypertension	≥160	or	≥100	Evaluate or refer to source of care within 1 month. For patients with higher pressures (e.g., >180/110 mm Hg), evaluation and treatment referral are needed immediately or within 1 week, depending on the clinical situation and complications.

Adapted from the National Heart, Lung, and Blood Institute: *The seventh report of the Joint National Committee on Prevention, Detection, Evaluation, and Treatment of High Blood Pressure: the JNC 7 report*, Bethesda, Maryland, US Department of Health and Human Services, Public Health Service, National Institutes of Health, National Heart, Lung, and Blood Institute, August 2004.

A comprehensive discussion of laboratory tests is beyond the scope of this chapter; however, Table 1.2 lists several common laboratory tests and ranges of normal values. In addition, chairside testing can be performed to assess respiratory capacity, cholesterol, blood glucose, or bleeding potential.

PHYSICIAN REFERRAL AND CONSULTATION

If there are any questions regarding the patient's general health (e.g., medical history, physical examination findings, or laboratory test results suggest an abnormality), contacting the patient's physician for consultation or referral purposes may be warranted. Requests for information should be made in writing by letter or fax if possible; however, a phone call may be more expedient or convenient. The principal advantages of a phone call are the opportunity to obtain immediate information and the chance to ask follow-up questions. Unfortunately, a physician often is not available to take the call, and a nurse or receptionist must relay the response of the physician. It is imperative that the conversation be recorded in the progress notes to ensure inclusion in the permanent record. In addition, a follow-up fax, letter, or email should be sent to the physician summarizing the conversation and asking that any treatment modifications be sent to the office. These communications should be entered in the patient's chart. The advantage of a letter, fax, or email is that it provides a written statement of the physician's reply that can simply be added to the patient record.

Problem List and Diagnoses

After all information is collected, a problem list with diagnoses should be constructed. The problem list should be comprehensive and include final conclusions regarding abnormalities detected after assessment of the chief complaint; medical status; and extraoral, neuromuscular, jaw, mucosal, periodontal, and tooth-related structures. Diagnoses are recorded in the dental record, and these diagnoses dictate the development of the ultimate dental management plan.

RISK ASSESSMENT

Dental management can proceed with or without modifications depending on the overall risk assessment of the patient. We advocate the use of the "ABC" checklist (see Box 1.1), which provides a thoughtful and sequential assessment as to whether the patient can potentially undergo planned dental treatment in a safe manner (risk-benefit profile). One widely used method of assessing medical risk is the American Society of Anesthesiologists (ASA) Physical Classification System.⁵ This system originally was developed to classify patients according to perioperative risk with general anesthesia; however, it has been adapted for outpatient medical and dental use

TABLE 1.2 Clinical Laboratory Tests and Normal Values

Test	Reference Range
Complete Blood Count	
White blood cells	4500–10,000/mL
Red blood cells: male	4.5–5.9 × 10 ⁶ /μL
Red blood cells: female	4.5–5.1 × 10 ⁶ /μL
Platelets	150,000–450,000/μL
Hematocrit: male	41.5–50.4%
Hematocrit: female	35.9–44.6%
Hemoglobin: male	13.5–17.5 g/dL
Hemoglobin: female	12.3–15.3 g/dL
Mean corpuscular volume (MCV)	80–96 μm ³
Mean corpuscular hemoglobin (MCH)	27.5–33.2 pg
Mean corpuscular hemoglobin concentration (MCHC)	33.4%–35.5%
Differential White Blood Cell Count	
	Mean %
Segmented neutrophils	56
Bands	3
Eosinophils	2.7
Basophils	0.3
Lymphocytes	34
Monocytes	4
Hemostasis	
Prothrombin time (PT)	10–13 seconds
Activated partial thromboplastin time (aPTT)	25–35 seconds
Thrombin time (TT)	9–13 seconds
Serum Chemistry	
Glucose, fasting	70–110 mg/dL
Blood urea nitrogen (BUN)	8–23 mg/dL
Creatinine	0.6–1.2 mg/dL
Bilirubin, indirect—unconjugated	0.1–1.0 mg/dL
Bilirubin, direct—conjugated	<0.3 mg/dL
Calcium, total	9.2–11 mg/dL
Magnesium	1.8–3.0 mg/dL
Phosphorus, inorganic	2.3–4.7 mg/dL
Serum Electrolytes	
Sodium	136–142 mEq/L
Potassium	3.8–5.0 mEq/L
Chloride	95–103 mEq/L
Bicarbonate	21–28 mmol/L
Serum Enzymes	
Alkaline phosphatase	20–130 IU/L
Alanine aminotransferase	4–36 U/L
Aspartate aminotransferase	8–33 U/L
Amylase	16–120 Somogyi units/dL
Creatine kinase: male	55–170 U/L
Creatine kinase: female	30–135 U/L

Data from McPherson RA, Pincus MR, editors: *Henry's clinical diagnosis and management by laboratory methods*, ed 21, Philadelphia, Saunders, 2007, pp 1404-1418.

and for all types of surgical and nonsurgical procedures regardless of the type of anesthesia used.

Briefly, the classification is as follows:

ASA I	Normal healthy patient
ASA II	Patient with mild systemic disease (e.g., mild asthma, smoker, well-controlled hypertension, pregnancy). No significant impact on daily activity; unlikely to have an impact on anesthesia and surgery.
ASA III	Patient with severe systemic disease (e.g., kidney disease receiving regular hemodialysis, class 2 heart failure, implanted pacemaker, poorly controlled diabetic). These conditions limit daily activity; probable impact on anesthesia and surgery.
ASA IV	Patient with severe systemic disease that is a constant threat to life (e.g., recent myocardial infarction, stroke, transient ischemic attack [<3 months], ongoing cardiac ischemia, severe valve dysfunction, respiratory failure requiring mechanical ventilation). Serious limitation of daily activity; likely major impact on anesthesia and surgery.

(ASA V is the category for a moribund patient not expected to survive without the operation.

ASA VI includes patient declared brain dead whose organs are being removed for donor purposes.)

The implication is that as the classification level increases (ASA II through IV), so does the risk. Although it generally is helpful to classify patients using the ASA system, the usefulness of this system is limited. Risk assessment more practically involves the evaluation of important patient and treatment factors as shown in [Table 1.3](#). Each factor must be carefully assessed for each patient to determine an accurate risk profile.

It is important to realize that risk assessment is not a cookbook exercise. Each situation requires thoughtful and individual consideration to determine whether the

benefits of having dental treatment outweigh the potential risks to the patient. For example, a patient may have symptomatic heart failure, but the risk is minimal if the planned dental procedure is limited to taking radiographs (noninvasive) and the patient is not anxious or fearful. Conversely, in the same patient, the risk may be significant if the planned procedure is a full-mouth extraction (invasive) and the patient is very anxious. Therefore, the dentist must carefully weigh the physical and emotional state of the patient against the invasiveness, trauma, and pain of the planned procedure. In general, whereas nonsurgical and noninvasive dental procedures carry lower risk, surgical and invasive procedures are associated with higher risk. In addition, the longer the procedure and the greater the blood loss, the greater the risk. Also, more risk is associated with use of conscious sedation and general anesthesia, which can affect the patient's airway, breathing, and level of oxygenation, than with local anesthesia. Again, the question that must be answered is whether the expected benefit of the planned dental treatment outweighs the risk of a medical complication, either occurring during treatment or arising as a result of treatment. Fortunately, in most cases, the benefit of needed dental treatment far outweighs any risk; however, in some instances, the risk can be great enough to mandate deferral of dental treatment.

AGE

Age is an important component of the risk assessment. Young patients may have behavioral and cognitive issues that make it difficult to sit still or take instruction. Also, many young patients weigh less than 75 lb and accordingly need dose reduction for medications and local anesthesia. In contrast, older adults are unique in that they often have multiple comorbid conditions of variable degree, with an increased frequency of nonspecific signs or symptoms, frailty, cognitive impairment, physical disability, and drug management issues (metabolism, interactions, or side effects). Older adults tend to have more medical problems and therefore take more medications. In fact, half of older adults report having two or more chronic illnesses, and one third of all prescription medications are taken by older adults.⁶ Also, this group constitutes a growing segment of the population. It is estimated that by 2030, one in five Americans will be 65 years of age or older.⁷ It is therefore important to be mindful of these realities and approach dental care in older patients with extra consideration and caution, as well as concern for proper drug selection and dosage adjustments as needed.

TREATMENT MODIFICATIONS

After it is decided to provide dental treatment (on the grounds that the expected benefits outweigh the associated risk of a medical complication), modifications may need to be made in the delivery of such treatment. Selection

TABLE 1.3 Risk Assessment Based on Patient and Treatment Factors

Patient Factors	Treatment Factors
Age	Chair position
Nature, severity, control, and stability of the patient's medical condition as determined by the initial evaluation	Drugs administered and drug interactions
Capacity of the patient to respond to a physical or emotional demand	Level of altered consciousness
Emotional, behavioral, and cognitive status of the patient	Invasiveness (type, magnitude, amount of pain and bleeding) of the planned procedure
Severity of orofacial disease	Duration of procedure

of the appropriate treatment modification(s) is the responsibility of the treating dentist. Treatment modifications may include the selection of a drug and amount administered (e.g., provision of antibiotic prophylaxis, anxiolytic drug for an anxious patient, or limiting the amount of vasoconstrictor in a patient who takes a nonselective beta-blocker); the adjustment of the chair position; monitoring of blood pressure, pulse, or respirations; or the use of a topical hemostatic agent. Each decision regarding these modification is based on the patient's risk for airway obstruction; bleeding; difficulty with chair position; disruptive or behavioral issues; drug dosage, metabolism, actions, or interactions; potential for emergencies; functional demand; healing issues; and infection. It is through a systematic assessment of risk and identification of potential problems that simple modifications in the delivery of dental treatment can be made in an effort to reduce risk to the patient. It should be recognized, however, that risk is always increased when a medically compromised patient is treated, and the goal of this book is to provide methods to reduce that risk as much as possible, including the possibility of urgencies or emergencies that can arise in the dental office.

STRESS AND ANXIETY REDUCTION

In all patients, especially those with medical problems, stress and anxiety control are important and help to reduce risk (see [Box 1.2](#)). Establishment of good rapport and trust is of paramount importance. Allowing the patient to ask questions and encouraging frank and open discussions are equally important. Explaining what is to be done before treatment is initiated often helps put the patient at ease. Short morning appointments may be better tolerated than appointments later in the day. In patients with pronounced anxiety or fear about a planned dental procedure, oral premedication with an anxiolytic or sedative drug 1 hour before an appointment is recommended. In addition, an anxiolytic or sedative can be prescribed the night before an appointment to ensure a good night's rest. One of the most commonly used drugs for this purpose is triazolam, a short-acting benzodiazepine. Other drugs such as diazepam, oxazepam, lorazepam, or hydroxyzine also may be used. If an anxiolytic or a sedative is prescribed, patients should be cautioned not to drive or operate machinery while under the influence of the drug. Intraoperative monitoring by pulse oximetry is recommended for those who are sedated with oral medication. In addition to oral premedication, intraoperative inhalation sedation with nitrous oxide–oxygen may be considered for additional anxiolysis and sedation. This may be especially beneficial for patients with cardiovascular disease because oxygen is continuously administered during the procedure.

Injection of local anesthetic is the procedure that most patients fear; therefore, every effort should be made to avoid pain during administration. Keeping the needle and

syringe out of the patient's sight until it is ready to use is important. Topical anesthetic should be applied followed by slow advancement of the needle and slow injection of the solution after aspiration. Adequate time should then be allowed after injection to ensure adequate anesthesia before the start of work. It is imperative to ensure profound local anesthesia to prevent intraoperative pain.

At the completion of the appointment, it should be determined whether postoperative pain is likely; if so, consideration may be given to administering a long-acting local anesthetic (e.g., bupivacaine) before the patient is dismissed. Appropriate analgesia also should be prescribed. Analgesics can be started preemptively, before the procedure, and may provide enhanced effectiveness. Analgesic selection should be based on the patient's current medical conditions and potential drug–drug interactions. Instructions should be provided to the patient, along with a phone number to call if the patient needs to contact the dentist. An especially helpful tactic is to call the patient on the evening of the appointment to see how he or she is doing.

REFERENCES

1. Fletcher GF, Balady G, Froelicher VF, et al. Exercise standards. A statement for healthcare professionals from the American Heart Association Writing Group. *Circulation*. 1995;91:580-615.
2. Fleisher LA, Beckman JA, Brown KA, et al. ACC/AHA 2007 guidelines on perioperative cardiovascular evaluation and care for noncardiac surgery: executive summary: a report of the American College of Cardiology/American Heart Association Task Force on Practice Guidelines (Writing Committee to Revise the 2002 Guidelines on Perioperative Cardiovascular Evaluation for Noncardiac Surgery). *Circulation*. 2007;116:1971-1996.
3. Pickering TG, et al. Recommendations for blood pressure measurement in humans and experimental animals: Part 1: blood pressure measurement in humans: a statement for professionals from the Subcommittee of Professional and Public Education of the American Heart Association Council on High Blood Pressure Research. *Circulation*. 2005;111:697-716.
4. National Heart, Lung, and Blood Institute. The seventh report of the Joint National Committee on Prevention, Detection, Evaluation, and Treatment of High Blood Pressure: the JNC 7 report, Bethesda, Maryland, US Department of Health and Human Services, Public Health Service, National Institutes of Health, National Heart, Lung, and Blood Institute, August 2004.
5. ASA Physical Status Classification System. <https://www.asahq.org/resources/clinical-information/asa-physical-status-classification-system> Accessed 2 February 2016.
6. Miller CS, Kaplan AL, Guest GF, et al. Documenting medication use in adult dental patients: 1987-1991. *J Am Dent Assoc*. 1992;123:40-48.
7. From the Centers for Disease Control and Prevention. Public health and aging: trends in aging—United States and worldwide. *JAMA*. 2003;289:1371-1373.

PART II

Cardiovascular Disease

Infective Endocarditis

DEFINITION

Infective endocarditis (IE) is a microbial infection of the endothelial surface of the heart or heart valves that most often occurs in proximity to congenital or acquired cardiac defects.^{1,2} A clinically and pathologically similar infection that may occur in the endothelial lining of an artery, usually adjacent to a vascular defect (e.g., coarctation of the aorta) or a prosthetic device (e.g., arteriovenous [AV] shunt), is called *infective endarteritis*. Although bacteria most often cause these diseases, fungi and other microorganisms also may cause such infection; thus, the designation *infective* is used in keeping with this multimicrobial origin. The term *bacterial endocarditis* (BE) is in common use, reflecting the fact that most cases of IE are caused by bacteria; however, *IE* has become the preferred nomenclature and is therefore used in this chapter.³⁻⁵

Previously, IE was classified as acute or subacute to reflect the rapidity of onset and duration of symptoms before diagnosis; however, this classification was found to be somewhat arbitrary. It has now largely been replaced by a classification that is based on the causative microorganism (e.g., streptococcal endocarditis, staphylococcal endocarditis, candidal endocarditis) and the type of valve that is infected (e.g., native valve endocarditis [NVE], prosthetic valve endocarditis [PVE]).³⁻⁵ IE also is classified according to the source of infection—that is, whether it is community acquired or hospital acquired—or whether the patient is an intravenous drug user (IVDU).³⁻⁶

Infective endocarditis is a disease of significant morbidity and mortality that is difficult to treat; therefore, emphasis has long been directed toward prevention. Historically, various dental procedures have been reported to be a significant cause of IE because bacterial species found in the mouth frequently have been found to be the causative agent. Furthermore, whenever a patient is given a diagnosis of IE caused by oral flora, dental procedures performed at any point within the previous several months typically have been blamed for the infection. As a result, antibiotics have been administered before certain invasive dental procedures in an attempt to prevent infection. Of note, however, the effectiveness of such prophylaxis in humans has never been substantiated, and evidence remains lacking on the validity of this practice.

COMPLICATIONS

Complications may include heart failure, embolization, stroke, myocardial infarction (MI), peripheral abscesses, failure of organs: septic shock, invasive infection, prosthetic valve dehiscence, heart block, and mycotic aneurysm, and death.

Epidemiology

Infective endocarditis is a serious, life-threatening disease that affects more than 15,000 patients each year in the United States; the overall mortality rate approaches 40%, which is worse than that for many cancers.^{3,7} IE is a relatively rare disease that occurs most frequently in middle-aged and elderly persons and is more common in men than in women. The incidence rate varies with the population studied. In the general population, the incidence has remained relatively stable over the past 3 decades, ranging between 0.16 and 5.4 cases per 100,000 person-years.⁸ A somewhat higher incidence has been reported in several studies.^{9,10} A community study in Minnesota reported an incidence of 5 to 7 cases per 100,000 person-years, and a study in the metropolitan Philadelphia area reported an overall incidence of 11.6 per 100,000 person-years.^{9,10} In the Philadelphia study, the rate of community-acquired IE was found to be 4.45 per 100,000 person-years, which is comparable to that reported in previous studies; however, the higher overall incidence was attributed to a high prevalence of IVDUs in the population studied.⁹

When populations at enhanced risk are considered, the incidence rate is increased. One study reported the lifetime risk of acquiring IE with various conditions.¹¹ In that study, the risk ranged from 5 per 100,000 person-years in the general population to 2160 per 100,000 person-years in patients who underwent surgical replacement of an infected prosthetic valve (Table 2.1). Previously, the most common underlying condition predisposing to endocarditis was rheumatic heart disease (RHD) (Fig. 2.1); however, in developed countries, the frequency of RHD has markedly declined over the past several decades, and this disorder has become a much less significant factor. Mitral valve prolapse (MVP) (Fig. 2.2), which accounts for 25% to 30% of adult cases of NVE, is now the most common underlying condition among patients who acquire IE.⁵

TABLE 2.1 Lifetime Risk of Acquiring Infective Endocarditis

Predisposing Condition or Factor	No. of Patients/100,000 Patient-Years
General population	5
MVP without audible cardiac murmur	4.6
MVP with audible murmur of mitral regurgitation	52
Rheumatic heart disease	380–440
Mechanical or bioprosthetic valve	308–383
Cardiac valve replacement surgery for native valve	630
Previous endocarditis	740
Prosthetic valve replacement in patients with PVE	2160

MVP, Mitral valve prolapse; PVE, prosthetic valve endocarditis. Data from Steckelberg JM, Wilson WR: Risk factors for infective endocarditis, *Infect Dis Clin North Am* 7:9-19, 1993.

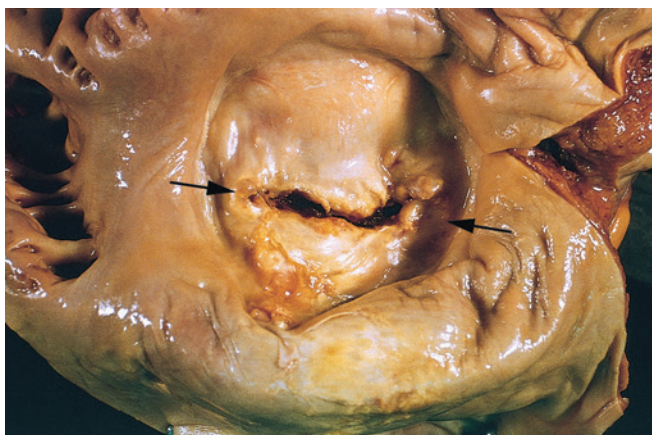

FIG 2.1 Mitral stenosis with diffuse fibrous thickening and distortion (arrows) of the valve leaflets in chronic rheumatic heart disease. (From Schoen FJ, Mitchell RN: *The heart*. In Kumar V, et al, editors: *Robbins and Cotran pathologic basis of disease*, ed 8, Philadelphia, 2010, Saunders.)

Aortic valve disease (either stenosis or regurgitation or both) (Fig. 2.3) appears to account for about 30% of cases.¹² Congenital heart disease (e.g., patent ductus arteriosus, ventricular septal defect, bicuspid aortic valve) (Fig. 2.4) is the substrate for IE in 10% to 20% of younger adults and in 8% of older adults.¹ Tetralogy of Fallot, the most common type of congenital cyanotic heart disease, generally requiring extensive reconstructive surgery for survival (Fig. 2.5), accounts for fewer than 2% of cases.¹³ The incidence of PVE (Fig. 2.6) is increasing, and this entity accounts for about one third of all cases of IE.¹⁴ Of note, in many patients with IE, a predisposing cardiac condition cannot be identified (Table 2.2).

The incidence of IE among IVDUs ranges from 150 to 2000 per 100,000 person-years.¹⁵ Conversely, among

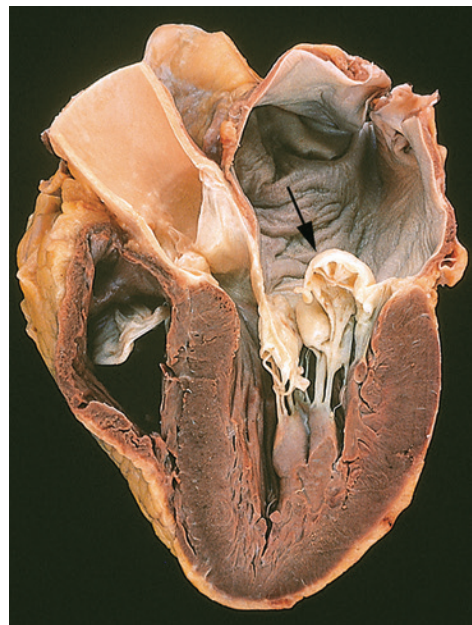

FIG 2.2 Prolapse (arrow) of the posterior mitral valve leaflet into the left atrium. (Courtesy William D. Edwards, MD, Mayo Clinic, Rochester, Minnesota. From Schoen FJ, Mitchell RN: *The heart*. In Kumar V, et al, editors: *Robbins and Cotran pathologic basis of disease*, ed 8, Philadelphia, 2010, Saunders.)



FIG 2.3 Calcific aortic stenosis of a previously normal valve (arrow). Nodular masses of calcium are heaped up within the sinuses of Valsalva. (From Schoen FJ, Mitchell RN: *The heart*. In Kumar V, et al, editors: *Robbins and Cotran pathologic basis of disease*, ed 8, Philadelphia, 2010, Saunders.)

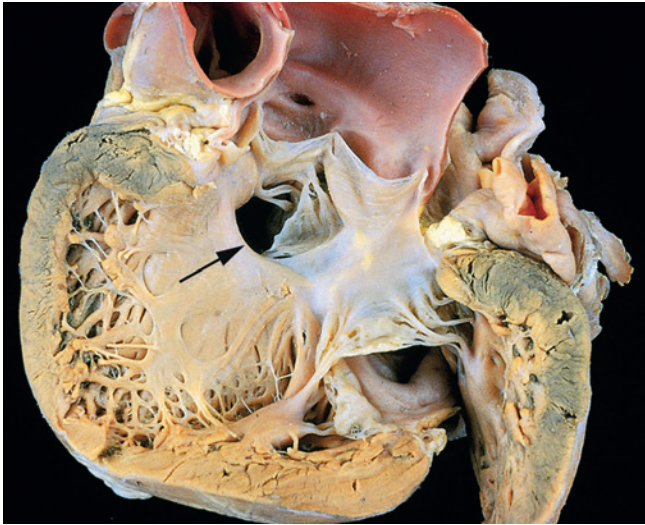

FIG 2.4 Gross photograph of a ventricular septal defect (defect denoted by arrow). (Courtesy of William D. Edwards, MD, Mayo Clinic, Rochester, MN. From Schoen FJ, Mitchell RN: The heart. In Kumar V, et al, editors: *Robbins and Cotran pathologic basis of disease*, ed 8, Philadelphia, 2010, Saunders.)

TABLE 2.2 Predisposing Conditions Associated With Infective Endocarditis (IE)

Underlying Condition	Frequency of IE (%)
Mitral valve prolapse	25–30
Aortic valve disease	12–30
Congenital heart disease	10–20
Prosthetic valve	10–30
Intravenous drug abuse	5–20
No identifiable condition	25–47

patients with IE, the concomitant rate of intravenous (IV) drug abuse ranges from 5% to 20%.¹⁶ Several unique features characterize the IE in IVDUs.^{6,17} In most cases, the cardiac valves are normal before infection. Such infection usually affects the valves of the right side of the heart (tricuspid), and *Staphylococcus aureus* is the most common pathogen.^{18,19} Thus, because of these unique characteristics, IE in IVDUs historically has not been linked to dental treatment.

ETIOLOGY

About 90% of community-acquired cases of native valve IE are caused by streptococci, staphylococci, or enterococci, with streptococci being the most common causative organisms.⁸ In IE associated with IV drug abuse or secondary to health care contact, staphylococci are the most common pathogen identified.⁶ Overall, streptococci continue to be the most common cause of IE, but staphylococci have been gaining increasing importance. *Viridans*

streptococci (α -hemolytic streptococci), constituents of the normal oral flora and gastrointestinal (GI) tract, remain the most common cause of community-acquired NVE, without regard for IV drug abuse, and they cause 30% to 65% of cases of IE.¹ The species that most commonly cause endocarditis are *Streptococcus sanguis*, *Streptococcus oralis* (*mitis*), *Streptococcus salivarius*, *Streptococcus mutans*, and *Gemella morbillorum* (formerly called *Streptococcus morbillorum*). Group D streptococci, which include *Streptococcus bovis* and the enterococci (*Enterococcus faecalis*), are normal inhabitants of the GI tract and account for 5% to 18% of cases of IE. *Streptococcus pneumoniae* has decreased in prevalence and now accounts for only 1% to 3% of cases of IE.²⁰ Group A β -hemolytic streptococci rarely cause IE.¹

Staphylococci are the cause of at least 30% to 40% of cases of IE; of these, 80% to 90% are caused by coagulase-positive *S. aureus*.⁷ *S. aureus*, the cause of most cases of acute IE, is the most common pathogen in IE associated with IV drug abuse. It also is the most common pathogen in nonvalvular cardiovascular device infections.²¹ Of note, *S. aureus* is not a normal constituent of the oral flora. In PVE, staphylococci are the most common pathogens in early and intermediate infections; however, streptococci predominate in late PVE. The proportion of cases of *S. aureus*-related IE appears to be increasing at community-based and university hospitals. This increase appears to be due in large part to increasing health care contact, such as through surgical procedures or the use of indwelling catheters.

Other microbial agents that less commonly cause IE include the HACEK group (*Haemophilus*, *Actinobacillus*, *Cardiobacterium*, *Eikenella*, *Kingella*), *Pseudomonas aeruginosa*, *Corynebacterium pseudodiphtheriticum*, *Listeria monocytogenes*, *Bacteroides fragilis*, and fungi.^{22,23}

PATHOPHYSIOLOGY AND COMPLICATIONS

Although the precise mechanism whereby IE occurs has not been fully elucidated, it is thought to be the result of a series of complex interactions of several factors involving endothelium, bacteria, and the host immune response. The sequence of events leading to infection usually begins with injury or damage to an endothelial surface, most often of a cardiac valve leaflet. Although IE can occur on normal endothelium, most cases begin with a damaged surface, usually in proximity to an anatomic defect or prosthesis. Endothelial damage can result from any of a variety of events, including the following¹:

- Directed flow from a high-velocity jet onto the endothelium
- Flow from a high- to a low-pressure chamber
- Flow across a narrowed orifice at high velocity

Fibrin and platelets then adhere to the roughened endothelial surface, where they form small clusters or masses, resulting in a condition called nonbacterial

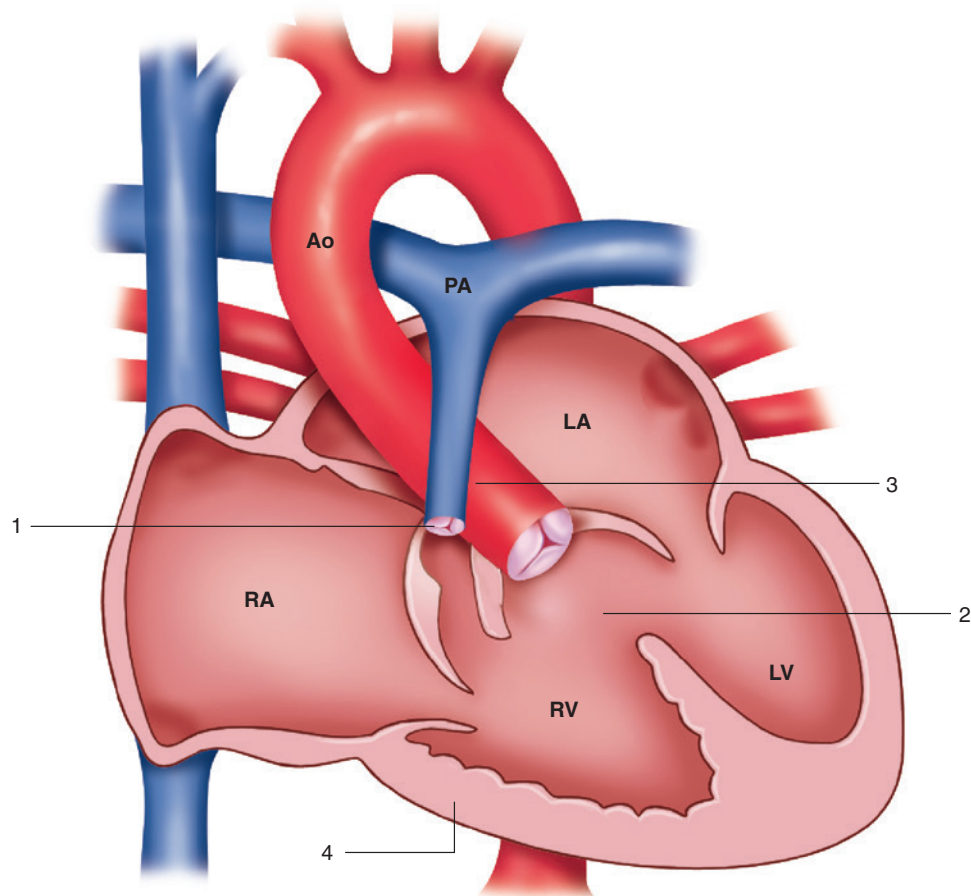

FIG 2.5 Tetralogy of Fallot. 1, Pulmonary stenosis. 2, Ventricular septal defect. 3, Overriding aorta. 4, Right ventricular hypertrophy. Ao, Aorta; LA, left atrium; LV, left ventricle; PA, pulmonary artery; RA, right atrium; RV, right ventricle. (Redrawn from Mullins CE, Mayer DC: *Congenital heart disease: a diagrammatic atlas*, New York, 1988, Wiley-Liss.)

thrombotic endocarditis (NBTE) (Fig. 2.7). A similar and frequently indistinguishable condition is found in some patients with systemic lupus erythematosus and is called Libman-Sacks verrucous endocarditis. Initially, these masses are sterile and do not contain microorganisms. With the occurrence of a transient bacteremia, however, bacteria can be seeded into and adhere to the mass. Additional platelets and fibrin are then deposited onto the surface of the mass, which serves to sequester and protect the bacteria, which undergo rapid multiplication within the protection of the vegetative mass (Fig. 2.8). After the vegetative process is established, the metabolic activity and cellular division of the bacteria are diminished, which decreases the effectiveness of antibiotics. Bacteria are slowly and continually released from the vegetations and shed into the bloodstream, resulting in a continuous bacteremia; fragments of the friable vegetations break off and embolize. A variety of host immune responses to bacteria may occur. This sequence of events results in the clinical manifestations of IE.

The clinical outcome of IE depends on several factors, including¹

- Local destructive effects of intracardiac (valvular) lesions
- Embolization of vegetative fragments to distant sites, resulting in infarction or infection
- Hematogenous seeding of remote sites during continuous bacteremia
- Antibody response to the infecting organism, with subsequent tissue injury caused by deposition of preformed immune complexes or antibody-complement interaction with antigens deposited in tissues

Although combination antibiotic and surgical treatment is effective for many patients, complications are common and serious. The most common complication of IE, and the leading cause of death, is heart failure, which results from severe valvular dysfunction. This pathologic process most commonly begins as a problem with aortic valve involvement followed by mitral and then tricuspid valve infection. Embolization of vegetation fragments often leads to further complications such as stroke. MI can occur as the result of embolism of the coronary arteries, and distal emboli can produce peripheral metastatic abscesses. Pulmonary emboli, usually septic in nature,

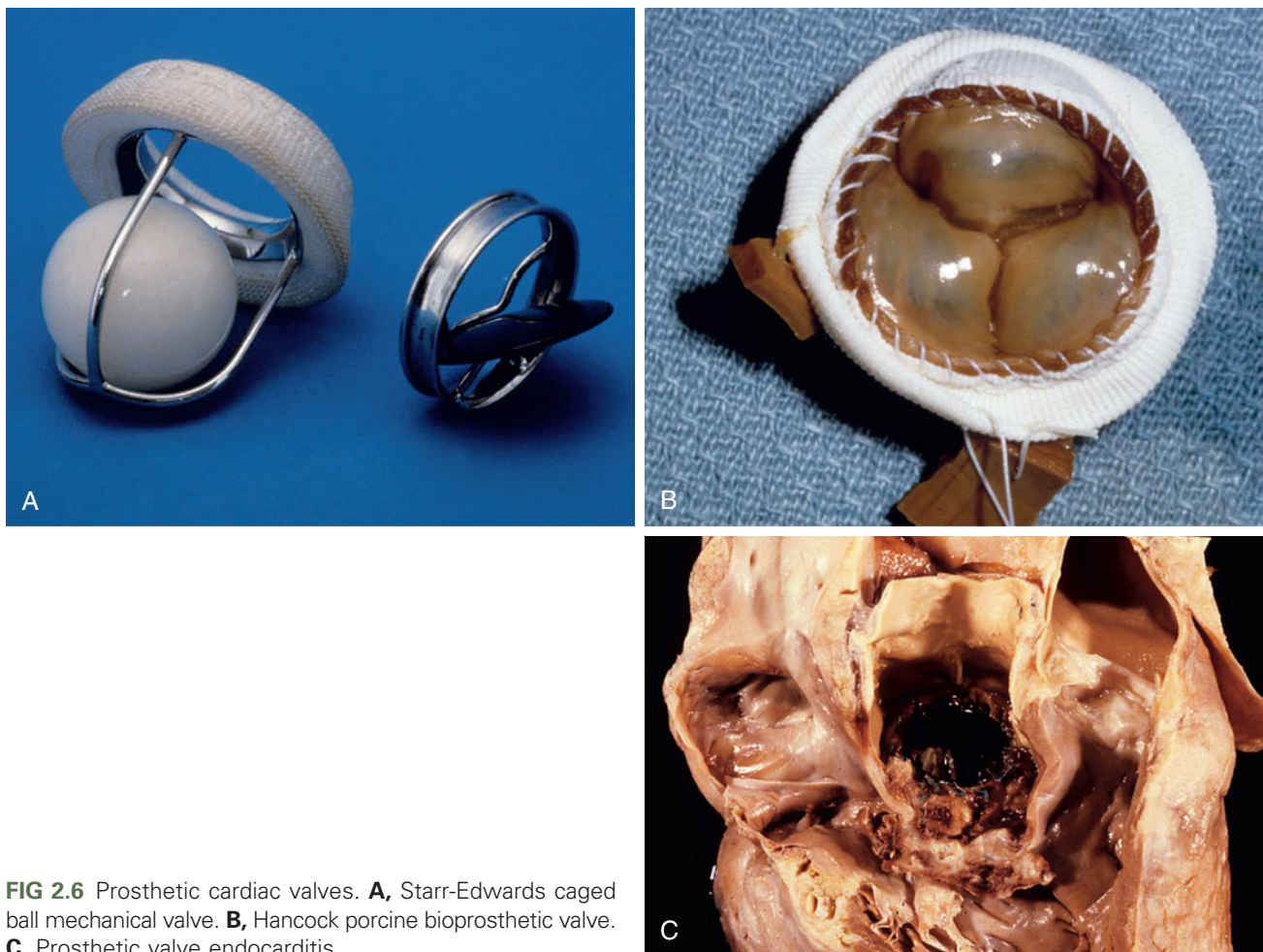

FIG 2.6 Prosthetic cardiac valves. **A**, Starr-Edwards caged ball mechanical valve. **B**, Hancock porcine bioprosthesis valve. **C**, Prosthetic valve endocarditis.

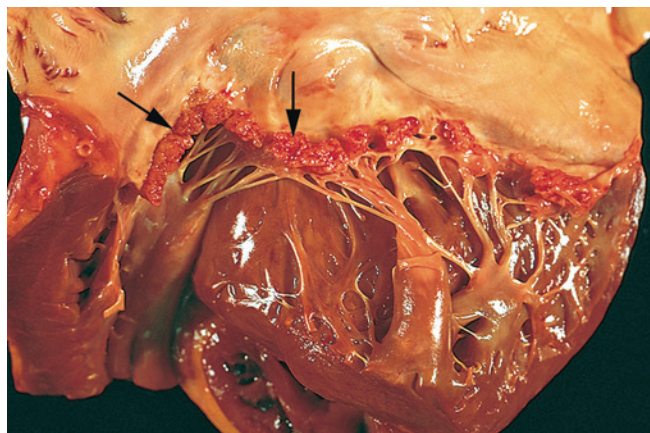

FIG 2.7 Nonbacterial thrombotic endocarditis (arrows). (From Schoen FJ, Mitchell RN: The heart. In Kumar V, et al, editors: *Robbins and Cotran pathologic basis of disease*, ed 8, Philadelphia, 2010, Saunders.)

occur in 66% to 75% of IVDUs who have tricuspid valve endocarditis.¹⁹ Emboli also may involve other systemic organs, including the liver, spleen, and kidney, as well as abdominal mesenteric vessels. The incidence of embolic events is markedly reduced by the prompt initiation of antibiotic therapy.¹ Renal dysfunction also is common



FIG 2.8 Viridans streptococcal endocarditis of the mitral valve. (Courtesy of W. O'Conner, MD, Lexington, KY.)

and may be due to immune complex glomerulonephritis or infarction.²⁴

CLINICAL PRESENTATION

Signs and Symptoms

The classic findings in IE include fever, heart murmur, and positive blood culture, although the clinical presentation



FIG 2.9 Petechiae in infective endocarditis. (From Fowler VG Jr, Bayer AS: Infective endocarditis. In Goldman L, Ausiello D, editors: *Cecil medicine*, ed 23, Philadelphia, 2008, Saunders.)

may vary. Of particular significance is that the interval between the presumed initiating bacteremia and the onset of symptoms of IE is estimated to be less than 2 weeks in more than 80% of patients with IE.^{1,2,5} In many cases of IE that have been purported to be caused by dentally induced bacteremia, the interval between the dental appointment and the diagnosis of IE has been much longer than 2 weeks (sometimes months), so it is very unlikely that the initiating bacteremia was associated with dental treatment.

Fever, the most common sign of IE, occurs in up to 80% to 95% of patients.⁸ It may be absent, however, in older adults and in patients with heart failure or renal failure. New or changing heart murmurs, systolic or diastolic, are found in 80% to 85% of patients.¹ Heart murmurs often are not heard initially in patients who are IVDUs but appear later in the course of the disease. This sequence is characteristic of tricuspid valve IE caused by *S. aureus*. Peripheral manifestations of IE caused by emboli or immunologic responses are less frequently seen since the advent of antibiotics. These include petechiae of the palpebral conjunctiva, the buccal and palatal mucosa, and the extremities (Fig. 2.9), Osler nodes (small, tender, subcutaneous nodules that develop in the pulp of the digits) (Fig. 2.10), Janeway lesions (small, erythematous or hemorrhagic, macular nontender lesions on the palms and soles), splinter hemorrhages in the nail beds (Fig. 2.11), and Roth spots (oval retinal hemorrhages with pale centers) (Fig. 2.12). Other signs include splenomegaly and clubbing of the digits (Fig. 2.13). Sustained bacteremia is typical of IE, and blood culture results are positive in most cases. Although up to 30% of cases of IE initially are found to be “culture negative,” when strict diagnostic criteria are used, only 5% of cases are culture negative.²⁶ Many patients with negative blood cultures have taken antibiotics before the diagnosis of IE. Three separate



FIG 2.10 Osler node in infective endocarditis. (From Fowler VG Jr, Bayer AS: Infective endocarditis. In Goldman L, Ausiello D, editors: *Cecil medicine*, ed 23, Philadelphia, 2008, Saunders.)



FIG 2.11 Splinter hemorrhages of the nail beds in infective endocarditis. (From Porter SR, et al: *Medicine and surgery for dentistry*, ed 2, London, 1999, Churchill Livingstone.)

sets of blood cultures obtained over a 24-hour period are recommended in the evaluation of a patient for suspected IE.²⁷

The diagnosis of IE should be considered for a patient with fever along with one or more of the following cardinal elements of IE: a predisposing cardiac lesion or behavior pattern, bacteremia, embolic phenomena, and evidence of an active endocardial process.¹ The clinical presentation in IE is variable, and other conditions can cause similar signs and symptoms. The Duke criteria were developed and later modified to facilitate the definitive diagnosis of IE.²⁷⁻²⁹ Application of this set of diagnostic criteria involves ascertaining the presence or absence of major and minor criteria.

Major criteria are two of the aforementioned cardinal elements:

- Positive blood cultures
- Evidence of endocardial involvement (e.g., positive findings on echocardiography, presence of new valvular regurgitation)

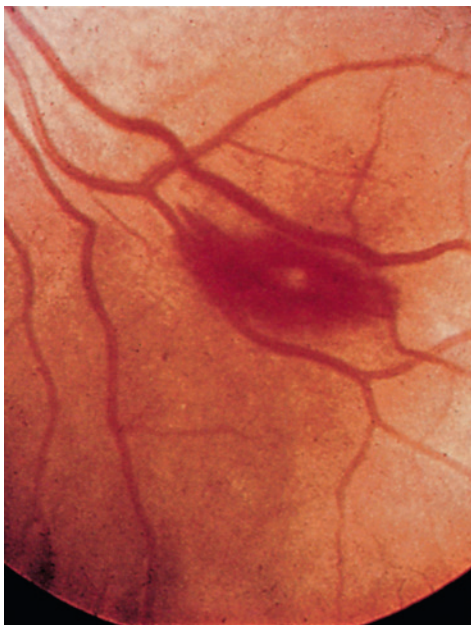

FIG 2.12 A Roth spot in the retina in infective endocarditis. (From Forbes CD, Jackson WF: *Color atlas and text of clinical medicine*, ed 3, Edinburgh, 2003, Mosby.)

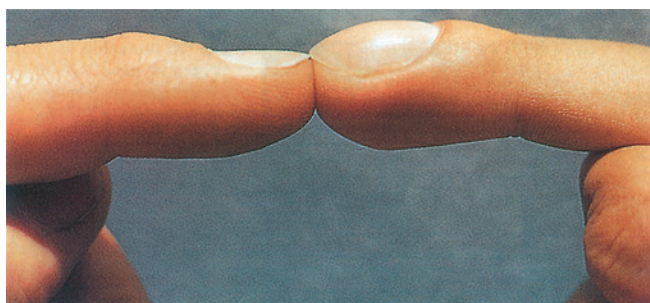

FIG 2.13 Nail clubbing may appear within a few weeks of development of infective endocarditis. (From Zipes DP, et al, editors: *Braunwald's heart disease: a textbook of cardiovascular medicine*, ed 7, Philadelphia, 2005, Saunders.)

Minor criteria include the following factors:

- Predisposing heart condition or IV drug use
- Fever
- Vascular phenomena, including embolic events
- Immunologic phenomena
- Microbiologic evidence other than positive blood culture

Definitive diagnosis of IE requires the presence of two major criteria, one major and three minor criteria, or five minor criteria.²⁹

Laboratory and Diagnostic Findings

In addition to blood culturing, the diagnosis of IE is aided by a complete blood count with differential, electrolyte panel, renal function tests, urinalysis, plain chest radiography, and electrocardiography (ECG).^{1,8} Patients with IE frequently are found to have a normocytic, normochromic anemia that tends to worsen as the disease

progresses. The white blood cell (WBC) count may or may not be elevated. Urinalysis often reveals microscopic hematuria and proteinuria. Appearance on chest radiographs may be abnormal with evidence of heart failure. ECG may show evidence of conduction block with myocardial involvement or infarction. Other abnormal findings may include an elevated erythrocyte sedimentation rate, increased immune globulins, circulating immune complexes, and positive rheumatoid factor.

Echocardiography, transthoracic or transesophageal, is used to confirm the presence of vegetation in patients suspected of having IE; it has become a cornerstone in the diagnostic process. Echocardiographic evidence of vegetation is one of the major findings included in the Duke criteria.²⁹

MEDICAL MANAGEMENT

Before the advent of antibiotics, IE almost always was fatal. This poor outcome has changed dramatically with early diagnosis and the institution of antibiotic therapy or surgical treatment (or both). Although the survival rate has greatly improved, the overall mortality rate hovers around 40%.⁷ However, Wallace et al reported a higher survival rate with mortality at discharge of 18% and at 6 months of 27%.³⁰ The duration of illness before admission, age, sex, valve infected, infecting organism, and left ventricular function were not predictors of adverse mortality rates. However, abnormal WBC count, serum albumin concentration, serum creatinine concentration, or cardiac rhythm, the presence of two major Duke criteria, or visible vegetation conferred a poor prognosis.³⁰ The mortality rate varies significantly among groups of patients with IE of differing causes. For example, for viridans group streptococcal PVE, the reported mortality rate is approximately 20%, but for viridans group streptococcal NVE, it is 5% or less.²⁰ For *S. aureus* endocarditis in non-IVDU patients, the mortality rate ranges between 25% and 40%, and for fungal endocarditis, the mortality rate exceeds 80%. For IE of the tricuspid valve in IVDUs, the mortality rate is between 2% and 4%.¹⁹ The current medical and surgical treatment of IE is presented in [Table 2.3](#). The management of patients with IE requires effective antibiotic therapy and, in cases involving significant structural damage, surgical intervention.³¹⁻³³

Most strains of viridans streptococci, “other” streptococci (including *Streptococcus pyogenes*), and nonenterococcal group D streptococci (primarily *S. bovis*) are exquisitely sensitive to penicillins, with a minimal inhibitory concentration (MIC) of less than 0.2 µg/mL. Bacteriologic cure rates of 98% or higher may be anticipated in patients who complete 4 weeks of therapy with parenteral penicillin or ceftriaxone for NVE caused by highly penicillin-susceptible viridans group streptococci or *S. bovis*. The addition of gentamicin sulfate to penicillin exerts a synergistic killing effect on viridans group streptococci and *S. bovis*. A 2-week regimen of penicillin

TABLE 2.3 Treatment for Infective Endocarditis

Organism and Regimen*	Comments
PCN-SUSCEPTIBLE VIRIDANS STREPTOCOCCI (MIC ≤0.1 µg/mL) AND STREPTOCOCCUS GALLOLYTICUS (FORMERLY S. BOVIS)	
<ol style="list-style-type: none"> 1. PCN 2–3 million units IV q4h × 4 wk 2. Ceftriaxone 2 g IV qd × 4 wk 3. PCN 2–3 million units IV q4h × 2 wk plus gentamicin 1 mg/kg IV q8h × 2 wk 4. PCN 2–4 million units IV q4h × 4 wk plus gentamicin 1 mg/kg IV q8h for at least 2 wk with ID input 5. Vancomycin 15–20 mg/kg IV q8–12h × 4 wk 	<ol style="list-style-type: none"> 1. Also effective for other PCN-susceptible nonviridans streptococci 2. Uncomplicated infection with viridans streptococci in a candidate for outpatient therapy; also for those with PCN allergy 3. Uncomplicated infection with none of the following features: renal insufficiency, eighth cranial nerve deficit, prosthetic valve infection, CNS complications, severe heart failure, age >65 yr; also not acceptable for nutritionally variant streptococci 4. Nutritionally variant strain; for prosthetic valve, give 6 wk of PCN 5. For PCN allergy; goal trough level of 15–20 mg/L
RELATIVELY PCN-RESISTANT VIRIDANS STREPTOCOCCI (MIC 0.12–<0.5 µg/mL)	
<ol style="list-style-type: none"> 1. PCN 4 million units IV q4h × 4 wk plus gentamicin 1 mg/kg IV q8h × 2 wk 2. Vancomycin 15–20 mg/kg IV q8–12h × 4 wk 	<ol style="list-style-type: none"> 2. For PCN allergy or to avoid gentamicin; goal trough level of 15–20 mg/L
ENTEROCOCCI† AND PCN-RESISTANT VIRIDANS STREPTOCOCCI (PCN MIC >0.5 µg/mL)	
<ol style="list-style-type: none"> 1. PCN[‡] 18–30 million units IV per day in divided doses × 4–6 wk or ampicillin 12 g/24 hr IV in 6 equally divided doses plus gentamicin 1 mg/kg IV q8h × 4–6 wk 2. Vancomycin 15–20 mg/kg IV q8–12h × 6 wk plus gentamicin 1 mg/kg q8h × 6 wk[§] 3. Ampicillin 12 g/24 h IV in 6 equally divided doses plus ceftriaxone 2 g IV q12h 	<ol style="list-style-type: none"> 1. Increase duration of both drugs to 6 wk for prosthetic valve infection or symptoms >3 mo in enterococcal infection 2. For PCN allergy; PCN desensitization is also an option; high risk of nephrotoxicity with this regimen 3. PCN-susceptible, aminoglycoside-resistant enterococci or patients who have significant underlying renal disease
STAPHYLOCOCCUS AUREUS	
<ol style="list-style-type: none"> 1. Nafcillin 2 g IV q4h × 4–6 wk 2. Vancomycin 15–20 mg/kg IV q8–12h × 6 wk 3. Nafcillin 2 g IV q4h × 2 wk plus gentamicin 1 mg/kg IV q8h × 2 wk 4. Nafcillin 2 g IV q4h × >6 wk plus gentamicin 1 mg/kg IV q8h × 2 wk plus rifampin 300 mg PO/IV q8h × ≥6 wk 5. Cefazolin 2 g IV q8h × 4–6 wk 6. Daptomycin 6 mg/kg IV qd × 14–42 days 	<ol style="list-style-type: none"> 1. Methicillin-susceptible strain; omit gentamicin if significant renal insufficiency 2. PCN allergy (immediate hypersensitivity or anaphylaxis) or MRSA 3. Methicillin-susceptible strain; 2-wk regimen only for use in IV drug abusers with only tricuspid valve infection, no renal insufficiency, and no extrapulmonary infection 4. Prosthetic valve infection with methicillin-susceptible strain; use vancomycin instead of nafcillin for MRSA 5. PCN allergy other than immediate hypersensitivity <p>Daptomycin is FDA approved for treatment of right-sided <i>S. aureus</i> infective endocarditis; for adults, some experts recommend 8–10 mg/kg IV</p>
COAGULASE-NEGATIVE STAPHYLOCOCCI, PROSTHETIC VALVE INFECTION	
HACEK Strains	
<ol style="list-style-type: none"> 1. Ceftriaxone 2 g IV qd × 4 wk; 6 wk for prosthetic valves 2. Ampicillin–sulbactam 3 g IV q6h × 4 wk; 6 wk for prosthetic valves 	<ol style="list-style-type: none"> 2. HACEK strains increasingly may produce β-lactamase
Non-HACEK Gram-Negative Bacilli	
Enterobacteriaceae	
<ol style="list-style-type: none"> 3. Extended-spectrum PCN or cephalosporin plus aminoglycosides for susceptible strains 	Treat for a minimum of 6–8 wk; some species exhibit inducible resistance to third-generation cephalosporins; valve surgery is required for most patients with left-sided endocarditis caused by gram-negative bacilli; consultation with a specialist in infectious diseases is recommended
Pseudomonas Aeruginosa	
High-dose tobramycin (8 mg/kg/day IV or IM in once-daily doses) with maintenance of peak and trough concentrations of 15–20 µg/mL and ≤2 µg/mL, respectively, in combination with an extended-spectrum PCN (e.g., ticarcillin, piperacillin, azlocillin); ceftazidime, cefepime, or imipenem in full doses; or imipenem	Treat for a minimum of 6–8 wk; early valve surgery usually required for left-sided <i>Pseudomonas</i> endocarditis; consultation with a specialist in infectious diseases is recommended

TABLE 2.3 Treatment for Infective Endocarditis—cont'd

Organism and Regimen*	Comments
Fungi	
Treatment with a parenteral antifungal agent (usually a lipid-containing amphotericin B product, 3–5 mg/kg/day IV for at least 6 weeks) and valve replacement Fluconazole, 400 mg daily PO is an alternative for susceptible yeasts; other azoles, such as voriconazole, may be required for resistant yeasts or molds	Long-term or lifelong suppressive therapy with PO antifungal agents often required; consultation with a specialist in infectious diseases is recommended

*Dosages are for patients with normal renal function; for those with renal insufficiency, adjustments must be made for all drugs except nafcillin, rifampin, and ceftriaxone. Gentamicin doses should be adjusted to achieve a peak serum concentration of approximately 3 µg/mL 30 min after dosing and a trough gentamicin level of <1 µg/mL.

[†]Enterococci must be tested for antimicrobial susceptibility. These recommendations are for enterococci sensitive to PCN, gentamicin, and vancomycin.

[‡]Ampicillin 12 g/day can be used instead of PCN.

[§]The need to add an aminoglycoside has not been demonstrated for PCN-resistant streptococci.

HACEK = *Haemophilus spp.*, *Aggregatibacter spp.* (formerly *Actinobacillus actinomycetemcomitans*) *Cardiobacterium hominis*, *Eikenella corrodens*, and *Kingella spp.*; IM = intramuscular; IV = intravenous; MIC = minimum inhibitory concentration; MRSA = methicillin-resistant *Staphylococcus aureus*; PCN = penicillin; PO = oral; q = every; qd = every day.

Adapted from Baddour LM, Wilson WR, Bayer AS, et al. Infective endocarditis: diagnosis, antimicrobial therapy, and management of complications. *Circulation*. 2005; 111:e394-e433.

or ceftriaxone combined with single-daily-dose gentamicin is appropriate for uncomplicated cases of endocarditis caused by highly penicillin-susceptible viridans group streptococci or *S. bovis* in patients at low risk for adverse events caused by gentamicin therapy. For patients who are unable to tolerate penicillin or ceftriaxone, vancomycin is the most effective alternative.

Patients with endocarditis arising as a complication after surgery for placement of prosthetic valves or other prosthetic material that is caused by a highly penicillin-susceptible strain (MIC of ≤0.12 µg/mL) should receive 6 weeks of therapy with penicillin or ceftriaxone, with or without gentamicin for the first 2 weeks. Those with endocarditis caused by a strain that is relatively or highly resistant to penicillin (MIC >0.12 µg/mL) should receive 6 weeks of therapy with penicillin or ceftriaxone combined with gentamicin. Vancomycin therapy is recommended only for patients who are unable to tolerate penicillin or ceftriaxone.

Regardless of whether IE is community or hospital acquired, most *S. aureus* organisms produce β-lactamase; therefore, the condition is highly resistant to penicillin G. The drug of choice for treatment of IE caused by methicillin-susceptible *S. aureus* (MSSA) is one of the semisynthetic, penicillinase-resistant penicillins such as nafcillin or oxacillin sodium. For patients with native valve *S. aureus* endocarditis, a 6-week course of oxacillin or nafcillin with the optional addition of gentamicin for 3 to 5 days is recommended. Staphylococcal PVE is treated as for NVE, except that treatment is given for a longer period. For strains resistant to oxacillin, vancomycin is combined with rifampin and gentamicin.

Surgical intervention may be necessary to facilitate a cure for IE or to repair damage caused by the infection. Indications for surgery include moderate to severe heart failure caused by valvular dysfunction, unstable or

obstructed prosthesis, infection uncontrollable by antibiotics alone, fungal endocarditis, and intracardiac complications with PVE.^{32,34-36}

DENTAL MANAGEMENT

Antibiotic Prophylaxis

Dental treatment has long been implicated as a significant cause of IE. Conventional wisdom has taught that in a patient with a predisposing cardiovascular disorder, IE most often was caused by a bacteremia that resulted from a dental procedure and that through the administration of antibiotics before those procedures, IE could be prevented. On the basis of these assumptions, over the past half century, the American Heart Association (AHA) has published 10 sets of recommendations for antibiotic prophylaxis for dental patients at risk for acquiring IE³⁷⁻⁴⁶ (Table 2.4). These recommendations, first published in 1955 and revised every few years, varied in terms of identification of risk conditions, selection of antibiotics, timing of antibiotic administration, and route of administration of antibiotics. It is important to recognize that although these recommendations were a rational and prudent attempt to prevent life-threatening infection, they were largely based on circumstantial evidence, expert opinion, clinical experience, and descriptive studies in which surrogate measures of risk were used.²⁵ Furthermore, the effectiveness of these recommendations has never been proved in humans. Recently, accumulating evidence suggests that many of the widely held assumptions on which these previous recommendations were made may not be accurate.

Source and Frequency of Bacteremia. The primary assumption that has driven the previous recommendations was that dental procedures were the source of most of the bacteremias that led to IE; therefore, antibiotics given

TABLE 2.4 Selected Previous Iterations of American Heart Association–Recommended Antibiotic Regimens (1955–1997) for Dental and Respiratory Tract Procedures in Adults

Year	Primary Regimen for Dental Procedures
1955	600,000 U of aqueous PCN and 600,000 U of procaine PCN in oil containing 2% aluminum monostearate administered IM 30 minutes before the operative procedure
1957	For 2 days before surgery, 200,000–250,000 U of PCN by mouth 4 times a day On day of surgery, 200,000–250,000 U by mouth 4 times a day and 600,000 U aqueous PCN with 600,000 units procaine PCN IM 30 minutes before surgery For 2 days after, 200,000–250,000 U by mouth 4 times a day
1960	Step 1: Prophylaxis 2 days before surgery with 600,000 U of procaine PCN IM on each day Step 2: Day of surgery: 600,000 U procaine PCN IM, supplemented by 600,000 U of crystalline PCN IM 1 hour before surgical procedure Step 3: For 2 days after surgery: 600,000 U procaine PCN IM each day
1965	Day of procedure: Procaine PCN 600,000 U, supplemented by 600,000 U of crystalline PCN IM 1 to 2 hours before the procedure For 2 days after procedure: Procaine PCN 600,000 U IM each day
1972	600,000 U of procaine PCN G with 200,000 U of crystalline PCN G IM 1 hour before procedure and once daily for 2 days after the procedure
1977	Aqueous crystalline PCN G (1,000,000 U IM) mixed with procaine PCN G (600,000 U IM); give 30 minutes to 1 hour before procedure and then give PCN V 500 mg orally every 6 hours for two doses
1984	PCN V 2 g PO 1 hour before procedure; then give 1 g 6 hours after initial dose
1990	Amoxicillin 3 g PO 1 hour before procedure; then give 1.5 g 6 hours after initial dose
1997	Amoxicillin 2 g PO 1 hour before procedure

IM, Intramuscular; PCN, penicillin; PO, oral.

From Wilson W, Taubert KA, Gewitz M, et al: American Heart Association Rheumatic Fever, Endocarditis, and Kawasaki Disease Committee; American Heart Association Council on Cardiovascular Disease in the Young; American Heart Association Council on Clinical Cardiology; American Heart Association Council on Interdisciplinary Working Group: Prevention of infective endocarditis: guidelines from the American Heart Association: a guideline from the American Heart Association Rheumatic Fever, Young, and the Council on Clinical Cardiology, Council on Cardiovascular Surgery and Anesthesia, and the Quality Care of Outcomes Research interdisciplinary Working Group, *Circulation* 116(15):1736-1754, 2007.

just before dental procedures would prevent IE. Although it is undisputed that many dental procedures can cause bacteremia,⁴⁷⁻⁵⁰ it also is clear that bacteremia can result from many normal daily activities such as toothbrushing, flossing, manipulation of toothpicks, use of oral water irrigation devices, and chewing⁴⁸⁻⁶⁰ (Table 2.5). Because the average person living in the United States makes fewer than two dental visits per year, it follows that the frequency of and exposure to bacteremia are greater through routine daily activities.²⁵ It is thus likely that the frequency and cumulative duration of exposure to bacteremia from routine daily events over 1 year are much higher than those resulting from a single dental procedure.^{61,62} Accordingly, it is inconsistent to recommend antibiotic prophylaxis for patients undergoing dental procedures (which can be done) but not for these same patients engaging in routine daily activities (which would be impractical or even impossible).²⁵

Magnitude of Bacteremia. Another assumption often made is that the magnitude of bacteremias resulting from dental procedures is more likely to cause IE than that seen with bacteremias resulting from normal daily activities. Published data do not support this contention. Furthermore, the magnitude of bacteremia resulting from dental procedures is relatively low (with bacterial counts of fewer than 10⁴ colony-forming units [CFU]/mL), is similar to that of bacteremia resulting from normal daily

TABLE 2.5 Reported Frequency of Bacteremia Associated With Various Dental Procedures and Oral Manipulation

Dental Procedure or Oral Manipulation	Reported Frequency of Bacteremia (%)
Tooth extraction	10–100
Periodontal surgery	36–88
Scaling and root planing	8–80
Teeth cleaning	≤40
Rubber dam matrix or wedge placement	9–32
Endodontic procedures	≤20
Toothbrushing and flossing	20–68
Use of wooden toothpicks	20–40
Use of water irrigation devices	7–50
Chewing food	7–51

From Wilson W, Taubert KA, Gewitz M, et al: American Heart Association Rheumatic Fever, Endocarditis, and Kawasaki Disease Committee; American Heart Association Council on Cardiovascular Disease in the Young; American Heart Association Council on Clinical Cardiology; American Heart Association Council on Interdisciplinary Working Group: Prevention of infective endocarditis: guidelines from the American Heart Association: a guideline from the American Heart Association Rheumatic Fever, Young, and the Council on Clinical Cardiology, Council on Cardiovascular Surgery and Anesthesia, and the Quality Care of Outcomes Research interdisciplinary Working Group, *Circulation* 116(15):1736-1754, 2007.

activities, and is far less than that (106 to 108 CFU/mL) needed to cause experimental BE in animals.^{50,63,64} It also has been shown that in patients with poor oral hygiene, the frequency of positive blood cultures just before dental extraction was similar to that after extraction.^{65,66} Thus, although the infective dose required to cause IE in humans is unknown, the number of microorganisms in blood after a dental procedure or associated with daily activities is similarly low, and cases of IE caused by oral bacteria probably result from frequent exposure to low inocula of bacteria in the bloodstream, resulting from routine daily activities and not from a dental procedure.²⁵ Also noteworthy is that most patients with viridians streptococci IE have not had a dental procedure performed within the 2 weeks before the onset of symptoms.⁶⁷⁻⁶⁹ These findings imply that emphasis on maintaining good oral hygiene and eradicating dental or oral disease is key to decreasing the frequency of bacteremia produced by normal daily activities. The importance of oral hygiene was demonstrated in studies by Lockhart⁶⁵ and Brennan⁷⁰ and their coworkers, which found that the incidence of bacteremia after toothbrushing was significantly related to poor oral hygiene and gingival bleeding after toothbrushing.⁷¹

Bleeding and Bacteremia

Previous AHA recommendations have suggested that on the basis of the likelihood that significant bleeding will be encountered during the procedure, prophylaxis should be provided for some dental procedures but not for others. This specific recommendation often has been confusing for practitioners and has resulted in conflicting and arbitrary decisions because it is impossible to predict, with any accuracy, the likelihood that significant bleeding will be encountered during a given dental procedure. To add to the confusion, it has been shown that visible bleeding during a dental procedure is not a reliable predictor of bacteremia.⁶² Collective published data suggest that the vast majority of dental office visits result in some degree of bacteremia and that it is not clear which dental procedures are more or less likely to cause transient bacteremia or to result in a greater magnitude of bacteremia than that caused by bacteremia produced by routine daily activities such as chewing food, toothbrushing, or flossing.²⁵

Efficacy of Antibiotic Prophylaxis. The assumption that antibiotics given to at-risk patients before a dental procedure will prevent or reduce a bacteremia that can lead to IE is controversial. Some studies have reported that antibiotics administered before a dental procedure reduced the frequency, nature, or duration of bacteremia,⁷² although others did not.^{48,73-77} More recent studies suggest that amoxicillin therapy has a statistically significant impact on reducing the incidence, nature, and duration of bacteria associated with dental procedures, but it does not eliminate bacteremia.⁷² However, data do not show that such a reduction caused by antibiotic therapy reduces the risk of or prevents IE. Also, prospective, randomized,

placebo-controlled trials have not been conducted to examine the efficacy of antibiotic prophylaxis for preventing IE in patients who undergo dental procedures, and it is highly unlikely that any such studies will ever be done because of the complex logistical, ethical, and medicolegal issues that would be involved. Some retrospective studies, however, have suggested that prophylaxis is beneficial, but these studies are small in size and report insufficient clinical data.²⁵ Also, in many of the cases cited in retrospective studies, the time interval between purported occurrence of bacteremia and onset of symptoms was much longer than 2 weeks.

A study from the Netherlands by van der Meer and colleagues⁷² investigated the efficacy of antibiotic prophylaxis for preventing IE in dental patients with native or prosthetic cardiac valves. Investigators concluded that dental or other procedures probably caused only a small fraction of cases of IE and that prophylaxis would prevent only a small number of cases even if it were 100% effective. In a case-control study undertaken by the same authors,⁷⁸ among patients for whom prophylaxis was provided, 5 of 20 cases of IE occurred despite administration of antibiotics (for a 75% efficacy rate at best), leading to the conclusion that prophylaxis was not effective.

A large, multicenter, case-control study was undertaken in the Philadelphia area by Strom and colleagues⁶⁹ to evaluate the relationship between antibiotic prophylaxis and cardiac risk factors. These investigators concluded that dental treatment was not a risk factor for IE even in patients with valvular heart disease and that few cases of IE could be prevented with prophylaxis even if it were 100% effective. A French study⁷² estimated that only about 2.6% of cases of IE occurred annually in patients undergoing unprotected dental procedures and that a “huge number of prophylaxis doses would be necessary to prevent a very low number of IE cases.”

Risk of Bacterial Endocarditis Due to Dental Procedures. Although the absolute risk for IE caused by a dental procedure is impossible to measure precisely, the best available estimates are as follows²⁵: If dental treatment causes 1% of all cases of IE due to viridians group streptococci annually in the United States, the overall risk in the general population is estimated to be as low as 1 case of IE per 14 million dental procedures. The estimated absolute risk rates for IE caused by a dental procedure in patients with underlying cardiac conditions are as follows: MVP, 1 per 1.1 million procedures; congenital heart disease, 1 per 475,000; rheumatic heart disease, 1 per 142,000; presence of a prosthetic cardiac valve, 1 per 114,000; and previous IE, 1 per 95,000 dental procedures.

Thus, although it has long been assumed that dental procedures may cause IE in patients with underlying cardiac risk factors and that antibiotic prophylaxis is effective, scientific proof to support these assumptions is lacking. The AHA²⁵ has concluded that “of the total number of cases of IE that occur annually, it is likely that an exceedingly small number of these cases are caused

by bacteremia-producing dental procedures. Accordingly, only an extremely small number of cases of IE might be prevented by antibiotic prophylaxis, even if it were 100% effective. The vast majority of cases of IE caused by oral microflora most likely result from random bacteremias caused by routine daily activities.” Thus, on the basis of accumulated available evidence, the AHA in 2007 revised the previous (1997) recommendations.

CURRENT AMERICAN HEART ASSOCIATION RECOMMENDATIONS (2007)²⁵

Patients Recommended to Receive Antibiotic Prophylaxis²⁵

Because published data do not demonstrate convincingly that the administration of prophylactic antibiotics prevents bacteremia from an invasive procedure, it would seem logical that antibiotic prophylaxis should no longer be recommended before dental procedures for any patient. Indeed, a recent Cochrane review⁷⁹ concluded that there is a lack of evidence to support the use of prophylactic penicillin to prevent endocarditis related to dental procedures. However, the AHA notes:

We cannot exclude the possibility that there may be an exceedingly small number of cases of IE that could be prevented by prophylactic antibiotics in patients who undergo an invasive procedure. However, if prophylaxis is effective, such therapy should be restricted to those patients with the highest risk of adverse outcome from IE who would derive the greatest benefit from prevention of IE. In patients with underlying cardiac conditions associated with the highest risk for adverse outcome from IE, IE prophylaxis for dental procedures may be reasonable, even though we acknowledge that the effectiveness is unknown.

A similar approach is advocated in revised Guidelines for the Prevention of Endocarditis by the Working Party of the British Society for Antimicrobial Chemotherapy,⁸⁰ as well as in the 1992 French guidelines.⁸¹ The British document states that in view of the lack of evidence of benefit, the most logical step is to withhold antibiotic prophylaxis for dental procedures. However, it was acknowledged that many clinicians would be reluctant to accept these “radical, but logical” changes, so a compromise was accepted in which prophylaxis would be indicated only for those high-risk patients with the potentially most serious outcomes from IE. Of note, however, in 2008 the National Institute for Health and Clinical Excellence (NICE), which provides guidance for clinical care to the National Health Service in the United Kingdom, did not recommend antibiotic prophylaxis for any at-risk patient undergoing dental treatment.⁸² However, since 2008, an increase in cases of endocarditis noted to be occurring in England has led to NICE recommending

reinstatement of antibiotic prophylaxis for prevention of IE in dental patients.⁸³⁻⁸⁸ Beck and Braunwald reported a similar increase in cases of IE in a nationwide study in the Netherlands, again with the need to reinstate antibiotic prophylaxis.⁸⁹ So far this has not impacted new recommendations by the American Heart Association, which had continued to recommend antibiotic prophylaxis for certain high-risk patients.²⁵

Previous AHA recommendations used the lifetime risk for acquiring IE related to underlying cardiac disorders in the selection of patients to receive antibiotic prophylaxis when undergoing dental procedures (see Table 2.1). Current guidelines, however, recommend antibiotic prophylaxis on the basis of risk of adverse outcomes (significantly increased morbidity and mortality) from IE. Consequently, prophylaxis is recommended only for patients with the potentially most serious outcomes from IE. For example, with viridans group streptococcal or enterococcal IE, outcomes of disease can vary widely, ranging between a relatively benign infection and death, with a mortality rate of less than 5% reported for streptococcal NVE.²⁰ However, patients with those underlying conditions listed in Box 2.1 virtually always experience an adverse outcome, so they are recommended to receive prophylaxis.

BOX 2.1 Cardiac Conditions Associated With the Highest Risk of Adverse Outcomes From Endocarditis for Which Prophylaxis With Dental Procedures Is Recommended

- Prosthetic cardiac valve
- Previous infective endocarditis
- Congenital heart disease (CHD)*
 - Unrepaired cyanotic CHD, including those with palliative shunts and conduits
 - Completely repaired CHD with prosthetic material or device by surgery or catheter intervention during the first 6 months after the procedure†
 - Repaired CHD with residual defects at the site or adjacent to the site of a prosthetic patch or prosthetic device, which inhibits endothelialization
- Cardiac transplant recipients who develop cardiac valvulopathy

*Except for the conditions listed in this box, antibiotic prophylaxis is no longer recommended for any other form of CHD.

†Prophylaxis is recommended because endothelialization of prosthetic material occurs within 6 months after the procedure. From Wilson W, Taubert KA, Gewitz M, et al: American Heart Association Rheumatic Fever, Endocarditis, and Kawasaki Disease Committee; American Heart Association Council on Cardiovascular Disease in the Young; American Heart Association Council on Clinical Cardiology; American Heart Association Council on Interdisciplinary Working Group: Prevention of infective endocarditis: guidelines from the American Heart Association: a guideline from the American Heart Association Rheumatic Fever, Young, and the Council on Clinical Cardiology, Council on Cardiovascular Surgery and Anesthesia, and the Quality Care of Outcomes Research interdisciplinary Working Group, *Circulation* 116(15):1736-1754, 2007.

Dental Procedures for Which Antibiotic Prophylaxis Is Recommended²⁵

Previous AHA recommendations listed specific dental procedures for which antibiotic prophylaxis was recommended on the basis of the likelihood that significant bleeding would be encountered. However, a review of the published data suggests that transient viridans group streptococcal bacteremia may result from any dental procedure that involves manipulation of the gingival or periapical region of the teeth or perforation of the oral mucosa even in the absence of visible bleeding. Therefore, antibiotic prophylaxis is recommended only for patients with conditions listed in [Box 2.1](#) who undergo any dental procedure that involves the manipulation of gingival tissues or the periapical region of a tooth and for those procedures that perforate the oral mucosa ([Box 2.2](#)). This recommendation does not include routine local anesthetic injections through noninfected tissue, taking of dental radiographs, placement of removable prosthodontic or orthodontic appliances, adjustment of orthodontic appliances, or the shedding of deciduous teeth and bleeding from trauma to the lips or oral mucosa.

Antibiotic Prophylaxis Regimens²⁵

In the limited patient population for which antibiotic prophylaxis is recommended, prophylaxis should be directed against viridans group streptococci. Unfortunately,

over the past 2 decades, a significant increase has been noted in the proportion of strains of viridans group streptococci that are resistant to the antibiotics recommended in previous AHA recommendations. In many studies, typical resistance rates of viridans group streptococci for penicillin range from 17% to 50%, for ceftriaxone from 22% to 42%, for macrolides from 22% to 58%, and for clindamycin from 13% to 27%.²⁵ Although these data are indeed alarming, the effect on selection of prophylactic antibiotics is unclear. The AHA states:

The impact of viridans group streptococcal resistance on antibiotic prevention of IE is unknown. If resistance in vitro is predictive of lack of clinical efficacy, the high resistance rates of viridans group streptococci provide additional support for the assertion that prophylactic therapy for a dental procedure is of little, if any, value. It is impractical to recommend prophylaxis with only those antibiotics, such as vancomycin or a fluoroquinolone, that are highly active in vitro against viridans group streptococci. There is no evidence that such therapy is effective for prophylaxis of IE, and their use might result in the development of resistance of viridans group streptococci and other microorganisms to these and other antibiotics.

Antibiotic prophylaxis should be administered in a single dose 30 to 60 minutes before the procedure. If the antibiotic is *inadvertently* not administered before the procedure, the dosage may be administered up to 2 hours after the procedure. [Table 2.6](#) lists the recommended antibiotic regimens for use for dental procedures in patients from [Box 2.1](#). Because of the possibility of cross-allergenicity, the use of cephalosporins is *not* recommended for patients who have a history of anaphylaxis, angioedema, or urticaria (immediate-onset IgE-mediated hypersensitivity) caused by the administration of penicillin. An important point in this context is that the use of antibiotics is not without risk, with the potential for allergic reactions, adverse side effects, and the promotion of antibiotic resistance.

Study results are contradictory regarding the efficacy of oral antimicrobial mouth rinses (e.g., chlorhexidine, povidone-iodine) to reduce the frequency of bacteremia associated with dental procedures; however, the preponderance of evidence suggests that no clear benefit is associated with their use. Of note, however, the British Society for Antimicrobial Therapy guidelines do recommend the preoperative use of chlorhexidine (0.2%) mouthwash, but the NICE guidelines state that chlorhexidine mouth rinses should not be used.⁸⁰

It is important that dentists continue to identify from the medical history patients with cardiac conditions that increase risk for IE, such as MVP, rheumatic heart disease, or systemic lupus erythematosus. Patients with these conditions should be under the care of a physician for

BOX 2.2 Dental Procedures in Patients With Cardiac Conditions for Which Endocarditis Prophylaxis Is Recommended

- All dental procedures that involve manipulation of gingival tissue or the periapical region of teeth or perforation of the oral mucosa
- This includes all dental procedures except the following procedures and events:
 - Routine anesthetic injections through noninfected tissue
 - Taking of dental radiographs
 - Placement of removable prosthodontic or orthodontic appliances
 - Adjustment of orthodontic appliances
 - Shedding of deciduous teeth and bleeding from trauma to the lips or oral mucosa

*See [Box 1.1](#).

From Wilson W, Taubert KA, Gewitz M, et al: American Heart Association Rheumatic Fever, Endocarditis, and Kawasaki Disease Committee; American Heart Association Council on Cardiovascular Disease in the Young; American Heart Association Council on Clinical Cardiology; American Heart Association Council on Interdisciplinary Working Group: Prevention of infective endocarditis: guidelines from the American Heart Association: a guideline from the American Heart Association Rheumatic Fever, Young, and the Council on Clinical Cardiology, Council on Cardiovascular Surgery and Anesthesia, and the Quality Care of Outcomes Research interdisciplinary Working Group, *Circulation* 116(15):1736-1754, 2007.

TABLE 2.6 Antibiotic Regimens for Dental Procedures

Situation	Agent	REGIMEN: SINGLE DOSE 30–60 MINUTES BEFORE PROCEDURE	
		Adults	Children
Oral	Amoxicillin	2 g	50 mg/kg
Unable to take oral medication	Ampicillin or cefazolin or ceftriaxone	2 g IM or IV	50 mg/kg IM or IV
	cefazolin or ceftriaxone	1 g IM or IV	50 mg/kg IM or IV
Allergic to PCNs or ampicillin (oral)	Cephalexin*† or clindamycin	2 g	50 mg/kg
	clindamycin	600 mg	20 mg/kg
	Azithromycin or clarithromycin	500 mg	15 mg/kg
Allergic to PCNs or ampicillin and unable to take oral medication	Cefazolin or ceftriaxone†	1 g IM or IV	50 mg/kg
	Clindamycin phosphate	600 mg IM or IV	20 mg/kg IM or IV

*Or other first- or second-generation oral cephalosporin in equivalent adult or pediatric dosage.

†Cephalosporins should not be used in a person with a history of anaphylaxis, angioedema, or urticaria after receiving penicillins or ampicillin.

IM, Intramuscular; IV, intravenous; PCN, penicillin.

From Wilson W, Taubert KA, Gewitz M, et al: American Heart Association Rheumatic Fever, Endocarditis, and Kawasaki Disease Committee; American Heart Association Council on Cardiovascular Disease in the Young; American Heart Association Council on Clinical Cardiology; American Heart Association Council on Interdisciplinary Working Group: Prevention of infective endocarditis: guidelines from the American Heart Association: a guideline from the American Heart Association Rheumatic Fever, Young, and the Council on Clinical Cardiology, Council on Cardiovascular Surgery and Anesthesia, and the Quality Care of Outcomes Research interdisciplinary Working Group, *Circulation* 116(15):1736-1754, 2007.

monitoring the status of their valvular heart disease and potential complications. The establishment and maintenance of optimal oral hygiene are of critical importance in these patients. Also, when treating a patient with a cardiac condition associated with an increased risk for IE, the dentist should remain alert to the presence of signs or symptoms of IE (e.g., fever) and make the appropriate physician referral as indicated. This precaution applies whether or not the patient has received prophylactic antibiotics for dental procedures.

Special Situations²⁵

Patients Already Taking Antibiotics. In patients who are already taking penicillin or amoxicillin for eradication of an infection (e.g., sinus infection) or for long-term secondary prevention of rheumatic fever, presence of viridans group streptococci that are relatively resistant to penicillin or amoxicillin is likely. Therefore, clindamycin, azithromycin, or clarithromycin should be selected for prophylaxis if treatment is immediately necessary. Because of cross-resistance with cephalosporins, this class of antibiotics should be avoided. An alternative approach is to wait for at least 10 days after completion of antibiotic therapy before administration of prophylactic antibiotics. In this instance, the usual regimen can be used.

Patients Undergoing Cardiac Surgery. It is recommended that a preoperative dental evaluation be performed and necessary dental treatment be provided whenever possible before initiation of cardiac valve surgery or replacement or repair of congenital heart disease in an effort to decrease the incidence of late PVE caused by viridans group streptococci.

Prolonged Dental Appointment. The duration of a dental appointment in relation to the effective plasma concentration of an administered antibiotic is not addressed in

these recommendations; however, for a lengthy appointment, this may be a matter of concern. With amoxicillin, which has a half-life of approximately 80 minutes, the average peak plasma concentration of 4 µg/mL is reached about 2 hours after oral administration of a 250-mg dose.⁹⁰ Most of the penicillin-sensitive viridans group streptococci have an MIC requirement of 0.2 µg/mL.²⁰ Thus, a 2-g dose of amoxicillin should produce an acceptable MIC for at least 6 hours. If a procedure lasts longer than 6 hours, it may be prudent to administer an additional 2-g dose.

Other Considerations²⁵

Based on current evidence, coronary artery bypass graft surgery is not associated with long-term risk for infection; thus, antibiotic prophylaxis is not recommended for patients undergoing this procedure. Patients who have had a heart transplant are at increased risk for acquired valvular dysfunction, especially during episodes of rejection. Endocarditis that occurs in this instance is associated with a high risk of adverse outcome; therefore, IE prophylaxis may be reasonable in these patients, although its usefulness has not been established. Patients with mechanical or tissue prosthetic valves often will be taking long-term anticoagulant medication (e.g., warfarin) to prevent valve-associated thrombosis. These patients are at risk for excessive bleeding during and after surgical procedures (see [Chapter 24](#)).

Implementation of the Recommendations

In view of the significant changes that have been made since previous AHA recommendations for antibiotic prophylaxis were published, patients may have questions and may be concerned about the implementation of the current recommendations. Patients with various valvular

disorders (e.g., MVP, rheumatic heart disease) who have been told for many years that they needed antibiotics because of the risk for IE caused by dental treatment are now informed that they no longer require antibiotics when they go to the dentist. Additionally, patients who were previously told that they required antibiotic prophylaxis only for invasive dental procedures (i.e., only patients with conditions listed in [Box 2.1](#)) are now told that antibiotic prophylaxis is recommended for essentially all dental treatment. The AHA recommends discussing the reasons for the revision with the patient in an effort to alleviate concern. The *Journal of the American Dental Association* in its July 2007 issue includes a letter explaining the rationale for the changes, which can be copied for use as a patient handout.

A reasonable approach is to share the 2007 AHA recommendations with the patient and explain the rationale for changes, emphasizing that they are based on an extensive review of current scientific evidence. In addition, the dentist should consult with the patient's physician to ensure that he or she is aware of the current AHA recommendations and to discuss their implementation in treatment of the patient. These conversations should be documented in the patient's progress notes.

Nonvalvular Cardiovascular Devices

In a 2003 AHA scientific statement,⁹¹ guidelines are provided regarding antibiotic prophylaxis for patients with various types of nonvalvular cardiovascular devices (e.g., coronary artery stents, hemodialysis grafts) who are undergoing dental procedures. [Table 2.7](#) provides a list of various devices along with their reported incidences of infection. After performing an extensive review of available data, the AHA reporting committee concluded that no convincing evidence suggests that microorganisms associated with dental procedures cause infection of nonvalvular vascular devices at any time after implantation. Indeed, infections of these devices most often are caused by staphylococci, gram-negative bacteria, or other microorganisms associated with implantation of the device or resulting from wound or other active infections. Accordingly, the AHA does not recommend routine antibiotic prophylaxis for patients with any of these devices who undergo dental procedures. Prophylaxis is recommended, however, for selected patients with these devices:

- Patients undergoing incision and drainage of infected tissue (abscesses)
- Patients with residual valve leak after device placement for attempted closure of leaks associated with patent ductus arteriosus, atrial septal defect, or ventricular septal defect

Intravascular Catheters

Concerns often arise regarding the need for antibiotic prophylaxis to prevent infection in patients with various types of IV or intraarterial catheters. Examples are

TABLE 2.7 Nonvalvular Cardiovascular Device–Related Infections

Type of Device	Incidence of Infection (%)
INTRACARDIAC	
Pacemakers (temporary and permanent)	0.13–19.9
Defibrillators	0.00–3.2
Left ventricular assist devices	25–70
Total artificial hearts	To be determined
Ventriculoatrial shunts	2.4–9.4
Pledgets	Rare
Patent ductus arteriosus occlusion devices	Rare
Atrial septal defect and ventriculoseptal defect occlusion devices	Rare
Conduits	Rare
Patches	Rare
ARTERIAL	
Peripheral vascular stents	Rare
Vascular grafts, including for hemodialysis	1.0–6
Intraaortic balloon pumps	≤5–26
Angioplasty or angiography	<1
Coronary artery stents	Rare
Patches	1.8
VENOUS	
Vena cava filters	Rare

From Baddour LM, et al: Nonvalvular cardiovascular device–related infections, *Circulation* 108:2015–2031, 2003.

peripheral venous catheters, peripheral arterial catheters, midline catheters, nontunneled central venous catheters, pulmonary artery catheters, peripherally inserted central venous catheters (PICCs), tunneled central venous catheters, totally implantable catheters, and umbilical catheters ([Table 2.8](#)). The causative microorganisms in these infections include coagulase-negative staphylococci, *S. aureus*, enterococci, gram-negative rods, *Escherichia coli*, *Enterobacter* and *Candida* spp., *P. aeruginosa*, and *Klebsiella pneumoniae*. None of these, with the exception of *Candida*, are normal inhabitants of the oral cavity; thus, they do not introduce risk for infection with oral procedures. The Centers for Disease Control and Prevention, in its published Guidelines for the Prevention of Intravascular Catheter-Related Infections,⁹² does not include any recommendation for antibiotic prophylaxis for patients with any of these devices who are undergoing dental procedures. Likewise, a review found no evidence to support the administration of prophylactic antibiotics to prevent catheter-related infections associated with an invasive dental procedure in patients with chronic indwelling central venous catheters.⁹³

The practice of providing antibiotics for dental patients with various types of medical problems (other than for endocarditis prophylaxis) to prevent metastatic infection

TABLE 2.8 Catheters Used for Venous and Arterial Access

Catheter Type	Entry Site	Comments
Peripheral venous catheters (short)	Usually inserted into veins of forearm or hand	Phlebitis with prolonged use; rarely associated with bloodstream infection
Peripheral arterial catheters	Usually inserted into radial artery; can be placed in femoral, axillary, brachial, or posterior tibial arteries	Low infection risk; rarely associated with bloodstream infection
Midline catheters	Inserted through antecubital fossa into proximal basilica or cephalic veins; does not enter central veins or peripheral catheters	Anaphylactoid reactions have been reported with catheters made of elastomeric hydrogel; lower rates of phlebitis than with short peripheral catheters
Nontunneled central venous catheters	Percutaneously inserted into central veins (subclavian, internal jugular, or femoral)	Account for most catheter-related bloodstream infections
Pulmonary artery catheters	Inserted through a Teflon introducer into a central vein (subclavian, internal jugular, or femoral)	Usually heparin bonded; similar rates of bloodstream infection as central venous catheters
Peripherally inserted central venous catheters	Inserted into basilica, cephalic, or brachial veins and advanced to superior vena cava	Lower rate of infection than nontunneled central venous catheters
Tunneled central venous catheters	Implanted into subclavian, internal jugular, or femoral veins	Cuff inhibits migration of organisms into catheter tract; lower rate of infection than with nontunneled central venous catheters
Totally implantable	Tunneled beneath skin with subcutaneous port access with a needle; implanted in subclavian or internal jugular vein	Lowest risk for catheter-related bloodstream infections; improved patient self-image; no need for local catheter site care; surgery required for catheter removal
Umbilical catheters	Inserted into umbilical vein or umbilical artery	Risk for catheter-related bloodstream infection similar with use of umbilical vein and with use of artery

Adapted from O'Grady NP, et al: Guidelines for the prevention of intravascular catheter-related infections. Centers for Disease Control and Prevention, *MMWR Recomm Rep* 51:1-29, 2002.

BOX 2.3 Other Conditions, Unrelated to Endocarditis Prophylaxis, for Which Antibiotic Prophylaxis Has Been Advocated, but Without Evidence for Need or Efficacy

Organ transplants
 Prosthetic joints
 Cerebrospinal fluid shunts
 Immunosuppressive drugs (e.g., steroids, DMARDs, chemotherapy)
 Autoimmune disease (e.g., SLE)
 Insulin-dependent
 HIV infection/AIDS
 Splenectomy
 Severe neutropenia
 Sickle cell anemia
 Breast implants
 Penile implants

AIDS, Acquired immunodeficiency syndrome; DMARD, disease-modifying antirheumatic drugs HIV, human immunodeficiency virus; SLE, systemic lupus erythematosus.

from oral flora is controversial. In almost every instance, no evidence of need or efficacy has been documented.^{94,95} Box 2.3 lists several of those conditions for which antibiotics have been advocated.

REFERENCES

1. Karchmer AW. Infective endocarditis. In: Libby P, ed. *Braunwald's Heart Disease: A Textbook of Cardiovascular Medicine*. 8th ed. Philadelphia: Saunders; 2008:1713-1738.
2. Ferri FF. Infective endocarditis. In: Ferri FF, ed. *Ferri's Clinical Advisor*. 2015 ed. Philadelphia, PA: Elsevier (Saunders); 2015:25.
3. Cahill TJ, Prendergast BD. Infective endocarditis. *Lancet*. 2016;387(10021):882-893.
4. Fowler VGJ, Bayer AS, Baddour LM. Infective endocarditis. In: Goldman L, Schafer AI, eds. *Goldman-Cecil Medicine*. 25th ed. Philadelphia, PA: Elsevier (Saunders); 2016:30.
5. Klein M, Wang A. Infective endocarditis. *J Intensive Care Med*. 2016;31(3):151-163.
6. Shrestha NK, Jue J, Hussain ST, et al. Injection Drug Use and outcomes after surgical intervention for infective

- endocarditis. *Ann Thorac Surg.* 2015;100(3):875-882.
7. Bashore TM, Cabell C, Fowler V Jr. Update on infective endocarditis. *Curr Probl Cardiol.* 2006;31(4):274-352.
 8. Fowler VG Jr, Bayer A. Infective endocarditis. In: Goldman L, Ausiello D, eds. *Cecil Medicine.* 23rd ed. Philadelphia: Saunders; 2008:537-548.
 9. Berlin JA, Abrutyn E, Strom BL, et al. Incidence of infective endocarditis in the Delaware Valley, 1988-1990. *Am J Cardiol.* 1995;76(12):933-936.
 10. Tleyjeh IM, Steckelberg JM, Murad HS, et al. Temporal trends in infective endocarditis: a population-based study in Olmsted County, Minnesota. *JAMA.* 2005;293(24):3022-3028.
 11. Steckelberg JM, Wilson WR. Risk factors for infective endocarditis. *Infect Dis Clin North Am.* 1993;7(1):9-19.
 12. de Sa D. Epidemiological trends of infective endocarditis: a population-based study in Olmsted County. *Mayo Clin Proc.* 2010;85:422-426.
 13. O'Brien MC, Pourmoghadam KK, DeCampi WM. Late postoperative prosthetic pulmonary valve endocarditis in a 13-year-old girl with repaired tetralogy of Fallot. *Tex Heart Inst J.* 2015;42(3):251-254.
 14. Miranda WR, Connolly HM, DeSimone DC, et al. Infective endocarditis involving the pulmonary valve. *Am J Cardiol.* 2015;116(12):1928-1931.
 15. Mylanakis E, Calderwood SB. Infective endocarditis in adults. *N Engl J Med.* 2001;345(18):1318-1330.
 16. Miro JM, del Rio A, Mestres CA. Infective endocarditis in intravenous drug abusers and HIV-1 infected patients. *Infect Dis Clin North Am.* 2002;16(2):273-295, vii-viii.
 17. Otome O, Guy S, Tramontana A, et al. A retrospective review: significance of vegetation size in injection drug users with right-sided infective endocarditis. *Heart Lung Circ.* 2016;25(5):466-470.
 18. Schoenfeld M, Machhar R, Maw A. Diagnosing endocarditis in patients with *Staphylococcus aureus* bacteremia. *JAMA.* 2015;313(4):420.
 19. Mathew J, Addai T, Anand A, et al. Clinical features, site of involvement, bacteriologic findings, and outcome of infective endocarditis in intravenous drug users. *Arch Intern Med.* 1995;155(15):1641-1648.
 20. Baddour LM, Wilson WR, Bayer AS, et al. Infective endocarditis: diagnosis, antimicrobial therapy, and management of complications: a statement for healthcare professionals from the Committee on Rheumatic Fever, Endocarditis, and Kawasaki Disease, Council on Cardiovascular Disease in the Young, and the Councils on Clinical Cardiology, Stroke, and Cardiovascular Surgery and Anesthesia, American Heart Association: endorsed by the Infectious Diseases Society of America. *Circulation.* 2005;111(23):e394-e434.
 21. Baddour LM, Bettmann MA, Bolger AF, et al. Nonvalvular cardiovascular device-related infections. *Clin Infect Dis.* 2004;38(8):1128-1130.
 22. Revest M, Egmann G, Cattoir V, et al. HACEK endocarditis: state-of-the-art. *Expert Rev Anti Infect Ther.* 2016;14(5):523-530.
 23. Sharara SL, Tayyar R, Kanafani ZA, et al. HACEK endocarditis: a review. *Expert Rev Anti Infect Ther.* 2016;1-7.
 24. Majumdar A, Chowdhary S, Ferreira MA, et al. Renal pathological findings in infective endocarditis. *Nephrol Dial Transplant.* 2000;15(11):1782-1787.
 25. Wilson W, Taubert KA, Gewitz M, et al. Prevention of infective endocarditis. Guidelines From the American Heart Association. A guideline From the American Heart Association Rheumatic Fever, Endocarditis, and Kawasaki Disease Committee, Council on Cardiovascular Disease in the Young, and the Council on Clinical Cardiology, Council on Cardiovascular Surgery and Anesthesia, and the Quality of Care and Outcomes Research Interdisciplinary Working Group. *Circulation.* 2007;115:1-17.
 26. Hoen B, Selton-Suty C, Lacassin F, et al. Infective endocarditis in patients with negative blood cultures: analysis of 88 cases from a one-year nationwide survey in France. *Clin Infect Dis.* 1995;20(3):501-506.
 27. Li JS, Sexton DJ, Mick N, et al. Proposed modifications to the Duke criteria for the diagnosis of infective endocarditis. *Clin Infect Dis.* 2000;30(4):633-638.
 28. Durack DT, Lukes AS, Bright DK. New criteria for diagnosis of infective endocarditis: utilization of specific echocardiographic findings. Duke Endocarditis Service [see comments]. *Am J Med.* 1994;96(3):200-209.
 29. Topan A, Carstina D, Slavcovi A, et al. Assessment of the Duke criteria for the diagnosis of infective endocarditis after twenty-years. An analysis of 241 cases. *Chujul Med.* 2015;88(3):321-326.
 30. Wallace SM, Walton BI, Kharbanda RK, et al. Mortality from infective endocarditis: clinical predictors of outcome. *Heart.* 2002;88(1):53-60.
 31. Marti-Carvajal AJ, Dayer M, Conterno LO, et al. A comparison of different antibiotic regimens for the treatment of infective endocarditis. *Cochrane Database Syst Rev.* 2016;(4):CD009880.
 32. Pericart L, Fauchier L, Bourguignon T, et al. Long-term outcome and valve surgery for infective endocarditis in the systematic analysis of a community study. *Ann Thorac Surg.* 2016.
 33. Yong MS, Coffey S, Prendergast BD, et al. Surgical management of tricuspid valve endocarditis in the current era: a review. *Int J Cardiol.* 2016;202:44-48.
 34. Kang DH. Timing of surgery in infective endocarditis. *Heart.* 2015;101(22):1786-1791.
 35. Pang PY, Sin YK, Lim CH, et al. Surgical management of infective endocarditis: an analysis of early and late outcomes. *Eur J Cardiothorac Surg.* 2015;47(5):826-832.
 36. Osterdal OB, Salminen PR, Jordal S, et al. Cardiac surgery for infective endocarditis in patients with intravenous drug use. *Interact Cardiovasc Thorac Surg.* 2016;22(5):633-640.
 37. AHA. Prevention of rheumatic fever and bacterial endocarditis through control of streptococcal infections. *Circulation.* 1955;11:317-320.
 38. Jones T. Prevention of rheumatic fever and bacterial endocarditis through control of streptococcal infections. *Circulation.* 1955;11:317-320.
 39. Rammelkamp CH, Catanzaro FJ, Chamovitz R, American Heart Association. Treatment of streptococcal infections in the general population. *Circulation.* 1957;15:154-158.

40. AHA. Prevention of rheumatic fever and bacterial endocarditis through control of streptococcal infection. *Circulation*. 1965;31:953-955.
41. Hussar AE. Prevention of bacterial endocarditis. *Circulation*. 1965;31:953-954.
42. Kaplan EL. Prevention of bacterial endocarditis. *Circulation*. 1977;56(1):139A-143A.
43. Shulman ST, Amren DP, Bisno AL, et al. Prevention of Bacterial Endocarditis. A statement for health professionals by the Committee on Rheumatic Fever and Infective Endocarditis of the Council on Cardiovascular Disease in the Young. *Circulation*. 1984;70(6):1123A-1127A.
44. Dajani AS, Bisno AL, Chung KJ, et al. Prevention of bacterial endocarditis. Recommendations by the American Heart Association. *JAMA*. 1990;264(22):2919-2922.
45. Dajani AS, Taubert KA, Wilson W, et al. Prevention of bacterial endocarditis: recommendations by the American Heart Association. *JAMA*. 1997;22(June 11):1794-1801.
46. Dajani AS, Taubert KA, Wilson W, et al. Prevention of bacterial endocarditis: recommendations by the American Heart Association. *J Am Dent Assoc*. 1997;128(8):1142-1151.
47. Pallasch TJ, Slots J. Antibiotic prophylaxis and the medically compromised patient. *Periodontol 2000*. Denmark: Munksgaard; 1996;107-138.
48. Lockhart PB, Durack DT. Oral microflora as a cause of endocarditis and other distant site infections. *Infect Dis Clin North Am*. 1999;13(4):833-850, vi.
49. Lockhart PB. The risk for endocarditis in dental practice. *Periodontol 2000*. 2000;23:127-135.
50. Roberts GJ, Jaffray EC, Spratt DA, et al. Duration, prevalence and intensity of bacteraemia after dental extractions in children. *Heart*. 2006;92(9):1274-1277.
51. Round H, Kirkpatrick H, Hails C. Further investigations on bacteriological infections of the mouth. *Proc R Soc Med*. 1936;29:1552-1556.
52. Cobe HM. Transitory bacteremia. *Oral Surg Oral Med Oral Pathol*. 1954;7(6):609-615.
53. Rise E, Smith JF, Bell J. Reduction of bacteremia after oral manipulations. *Arch Otolaryngol*. 1969;90:106-109.
54. O'Leary TJ, Shafer WG, Swenson HM, et al. Possible penetration of crevicular tissue from oral hygiene procedures. II. Use of the toothbrush. *J Periodontol*. 1970;41(3):163-164.
55. O'Leary TJ, Shafer WG, Swenson HM, et al. Possible penetration of crevicular tissue from oral hygiene procedures. I. Use of oral irrigating devices. *J Periodontol*. 1970;41(3):158-162.
56. Felix JE, Rosen S, App GR. Detection of bacteremia after the use of an oral irrigation device in subjects with periodontitis. *J Periodontol*. 1971;42(12):785-787.
57. Sconyers JR, Crawford JJ, Moriarty JD. Relationship of bacteremia to toothbrushing in patients with periodontitis. *J Am Dent Assoc*. 1973;87(3):616-622.
58. Faden HS. Letter: dental procedures and bacteremia. *Ann Intern Med*. 1974;81(2):274.
59. Schlein RA, Kudlick EM, Reindorf CA, et al. Toothbrushing and transient bacteremia in patients undergoing orthodontic treatment. *Am J Orthod Dentofacial Orthop*. 1991;99(5):466-472.
60. Crasta K, Daly CG, Mitchell D, et al. Bacteraemia due to dental flossing. *J Clin Periodontol*. 2009;36(4):323-332.
61. Guntheroth WG. How important are dental procedures as a cause of infective endocarditis? *Am J Cardiol*. 1984;54:797-801.
62. Roberts GJ. Dentists are innocent! "Everyday" bacteremia is the real culprit: a review and assessment of the evidence that dental surgical procedures are a principal cause of bacterial endocarditis in children. *Pediatr Cardiol*. 1999;20(5):317-325.
63. Durack DT, Beeson PB. Experimental bacterial endocarditis. II. Survival of a bacteria in endocardial vegetations. *Br J Exp Pathol*. 1972;53(1):50-53.
64. Lucas VS, Lytra V, Hassan T, et al. Comparison of lysis filtration and an automated blood culture system (BACTEC) for detection, quantification, and identification of odontogenic bacteremia in children. *J Clin Microbiol*. 2002;40(9):3416-3420.
65. Lockhart PB, Brennan MT, Thornhill M, et al. Poor oral hygiene is a risk factor for infective endocarditis-related bacteremia. *J Am Dent Assoc*. 2009;140(Oct):1238-1244.
66. Asi KS, Gill AS, Mahajan S. Postoperative bacteremia in periodontal flap surgery, with and without prophylactic antibiotic administration: a comparative study. *J Indian Soc Periodontol*. 2010;14(1):18-22.
67. Durack DT. Prevention of infective endocarditis. *N Engl J Med*. 1995;332(1):38-44.
68. Durack DT. Antibiotics for prevention of endocarditis during dentistry: time to scale back? *Ann Intern Med*. 1998;129(10):829-830.
69. Strom BL, Abrutyn E, Berlin JA, et al. Dental and cardiac risk factors for infective endocarditis: a population-based, case-control study. *Ann Intern Med*. 1998;129(10):761-769.
70. Brennan MT, Kent ML, Fox PC, et al. The impact of oral disease and nonsurgical treatment on bacteremia in children. *J Am Dent Assoc*. 2007;138(1):80-85.
71. Mougeot FK, Saunders SE, Brennan MT, et al. Associations between bacteremia from oral sources and distant-site infections: tooth brushing versus single tooth extraction. *Oral Surg Oral Med Oral Pathol Oral Radiol*. 2015;119(4):430-435.
72. Ferri FF. Infective endocarditis. In: Ferri FF, ed. *Ferri's Clinical Advisor*. 2015 ed. Philadelphia, PA: Elsevier (Saunders); 2015:25.
73. van der Meer JT, Thompson J, Valkenburg HA, et al. Epidemiology of bacterial endocarditis in the Netherlands. II. Antecedent procedures and use of prophylaxis. *Arch Intern Med*. 1992;152(9):1869-1873.
74. Hall G, Hedstrom SA, Heimdahl A, et al. Prophylactic administration of penicillins for endocarditis does not reduce the incidence of postextraction bacteremia. *Clin Infect Dis*. 1993;17(2):188-194.
75. Hall G, Heimdahl A, Nord CE. Effects of prophylactic administration of cefaclor on transient bacteremia after dental extraction. *Eur J Clin Microbiol Infect Dis*. 1996;15(8):646-649.

76. Lockhart PB. An analysis of bacteremias during dental extractions: a double-blind, placebo-controlled study of chlorhexidine. *Arch Intern Med.* 1996;156:513-520.
77. Hall G, Heimdahl A, Nord CE. Bacteremia after oral surgery and antibiotic prophylaxis for endocarditis. *Clin Infect Dis.* 1999;29(1):1-8, quiz 9-10.
78. van der Meer JT, Van Wijk W, Thompson J, et al. Efficacy of antibiotic prophylaxis for prevention of native-valve endocarditis. *Lancet.* 1992;339(8786):135-139.
79. Oliver R, Roberts GJ, Hooper L, et al. Antibiotics for the prophylaxis of bacterial endocarditis in dentistry. *Cochrane Database Syst Rev.* 2008;(4):CD003813.
80. Gould FK, Elliott TS, Foweraker J, et al. Guidelines for the prevention of endocarditis: report of the Working Party of the British Society for Antimicrobial Chemotherapy. *J Antimicrob Chemother.* 2006;57(6):1035-1042.
81. Danchin N, Duval X, Leport C. Prophylaxis of infective endocarditis: French recommendations 2002. *Heart.* 2005;91(6):715-718.
82. Richey R, Wray D, Stokes T. Prophylaxis against infective endocarditis: summary of NICE guidance. *BMJ.* 2008;336(7647):770-771.
83. Thornhill MH. Infective endocarditis: the impact of the NICE guidelines for antibiotic prophylaxis. *Dent Update.* 2012;39(1):6-10, 12.
84. Dayer MJ, Chambers JB, Prendergast B, et al. NICE guidance on antibiotic prophylaxis to prevent infective endocarditis: a survey of clinicians' attitudes. *QJM.* 2013;106(3):237-243.
85. Lockhart PB, Bahrani Mougeot FK, Saunders SE, et al. The effectiveness of antibiotic prophylaxis in preventing infective endocarditis is not easily dismissed. *Oral Surg Oral Med Oral Pathol Oral Radiol.* 2015;120(5):661-662.
86. Thornhill MH, Lockhart PB, Prendergast B, et al. NICE and antibiotic prophylaxis to prevent endocarditis. *Br Dent J.* 2015;218(11):619-621.
87. Thompson W, Sandoe JA. What does NICE have to say about antimicrobial prescribing to the dental community? *Br Dent J.* 2016;220(4):193-195.
88. Thornhill MH, Dayer M, Lockhart PB, et al. Guidelines on prophylaxis to prevent infective endocarditis. *Br Dent J.* 2016;220(2):51-56.
89. Beck DL, Braunwald E. AHA 2015: increased incidence of infective endocarditis after the 2009 ESC guideline update: a nationwide study in the Netherlands. In: Goldman L, Schafer AI, eds. *Braunwald's Heart Disease: A Textbook of Cardiovascular Medicine.* Philadelphia, PA: Elsevier (Saunders); 2016:20.
90. Petri W. Penicillins, cephalosporins, and other b-lactam antibiotics. In: Brunton L, Lazo J, Parker K, eds. *Goodman and Gilman's The Pharmacological Basis of Therapeutics.* 11th ed. New York: McGraw-Hill; 2006:1127-1154.
91. Baddour LM, Bettmann MA, Bolger AF, et al. Nonvalvular cardiovascular device-related infections. *Circulation.* 2003;108(16):2015-2031.
92. O'Grady NP, Alexander M, Dellinger EP, et al. Guidelines for the prevention of intravascular catheter-related infections. Centers for Disease Control and Prevention. *MMWR Recomm Rep.* 2002;51(RR-10):1-29.
93. Hong CH, Allred R, Napenas JJ, et al. Antibiotic prophylaxis for dental procedures to prevent indwelling venous catheter-related infections. *Am J Med.* 2010;123(12):1128-1133.
94. Lockhart PB, Loven B, Brennan MT, et al. The evidence base for the efficacy of antibiotic prophylaxis in dental practice. *J Am Dent Assoc.* 2007;138(4):458-475.
95. Little JW, Falace DA, Miller DS, et al. Antibiotic prophylaxis: an update for dentistry. *Gen Dent.* 2008;56(1):20-29.

Hypertension

Hypertension is an abnormal elevation in arterial pressure that can be fatal if sustained and untreated. People with hypertension may not display clinical signs or symptoms for many years but eventually can experience symptomatic damage to several target organs, including the kidneys, heart, brain, and eyes. In adults, a sustained systolic blood pressure (BP) of 140 mm Hg or greater or a sustained diastolic blood pressure of 90 mm Hg or greater is defined as hypertension. The Seventh Report of the Joint National Committee on Prevention, Detection, Evaluation, and Treatment of High Blood Pressure (JNC 7) report published in 2003¹ classifies BP in four stages: normal, prehypertension, stage 1, and stage 2 (Table 3.1). These stages reflect the health risks associated with BPs higher than 115/75 mm Hg and help establish thresholds for treatment and allow for monitoring treatment effectiveness, the latter being important for decreasing the frequency of adverse vascular outcomes associated with chronic high BP such as stroke and myocardial infarction (MI). In contrast, JNC 8 (published in 2014) focuses on evidence-based recommendations for treatment (drug selection) and treatment goals. Together these two documents (JNC 7 and JNC 8) help establish the recommendations for follow-up care of patients based on initial BP measurements (see Table 3.1). A separate publication provides similar information on the classification, detection, diagnosis, and management of hypertension in children and adolescents.² In children and adolescents, hypertension is defined as elevated BP that persists on repeated measurement at the 95th percentile or greater for age, height, and gender (Tables 3.2 and 3.3). For example, Table 3.3 illustrates that a 6-year-old girl who is at the 50th percentile in height is considered to have hypertension if her BP is persistently 111/74 mm Hg or greater.

Although only a physician can make the diagnosis of hypertension and decide on its treatment, the JNC guidelines specifically encourage the active participation of all health care professionals in the detection of hypertension and the surveillance of treatment compliance.¹ Accordingly, dental health professionals can play a significant role in the detection and control of hypertension and may be the first to detect a patient with an elevation in BP or with symptoms of hypertensive disease. Along with detection, monitoring is an equally valuable service because patients who are receiving treatment for hypertension may nevertheless fail to achieve adequate control

because of poor compliance or inappropriate drug selection or dosing. An abnormal BP reading in the dental office becomes the basis for referral to, or consultation with, a physician. In addition, hypertension poses several considerations with respect to dental management, including monitoring BP during appointments, stress and anxiety reduction, prevention of drug interactions, and awareness and management of adverse drug side effects.

EPIDEMIOLOGY

Hypertension is the most common primary diagnosis in the United States, accounting for 39 million office visits annually.³ Before 1990, the prevalence of hypertension was steadily declining; however, recent evidence indicates that the trend has reversed, and hypertension is again on the rise.⁴ According to National Health and Nutrition Examination Survey (NHANES) data for the period 2011 to 2012, at least 75 million adults in the United States have high blood pressure (HBP) or are taking antihypertensive medication.⁴ This estimate equals about 29% of the U.S. population compared with 24% when surveyed between 1988 to 1991.⁵ This marked increase is attributed to aging of the population and the epidemic increase in obesity. Accordingly, a typical practice population of 2000 patients will have about 580 patients who have hypertension.

The prevalence of hypertension is similar among men and women but varies with race and ethnicity. The highest prevalence is among non-Hispanic blacks (42%) followed by non-Hispanic whites (28%), Hispanics (26%), and non-Hispanic Asians (25%).⁴ Racial and ethnic disparities in prevalence are largely driven by differences in socioeconomic status, environmental influences, and personal behavior and habits.

The prevalence increases with aging, such that more than 65% of Americans aged 60 years and older have hypertension.⁴ If people live long enough, more than 90% will develop hypertension.⁶ Of note, systolic BP continues to rise throughout life, but diastolic BP rises until around age 50 years and then levels off or falls; as a result, after the age of 50, isolated systolic hypertension becomes the more prevalent pattern. In one study, isolated systolic hypertension was identified in 87% of inadequately controlled patients older than 60 years of age.⁷ Isolated diastolic hypertension most commonly is seen before age

TABLE 3.1 Classification of Blood Pressure (BP) in Adults and Recommendations for Follow-Up

BP Classification	Systolic BP (mm Hg)		Diastolic BP (mm Hg)	Recommended Follow-Up
Normal	<120	and	<80	Recheck in 2 years.
Prehypertension	120–139	or	80–89	Recheck in 1 year.
Stage 1 hypertension	140–159	or	90–99	Confirm within 2 months.
Stage 2 hypertension	≥160	or	≥100	Evaluate or refer to source of care within 1 month. For those with higher BP (e.g., >180/110 mm Hg), evaluate and treat immediately or within 1 week, depending on the clinical situation and complications.

Adapted from the National Heart, Lung, and Blood Institute: *The seventh report of the Joint National Committee on Prevention, Detection, Evaluation, and Treatment of High Blood Pressure: the JNC 7 report*, Bethesda, Maryland, US Department of Health and Human Services, Public Health Service, Bethesda, MD, National Institutes of Health, National Heart, Lung, and Blood Institute, August 2004.

TABLE 3.2 Classification of Blood Pressure in Children and Adolescents

Classification	SBP or DBP Percentile*
Normal	<90th
Prehypertension	90th to <95th, or pressure exceeds 120/80 mm Hg even with <90th percentile up to <95th percentile
Stage 1 hypertension	95th to 99th percentile plus 5 mm Hg
Stage 2 hypertension	>99th percentile plus 5 mm Hg

DBP, Diastolic blood pressure; SBP, systolic blood pressure.

*For gender, age, and height, as measured on at least three separate occasions.

Data from the National Heart, Lung, and Blood Institute: *The Fourth Report on the Diagnosis, Evaluation, and Treatment of High Blood Pressure in Children and Adolescents*, Bethesda, MD, US Department of Health and Human Services, Public Health Service, National Institutes of Health, National Heart, Lung, and Blood Institute, May 2005.

50 years. Diastolic BP is a more potent cardiovascular risk factor than is systolic BP until age 50; thereafter, systolic BP is more important.⁸

Awareness of hypertension is important. For this reason, the National High Blood Pressure Education Program was begun in 1972, and its successes are obvious.⁴ The number of people with HBP who are aware of their condition has increased over the decades from 51% to 82%, and the percentage of those receiving treatment for HBP has increased from 31% to 76%. The proportion of patients taking medication whose BP is controlled to 140/90 mm Hg has increased from 10% to 52%.⁴ Concomitant with increased awareness and treatment has been a significant decline in number of deaths from coronary heart disease (50%) and from stroke (57%), although this decline has slowed in recent years. Although these trends are encouraging, 18% of patients with HBP remain unaware of their disease, 24% of patients with HBP are not being treated, and 48% of hypertensive patients are taking medications but not achieving adequate control of the condition.⁴

ETIOLOGY

About 90% of patients have no readily identifiable cause for their disease, which is referred to as primary (essential) hypertension. In the remaining 10% of patients, an underlying cause or condition may be identified; for these patients, the term *secondary hypertension* is applied. **Box 3.1** is a listing of the most common identifiable causes of secondary hypertension. Lifestyle factors (obesity, excessive alcohol intake, excessive dietary sodium and physical inactivity) contribute significantly to the presence, severity and progression of hypertension.

BOX 3.1 Identifiable Causes of Hypertension

- Chronic kidney disease (e.g., diabetic nephropathy)
- Chronic steroid therapy and Cushing syndrome
- Coarctation of the aorta
- Drug induced or drug related
- Pheochromocytoma
- Primary hyperaldosteronism
- Renovascular disease
- Sleep apnea
- Thyroid or parathyroid disease

Data from the National Heart, Lung, and Blood Institute: *The seventh report of the Joint National Committee on Prevention, Detection, Evaluation, and Treatment of High Blood Pressure: the JNC 7 report*, Bethesda, MD, U.S. Department of Health and Human Services, Public Health Service, National Institutes of Health, National Heart, Lung, and Blood Institute, August 2004.

PATHOPHYSIOLOGY AND COMPLICATIONS

In primary hypertension, the basic underlying defect is a failure in the regulation of vascular resistance. The pulsating force is modified by the degree of elasticity of the walls of larger arteries and the resistance of the arteriolar bed. Control of vascular resistance is multifactorial, and abnormalities may exist in one or more areas. Mechanisms

TABLE 3.3 95th Percentile of Blood Pressure by Selected Ages, by 50th and 75th Height Percentiles, and by Gender in Children and Adolescents

Age (yr)	GIRLS' SBP/DBP (mm Hg)		BOYS' SBP/DBP (mm Hg)	
	50th Percentile for Height	75th Percentile for Height	50th Percentile for Height	75th Percentile for Height
1	104/58	105/59	103/56	104/57
6	111/74	113/74	114/74	115/75
12	123/80	124/81	123/81	125/82
17	129/84	130/85	136/87	138/87

DBP, Diastolic blood pressure; SBP, systolic blood pressure.

Data from the National Heart, Lung, and Blood Institute: *The Fourth Report on the Diagnosis, Evaluation, and Treatment of High Blood Pressure in Children and Adolescents*, Bethesda, Maryland, US Department of Health and Human Services, Public Health Service, Bethesda, MD, National Institutes of Health, National Heart, Lung, and Blood Institute, May 2005.

of control include neural baroreflexes and ongoing maintenance of sympathetic vasomotor tone and other effects mediated by neurotransmitters such as norepinephrine, extracellular fluid, and sodium stores; the renin–angiotensin–aldosterone pressor system; and locally active hormones and substances such as prostaglandins, kinins, adenosine, and hydrogen ions (H⁺). In our modern cultures, high salt intake appears to trigger neuromodulatory signals that activate the sympathetic nervous system, resulting in increased renin secretion by the kidneys.⁹ In isolated systolic hypertension, which commonly is seen in older adults, the underlying problem is one of central arterial stiffness and loss of elasticity.⁶

Several physiologic factors may have an effect on BP. Increased viscosity of the blood (e.g., polycythemia) may cause an elevation in BP resulting from an increase in resistance to flow. A decrease in blood volume or tissue fluid volume (e.g., anemia, hemorrhage) reduces BP. Conversely, an increase in blood volume or tissue fluid volume (e.g., sodium and fluid retention) increases BP. Increases in cardiac output associated with exercise, fever, or thyrotoxicosis can increase BP. In addition, BP demonstrates a circadian variation with highest levels seen in early to mid-morning, lower levels as the day progresses, and the lowest BP at night.

A linear relationship exists between BPs at any level above normal and an increase in morbidity and mortality rates from stroke and coronary heart disease. BPs above 115 mm Hg systolic and 75 mm Hg diastolic are associated with increased risk of cardiovascular disease.¹⁰ It is estimated that about 15% of all BP-related deaths from coronary heart disease occur in persons with BP in the prehypertensive range.¹¹ However, the higher the BP, the greater the chances of heart attack, heart failure, stroke, and kidney disease. For every increase in BP of 20 mm Hg systolic and 10 mm Hg diastolic, a doubling of mortality related to ischemic heart disease and stroke occurs.¹ Hypertension precedes the onset of vascular changes in the kidney, heart, brain, and retina that lead to such clinical complications as renal failure, stroke, coronary insufficiency, MI, congestive heart failure, dementia,

encephalopathy, and blindness. If the condition goes untreated, a significant number of persons die prematurely.^{12,13} About 50% of hypertensive patients die of coronary heart disease or congestive heart failure, about 33% of stroke, and about 10% of renal failure.¹⁴

CLINICAL PRESENTATION

Signs and Symptoms

Hypertension may remain an asymptomatic disease for many years, with the only sign being an elevated BP. BP is measured with the use of a sphygmomanometer (Fig. 3.1). Pressure at the peak of ventricular contraction is the systolic pressure. Diastolic pressure represents the total resting resistance in the arterial system after passage of the pulsating force produced by contraction of the left ventricle. The difference between diastolic and systolic pressures is called pulse pressure. Mean arterial pressure is roughly defined as the sum of the diastolic pressure plus one third the pulse pressure. Patients commonly are found to have variability in BP throughout the day and according to their environment. About 20% of patients with untreated stage 1 hypertension have what is called white coat hypertension, which is defined as consistently elevated BP only in the presence of a health care worker but not elsewhere.⁶ In these patients, accurate BP readings may require self-measurement at home or 24-hour ambulatory monitoring. Persons with BP elevation in this setting are at lower risk for hypertensive complications than are those with sustained hypertension.

Before the age of 50 years, hypertension typically is characterized by an elevation in both diastolic and systolic pressures. Isolated diastolic hypertension, defined as a systolic BP of 140 or less and a diastolic BP of 90 or greater, is uncommon and most often is found in younger adults. Although the prognostic significance of this condition remains unclear and controversial, it appears that it may be relatively benign.¹⁵ Isolated systolic hypertension is defined as a systolic pressure of 140 mm Hg or higher and a diastolic BP of 90 mm Hg or less; it generally is found in older patients and constitutes an important risk



FIG 3.1 (A) Standard blood pressure cuff (sphygmomanometer) and stethoscope, (B) and (C) automated blood pressure devices.

BOX 3.2 Signs and Symptoms of Hypertensive Disease

Early

- Elevated blood pressure readings
- Narrowing and sclerosis of retinal arterioles
- Headache
- Dizziness
- Tinnitus

Advanced

- Rupture and hemorrhage of retinal arterioles
- Papilledema
- Left ventricular hypertrophy
- Proteinuria
- Congestive heart failure
- Angina pectoris
- Renal failure
- Dementia
- Encephalopathy

factor for cardiovascular disease. Occasionally, isolated systolic BP elevation is found in older children and young adults, often male. In these age groups, this form of hypertension is due to the combination of rapid growth in height and very elastic arteries, which accentuate the normal amplification of the pressure wave between the aorta and the brachial artery, resulting in high systolic pressure in the brachial artery but normal systolic pressure in the aorta.¹⁶

The earliest sign of hypertension is an elevated BP reading; however, funduscopic examination of the retina may show early changes of hypertension consisting of narrowed arterioles with sclerosis. As indicated earlier, hypertension may remain an asymptomatic disease for many years, but when symptoms do occur, they can include headache, tinnitus, and dizziness. These symptoms are not specific for hypertension and may be experienced just as commonly by normotensive persons.¹⁴

Late signs and symptoms are related to involvement of various target organs, including the kidneys, brain, heart, or eyes (Box 3.2). In advanced cases, blurred vision

caused by retinal vessel hemorrhage, exudate, and papilledema may occur. These eye findings are indicative of accelerated malignant hypertension, a medical emergency that requires immediate intervention. Hypertensive encephalopathy is characterized by headache, irritability, alterations in consciousness, and other signs of central nervous system (CNS) dysfunction. Other findings in advanced cases may include enlargement of the left ventricle with impairment of cardiac function, leading to congestive heart failure. Renal involvement can result in hematuria, proteinuria, and renal failure. Persons with hypertension may report fatigue and coldness in the legs or claudication resulting from the peripheral arterial changes that may occur in advanced hypertension. Patients with hypertension often demonstrate an accelerated cognitive decline with aging.¹⁷ Although these changes may be seen in patients with both primary and secondary hypertension, additional signs or symptoms may be present in secondary hypertension associated with underlying disease.

LABORATORY AND DIAGNOSTIC FINDINGS

Current JNC 7 and 8 guidelines recommend that patients who have sustained hypertension be screened through routine laboratory tests, including 12-lead electrocardiography (ECG), urinalysis, blood glucose, hematocrit, electrolytes, creatinine, calcium, and lipid profile.^{1,18} Results of these tests serve as baseline laboratory values that the physician should obtain before initiating therapy. Additional tests that assess thyroid function and serum aldosterone should be considered if clinical and laboratory findings suggest the presence of an underlying cause for hypertension.

MEDICAL MANAGEMENT

Evaluation of a patient with hypertension includes a thorough medical history, a complete physical examination, and routine laboratory tests as described earlier. Additional diagnostic tests or procedures may be performed to detect secondary causes of hypertension or to make a definitive

diagnosis. Patients found to have an identifiable cause for their hypertension should be treated for that disorder and may require a referral to a nephrologist or endocrinologist. Those without an identifiable cause are diagnosed with primary hypertension.

Classification and diagnosis of BP (see Table 3.1) are based on an average of two or more properly measured BP readings obtained in the seated patient on each of two or more office visits.¹ Measurement of BP has been traditionally achieved using the auscultatory method with a manual aneroid (with a dial) or hybrid sphygmomanometer. Electronic automated devices are now commonly used (see Fig. 3.1). In a patient who has been quietly seated for 5 minutes, the appropriate sized cuff is placed around the upper arm, at the vertical height of the heart, and the cuff is inflated to obtain a proper reading (see Chapter 1). Clinicians should realize that BP varies throughout the day, and accurate measurements are important for achieving the proper diagnosis and treatment.¹⁹

Patients with a diagnosis of prehypertension are not usually candidates for drug therapy but rather are encouraged to adopt lifestyle modifications to decrease their risk of developing the disease. Prehypertension is not a disease but rather a designation that reflects the fact that these patients are at increased risk for the development of hypertension. Lifestyle modifications include losing weight; adopting a diet rich in vegetables, fruits, and low-fat dairy products; reducing intake of foods high in cholesterol and saturated fats; decreasing sodium intake; limiting alcohol intake; quitting smoking; and engaging in daily aerobic physical activity (Box 3.3). Patients with prehypertension, as well as those with diagnosed hypertension, are strongly encouraged to follow these recommendations because lifestyle modifications have been shown to effectively reduce BP, prevent or delay the incidence of

hypertension, enhance antihypertensive drug therapy, and decrease cardiovascular risk.¹ If lifestyle modifications are found to be inadequate for achieving desired BP reduction, drug therapy is initiated.

Pharmacologic management of hypertension is guided by two recent publications from JNC 8 and the American Society of Hypertension (ASH) and the International Society of Hypertension (IHS).^{18,20} Current guidelines suggest that all people with hypertension—stages 1 and 2—should be treated. JNC 8 recommends drug treatment should be initiated for persons younger than age 60 years when the BP is greater than 140/90 mm Hg, to a goal of less than 140/90 mm Hg.¹⁸ The ASH/ISH and the Canadian Hypertension Education Program guidelines recommend a goal of less than 140/90 mm Hg up to age 80 years.^{20,21} For older adults (aged 60 years and older¹⁸ or 80 years and older^{20,21}) the goal is to lower BP to less than 150/90 mm Hg. The ASH/ISH also recommends a goal of less than 130/80 mm Hg for patients with chronic kidney disease who have albuminuria.²⁰ Although meta-analysis studies show that cardiovascular benefits can be achieved from more intensive BP lowering (i.e., levels <140/90) in high-risk groups,²² it may take a few years for the national guidelines to be adjusted to reflect these data.

Many drugs are currently available to treat patients with hypertension (Table 3.4). JNC 8 recommends diuretics, angiotensin-converting enzyme (ACE) inhibitors, angiotensin receptor blockers (ARBs), and calcium channel blockers (CCBs) as first-line choices for the general nonblack population. For the general black population, a thiazide diuretic or CCB is recommended as initial therapy. Other drugs used as secondary choices include beta-blockers, α_1 -adrenergic blockers, and central α_2 agonists, as well as other centrally acting drugs and direct vasodilators. Fig. 3.2 depicts the algorithm suggested by the JNC 8 for the treatment of hypertension. For early stage 1 hypertension, single-drug therapy may be effective; however, for later stage 1 and for stage 2 hypertension, two or more drug combinations are necessary. The presence of certain comorbid conditions or factors such as heart failure, previous MI, diabetes, or kidney disease may be a compelling reason to select specific drugs or classes of drugs that have been found to be beneficial in clinical trials. Of note, aggressive pharmacologic treatment of hypertension has clear benefits.²³ In clinical trials, anti-hypertensive therapy resulted in an average reduction in stroke incidence of 35% to 40%; MI, 20% to 25%; and heart failure, greater than 50%.²⁴

Severe uncontrolled hypertension is defined in the JNC 7 guidelines as BP greater than 180/110 mm Hg.¹ When BP is greater than 180/120, the condition is called acute hypertension or hypertensive crisis. Two categories of hypertensive crisis are defined: hypertensive urgency or hypertensive emergency. A *hypertensive urgency* occurs when BP is greater than 180/120 mm Hg in the absence of progressive end-organ dysfunction. These persons may exhibit symptoms (headache, dyspnea, nosebleeds, or

BOX 3.3 Lifestyle Modifications for Prevention and Reduction of High Blood Pressure

- Weight loss
- DASH (Dietary Approaches to Stop Hypertension) diet: fruits, vegetables, low-fat dairy products
- Reduced intake of cholesterol-rich foods
- Reduced intake of saturated and total fats
- Reduced sodium intake to <2.4 g/day
- Regular aerobic physical activity on most days (30 minutes of brisk walking)
- Quit smoking
- Limited alcohol intake to no more than 1 oz/day (2 drinks for men and 1 drink for women)

Data from the National Heart, Lung, and Blood Institute: *The seventh report of the Joint National Committee on Prevention, Detection, Evaluation, and Treatment of High Blood Pressure: the JNC 7 report*, Bethesda, MD, US Department of Health and Human Services, Public Health Service, Bethesda, MD, National Institutes of Health, National Heart, Lung, and Blood Institute, August 2004.

TABLE 3.4 Drugs Used in the Management of Hypertension

Drug	Oral Adverse Effects	Dental Considerations
DIURETICS		
Thiazide Diuretics		
Chlorothiazide (Diuril), chlorthalidone (generic), hydrochlorothiazide (HCTZ) (HydroDIURIL, Microzide), polythiazide (Renese), indapamide (Lozol), metolazone (Mykrox), metolazone (Zaroxolyn)	Dry mouth, lichenoid reactions	Orthostatic hypotension; avoid prolonged use of NSAIDs—may reduce antihypertensive effects. Vasoconstrictor interactions: none
Loop Diuretics		
Bumetanide (Bumex), furosemide (Lasix), torsemide (Demadex)		
Potassium-Sparing Diuretics		
Amiloride (Midamor), triamterene (Dyrenium)		
Aldosterone Receptor Blockers		
Eplerenone (Inspra), spironolactone (Aldactone)		
Combination		
Aldactazide, Dyazide		
BETA BLOCKERS (BBS)		
Nonselective		
Propranolol (Inderal), timolol (Blocadren), nadolol (Corgard), pindolol (Visken), penbutolol (Levitol), carteolol (Cartrol)	Taste changes, lichenoid reactions	Avoid prolonged use of NSAIDs—may reduce antihypertensive effects. Vasoconstrictor interactions: nonselective—potential increase in blood pressure (use maximum of 0.036 mg of epinephrine); avoid levonordefrin
Cardioselective		
Metoprolol (Lopressor), acebutolol (Sectral), atenolol (Tenormin), betaxolol (Kerlone), bisoprolol (Zebeta)		Vasoconstrictor interactions: none
COMBINED ALPHA AND BETA BLOCKERS		
Carvedilol (Coreg), labetalol (Normodyne, Trandate)	Taste changes	Orthostatic hypotension; avoid prolonged use of NSAIDs—may reduce antihypertensive effects. Vasoconstrictor interaction: because both β_1 - and β_2 -adrenergic receptor sites are blocked, the potential for an adverse interaction is present; however, it is unlikely to occur because of compensatory α -adrenergic receptor blockade
ANGIOTENSIN-CONVERTING ENZYME (ACE) INHIBITORS		
Benazepril (Lotensin), captopril (Capoten), enalapril (Vasotec), fosinopril (Monopril), lisinopril (Prinivil; Zestril), moexipril (Univasc), perindopril (Aceon), quinapril (Accupril), ramipril (Altace)	Angioedema of lips, face, tongue; taste changes; oral burning	Orthostatic hypotension; avoid prolonged use of NSAIDs—may reduce antihypertensive effects. Vasoconstrictor interaction: none
ANGIOTENSIN RECEPTOR BLOCKERS (ARBs)		
Candesartan (Atacand), eprosartan (Teveten), irbesartan (Cozaar), olmesartan (Benicar), telmisartan (Micardis), valsartan (Diovan)	Angioedema of the lips, face, tongue	Orthostatic hypotension. Vasoconstrictor interaction: none

Continued

TABLE 3.4 Drugs Used in the Management of Hypertension—cont'd

Drug	Oral Adverse Effects	Dental Considerations
CALCIUM CHANNEL BLOCKERS (CCBS)		
Diltiazem (Cardizem), verapamil (Calan), amlodipine (Norvasc), felodipine (Plendil), isradipine (DynaCirc), nifedipine (Procardia), nisoldipine (Sular)	Gingival overgrowth	Avoid prescribing macrolide antibiotics that can cause higher plasma levels of CCBs resulting in hypotension. Vasoconstrictor interaction: none
α_1-ADRENERGIC BLOCKERS		
Doxazosin (Catapres), prazosin (Minipress), terazosin (Hytrin)	Dry mouth, taste changes	Orthostatic hypotension; avoid prolonged use of NSAIDs—may reduce antihypertensive effects. Vasoconstrictor interaction: none
CENTRAL α_2-ADRENERGIC AGONISTS AND OTHER CENTRALLY ACTING DRUGS		
Clonidine (Catapres), methyldopa (Aldomet), reserpine (generic), guanfacine (Tenex)	Dry mouth, taste changes	Orthostatic hypotension. Vasoconstrictor interaction: none
DIRECT VASODILATORS		
Hydralazine (Apresoline), minoxidil (Loniten)	Lupus-like oral and skin lesions, lymphadenopathy	Orthostatic hypotension; avoid prolonged use of NSAIDs—may reduce antihypertensive effects. Vasoconstrictor interaction: none

NSAID, Nonsteroidal antiinflammatory drug.

severe anxiety) and often are found to be noncompliant, under stress, or have an inadequate medication regimen. In contrast, a *hypertensive emergency* is characterized by a BP $\geq 180/120$ mm Hg with evidence of impending or progressive target organ dysfunction (i.e., hypertensive encephalopathy, intracerebral hemorrhage, eclampsia, acute MI, left ventricular failure with pulmonary edema, or unstable angina pectoris). A hypertensive emergency can be associated with chest pain, dyspnea, change in mental status, visual disturbance, or a neurologic deficit. Early treatment is required for patients with a hypertensive emergency (Table 3.5).¹

DENTAL MANAGEMENT

Medical Considerations

Identification. The first task of the dentist is to identify patients with hypertension, both diagnosed and undiagnosed. A medical history, including the diagnosis of hypertension, how it is being treated, identification of antihypertensive drugs, compliance status, presence of hypertension-associated symptoms and signs, and level of stability of the disease, should be obtained. On occasion, patients may fail to report that they have been diagnosed with hypertension yet may report taking medications, including herbal medications, typically advocated to treat high BP. This may be the only way for the clinician to uncover information revealing that the patient has hypertension. Patients also may be receiving treatment for complications of hypertensive disease, such as congestive heart failure, cerebrovascular disease, MI, renal disease, peripheral vascular disease, or diabetes mellitus. These

conditions should be identified as well because they may necessitate modification of the dental management plan.

In addition to a medical history, all new patients and all recall patients should undergo BP measurement on a routine basis (see Chapter 1).²⁵ More frequent BP measurements are indicated for patients who are not compliant with treatment, whose hypertension is poorly controlled, or who have comorbid conditions such as heart failure or previous MI or stroke. In patients who are being treated for hypertension but have BPs above normal, the most common reason for the persistent HBP is noncompliance or inadequate treatment; they should be encouraged to return to their physician for follow-up care. A patient who has not been diagnosed with hypertension but who has an abnormally elevated BP should also be encouraged to see his or her physician. When a patient with upper-level stage 2 BP is receiving dental treatment, consideration should be given to leaving the BP cuff on the patient's arm and periodically checking the pressure during the appointment. The dentist should not make a diagnosis of hypertension but rather should inform the patient that the BP reading is elevated and that a physician should evaluate the condition.

The primary concern in dental management of a patient with hypertension is that during the course of treatment, a sudden, acute elevation in BP might occur, potentially leading to a serious outcome such as stroke or MI. Such acute elevations in BP may result from the release of endogenous catecholamines in response to stress and anxiety, from injection of exogenous catecholamines in the form of vasoconstrictors in the local anesthetic, or from absorption of a vasoconstrictor from the gingival

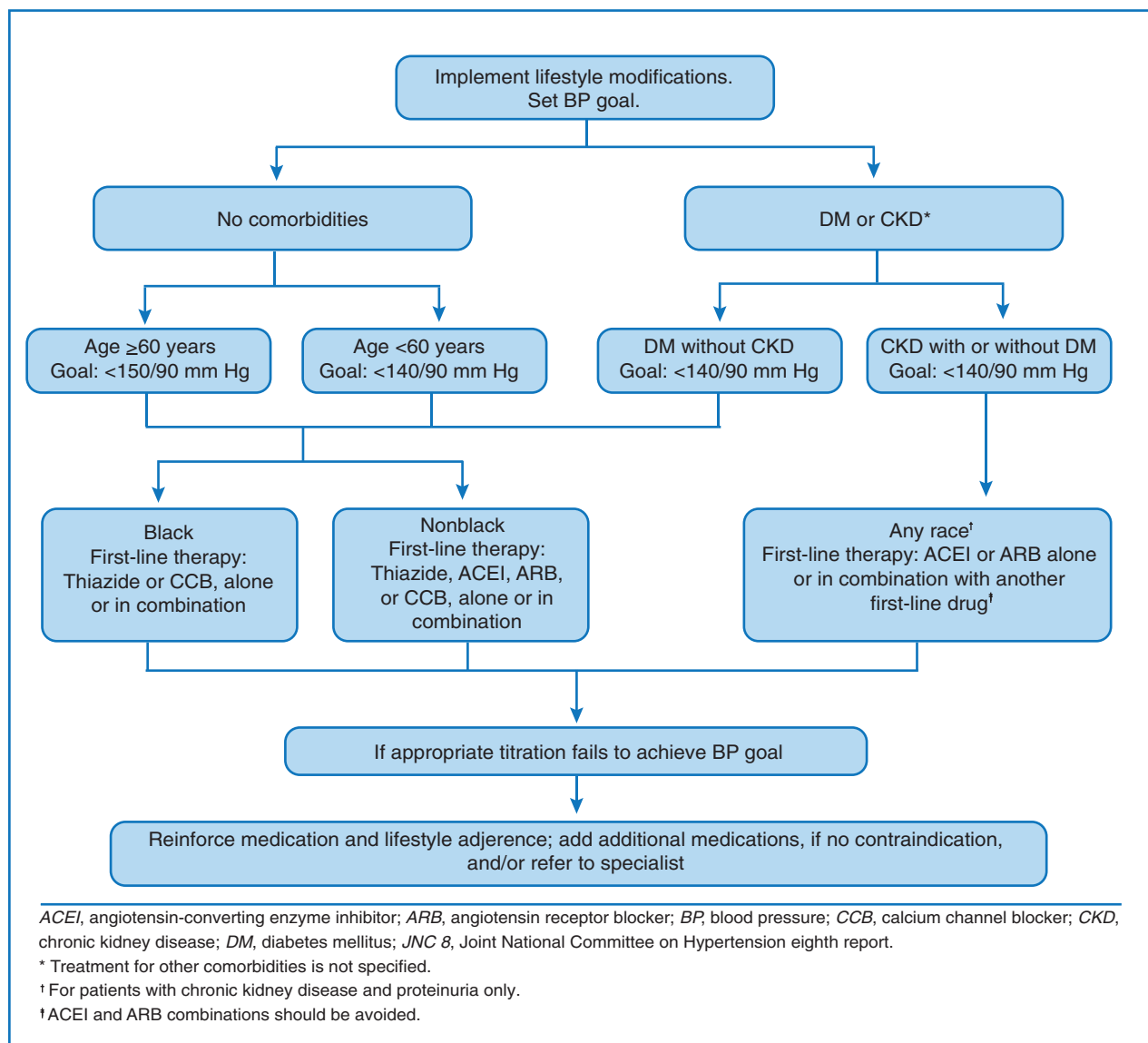

FIG 3.2 Joint National Committee on Prevention, Detection, Evaluation, and Treatment of High Blood Pressure 8 treatment recommendations and algorithm. (Redrawn from James PA, Oparil S, Carter BL, et al: 2014 evidence-based guideline for the management of high blood pressure in adults: report from the panel members appointed to the Eighth Joint National Committee (JNC 8), *JAMA* 311:507-520, 2014.)

TABLE 3.5 Expert Opinion on Management of Severe Uncontrolled Hypertension

Blood Pressure Reading (mm Hg)	Symptoms or Organ Damage	Recommendations
>180/110 (diastolic <120)	No	Treatment within 1 week—not an emergency; gradually lower BP during a period of days and before surgical procedures
>180/120	Yes	Early treatment; gradually reduce BP with short-acting oral antihypertensives; hours of observation, and then follow-up visit within 1 to a few days
≥210/120	Yes or no	Immediate treatment* (reduce BP within 1 hour) with parental antihypertensives in hospital; hours of observation, and then follow-up visit with physician within 1 to a few days

*Immediate treatment: blood pressure (BP) reduction (within 1 hour) may require admission to an intensive care unit.

Based on Chobanian AV, Bakris GL, Black HR, et al. The Seventh Report of the Joint National Committee on Prevention, Detection, Evaluation, and Treatment of High Blood Pressure: the JNC 7 report. *JAMA* 289(19):2560-2572, 2003; Pak KJ, Hu T, Fee C, Wang R, Smith M, Bazzano LA. Acute hypertension: a systematic review and appraisal of guidelines. *Ochsner J.* 2014;14(4):655-63.⁴⁸

retraction cord.²⁶⁻²⁸ Other concerns include potential drug interactions between the patient's antihypertensive medications and the drugs used in dental practice and oral adverse effects that may be caused by antihypertensive medications.²⁹

Risk Assessment. Two important questions should be answered before dental treatment is provided for a patient with hypertension:

- What are the associated risks of treatment in this patient?
- At what level of BP is treatment unsafe for the patient?

The American College of Cardiology (ACC) and the American Heart Association (AHA) have jointly published practice guidelines for the perioperative evaluation of patients with cardiovascular disease for whom noncardiac surgery of various types is planned.^{30,31} These guidelines provide a framework to estimate the risk for occurrence of a stroke, MI, acute heart failure, or sudden death as a result of the surgery. Oral and maxillofacial surgery and periodontal surgery both are forms of noncardiac surgery; thus, these guidelines are directly applicable. In addition, the ACC/AHA guidelines may be extrapolated and applied to nonsurgical dental treatment, as well. In the practice guidelines,^{30,31} the determination of risk includes the evaluation of three factors: (1) the risk imposed by the patient's cardiovascular disease, (2) the risk imposed by the surgery or procedure, and (3) the risk imposed by the functional reserve or capacity of the patient.

The risk imposed by the presence of a specific cardiovascular condition or disease is stratified into major, intermediate, and minor risk categories (Box 3.4). Uncontrolled BP, defined as 180/110 mm Hg or greater, is classified as a minor risk condition; however, the ACC/AHA guidelines include a statement that BP should be brought under control before any surgery is performed. Of note, the JNC 7 classification recommends timely or immediate referral for patients with BP of 180/110 mm Hg or higher, depending on the presence or absence of symptoms (Table 3.6).

Risk imposed by the type of surgery (or procedure) also is stratified into high- (>5% risk), intermediate- (<5% risk), and low- (<1% risk) risk categories. In general, risk is greatest with vascular or emergency surgery, prolonged procedures, and procedures associated with excessive blood loss and general anesthesia (Box 3.5). Head and neck surgery, which may include major oral and maxillofacial procedures and extensive periodontal procedures, is classified as intermediate risk. Superficial surgical procedures, which include minor oral and periodontal surgery and nonsurgical dental procedures, are classified as low risk. Thus, it appears that the risk associated with most general, outpatient dental procedures is very low.

The third factor involved in risk assessment is determination of the ability of the patient to perform certain physical activities (functional capacity) and is defined in metabolic equivalents (METs) (see Chapter 1).

BOX 3.4 Clinical Predictors of Increased Perioperative Cardiovascular Risk

Major Risk Factors

- Unstable coronary syndromes
 - Acute or recent myocardial infarction[†] with evidence of important ischemic risk in clinical signs and symptoms or noninvasive study
 - Unstable or severe angina (Canadian class III or IV)^{†‡§}
- Decompensated heart failure
- Significant arrhythmias
- Severe valvular disease

Intermediate Risk Factors

- History of ischemic heart disease
- History of compensated or previous heart failure
- History of cerebrovascular disease
- Diabetes mellitus
- Renal insufficiency

Minor Risk Factors

- Advanced age (>70 years)
- Abnormal ECG (left ventricular hypertrophy, left bundle branch block, ST-T abnormalities)
- Rhythm other than sinus rhythm
- Uncontrolled systemic hypertension (blood pressure $\geq 180/110$ mm Hg)

*Cardiac events of myocardial infarction (MI), heart failure, or death.

[†]The American College of Cardiology National Database Library defines *recent MI* as occurring more than 7 days but within 1 month (at or before 30 days) before the procedure and *acute MI* as occurring within 7 days.

[‡]May include "stable" angina in patients who are unusually sedentary.

[§]Data from Campeau L: Grading of angina pectoris, *Circulation* 54:522-523, 1976. The Canadian classification is a system of grading angina severity (grades I-IV), with grade I angina occurring only with strenuous exertion and grade IV angina occurring with any physical activity or at rest.

ECG, Electrocardiogram.

Data from Fleisher LA, Beckman JA, Brown KA, et al: ACC/AHA 2007 guidelines on perioperative cardiovascular evaluation and care for noncardiac surgery: a report of the American College of Cardiology/American Heart Association Task Force on Practice Guidelines (Writing Committee to Revise the 2002 Guidelines on Perioperative Cardiovascular Evaluation for Noncardiac Surgery), *Circulation* 116:e418-e499, 2007.

Perioperative cardiac risk is increased in patients who are unable to meet a 4-MET demand during most normal daily activities, which is equivalent to climbing a flight of stairs. Thus, a patient who reports inability to climb a flight of stairs without chest pain, shortness of breath, or fatigue would be at increased risk during a procedure.

Readers should be aware of risk calculators now available to help predict the likelihood of a major adverse cardiac event (MACE) associated with noncardiac surgical procedures.³¹

Recommendations

Antibiotics. For patients who have hypertension, there is little to no risk of infection beyond that of a healthy patient. Antibiotics are not indicated.

TABLE 3.6 Dental Management and Follow-Up Recommendations Based on Blood Pressure

BLOOD PRESSURE (mm Hg)	Dental Treatment Recommendation	Follow-Up Recommendation
≤120/80	Any required	No physician referral necessary
≥120/80 but <140/90	Any required	Encourage patient to see physician
≥140/90 but <160/100	Any required	Encourage patient to see physician
≥160/100 but <180/110	Any required; consider intraoperative monitoring of BP for upper-level stage 2 hypertension	Refer patient to physician promptly (within 1 month)
≥180/110	Defer elective treatment	Refer to physician as soon as possible; if patient is symptomatic, refer immediately

BOX 3.5 Cardiac Risk Stratification for Noncardiac Surgical Procedures

High (Reported Cardiac Risk Often >5%)

- Aortic and other major vascular surgery
- Peripheral vascular surgery

Intermediate (Reported Cardiac Risk Generally <5%)

- Intraperitoneal and intrathoracic surgery
- Carotid endarterectomy
- Head and neck surgery
- Orthopedic surgery
- Prostate surgery

Low (Reported Cardiac Risk Generally <1%)

- Endoscopic procedures
- Superficial procedures
- Cataract surgery
- Breast surgery
- Ambulatory surgery

*Combined incidence of cardiac death and nonfatal myocardial infarction.

Adapted from Fleisher LA, Beckman JA, Brown KA, et al: ACC/AHA 2007 guidelines on perioperative cardiovascular evaluation and care for noncardiac surgery: executive summary: a report of the American College of Cardiology/American Heart Association Task Force on Practice Guidelines (Writing Committee to Revise the 2002 Guidelines on Perioperative Cardiovascular Evaluation for Noncardiac Surgery), *Circulation* 116:1971-1996, 2007.

Bleeding. Hypertension rarely causes concern for bleeding after dental procedures. A patient with hypertension who has cardiovascular comorbidities, such as previous MI or stroke, may be taking daily aspirin or another antiplatelet agents (e.g., clopidogrel). Surgical procedures can be performed normally under these circumstances. If the patient is taking an anticoagulant, additional precautions are advised (see [Chapters 4](#) and [24](#)).

Blood Pressure. [Table 3.6](#) provides dental management recommendations for patients with various levels of BP. In summary, patients with BPs less than 180/110 mm Hg can undergo any necessary dental treatment, both surgical and nonsurgical, with very little risk of an adverse outcome. For patients found to have asymptomatic BP of 180/110 mm Hg or greater (uncontrolled hypertension), elective dental care should be deferred, and a physician referral for evaluation and treatment within 1 week is

indicated. Patients with uncontrolled BP associated with symptoms such as headache, shortness of breath, or chest pain should be referred to a physician for immediate evaluation. In patients with uncontrolled hypertension, certain problems such as pain, infection, or bleeding may necessitate urgent dental treatment. In such instances, the patient should be managed in consultation with the physician, and measures such as intraoperative BP monitoring, ECG monitoring, establishment of an intravenous line, and sedation may be used. The decision must always be made as to whether the benefit of proposed treatment outweighs the potential risks.

If treatment of a patient with upper-level stage 2 hypertension is provided, it may be advisable to leave the BP cuff on the patient's arm and to periodically check the pressure. If the BP rises above 179/109 mm Hg, the procedure should be terminated, the patient referred to his or her physician, and the appointment rescheduled.

Capacity to Tolerate Care. After it has been determined that the patient with hypertension can be safely treated, a management plan should be developed ([Box 3.6](#)). For all patients, the dentist should make every effort to reduce as much as possible the stress and anxiety associated with dental treatment. This consideration is of particular importance in patients with hypertension. A critical factor in providing an anxiety-free situation is the relationship established among the dentist, the office staff, and the patient. Patients should be encouraged to express and discuss their fears, concerns, and questions about dental treatment.

Stress management is important for patients with hypertension to lessen the chances of endogenous release of catecholamines during the dental visit (see [Chapter 1](#)). Long or stressful appointments are best avoided. Short morning appointments seem best tolerated. If the patient becomes anxious or apprehensive during the visit, the appointment may be terminated and rescheduled for another day. Anxiety can be reduced for many patients by oral premedication with a short-acting benzodiazepine such as triazolam (Halcion; Pharmacia & Upjohn, Kalamazoo, MI), taken 1 hour before the start of the dental appointment. The dose is dictated by the age and size of the patient and is determined in accordance with prescribing guidelines for the agent selected. Nitrous oxide plus oxygen for inhalation sedation is an excellent

BOX 3.6 Dental Management Recommendations for Patients With Hypertension

<p>P Patient Evaluation and Risk Assessment (see Box 1.1)</p> <ul style="list-style-type: none"> Evaluate and determine if hypertension exists. Refer patient to physician if blood pressure is poorly controlled or if the condition is untreated. 		<p>BP</p> <p>Monitor BP. Patients with a BP <180/110 mm Hg may receive any necessary dental treatment. For patients with a pressure reading >180/110 mm Hg, dental treatment should be deferred until BP is brought under control. If urgent or emergency dental treatment is required, it should be done in as limited and conservative a manner as possible.</p>	
<p>Potential Issues and Factors of Concern</p>		<p>C</p>	
<p>A</p>		<p>D</p>	
Antibiotics	Avoid the use of erythromycin and clarithromycin (not azithromycin) with CCBs because the combination can enhance hypotension.	Capacity to tolerate care	A BP >180/120 mm Hg is a hypertensive crisis, which dictates provision of immediate medical care.
Analgesics	Avoid long-term (>2 weeks) use of NSAIDs because these agents may interfere with effectiveness of some antihypertensive medications.	Chair position	Avoid rapid position changes owing to possibility of antihypertensive drug-associated orthostatic hypotension.
Anesthesia	Modest doses of local anesthetic with 1:100,000 or 1:200,000 epinephrine (e.g., 1 or 2 carpules) at a given time are of little clinical consequence in patients with BP <180/110 mm Hg. Greater quantities may be tolerated reasonably well but with increased risk. Levonordefrin should be avoided. In patients with uncontrolled hypertension (BP >180/110 mm Hg), the use of epinephrine should be limited.	Drugs	Several of the antihypertensive drugs have reported oral manifestations. Nonselective β -adrenergic blockers can potentially interact with epinephrine, but such interaction is dose dependent and very unlikely to occur at the usual doses.
Anxiety	Patients with hypertension who are anxious or fearful are especially good candidates for preoperative oral or intraoperative inhalation sedation (or both). Apply good stress management protocols.	Devices	For patients with stage II hypertension (BP >160/100 mm Hg), periodic monitoring of BP during treatment may be advisable.
<p>B</p>		Equipment	No issues
Bleeding	Excessive bleeding caused by hypertension is possible but unlikely.	Emergencies	Patients with hypertension are at increased risk for cardiovascular disease; thus, although unlikely, angina, stroke, arrhythmia, and MI should all be anticipated as possible occurrences.
Breathing	No issues	Follow-up	Schedule follow-up appointment as needed if the patient is referred to a physician.
		<p>E</p>	
		<p>F</p>	

BP, Blood pressure; CCB, calcium channel blocker; MI, myocardial infarction; NSAID, nonsteroidal antiinflammatory drug.

intraoperative anxiolytic for use in patients with hypertension. Care is indicated to ensure adequate oxygenation at all times and avoiding postdiffusion hypoxia at the termination of administration. Hypoxia is to be avoided because of the resultant rebound elevation in BP that may occur.

Chair. Because some antihypertensive agents, especially alpha-blockers, alpha-beta-blockers, and diuretics, tend to produce orthostatic hypotension as a side effect, rapid changes in chair position during dental treatment should be avoided. This effect can be potentiated by the actions of anxiolytic and sedative drugs. Thus, when treatment has concluded for that appointment, the dental chair should be returned slowly to an upright position. After sufficient time to permit adjustment to the change in posture, the patient should be physically supported while

slowly getting out of the chair to ensure that good balance and stability have been regained. A patient who experiences dizziness or lightheadedness should be directed to sit back down to allow safe recovery of equilibrium.

Drug Considerations. Ambulatory (outpatient) general anesthesia in the dental office generally is recommended only for patients whose status on the American Society of Anesthesiologists (ASA) classification is ASA I (status of a healthy, normal patient) or ASA II (presence of mild to moderate systemic disease). Some patients with severe hypertension may be excluded.

Use of Vasoconstrictors. Profound local anesthesia is critical for pain and anxiety control and is especially important for patients with hypertension or other cardiovascular disease to decrease endogenous catecholamine release. The effectiveness of local anesthesia is enhanced

by the inclusion of a vasoconstrictor in the local anesthetic solution, which delays systemic absorption, increases the duration of anesthesia, and provides local hemostasis. These properties allow for enhanced quality and duration of pain control and markedly facilitate performance of the technical procedures. Thus, the advantages of including a vasoconstrictor in the local anesthetic are obvious. Concerns have emerged, however, that the use of local anesthetic with a vasoconstrictor in a patient with hypertension could result in a potentially serious spike in BP.

The cardiovascular response to conventional doses of injected epinephrine, both in patients who are healthy and in those with hypertension, usually is of little clinical importance. A meta-analysis of several clinical studies determined that the mean resting venous plasma epinephrine concentration is 39 pg/mL; this is approximately doubled by the intraoral injection of a single cartridge of 2% lidocaine with 1:100,000 epinephrine.²⁷ This resulting elevation in plasma epinephrine is linear and dose dependent. Although large doses of epinephrine may cause a significant rise in BP and heart rate, small doses such as those contained in one or two cartridges of lidocaine with 1:100,000 epinephrine cause minimal physiologic changes (Fig. 3.3). This fact is due to a preponderance of action among β_2 receptors and a decrease in diastolic pressure; thus, mean arterial pressure is essentially unchanged, with only a minimal increase in heart rate.

Several clinical investigations have evaluated changes in plasma epinephrine concentration and hemodynamic parameters in healthy patients after dental injections of 2% lidocaine with 1:100,000 epinephrine. After injection

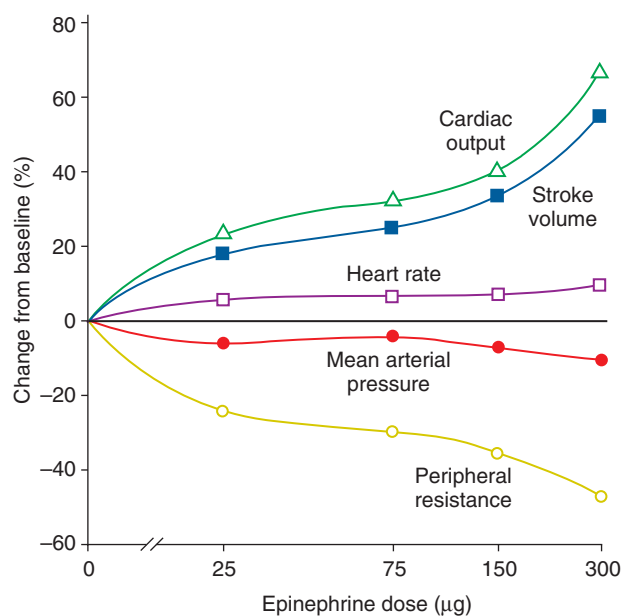

FIG 3.3 Cardiovascular effects of epinephrine when used in regional anesthesia. (Redrawn from Jastak JT, Yagiela JA, Donaldson D: *Local anesthesia of the oral cavity*, Philadelphia, 1995, Saunders.)

of 1.8 mL (one cartridge), plasma levels increased two- to threefold, but no significant changes were observed in heart rate or BP.^{27,32,33} With 5.4 mL of solution (three cartridges), however, plasma levels increased five- to sixfold; these changes were accompanied by significant increases in heart rate and systolic BP but with no adverse symptoms or sequelae. The critical question, then, is how a particular patient with hypertension or other cardiovascular disease will react to these dose challenges of epinephrine.

A systematic review of the literature on the cardiovascular effects of epinephrine in hypertensive dental patients³⁴ concluded that although the quantity and quality of pertinent articles were problematic, the increased risk of adverse events among patients with uncontrolled hypertension was low, and the reported occurrence of adverse events associated with the use of epinephrine in local anesthetic agents was minimal. This review was cited by the JNC 7 report¹ and supported its conclusions. Another recent review of this subject noted an absence of adverse case reports involving epinephrine in local anesthetics and cited the numerous studies that demonstrated the safety and efficacy of these preparations.²⁶

Thus, the existing evidence indicates that use of modest doses (one or two cartridges of 2% lidocaine with 1:100,000 epinephrine) carries little clinical risk in patients with hypertension, and the benefits of its use far outweighing any potential problems. Use of more than this amount at one time may be tolerated but with increasing risk for adverse hemodynamic changes. Levonordefrin should be avoided in patients with hypertension, however, because of its comparative excessive α_1 stimulation. The use of epinephrine generally is not advised in patients with uncontrolled hypertension, in whom elective dental care should be deferred. If urgent treatment becomes necessary, however, a decision must be made regarding the use of epinephrine, which will be dictated by the situation. A reasonable conclusion from all of the available evidence is that the benefits of use of epinephrine outweigh the increased risks, so long as modest doses (e.g., 1 or 2 carpules) are used at one time and care is taken to avoid inadvertent intravascular injection. Consultation with the patient's physician is advisable before a definitive decision is made.

Drug Interactions. An additional concern when patients with hypertension are treated is the potential for adverse drug interactions between vasoconstrictors and antihypertensive drugs—specifically, the nonselective β -adrenergic blocking agents. The basis for concern with use of nonselective β -adrenergic blocking agents (e.g., propranolol) is that the normal compensatory vasodilatation of skeletal muscle vasculature mediated by β_2 receptors is inhibited by these drugs, and injection of epinephrine, levonordefrin, or any other pressor agent may result in uncompensated peripheral vasoconstriction because of unopposed stimulation of α_1 receptors. This vasoconstrictive effect could potentially cause a significant elevation

in BP and a compensatory bradycardia.^{35,36} Several cases of this interaction have been reported in the literature that resulted in BPs exceeding 190/110 mm Hg and at least one death.³⁷ However, the effect appears to be dose dependent, with the majority of adverse outcomes resulting when more than 3 carpules of local anesthetic with epinephrine were used.³⁷⁻³⁹ Adverse interactions are even less likely to occur in patients who take cardioselective beta-blockers and when 2 carpules or less are used.²⁹ Thus, the available evidence and clinical experience suggest that epinephrine in small doses of one to two cartridges containing 1:100,000 epinephrine can be used safely even in patients taking nonselective β -adrenergic-blocking agents. Indeed, Brown and Rhodus²⁶ concluded in their review that adverse drug interactions between beta-blockers and epinephrine were extremely unlikely; however, they noted that levonordefrin should be avoided.

Topical vasoconstrictors generally should not be used for local hemostasis in patients with hypertension. When performing crown and bridge procedures for patients with hypertension, the dentist should avoid using gingival retraction cord that contains epinephrine because this material contains highly concentrated epinephrine, which can be quickly absorbed through abraided gingival sulcus tissues, resulting in tachycardia and elevated BP. As an alternative, one study reported that tetrahydrozoline (Visine; Pfizer Inc., New York, NY), oxymetazoline (Afrin; Schering-Plough, Summit, NJ), and phenylephrine (Neo-Synephrine; Bayer, Morristown, NJ) may be used to soak the cord, providing hemostatic effects similar to those obtained with epinephrine but with minimal cardiovascular effects.⁴⁰

A few additional drug interactions should be considered. Erythromycin and clarithromycin can exacerbate the hypotensive effect of CCBs and result in acute kidney injury.⁴¹ Thus, this interaction should be avoided. Anxiolytics and sedatives may be used for patients who take these antihypertensive medications; however, the usual dosage may need to be reduced, especially in older adults. The efficacy of antihypertensive drugs may be decreased by the prolonged use of nonsteroidal antiinflammatory drugs (NSAIDs)—an interaction that should be considered if these drugs are used for analgesia, although the use of NSAIDs for a few days is of little clinical importance.⁴²

Oral Manifestations. Oral complications have not been associated with hypertension itself. The development of facial palsy has been described in the occasional patient with malignant hypertension.⁴³ Excessive bleeding after surgical procedures or trauma has been reported in patients with severe hypertension⁴⁴; however, such bleeding in this patient population is uncommon. Patients who take antihypertensive drugs, especially diuretics, may report dry mouth. Mercurial diuretics may cause oral lesions with an allergic or toxic basis. Lichenoid reactions have been reported with thiazides, methyl dopa, propranolol, and labetalol. ACE inhibitors may cause neutropenia, resulting in delayed healing or gingival



FIG 3.4 Gingival hyperplasia in a patient taking a calcium channel blocker. (Courtesy of Dr. Terry Wright.)

bleeding. Angioedema, a persistent cough, and oral burning sensations are also associated with ACE inhibitor use.^{45,46} CCBs can cause gingival overgrowth⁴⁷ (Fig. 3.4; see also Table 3.4).

REFERENCES

1. Chobanian AV, Bakris GL, Black HR, et al. The Seventh Report of the Joint National Committee on Prevention, Detection, Evaluation, and Treatment of High Blood Pressure: the JNC 7 report. *JAMA*. 2003;289(19):2560-2572.
2. National High Blood Pressure Education Program Working Group on High Blood Pressure in C, Adolescents. The fourth report on the diagnosis, evaluation, and treatment of high blood pressure in children and adolescents. *Pediatrics*. 2004;114(2 suppl 4th Report):555-576.
3. <http://www.cdc.gov/nchs/fastats/hypertension.htm>.
4. Nwankwo T, Yoon SS, Burt V, et al. Hypertension among adults in the United States: National Health and Nutrition Examination Survey, 2011-2012. *NCHS Data Brief*. 2013;133:1-8.
5. Burt VL, Whelton P, Roccella EJ, et al. Prevalence of hypertension in the US adult population. Results from the Third National Health and Nutrition Examination Survey, 1988-1991. *Hypertension*. 1995;25(3):305-313.
6. Victor R. *Arterial Hypertension*. *Goldman-Cecil Medicine*. 25th ed. Philadelphia: Saunders; 2016:381-397.
7. Franklin SS, Jacobs MJ, Wong ND, et al. Predominance of isolated systolic hypertension among middle-aged and elderly US hypertensives: analysis based on National Health and Nutrition Examination Survey (NHANES) III. *Hypertension*. 2001;37(3):869-874.
8. Franklin SS. Hypertension in older people: part 1. *J Clin Hypertens (Greenwich)*. 2006;8(6):444-449.
9. Bolivar JJ. Essential hypertension: an approach to its etiology and neurogenic pathophysiology. *Int J Hypertens*. 2013;2013:547809.
10. Lewington S, Clarke R, Qizilbash N, et al. Age-specific relevance of usual blood pressure to vascular mortality:

- a meta-analysis of individual data for one million adults in 61 prospective studies. *Lancet*. 2002;360(9349):1903-1913.
11. Miura K, Daviglius ML, Dyer AR, et al. Relationship of blood pressure to 25-year mortality due to coronary heart disease, cardiovascular diseases, and all causes in young adult men: the Chicago Heart Association Detection Project in Industry. *Arch Intern Med*. 2001;161(12):1501-1508.
 12. Barengo NC, Kastarinen M, Antikainen R, et al. The effects of awareness, treatment and control of hypertension on cardiovascular and all-cause mortality in a community-based population. *J Hum Hypertens*. 2009;23(12):808-816.
 13. Kung H-C, Xu J. Hypertension-related mortality in the United States, 2000–2013. *NCHS Data Brief*. 2015; 193.
 14. Victor R, Kaplan A. Systemic hypertension: mechanisms and diagnosis. In: Libby P, ed. *Braunwald's Heart Disease: A Textbook of Cardiovascular Medicine*. 8th ed. Philadelphia: Saunders; 2008:1027-1048.
 15. Pickering TG. Isolated diastolic hypertension. *J Clin Hypertens (Greenwich)*. 2003;5(6):411-413.
 16. Pickering TG, Hall JE, Appel LJ, et al. Recommendations for blood pressure measurement in humans and experimental animals: part 1: blood pressure measurement in humans: a statement for professionals from the Subcommittee of Professional and Public Education of the American Heart Association Council on High Blood Pressure Research. *Circulation*. 2005;111(5):697-716.
 17. Reinprecht F, Elmstahl S, Janzon L, et al. Hypertension and changes of cognitive function in 81-year-old men: a 13-year follow-up of the population study "Men born in 1914", Sweden. *J Hypertens*. 2003;21(1):57-66.
 18. James PA, Oparil S, Carter BL, et al. 2014 evidence-based guideline for the management of high blood pressure in adults: report from the panel members appointed to the Eighth Joint National Committee (JNC 8). *JAMA*. 2014;311(5):507-520.
 19. Chen L, Yang G. Recent advances in circadian rhythms in cardiovascular system. *Front Pharmacol*. 2015;6: 71.
 20. Weber MA, Schiffrin EL, White WB, et al. Clinical practice guidelines for the management of hypertension in the community a statement by the American Society of Hypertension and the International Society of Hypertension. *J Hypertens*. 2014;32(1):3-15.
 21. Dasgupta K, Quinn RR, Zarnke KB, et al. The 2014 Canadian Hypertension Education Program recommendations for blood pressure measurement, diagnosis, assessment of risk, prevention, and treatment of hypertension. *Can J Cardiol*. 2014;30(5):485-501.
 22. Xie X, Atkins E, Lv J, et al. Effects of intensive blood pressure lowering on cardiovascular and renal outcomes: updated systematic review and meta-analysis. *Lancet*. 2016;387(10017):435-443.
 23. Wright JM, Musini VM. First-line drugs for hypertension. *Cochrane Database Syst Rev*. 2009;(3):CD001841.
 24. Turnbull F. Blood Pressure Lowering Treatment Trialists C. Effects of different blood-pressure-lowering regimens on major cardiovascular events: results of prospectively- designed overviews of randomised trials. *Lancet*. 2003; 362(9395):1527-1535.
 25. Sheridan S, Pignone M, Donahue K. Screening for high blood pressure: a review of the evidence for the U.S. Preventive Services Task Force. *Am J Prev Med*. 2003;25(2):151-158.
 26. Brown RS, Rhodus NL. Epinephrine and local anesthesia revisited. *Oral Surg Oral Med Oral Pathol Oral Radiol Endod*. 2005;100(4):401-408.
 27. Cioffi GA, Chernow B, Glahn RP, et al. The hemodynamic and plasma catecholamine responses to routine restorative dental care. *J Am Dent Assoc*. 1985;111(1):67-70.
 28. Hatch CL, Chernow B, Terezhalmay GT, et al. Plasma catecholamine and hemodynamic responses to the placement of epinephrine-impregnated gingival retraction cord. *Oral Surg Oral Med Oral Pathol*. 1984;58(5): 540-544.
 29. Hersh EV, Giannakopoulos H. Beta-adrenergic blocking agents and dental vasoconstrictors. *Dent Clin North Am*. 2010;54(4):687-696.
 30. Fleisher LA, Beckman JA, Brown KA, et al. ACC/AHA 2007 Guidelines on Perioperative Cardiovascular Evaluation and Care for Noncardiac Surgery: Executive Summary: A Report of the American College of Cardiology/American Heart Association Task Force on Practice Guidelines (Writing Committee to Revise the 2002 Guidelines on Perioperative Cardiovascular Evaluation for Noncardiac Surgery): Developed in Collaboration With the American Society of Echocardiography, American Society of Nuclear Cardiology, Heart Rhythm Society, Society of Cardiovascular Anesthesiologists, Society for Cardiovascular Angiography and Interventions, Society for Vascular Medicine and Biology, and Society for Vascular Surgery. *Circulation*. 2007;116(17):1971-1996.
 31. Fleisher LA, Fleischmann KE, Auerbach AD, et al. ACC/AHA guideline on perioperative cardiovascular evaluation and management of patients undergoing noncardiac surgery. *J Am Coll Cardiol*. 2014;64(22): e77-e137.
 32. Tolas AG, Pflug AE, Halter JB. Arterial plasma epinephrine concentrations and hemodynamic responses after dental injection of local anesthetic with epinephrine. *J Am Dent Assoc*. 1982;104(1):41-43.
 33. Chernow B, Balestrieri F, Ferguson CD, et al. Local dental anesthesia with epinephrine. Minimal effects on the sympathetic nervous system or on hemodynamic variables. *Arch Intern Med*. 1983;143(11):2141-2143.
 34. Bader JD, Bonito AJ, Shugars DA. A systematic review of cardiovascular effects of epinephrine on hypertensive dental patients. *Oral Surg Oral Med Oral Pathol Oral Radiol Endod*. 2002;93(6):647-653.
 35. Houben H, Thien T, van 't Laar A. Effect of low-dose epinephrine infusion on hemodynamics after selective and nonselective beta-blockade in hypertension. *Clin Pharmacol Ther*. 1982;31(6):685-690.
 36. Reeves RA, Boer WH, DeLeve L, et al. Nonselective beta-blockade enhances pressor responsiveness to epinephrine, norepinephrine, and angiotensin II in normal man. *Clin Pharmacol Ther*. 1984;35(4):461-466.

37. Foster CA, Aston SJ. Propranolol-epinephrine interaction: a potential disaster. *Plast Reconstr Surg.* 1983;72(1):74-78.
38. Kram J, Bourne HR, Melmon KL, et al. Letter: propranolol. *Ann Intern Med.* 1974;80(2):282.
39. Mito RS, Yagiela JA. Hypertensive response to levonordefrin in a patient receiving propranolol: report of case. *J Am Dent Assoc.* 1988;116(1):55-57.
40. Bowles WH, Tardy SJ, Vahadi A. Evaluation of new gingival retraction agents. *J Dent Res.* 1991;70(11):1447-1449.
41. Gandhi S, Fleet JL, Bailey DG, et al. Calcium-channel blocker-clarithromycin drug interactions and acute kidney injury. *JAMA.* 2013;310(23):2544-2553.
42. Oates JA, FitzGerald GA, Branch RA, et al. Clinical implications of prostaglandin and thromboxane A₂ formation (1). *N Engl J Med.* 1988;319(11):689-698.
43. Tomek M, Nandoskar A, Chapman N, et al. Facial nerve palsy in the setting of malignant hypertension: a link not to be missed. *QJM.* 2015;108(2):145-146.
44. Knapp JF, Fiori T. Oral hemorrhage associated with periodontal surgery and hypertensive crisis. *J Am Dent Assoc.* 1984;108(1):49-51.
45. Tai S, Mascaro M, Goldstein NA. Angioedema: a review of 367 episodes presenting to three tertiary care hospitals. *Ann Otol Rhinol Laryngol.* 2010;119(12):836-841.
46. Brown RS, Farquharson AA, Sam FE, et al. A retrospective evaluation of 56 patients with oral burning and limited clinical findings. *Gen Dent.* 2006;54(4):267-271, quiz 72, 89-90.
47. Livada R, Shiloah J. Calcium channel blocker-induced gingival enlargement. *J Hum Hypertens.* 2014;28(1):10-14.
48. Pak KJ, Hu T, Fee C, et al. Acute hypertension: a systematic review and appraisal of guidelines. *Ochsner J.* 2014;14(4):655-663.

Ischemic Heart Disease

Coronary atherosclerotic heart disease is the leading health problem in the United States and the world. Atherosclerosis is the thickening of the intimal layer of the arterial wall caused by the accumulation of lipid plaques. The atherosclerotic process results in a narrowed arterial lumen with diminished blood flow and oxygen supply. Atherosclerosis is the most common underlying cause of coronary heart disease (angina and myocardial infarction [MI]), cerebrovascular disease (stroke), and peripheral arterial disease (intermittent claudication).

Symptomatic coronary atherosclerotic heart disease often is referred to as ischemic heart disease. Ischemic symptoms are the result of oxygen deprivation secondary to reduced blood flow to a portion of the myocardium. Other conditions such as embolism, coronary ostial stenosis, coronary artery spasm, and congenital abnormalities also may cause ischemic heart disease. Dental practitioners should be aware that these patients are at risk for angina, MI, stroke, or peripheral artery disease.

EPIDEMIOLOGY

More than 85 million Americans ($\approx 25\%$ of the population) have some form of cardiovascular disease, with about 15.5 million having coronary heart disease.¹ Cardiovascular disease begins early in life, and autopsy studies have shown that one in six American teenagers already has pathologic intimal thickening of the coronary arteries.²⁻⁴ The incidence and prevalence of ischemic heart disease increase with age, its symptoms and complications typically manifest later in midlife, and more than half of those affected are older than 59 years of age.^{1,3,4}

The annual mortality rate for cardiovascular diseases as a group has been declining since 1970.¹ Despite this decline, cardiovascular diseases continue to be the leading cause of death in the United States, accounting for about 31% of all deaths.¹ Coronary heart disease is the leading cause of death in the United States after age 65 years, and it is responsible for 735,000 new or recurrent heart attacks annually, of which more than 40% are fatal.^{1,5} Of the 735,000 Americans who have a heart attack each year, it is a first heart attack for 525,000 and a recurrent heart attack in the remaining 210,000.⁶ Men are at higher risk than women for having a heart attack or fatal coronary heart disease, and black men are at highest risk.

The average dental practice with 2000 patients is expected to include at least 100 patients with ischemic heart disease.

ETIOLOGY

The cause of coronary atherosclerosis is related to a variety of risk factors. These risk factors include male gender, older age, a family history of cardiovascular disease, hyperlipidemia, hypertension, cigarette smoking, physical inactivity, obesity, insulin resistance and diabetes mellitus, mental stress, and depression. In addition to these conventional risk factors, markers of inflammation such as C-reactive protein (CRP, an inflammatory marker), homocysteine, fibrinogen (procoagulant), plasminogen activator inhibitor (thrombolytic), and lipoprotein (a) are associated with atherosclerosis.^{1,5}

Before the age of 75 years, the risk of coronary atherosclerosis is greater for men than for women.^{1,5} MI and sudden death are rare in premenopausal women; however, after menopause, a rapid reduction occurs in this gender difference. The fact that men are more prone to the clinical manifestations of coronary atherosclerosis is accentuated in nonwhite populations (e.g., African Americans, Native Americans, Hispanics).

Genetics also play a role. Studies have confirmed that a paternal history, sibling history, or history in both parents of coronary atherosclerotic heart disease increases the risk for development of the disease at a younger age than that typical for those without such a history.⁷⁻⁹

Elevation in serum lipid levels is a major risk factor for atherosclerosis. Increased levels of low-density lipoprotein (LDL) cholesterol pose the greatest risk for coronary atherosclerosis, whereas increased levels of high-density lipoprotein (HDL) cholesterol have been shown to reduce the risk.⁵ Persons with elevated triglyceride or β -lipoprotein levels have an increased risk for the disease. Obesity and a diet rich in total calories, saturated fats, cholesterol, sugars, and salts also enhance the risk of developing cardiovascular disease.^{1,5}

Increased blood pressure is one of the most significant risk factors for coronary atherosclerotic heart disease.¹ In general, systolic blood pressure (SBP) is more strongly related to the incidence of cardiovascular disease than is diastolic blood pressure (DBP), especially in older adults.⁵

SBP rises throughout life, and DBP tends to level off or decrease after the age of 50 years. Most epidemiologic studies, however, recognize the importance of both DBP and SBP in the assessment of cardiovascular risk. It has been shown that morbidity and mortality increase linearly with blood pressures greater than 115/75 mm Hg.¹⁰ In the Framingham Study, even prehypertension (defined as SBP of 130 to 139 mm Hg and DBP of 85 to 89 mm Hg) was associated with a risk of cardiovascular disease double that for lower pressures.¹¹

Cigarette smoking is the single most important modifiable risk factor for coronary heart disease (see [Chapter 8](#)).¹ Multiple prospective studies have clearly documented that, compared with nonsmokers, persons who smoke 20 or more cigarettes daily have a two- to fourfold increase in coronary heart disease.¹² This increased risk appears to be proportionate to the number of cigarettes smoked per day, and quitting has well-documented benefits. In a study of 113,752 women and 88,496 men, smokers who quit by age 34 years gained 10 years of life, those quitting between 35 and 44 years gained 9 years, and those 45 to 54 years gained 6 years of life, on average, compared with those who continued to smoke.¹³ Pipe and cigar smoking apparently convey minor risk for development of heart disease.

Patients with diabetes mellitus have a greater incidence of coronary atherosclerotic heart disease and more extensive lesions. They develop the condition at an earlier age than that typical for persons who do not have diabetes. Almost 81 million Americans have some degree of abnormal glucose tolerance (prediabetes)—a condition along with obesity that markedly increases the risk for type 2 diabetes and premature atherosclerosis.¹ Patients with diabetes have two- to eightfold higher rates of future cardiovascular events compared with age-matched and ethnically matched nondiabetic patients.^{1,14} Three fourths of all deaths among patients with diabetes result from coronary heart disease.¹⁵ Compared with unaffected persons, patients with diabetes have a greater degree of atherosclerosis in the major arteries and in the microvascular circulation. Although hyperglycemia is associated with microvascular disease, insulin resistance itself promotes atherosclerosis even before it produces frank diabetes, and available data corroborate the role of insulin resistance as an independent risk factor for atherothrombosis.¹⁶ Metabolic syndrome is the term used to describe a cluster of pathologic findings consisting of obesity, insulin resistance, low HDL cholesterol, elevated triglycerides, and hypertension, all of which are risk factors for atherosclerosis. The recognized importance of this clinical syndrome as a setting for the development of atherosclerosis reflects a synergistic effect of the multiple risk factors. The prevalence of metabolic syndrome among adults in the United States is estimated to be about 34%, which increases with age.¹⁷

Numerous studies have reported an association between periodontal disease and cardiovascular disease, raising

the question of whether periodontal disease is a risk factor for cardiovascular disease.^{18,19} Although the mechanism to explain this relationship is unclear, evidence is accumulating that the chronic inflammatory burden of periodontal disease may lead to impaired functioning of the vascular endothelium.^{20,21} At present, despite studies showing that tooth scaling is associated with decreased risk of cardiovascular disease outcomes²² and improved endothelial function,²³ a direct relationship (i.e., causation) between periodontal disease and cardiovascular disease has not been established.²⁴ Additional studies are required to further elucidate this relationship.

No single risk factor is responsible for the development of coronary atherosclerosis, but many factors act synergistically. Evidence suggests that modification of risk factors that can be controlled, such as cigarette smoking, hypertension, obesity, physical activity, hyperlipidemia, and diabetes, can reduce or modify the clinical effects of the disease.¹

PATHOPHYSIOLOGY AND COMPLICATIONS

Atherosclerosis is an inflammatory disorder of the cellular lining of the arteries, with inflammation playing a fundamental role at all stages of the disease.^{3,25} The formation of atheromatous plaques involves several steps.²⁵ The first step involves an inflammatory repair response of the injured arterial intima. Chronic minimal injury to the arterial endothelium is common and results from both physiologic and pathologic processes. Physiologic injury often occurs as the result of disturbed blood flow at bending points or bifurcations (branch points) in the artery. Endothelial injury or dysfunction also may be caused by hypercholesterolemia, oxidative stress, glycation end products in diabetes, irritants in tobacco smoke, circulating vasoactive amines, immune complexes, and infection.

Atheroma formation is initiated by adherence of monocytes to an area of injured or altered endothelium. Usually, monocytes do not adhere to intact endothelium; however, triggers of atherosclerosis such as a high saturated fat diet, smoking, hypertension, hyperglycemia, obesity, and insulin resistance initiate the expression of adhesion molecules by the endothelial cells, thus promoting attachment. The attached monocytes then migrate into the intima of the vessel and become macrophages. Lipids derived from plasma LDLs also enter through the injured or dysfunctional endothelium, forming extracellular deposits or small pools. Macrophages then engulf lipid molecules to become foam cells, which are characteristic features of the fatty streak. Foam cells are joined by T lymphocytes, and together they produce a variety of inflammatory cytokines, which promote the migration and proliferation of smooth muscle cells and collagen to surround the foam cells, thereby forming a fibrous covering or cap. The arrival of the smooth muscle cells triggers a coalescence of the foam cells and small extracellular pools of lipid into a larger pool or lipid core. The T lymphocytes secrete cytokines that inhibit the further production of collagen,

possibly leading to weakening and thinning of the fibrous cap and rendering it susceptible to rupture. With rupture or disruption of the plaque surface, tissue factor comes into contact with blood, and a thrombus is subsequently formed (Fig. 4.1).

Plaques may grow and proliferate outwardly, away from the lumen of the artery, or inwardly, into the lumen. With inward proliferation, the size of the lumen is progressively reduced (stenosis). Thus, blood flow may be chronically decreased, and when the demand for oxygen exceeds supply, the outcome is ischemic pain. Ischemic symptoms may be produced when occlusion reaches 75% of the cross-sectional area of the artery (Fig. 4.2). Of interest, however, in most instances of an acute coronary event, the vessels typically are less than 50% occluded by plaque growth.²⁶

Most acute coronary syndromes (ACSs, e.g., unstable angina [UA], MI) are caused by physical disruption or fracture of the vulnerable atheromatous plaque, most commonly of a plaque that did not cause extreme stenosis.²⁷ In plaque rupture, the fibrous cap tears, allowing arterial blood to enter the lipid core, where contact with tissue factor and collagen induces platelet adhesion and aggregation and activation of the coagulation cascade. This series of events results in clot or thrombus formation and sudden expansion of the lesion. Blood flow through the affected artery may become compromised or completely blocked.

Atherosclerosis usually is a focal disease that commonly occurs in certain areas or regions of arteries while sparing others. Those affected include the brain, heart, aorta, and peripheral arteries (Fig. 4.3). For example, the proximal left anterior descending coronary artery is a common area of atherosclerotic involvement; however, the internal mammary artery is rarely affected. The lumen of an affected artery may be circumferentially narrowed evenly or eccentrically, depending on the location and extent of the plaque.

The outcome of the atherosclerotic process is extremely variable. Some lesions never progress past the fatty streak phase; however, in most Western societies, the presence of frank plaques is the norm. Even so, most atheromatous plaques are not associated with clinical signs and symptoms and may never produce clinical manifestations.²⁵ Several factors may be responsible, including arterial remodeling, in which the plaque grows outward away from the lumen with a compensatory increase in the diameter of the vessel. In addition, collateral circulation may develop to compensate for diminished blood flow. For lesions that do produce symptoms, flow-limiting intact plaques typically precipitate symptoms such as chest pain (angina) when oxygen need exceeds demand, as during exercise. However, plaque rupture produces an acute or unstable clinical picture with signs and symptoms such as angina at rest, MI, or sudden death. Not all plaques have the same propensity to rupture, and risk depends on the physical and biochemical characteristics of the plaque.

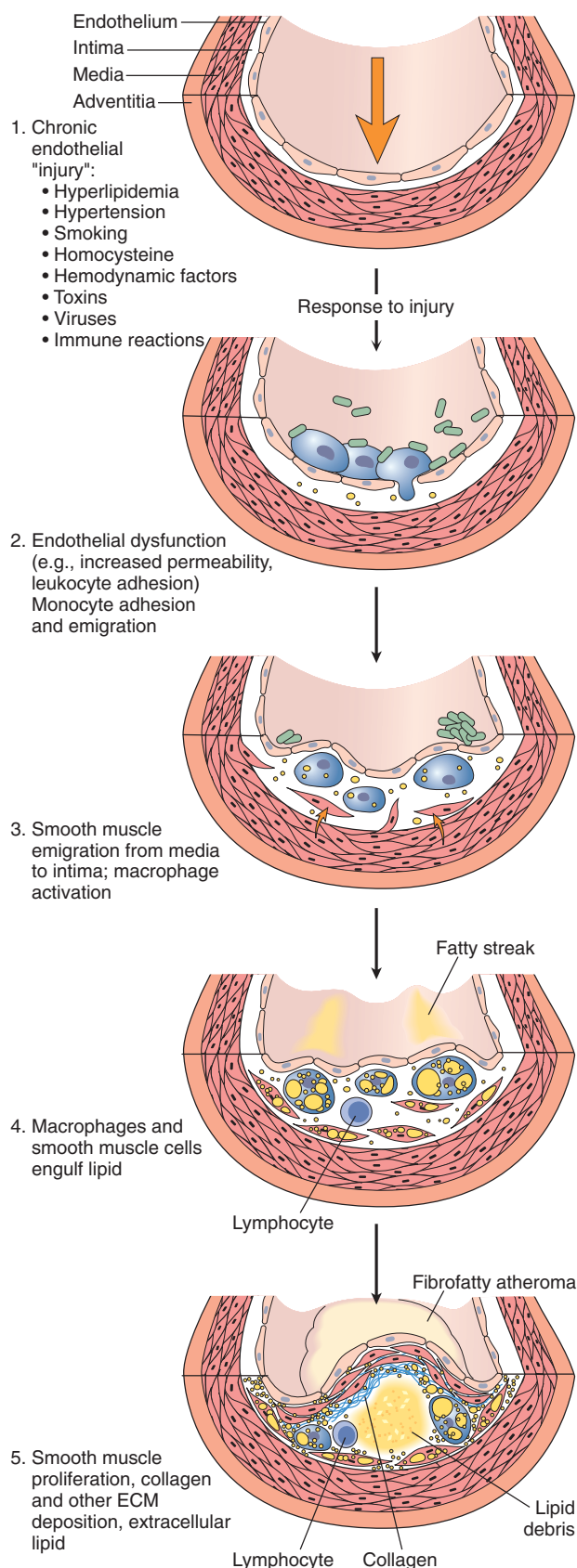

FIG 4.1 Evolution of arterial wall changes in the response to injury hypothesis. *ECM*, Extracellular matrix. (From Schoen FJ: Blood vessels. In Kumar V, et al, editors: *Robbins and Cotran pathologic basis of disease*, ed 8, Philadelphia, 2010, Saunders.)

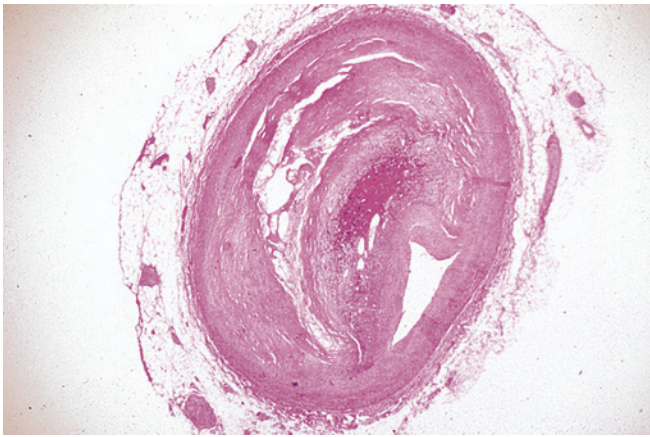

FIG 4.2 Photomicrograph of a cross-section of a coronary artery with severe stenosis and narrowing. (Courtesy of W. O'Conner, MD, Lexington, KY.)



FIG 4.3 The segment of aorta on the *left* demonstrates advanced atheromatous plaques, and the specimen on the *right* side is unaffected. (Courtesy of W. O'Conner, MD, Lexington, KY.)

Intraarterial complications of coronary atherosclerosis consist of luminal narrowing, intramural hemorrhage, thrombosis, embolism, and aneurysm. Intramural hemorrhage, which results from weakening of the intimal tissues, may lead to thrombosis. The localized blood also may serve as an irritant to precipitate a reflex reaction, resulting in spasm of the collateral vessels. Once formed, a thrombus may become encapsulated and may undergo fibrous organization and recanalization.

If the degree of ischemia that results from coronary atherosclerosis is significant and the oxygen deficit is prolonged, the area of myocardium supplied by that vessel may undergo necrosis. Reduced blood flow may result from thrombosis of the affected artery, a hypotensive episode, an increased demand for blood, or emotional stress. The infarct, or area of necrosis, may be subendocardial or transmural, the latter involving the entire thickness of the myocardium (Fig. 4.4). The extent of involvement is reflected in the electrocardiogram (ECG),

in which the ST segment is not elevated in cases with only partial obstruction to blood flow and limited myocardial necrosis, but elevation of the ST segment is seen in cases with more complete obstruction, profound ischemia, and a larger area of necrosis. Complications of MI include weakened heart muscle, resulting in acute congestive heart failure, postinfarction angina, infarct extension, cardiogenic shock, pericarditis, and arrhythmias. Causes of death in patients who have had an acute MI include ventricular fibrillation, cardiac standstill, congestive heart failure, embolism, and rupture of the heart wall or septum.¹

CLINICAL PRESENTATION

Symptoms

Chest pain is the most important symptom of coronary atherosclerotic heart disease. The pain may be brief, as in angina pectoris resulting from temporary ischemia of the myocardium, or it may be prolonged, as in unstable angina or acute MI. Ischemic myocardial pain results from an imbalance between the oxygen supply and the oxygen demand of the muscle. Atherosclerotic narrowing of the coronary arteries is an important cause of this imbalance. The exact mechanism or agents involved in producing the cardiac pain are not known.

Angina pectoris usually is described as a sensation of aching, heavy, squeezing pressure or tightness in the midchest region. The area of discomfort often is reported to be approximately the size of a fist and may radiate into the shoulder, left or right arm, neck, or lower jaw.²⁸ In rare cases, it may be present in only one of these distant sites, and the patient is free of central chest pain. The pain is of brief duration, lasting 5 to 15 minutes if the provoking stimulus is stopped or for a shorter time if nitroglycerin is used. *Angina* is defined in terms of its pattern of symptom stability. *Stable angina* is pain that is predictably reproducible, unchanging, and consistent over time. Pain typically is precipitated by exertion such as walking or climbing stairs but also may occur with eating or stress. Pain is relieved by cessation of the precipitating activity, by rest, or with the use of nitroglycerin. *Unstable angina* is defined as new-onset pain, pain that is increasing in frequency, increasing in intensity, precipitated by less effort than before, or occurring at rest. This pain is not readily relieved by nitroglycerin. The key feature is the changing character (increasing intensity) or pattern of the pain. Patients with stable angina have a relatively good prognosis. Patients with unstable angina have a poorer prognosis and often experience an acute MI within a short time. The term *acute coronary syndrome* describes a continuum of myocardial ischemia that ranges from unstable angina at one end to non-ST segment MI at the other. Differentiation requires diagnostic and laboratory testing. A relatively uncommon form of angina, Prinzmetal variant angina, occurs at rest and is caused by focal spasm of a coronary artery, usually with varied amounts of

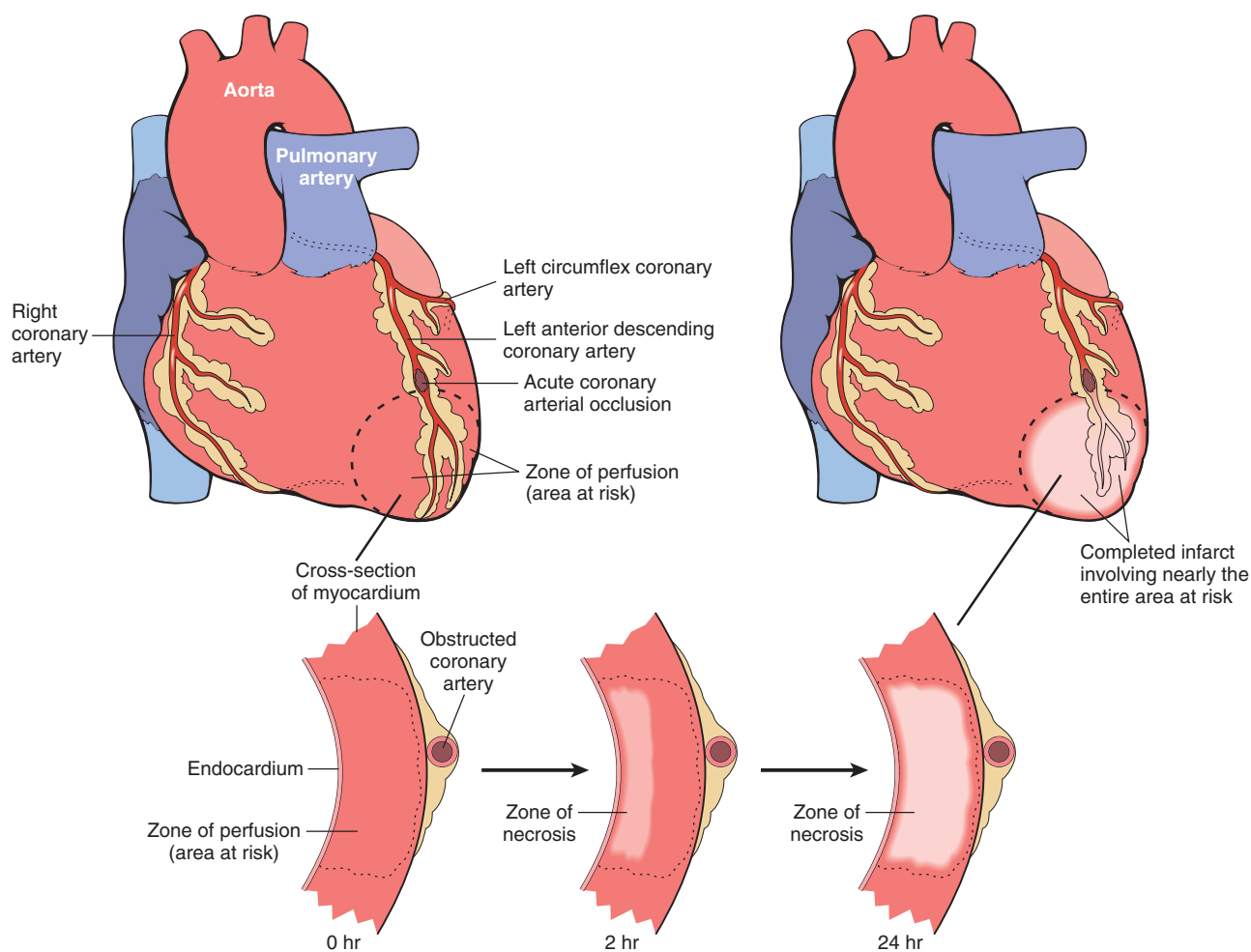

FIG 4.4 Progression of myocardial necrosis after coronary artery occlusion. (From Schoen FJ, Mitchell, RN: The heart. In Kumar V, et al, editors: *Robbins and Cotran pathologic basis of disease*, ed 8, Philadelphia, 2010, Saunders.)

atherosclerosis. Angina also may occur in persons with normal coronary vessels.

Patients with coronary atherosclerosis who experience prolonged pain as a result of myocardial ischemia usually have unstable angina or are having an acute MI. This pain usually is more severe and lasts longer than 15 minutes but has the same general character as that described for stable angina. Its location is the same as for the brief pain that results from temporary myocardial ischemia, and it may radiate in the same pattern into the shoulder, left or right arm, neck, or lower jaw and teeth.²⁹ Use of vasodilators or cessation of activity does not relieve the pain caused by infarction. Neither brief nor prolonged pain resulting from myocardial ischemia is aggravated by deep breathing. Of interest, women and men report different symptoms of MI, with fewer women experiencing chest pain but more often experiencing fatigue, dyspnea, and gastrointestinal complaints (e.g., heartburn).³⁰

Sudden cardiac death is estimated to account for 325,000 deaths annually in the United States and is often, but not always, caused by cardiac arrhythmia.³¹ Most

cardiac arrest survivors have structural heart disease; nearly 75% have coronary artery disease. Predominant symptoms and signs that most often precede sudden death include chest pain, cough, shortness of breath, diaphoresis, dizziness, fainting, fatigue, and palpitations (tachycardia). The most common cause of sudden death is ventricular fibrillation, a form of abnormal electrical activity resulting from interruption of the heart's electrical conduction system.

Palpitations of the heart (disagreeable awareness of the heartbeat) may be present in patients with coronary atherosclerotic heart disease with normal or abnormal rhythm. The complaint is not directly related to the seriousness of the underlying cardiac problem. Syncope, a transient loss of consciousness resulting from inadequate cerebral blood flow, also may occur in patients with coronary atherosclerotic heart disease.

Congestive heart failure can develop as a complication of coronary atherosclerotic heart disease and its sequelae include dyspnea, orthopnea, paroxysmal nocturnal dyspnea, edema, hemoptysis, fatigue, weakness, and cyanosis. Fatigue

and weakness may manifest early in the course of heart disease before the onset of congestive failure (see [Chapter 6](#)).

Signs

Clinical signs of coronary atherosclerotic heart disease are few, and the patient's clinical appearance may be entirely normal. Most clinical signs relate to other underlying cardiovascular disease or conditions such as congestive failure. Conditions such as corneal arcus and xanthoma of the skin are related to hyperlipidemia and hypercholesterolemia. Blood pressure may become elevated, and abnormalities in the rate and/or rhythm of the pulse may occur. Diminished peripheral pulses in the lower extremities may be noted, along with bruits in the carotid arteries. Panoramic radiographs of the jaws may occasionally demonstrate carotid calcifications, which are visible in the areas of vertebrae C3 and C4. These calcifications are risk markers of sustaining an adverse vascular event (MI, stroke) in the future.³² Retinal changes are common in hypertensive disease and diabetes mellitus. Signs associated with advanced coronary atherosclerotic heart disease usually reflect the presence of congestive heart failure. Distention of neck veins, peripheral edema, cyanosis, ascites, and enlarged liver may be noted.

LABORATORY AND DIAGNOSTIC FINDINGS

Blood tests are used in the evaluation of patients with symptoms of angina pectoris to screen for abnormalities that may contribute to or worsen coronary heart disease. These tests include a complete blood count to rule out anemia, thyroid function tests to exclude hyperthyroidism, renal function tests to exclude renal insufficiency, lipid screening for hypercholesterolemia, glucose screening for diabetes, homocysteine level determination, and CRP assay. Other diagnostic modalities that are specific for coronary heart disease include resting ECG, chest x-ray studies, exercise stress testing, ambulatory (Holter) electrocardiography, stress thallium-201 perfusion scintigraphy, exercise echocardiography, ambulatory ventricular function monitoring, and cardiac catheterization and coronary angiography.

To establish the diagnosis of acute MI and to determine the extent of the infarction, serum enzyme determinations are necessary along with the physical examination and diagnostic testing (ECG and echocardiogram) findings.³³ Cardiac serum biomarkers of acute MI include troponin I, troponin T, creatine kinase isoenzyme (CK-MB), and myoglobin. The troponins and CK-MB are enzymes released only when cell death (infarction) or injury occurs. Troponins are proteins derived from the breakdown of myocardial sarcomeres. Troponin assays are the most sensitive and specific in differentiating cardiac muscle damage from trauma to skeletal muscle or other organs and are virtually absent in the plasma of normal persons and are found only after cardiac injury. Troponins are first detectable 2 to 4 hours after the onset of an acute

MI; they are maximally sensitive at 8 to 12 hours, peak at 10 to 24 hours, and persist for 5 to 14 days.^{34,35}

CK-MB is another enzymatic marker of cardiac cell injury with characteristics similar to those of the troponins; however, CK-MB is also found after injury to skeletal muscle and other tissues. Despite this relative lack of specificity, elevated levels of CK-MB usually are considered to be the result of an MI. CK-MB is detectable within 3 to 4 hours after infarction; it reaches peak values at 12 to 24 hours and persists for 2 to 4 days.³⁵ In many cardiac centers, troponin assay has replaced CK-MB determination as the diagnostic test of choice for MI because of its sensitivity and specificity and as a result of cost issues. In any case, definitive diagnosis of MI requires serial testing (every 6 to 8 hours) over several days, rather than reliance on single test results. Testing for levels of B-natriuretic peptide, which is produced largely by the left ventricle, also aids in determining the extent of ventricular damage and the prognosis of heart failure.

MEDICAL MANAGEMENT

Angina Pectoris

Medical management of a patient with chronic stable angina consists of an array of interventions:

- Identification and treatment of associated diseases that can precipitate or worsen angina
- Reduction in risk factors for cardiovascular disease
- Behavioral modifications and lifestyle interventions
- Pharmacologic management
- Revascularization by percutaneous catheter-based techniques or by coronary artery bypass surgery ([Box 4.1](#))

Management may include general lifestyle measures such as an exercise program; weight control; restriction

BOX 4.1 Medical Management of Patients With Stable Angina Pectoris

- Identification and treatment of associated diseases that can precipitate or worsen angina (anemia, obesity, hyperthyroidism, sleep apnea)
- Reduction in risk factors for cardiovascular disease (hypertension, smoking, hyperlipidemia)
- Behavioral modification and lifestyle intervention (weight loss, exercise)
- Pharmacologic management
 - Nitrates
 - Beta-blockers
 - Calcium channel blockers
 - Antiplatelet agents
- Revascularization
 - Percutaneous transluminal coronary angioplasty with stenting
 - Coronary artery bypass grafting

of salt, cholesterol, and saturated fatty acids; cessation of smoking; and control of exacerbating conditions such as anemia, hypertension, and hyperthyroidism. Patients who have significant angina are encouraged to avoid long hours of work, take rest periods during the working day, obtain adequate rest at night, use mild sedatives, take frequent vacations, and, in some cases, change their occupation or retire. Patients should avoid known precipitating factors that may bring on cardiac pain, such as cold weather, hot and humid weather, big meals, emotional upset, cigarette smoking, and certain drugs and stimulants (e.g., amphetamines, caffeine, ephedrine, cyclamates, alcohol).

Drug therapy consists of nitrates (nitroglycerin or long-acting nitrates), antiplatelet agents, statins, β -adrenergic blockers, calcium channel blockers (CCBs), and angiotensin-converting enzyme (ACE) inhibitors (Table 4.1).³⁶ Nitrates

are vasodilators, predominantly venodilators, and are a cornerstone of the pharmacologic management of angina. By action of vasodilation, they decrease cardiac load, resulting in decreased oxygen demand and hypotension. Nitrates also may alleviate coronary artery spasm. Nitroglycerin may be used acutely for the relief of anginal pain and prophylactically to prevent angina. It comes in a variety of forms, including tablets, lingual sprays, ointments, and transdermal patches. Nitroglycerin tablets are placed under the tongue to dissolve; the spray can be administered beneath the tongue or onto the oral mucosa. Nitrates are taken orally to prevent anginal symptoms and are supplied in tablet form, as an ointment for topical application, or as long-acting transdermal nitrate patches that are applied to the skin. Nitrates are used to reduce symptoms of angina, but they do not slow, alter, or reverse the progression of coronary artery disease.

TABLE 4.1 Drugs Used in the Management of Angina

Drug	Oral Adverse Effects	Dental Considerations
NITRATES		
Dilatrate-SR, nitroglycerin, Nitrogard, Imdur, Ismo, isosorbide dinitrate, Isordil, isosorbide 5-mononitrate, Minitran, Monoket, Nitrogard, Nitrolingual, Nitro-Bid, Nitro-Dur, Nitrek, Nitrol, Nitrostat, Nitro-Tab, Nitro-Time	Dry mouth	Orthostatic hypotension, headache Vasoconstrictor interactions: none
BETA-BLOCKERS		
Nonselective: Blockade of β_1 and β_2 Receptors		
Carteolol (Cartrol), nadolol (Corgard), penbutolol (Levitol), pindolol (Visken), Propranolol/LA (Inderal), sotalol (Betapace), timolol (Blocadren)	Taste changes, lichenoid reactions	Orthostatic hypotension. Vasoconstrictor interactions: increase in BP possible with sympathomimetics, cautious use recommended (maximum, 0.036 mg epinephrine; 0.20 mg levonordefrin)
Cardioselective: Blockade of β_1 Receptors Only		
Metoprolol/XL (Lopressor), Atenolol (Tenormin), Acebutolol (Sectral), Labetalol (Normodyne, Trandate)		Vasoconstrictor interactions: minimal effect with sympathomimetics; normal use
CALCIUM CHANNEL BLOCKERS		
Bepidil (Vascor), diltiazem/CD (Cardizem, Cartia, Dilacor, Diltia, Taztia, Tiazac), felodipine (Plendil), isradipine (DynaCirc), nifedipine/PA/XL (Adalat, Nifedical, Procardia), verapamil/SR (Calan, Isoptin, Verelan, Covera), amlodipine (Norvasc), nicardipine/SR (Cardene), nisoldipine (Sular), nitrendipine	Gingival overgrowth, dry mouth, lichenoid eruptions (rare)	None. Vasoconstrictor interactions: none
PLATELET AGGREGATION INHIBITORS		
Aspirin	None	Increased bleeding, but not clinically significant with daily doses ≤ 325 mg. Vasoconstrictor interactions: none
Clopidogrel (Plavix)	None	Increased bleeding time. Vasoconstrictor interactions: none

BP, Blood pressure.

Beta-blockers, which are effective in the treatment of many patients with angina, compete with catecholamines for β -adrenergic receptor sites, resulting in decreased heart rate and myocardial contractility and reducing myocardial oxygen demand. Whereas nonselective beta-blockers block the β_1 and β_2 receptors, cardioselective beta-blockers preferentially block the β_1 receptors at normal therapeutic doses. Nonselective beta-blockers may cause unwanted effects, such as increasing the tone of vascular smooth muscle and causing both vasoconstriction of peripheral vessels and contraction of bronchial smooth muscle. Thus, nonselective beta-blockers are not prescribed for patients with a history of asthma. Injections of sympathomimetic drugs such as epinephrine or levonordefrin may result in elevation of blood pressure in patients taking nonselective beta-blockers; therefore, caution is indicated in use of these agents.

Calcium channel blockers are effective in the treatment of chronic stable angina when given alone or in combination with beta-blockers and nitrates. These drugs decrease intracellular calcium, resulting in vasodilation of coronary, peripheral, and pulmonary vasculature, along with decreased myocardial contractility and heart rate.

The statins inhibit 3-hydroxy-3-methylglutaryl-coenzyme A reductase (HMG-CoA) in the liver, thereby leading to enhanced expression of the LDL receptors that capture blood cholesterol. They are used to lower LDL cholesterol and increase HDL cholesterol and have been shown to decrease the risk for a major coronary event and the risk of death.³⁷ Statins also are antiinflammatory.

Angiotensin-converting enzyme inhibitors are indicated for use in patients with coronary heart disease who also have diabetes, left ventricular dysfunction, or hypertension.³⁷ The benefit of these agents appears to be primarily due to their antihypertensive effects. Angiotensin receptor blockers (ARBs) are used in patients who are intolerant to ACE inhibitor drug use.

Antiplatelet therapy with aspirin is another cornerstone of treatment in patients with angina.³⁷ Regular use of aspirin in patients with stable angina is associated with a significant reduction in fatal events, and in patients with unstable angina, aspirin decreases the chances of fatal and nonfatal MI. Aspirin, in daily doses of 75 to 325 mg, is recommended for all patients with acute and chronic ischemic heart disease, regardless of the presence or absence of symptoms.³⁷ Clopidogrel, another antiplatelet agent, has been shown to have effects equivalent to those of aspirin; it is used in place of or in combination with aspirin. Ticlopidine and dipyridamole have not been shown to have any beneficial effects and are not recommended for use.

Revascularization is an option for patients with stable or unstable angina. Available procedures for revascularization include percutaneous transluminal coronary angioplasty, stents, and coronary artery bypass grafting. Percutaneous transluminal coronary angioplasty, also known as balloon angioplasty, involves the use of a small,

inflatable balloon catheter over a thin guidewire that is threaded through the occluded segment of the artery. Once in place, the balloon is inflated and compresses the plaque and thrombus against the arterial wall, with consequent enlargement of the lumen of the vessel (Fig. 4.5). Widening of the lumen results in an immediate increase in blood flow and provides symptomatic relief for ischemia. However, stenosis recurs within 6 months in 10% to 50% of patients, along with a return of symptoms.²⁶

One method of decreasing the occurrence of restenosis with percutaneous transluminal coronary angioplasty involves the use of a thin, expandable, metallic mesh stent positioned by the balloon and expanded against the plaque and vessel wall, then left in place. The stent functions as a permanent scaffold to help maintain vessel patency (Fig. 4.6). The use of stents has decreased the incidence of restenosis to about 20% to 30%; however, it has not prevented restenosis from occurring.³⁸ Currently, three types of stents are used: bare metal, drug eluting and, bioresorbable. The bare metal stents maintain mechanical patency; however, they do not prevent endothelial proliferation that results in restenosis. Drug-eluting stents are coated with antiproliferative agents that are very effective in controlling restenosis. Drug-eluting stents carry an increased risk for thrombosis for up to 1 year; therefore these patients require long-term use of aspirin, clopidogrel, or both. Bioresorbable stents have recently been approved by the Food and Drug Association.

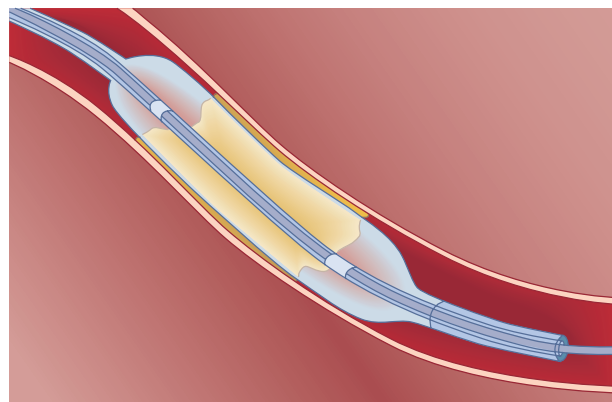

FIG 4.5 Balloon angioplasty catheter. (From Teirstein PS: Percutaneous coronary interventions. In Goldman L, Ausiello D, editors: *Cecil textbook of medicine*, ed 23, Philadelphia, 2008, Saunders.)

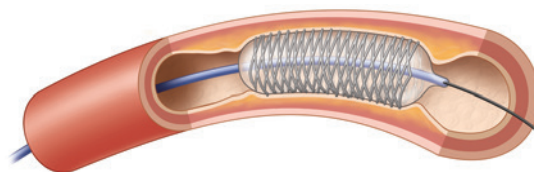

FIG 4.6 Expandable metallic stent. The stent is left in place after deflation and withdrawal of the balloon catheter.

Other non-balloon angioplasty methods are rotational atherectomy and the use of lasers. With percutaneous intervention, a successful outcome is achieved in more than 95% of patients, with very few complications.³⁸

Coronary artery bypass graft (CABG) surgery is an effective means of controlling symptoms in the management of unstable angina; it can improve the long-term survival rate in certain subsets of patients. It also is effective in controlling symptoms in patients whose pain persists despite medical control. With CABG, a segment of artery or vein is harvested or released from a donor site; it is then grafted to the affected segment of coronary artery, thus bypassing the area of occlusion (Fig. 4.7). Two primary graft donor sites are used: the saphenous vein from the leg and the internal mammary artery from the chest. Of the two, the internal mammary artery graft is sturdier and much less susceptible to graft atherosclerosis and occlusion than are vein grafts. Within 10 years postoperatively, 30% of saphenous vein grafts become occluded, but internal mammary artery grafts are much more resistant to occlusion. The arterial grafts are preferred for first bypass procedures when possible. Reoperation

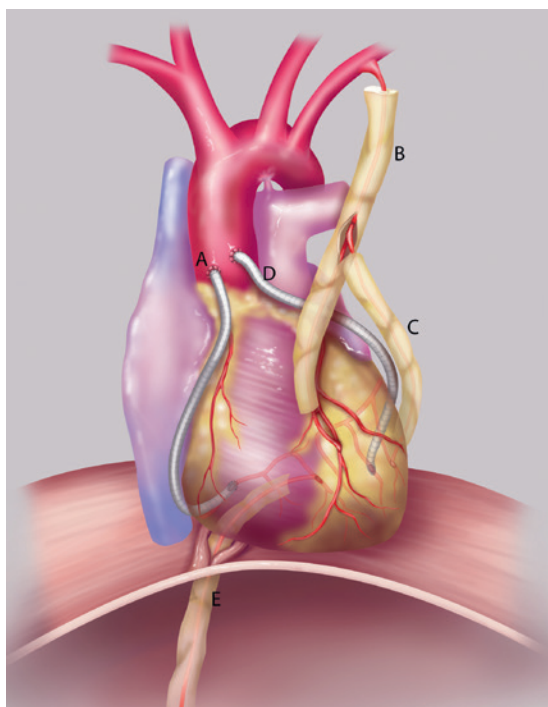

FIG 4.7 Types of bypass grafts. Bypass grafts include reversed saphenous vein graft from aorta to right coronary artery **A**, in situ left internal mammary artery graft to anterior descending coronary artery **B**, Y graft of right internal mammary artery from left internal mammary artery to circumflex coronary artery **C**, radial artery graft from the aorta to the circumflex coronary artery **D**, and in situ gastroepiploic graft to the posterior descending branch of the right coronary artery **E**. (Adapted from Lytle BW: Surgical treatment of coronary artery disease. In Goldman L, Ausiello D, editors: *Cecil textbook of medicine*, ed 23, Philadelphia, 2008, Saunders.)

is difficult because of surgical site scarring and the limited supply of graft donor material. The perioperative mortality rate for primary elective CABG procedures is less than 1%.³⁸

Myocardial Infarction

Patients who experience an acute MI should receive emergency treatment and should be hospitalized as soon as possible (Box 4.2). If the condition involves sudden cardiac arrest and loss of consciousness, basic life support should be provided that involves properly patient positioning, keeping the blood pumping and the airway open, and air exchange to the lungs (see Appendix A). Early administration of oxygen, nitrates, and aspirin is recommended. Oxygen is provided by nasal cannula to enhance oxygen saturation of the blood and keep the heart workload at a minimum level; nitrates are provided to reduce cardiac preload; and 81 to 325 mg of aspirin is chewed and swallowed by the conscious patient, which decreases platelet aggregation and limits thrombus formation. Use of an automated external defibrillator (AED) may also be required if a shockable rhythm is identified.³⁴

The basic management goal of the medical team is to relieve the ischemia, minimize the size of the infarction, and prevent death from lethal arrhythmias. The size and extent of the infarct are critical determinants of the outcome. Definitive treatment for patients with acute MI

BOX 4.2 Medical Management of Patients With Acute Myocardial Infarction

- Rapid hospitalization and determination of ST segment changes
- Aspirin administration
- Early thrombolytic therapy (for patients with ST segment elevation only)
 - Streptokinase
 - Alteplase
 - Reteplase
 - Tenecteplase
- Early revascularization
 - Thrombolysis (for patients with ST segment elevation only)
 - Percutaneous transluminal coronary angioplasty with stenting
 - Coronary artery bypass grafting
- Pharmacologic therapy
 - Antiplatelet drugs (glycoprotein IIa/IIIb inhibitor, aspirin, clopidogrel)
 - Nitrates
 - β -Adrenergic blockers
 - Calcium channel blockers
 - Angiotensin-converting enzyme inhibitors
 - Lipid-lowering drugs
 - Anticoagulants (unfractionated heparin, low-molecular-weight heparin)
 - Morphine
 - Sedative-hypnotics
- Oxygen

depends on the extent of ischemia as reflected on the ECG, which shows the presence or absence of ST segment elevation (Fig. 4.8). An MI without ST segment elevation (non-STEMI) is caused by partial blockage of coronary blood flow. An MI with ST segment elevation (STEMI) is caused by complete blockage of coronary blood flow and more profound ischemia involving a relatively large area of myocardium. This distinction is clinically important because early fibrinolytic therapy improves outcomes in STEMI but not in non-STEMI.^{26,34} Also, morphine use for pain relief is recommended for STEMI; however, use of morphine in non-STEMI patients is associated with

increased mortality rate and should be avoided in these patients.^{39,40}

The management of acute MI has undergone significant change over the past several years with the recognition that early recanalization with thrombolytic therapy or percutaneous coronary intervention (PCI) can result in significant reduction in morbidity and mortality associated with STEMI. The greatest benefit is realized when patients receive thrombolytic drugs within the first 3 hours after infarction, and current guidelines recommend that PCI be provided within 90 minutes of first medical contact.⁴⁰ Early use of thrombolytic drugs may decrease the extent

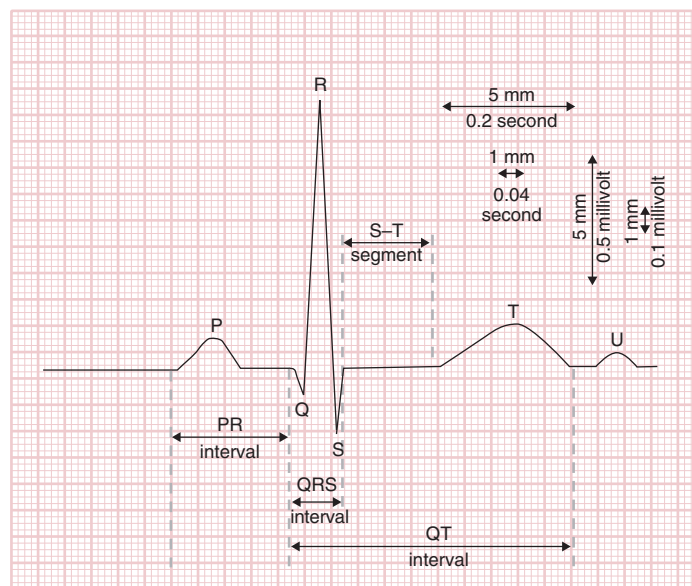

A

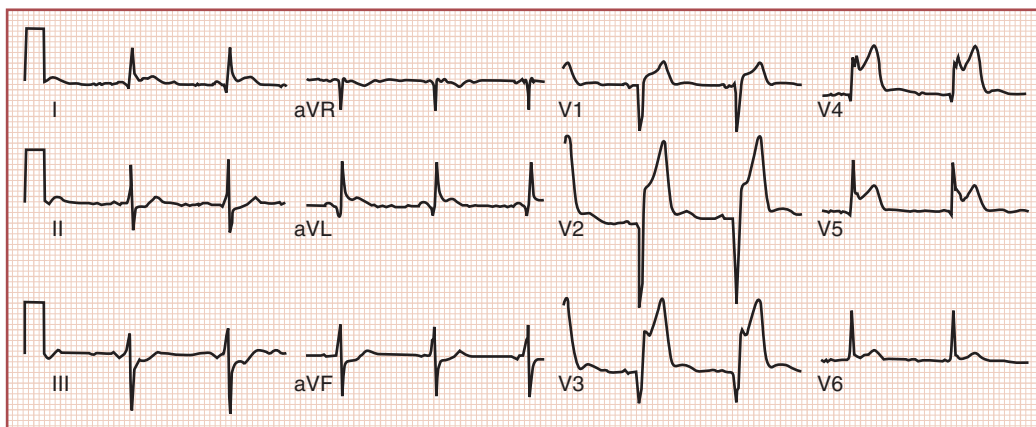

B

FIG 4.8 A, Waves and intervals on a normal electrocardiogram (ECG). The ST segment characteristically lies only very slightly above the baseline tracing. **B**, Electrocardiographic tracing shows an acute anterior/lateral myocardial infarction. ST segment elevation is evident in leads I, aVL, and V₁ to V₆. (A, From Ganz L, Curtiss E: *Electrocardiography*. In Goldman L, Ausiello D, editors: *Cecil textbook of medicine*, ed 23, Philadelphia, 2008, Saunders. B, Courtesy Dr. Thomas Evans. From Anderson JL: ST-elevation acute myocardial infarction and complications of myocardial infarction. In Goldman L, Ausiello D, editors: *Cecil textbook of medicine*, ed 23, Philadelphia, 2008, Saunders.)

of necrosis and myocardial damage and dramatically improve outcome and prognosis. Thrombolytic (or fibrinolytic) drugs used in the treatment of acute MI include streptokinase (SK), alteplase (tissue plasminogen activator [t-PA]), reteplase (r-PA), and tenecteplase (t-PA). For most patients with STEMI, the preferred method for revascularization is percutaneous coronary angioplasty. In patients with STEMI, non-STEMI, or unstable angina (ACS), anticoagulation often is effected with unfractionated heparin or low-molecular-weight heparin (LMWH); in addition, glycoprotein IIa/IIIb inhibitors (abciximab, eptifibatid, tirofiban) are administered intravenously for their antiplatelet effects. General pharmacologic measures for patients with acute MI include the use of sedatives and anxiolytic medications, nitrates, beta-blockers, CCBs, ACE inhibitors, lipid-lowering agents, oxygen if needed, along with bedrest. Antiplatelet drugs (i.e., aspirin in daily doses of 75 to 325 mg, clopidogrel, prasugrel, ticlopidine, and ticagrelor) are used for ACS to reduce risk of morbidity and mortality. Alternatively, anticoagulants (LMWH, factor Xa inhibitors, or direct oral anticoagulants) may be used.⁴⁰

The development of an arrhythmia in a patient who has had an acute MI constitutes an emergency that must be treated aggressively with antiarrhythmic drugs. During the first several weeks after an infarction, the conduction system of the heart may be unstable, and patients are prone to serious arrhythmias and reinfarction. A pacemaker may be used in patients who have severe myocardial damage and resultant heart failure.

DENTAL MANAGEMENT

Medical Considerations

Identification. Any patient whose condition remains undiagnosed but has cardinal clinical or radiographic signs or symptoms of ischemic heart disease should be referred to a physician for diagnosis and treatment. The dentist must be able to distinguish a patient who has stable versus unstable angina versus MI. In the former, the chest pain is characteristically by a consistent, recurring, and unchanging pattern brought on by exertion or stress that typically subsides within 5 to 15 minutes with rest or use of nitroglycerin. Unstable angina causes a worsening chest pain with a pattern of increasing severity, frequency, or duration. If pain is unremitting after 15 minutes, an MI should be assumed. Laboratory testing and diagnostic imaging are helpful in identifying those who have varying severity of ischemic heart disease.

Risk Assessment. Assessment of risk for the dental management of patients with ischemic heart disease involves three determinants:

1. Severity of the disease
2. Stability and cardiopulmonary reserve of the patient (i.e., the ability to tolerate dental care)
3. Type and magnitude of the dental procedure

All must be factored into a dental management plan so that a rational and safe decision can be made—specifically, to determine whether a patient can safely tolerate a planned procedure. The American College of Cardiology (ACC) and the American Heart Association (AHA)^{41,42} have published risk stratification guidelines for patients with various types of heart disease who are undergoing noncardiac surgical procedures. These guidelines provide a framework for determination of associated risk for surgical as well as for nonsurgical dental procedures (Boxes 4.3 and 4.4). For example, recent MI (within the past 7 to 30 days) and unstable angina are classified as clinical predictors of major risk for perioperative complications. By contrast, a past history of ischemic heart disease (i.e., stable [mild] angina and past history of MI) is considered one of the intermediate risk factors for perioperative complications. Accordingly, a past history of ischemic heart disease with no other clinical risk factors, as shown in Box 4.3, is unlikely to be associated with significant risk for an adverse event during dental procedures.

The type and magnitude of the planned procedure also must be considered. On the basis of these guidelines, extensive oral and maxillofacial surgical procedures, and perhaps some of the more extensive periodontal surgical procedures, would fall into the intermediate cardiac risk category under “head and neck procedures,” with a 1% to 5% risk. Minor oral surgery and periodontal surgery would fall within the low-risk, “superficial surgery” or “ambulatory surgery” category, with less than 1% risk. Although not included in the list, nonsurgical dental procedures are likely to carry even less of a risk, considering that local anesthesia is used, minimal blood loss is anticipated, and procedures typically are of short duration. Procedures that are performed with the patient under general anesthesia and have the potential for significant blood and fluid loss with resultant adverse hemodynamic effects pose the highest risk.

The final element included in the AHA/ACC Guidelines is the ability of the patient to perform basic physical tasks.⁴¹ The energy expended in performing these tasks is measured in metabolic equivalents of tasks (METs), which is a measure of oxygen consumption. Studies have shown that a person who cannot perform at a minimum of a 4 MET level is at increased risk for a cardiovascular event. Climbing a flight of stairs requires a 4-MET effort; thus, a person who cannot climb a flight of stairs without chest pain or shortness of breath is at increased risk.

These medical risk stratification guidelines should be applied in the context of the planned dental procedures. For example, a patient with unstable angina or recent MI is assigned to the major cardiac risk category. It also is likely that this person would have difficulty climbing a flight of stairs. By contrast, if the planned dental procedure is limited to routine clinical examination with radiographs (extremely low risk category), and the patient is stable and not anxious, the risk for an adverse occurrence is minimal; thus, alterations in the dental management

BOX 4.3 Clinical Predictors of Increased Perioperative Cardiovascular Risk: Myocardial Infarction, Heart Failure, or Death

Major Clinical Risk Factors

- Unstable coronary syndromes
 - Acute or recent MI* associated with important ischemic risk as indicated by clinical signs and symptoms or by noninvasive study
 - Unstable or severe angina (Canadian class III or IV)[†]
- Decompensated heart failure (NYHA class 4: worsening or new-onset heart failure)
- Significant arrhythmias
 - High-grade AV block
 - Mobitz type 2 AV block
 - Third-degree AV block
 - Symptomatic ventricular arrhythmias in the presence of underlying heart disease
 - Supraventricular arrhythmias with uncontrolled ventricular rate
 - Symptomatic bradycardia
 - Newly recognized ventricular tachycardia
- Severe valvular disease
 - Severe aortic stenosis
 - Symptomatic mitral stenosis

Intermediate Clinical Risk Factors

- History of ischemic heart disease
- History of compensated or previous heart failure
- History of cerebrovascular disease
- Diabetes mellitus
- Renal insufficiency

Minor Clinical Risk Factors

- Advanced age (>70 years)
- Abnormal ECG (left ventricular hypertrophy, left bundle branch block, ST-T wave abnormalities)
- Rhythm other than sinus (e.g., atrial fibrillation)
- Uncontrolled systemic hypertension ($\geq 180/110$ mm Hg)

AV, Atrioventricular; ECG, electrocardiogram; NYHA, New York Heart Association.

*The American College of Cardiology National Database Library defines recent myocardial infarction (MI) as occurring after 7 days but within 1 month (at or before 30 days) before the procedure and acute MI as occurring within 7 days.

[†]May include "stable" angina in patients who are unusually sedentary.

[‡]Data from Campeau L: Grading of angina pectoris, *Circulation* 54:522-523, 1976. The Canadian classification is a system of grading angina severity (grades I to IV), with grade I angina occurring only with strenuous exertion and grade IV angina occurring with any physical activity or at rest.

Data from Fleisher LA, Beckman JA, Brown KA, et al: ACC/AHA 2007 guidelines on perioperative cardiovascular evaluation and care for noncardiac surgery: executive summary: a report of the American College of Cardiology/American Heart Association Task Force on Practice Guidelines (Writing Committee to Revise the 2002 Guidelines on Perioperative Cardiovascular Evaluation for Noncardiac Surgery). *Circulation* 116:1971-1996, 2007.

BOX 4.4 Cardiac Risk Stratification for Noncardiac Surgical Procedures

High (Reported Cardiac Risk Often >5%)

- Aortic and other major vascular surgery

Intermediate (Reported Cardiac Risk Generally <5%)

- Intraperitoneal and intrathoracic surgery
- Carotid endarterectomy
- Head and neck surgery
- Orthopedic surgery
- Prostate surgery

Low (Reported Cardiac Risk Generally <1%)

- Endoscopic procedures
- Superficial procedures
- Cataract surgery
- Breast surgery
- Ambulatory surgery

*Combined incidence of cardiac death and nonfatal myocardial infarction.

Adapted from Fleisher LA, Beckman JA, Brown KA, et al: ACC/AHA 2007 guidelines on perioperative cardiovascular evaluation and care for noncardiac surgery: executive summary: a report of the American College of Cardiology/American Heart Association Task Force on Practice Guidelines (Writing Committee to Revise the 2002 Guidelines on Perioperative Cardiovascular Evaluation for Noncardiac Surgery). *Circulation* 116:1971-1996, 2007.

approach would be unnecessary. If, however, a patient with stable angina or a past history of MI (intermediate risk category) with minimal cardiac reserve is scheduled for multiple extractions and implant placement (low to intermediate risk category), the risk for an adverse perioperative event is more significant, and a more complex dental management plan may be required. Also, dentists should be aware that patients who have ischemic heart disease with concurrent valvulopathy and low ejection fraction (<50%) may be at higher risk for major adverse outcomes when invasive procedures are performed.⁴³

Readers should be aware of risk calculators now available to help predict the likelihood of a major adverse cardiac event (MACE) associated with noncardiac surgical procedures.⁴³

Recommendations. Based on the assessment of medical risk, the type of planned dental procedure, and the stability and anxiety level of the patient, general management strategies for patients with stable angina or a past history of MI without ischemic symptoms (intermediate risk category) and no other risk factors should include the following: short appointments in the morning, comfortable chair position, reduced stress environment with oral sedation or nitrous oxide–oxygen sedation, pretreatment vital signs, availability of nitroglycerin, profound local anesthesia, limited amount of vasoconstrictor, avoidance of epinephrine-impregnated retraction cord, and effective postoperative pain control (Box 4.5).

For patients with symptoms of unstable angina or those who have had an MI within the past 30 days (major risk

BOX 4.5 Dental Management Considerations for Patients With Stable (Mild) Angina or Past History of Myocardial Infarction More Than 30 Days, Without Ischemic Symptoms

P Patient Evaluation and Risk Assessment		C	
Potential Issues and Concerns		D	
A		E	
Antibiotics	No issues. Patients with ischemic heart disease, coronary artery stents, or CABG surgery do <i>not</i> require antibiotic prophylaxis.	Capacity to tolerate care	Patients who have stable angina that is relieved by nitrates can receive routine dental care. Have nitroglycerin available.
Analgesics	Ensure adequate postoperative pain control.	Chair position	Ensure a comfortable chair position and avoid rapid position changes.
Anesthesia	Avoid use of excessive amounts of epinephrine; limit to 2 carpules of 1:100,000 epinephrine at a time (within 30–45 minutes); greater quantities may be tolerated well but increase risk.	Drugs	Use of excessive amounts of epinephrine with nonselective beta-blockers can potentially cause a spike in blood pressure and appears to be dose dependent; avoid the use of epinephrine-impregnated retraction cord.
Anxiety	Use stress reduction protocol (see Chapter 1). Consider the use of preoperative oral sedation (short-acting benzodiazepine) 1 hour before procedure, as well as using N ₂ O-O ₂ inhalational sedation intraoperatively.	Devices	Patients who have coronary artery stents do not require antibiotic prophylaxis.
B		F	
Bleeding	If the patient is taking aspirin or other antiplatelet medication, anticipate some increased bleeding, but modification of drug regimen is not required.	Equipment	Consider taking preoperative vital signs and the use of a pulse oximeter if oral sedation is used or if the patient becomes symptomatic.
Breathing	No issues	Emergencies	Precipitation of an angina attack, MI, arrhythmia, or cardiac arrest is possible. Have nitroglycerin readily available as well as oxygen. Be prepared to perform basic life support (activate EMS, provide CPR, use AED, if needed).
Blood pressure	Monitor blood pressure.	Follow-up	Ensure that patient is maintaining regular follow-up visits with his or her physicians.

AED, Automated external defibrillator; CABG, coronary artery bypass graft; CPR, cardiopulmonary resuscitation; EMS, emergency medical services; MI, myocardial infarction.

category), elective care should be postponed ([Box 4.6](#)).^{44,45} If treatment becomes necessary, it should be performed as conservatively as possible and directed primarily toward pain relief, infection control, or the control of bleeding, as appropriate. Consultation with the physician is advised. Additional management recommendations may include establishing and maintaining an intravenous line, continuously monitoring the ECG and vital signs, using a pulse oximeter, and administering nitroglycerin prophylactically just before the initiation of treatment.⁴⁶ These measures may require that the patient be treated in a special patient care facility or hospital dental clinic.

Antibiotics: Infection Risk. For patients who have coronary heart disease, a coronary artery stent, or have undergone a CABG procedure, antibiotic prophylaxis is not recommended.⁴⁷

Bleeding. Patients who take daily aspirin or other antiplatelet agents (e.g., clopidogrel) can expect some increase in surgical and postoperative bleeding, but this is generally not clinically significant and can be controlled with local measures only. Discontinuation of these agents before dental treatment generally is unnecessary and can increase the risk of thrombosis, MI, or death.^{48,49} Patients who are taking warfarin for anticoagulation can safely

undergo dental or surgical procedures, provided that the international normalized ratio (INR) is 3.5 or less (see [Chapter 24](#)).⁵⁰ The INR results should be performed within 24 to 72 hours within the scheduled invasive procedure depending on the level of INR stability.

Capacity to Tolerate Care. This determination should be based on the presence, severity, and stability of ischemic symptoms, as well as the proximity of the most recent ACS event. Patients who have *stable angina* pose an intermediate cardiac risk and can receive routine dental care when attention to is provided to minimize risk. In contrast, patients who have *unstable angina* should be considered to be at major cardiac risk and are not candidates for elective dental care. Asking the patient if the chest pain occurs at rest or during sleep, a particularly ominous sign, is helpful in distinguishing this condition.

Patients who have had an MI in the past may or may not have ischemic symptoms. For an asymptomatic patient with no other risk factors, the risk for an adverse event is minimal, especially one month or more after the MI. If, however, symptoms such as chest pain, shortness of breath, dizziness, or fatigue are present, or the MI was less than one month, then the patient falls in the major

BOX 4.6 Dental Management Considerations for Patients With Unstable Angina or History of Recent Myocardial Infarction (Within Past 30 Days)
A**Awareness**

There is risk for cardiac arrest in these patients; appropriate precautions are advised.

P**Patient Evaluation and Risk Assessment**

- Avoid elective dental care.
- If care becomes necessary, consult with a physician to develop a treatment plan.
- The patient is best treated in a hospital dental clinic or special care facility.

Potential Issues and Factors of Concern**A**

Antibiotics	No issues. Patients with coronary artery stents or CABG surgery do <i>not</i> require antibiotic prophylaxis.
Analgesics	Ensure adequate postoperative pain control.
Anesthesia	Avoid use of vasoconstrictor if possible. If vasoconstrictor is needed, limit to 2 carpules of 1 : 100,000 epinephrine at a time (within 30–45 minutes); greater quantities may be tolerated but increase risk. May need to discuss use with physician.
Anxiety	Use stress reduction protocol (see Chapter 1). Consider use of preoperative oral sedation (short-acting benzodiazepine) 1 hour before procedure, as well as using N ₂ O-O ₂ inhalational sedation intraoperatively.

B

Bleeding	If patient is taking aspirin or other antiplatelet medication, anticipate some excessive bleeding, but modification of drug regimen is not required.
Breathing	No issues

Blood pressure	Continuous monitoring of blood pressure and pulse is recommended.
----------------	---

C

Capacity to tolerate care	Defer care if patient has unstable angina; refer to physician. Defer care of patient who has a history of MI that occurred <1 month or if the patient has chest pain–related symptoms.
Chair position	If urgent care is required, ensure a comfortable chair position and avoid rapid position changes.

D

Drugs	Consider administering prophylactic nitroglycerin just before procedure. Provide continuous oxygen by nasal cannula or nasal mask. Use of excessive amounts of epinephrine with nonselective beta-blockers can potentially cause a spike in blood pressure and appears to be dose-dependent; avoid the use of epinephrine-impregnated retraction cord.
-------	--

Devices	Patients who have coronary artery stents do not require antibiotic prophylaxis.
---------	---

E

Equipment	Recommended management includes placement of IV line, continuous ECG monitoring, ongoing monitoring of vital signs, and use of a pulse oximeter.
Emergencies	Precipitation of an angina attack, MI, arrhythmia, or cardiac arrest is possible. Have nitroglycerin readily available as well as oxygen. Be prepared to perform basic life support (activate EMS, provide CPR, use AED, if needed).

AED, Automated external defibrillator; CABG, coronary artery bypass graft; CPR, cardiopulmonary resuscitation; ECG, electrocardiogram; EMS, emergency medical services; IV, intravenous; MI, myocardial infarction.

risk category, and elective dental care should be deferred and medical consultation obtained. Likewise, a patient who has a history of MI in association with other clinical risk factors (e.g., valvulopathy, heart failure, arrhythmia) is at increased risk for an adverse event, and medical consultation should be obtained before elective dental care.

Chair. The clinician should ensure a comfortable chair position and avoid rapid position changes. A rapid change in chair position can cause hypotension and a change in hemodynamics that can potentially affect the heart and blood pressure, especially in patients who take nitrates and antihypertensive medications.

Drug Considerations. Nonsteroidal antiinflammatory drugs (NSAIDs) (except for aspirin) should be avoided in patients with established hypertension and coronary

artery disease, especially those whose cardiac history includes an MI.⁵¹ In several studies, the use of NSAIDs in patients with previous MI has been shown to increase the risk for a subsequent MI, even after only 7 days of NSAID administration.^{51–53} Only naproxen did not increase the risk. Whether shorter duration of use decreases the risk is not clear, but this correlation seems likely; thus, we recommend that NSAIDs be used with caution, if at all, in patients who have had a previous MI and that if an NSAID is used, naproxen be the drug of choice, administered for less than 7 days.

The use of *vasoconstrictors* in local anesthetics poses potential problems for patients with ischemic heart disease because of the possibility of precipitating cardiac tachycardias, arrhythmias, and increases in blood pressure. Local anesthetics without vasoconstrictors may be used as

needed. If a vasoconstrictor is necessary, patients with intermediate clinical risk factors and those taking nonselective beta-blockers can safely be given up to 0.036 mg of epinephrine (two cartridges containing 1:100,000 epinephrine) at one appointment; intravascular injections are to be avoided. Greater quantities of vasoconstrictor may well be tolerated, but increasing quantities increase the risk of adverse cardiovascular effects. For patients at higher risk, the use of vasoconstrictors should be discussed with the physician. Studies have shown, however, that modest quantities of vasoconstrictors may be used safely even in high-risk patients when accompanied by oxygen, sedation, nitroglycerin, and excellent pain control measures.^{46,54,55}

For patients at all levels of cardiac risk, the use of gingival retraction cord impregnated with epinephrine should be avoided because of the rapid absorption of a high concentration of epinephrine and the potential for adverse cardiovascular effects. As an alternative, plain cord saturated with tetrahydrozoline HCl 0.05% (Visine; Pfizer, New York, NY) or oxymetazoline HCl 0.05% (Afrin; Schering-Plough, Summit, NJ) provides gingival effects equivalent to those of epinephrine without adverse cardiovascular effects.⁵⁶

Drug Interactions. Many patients who have ischemic heart disease take cholesterol-lowering medications, such as simvastatin (Lipitor). Concurrent use of macrolide antibiotics has been shown to increase the plasma level of statin drugs (i.e., HMG-CoA reductase inhibitors) and increases the risk of rhabdomyolysis (myalgia and muscle weakness).⁵⁷ Similarly, macrolide antibiotics can increase the plasma level of CCBs, resulting in severe hypotension.⁵⁸ Thus, a dentist should not prescribe erythromycin or clarithromycin to patients who take either HMG-CoA reductase inhibitors (e.g., simvastatin, atorvastatin, pravastatin) or CCBs (see [Table 4.1](#)).

Oral Manifestations

Coronary atherosclerotic heart disease does not directly induce oral lesions or oral complications. However, carotid calcifications can be detected on panoramic images in about one third of patients who have atherosclerosis^{32,59} ([Fig. 4.9](#)). Also, an association between ischemic heart



FIG 4.9 Calcification of the left carotid artery as indicated by the arrow.

disease and periodontal disease, poor oral health (e.g., chronic apical periodontitis), and tooth loss has been documented.^{60,61} Drugs used in the treatment of ischemic heart disease may produce oral changes such as dry mouth, taste aberrations, and stomatitis. CCBs can induce gingival overgrowth when plaque control is less than optimal and is more prominent at anterior interproximal sites. In rare cases, patients with angina or ACS may experience pain referred to the neck, shoulder, lower jaw, or teeth.^{28,29} The pattern of onset of pain with physical activity and its disappearance with rest usually serves as a diagnostic clue as to its cardiac origin.

REFERENCES

1. Mozaffarian D, Benjamin EJ, Go AS, et al. Heart Disease and Stroke Statistics-2016 Update: A report from the American Heart Association. *Circulation*. 2016;133(4):e38-e360.
2. Tuzcu EM, Kapadia SR, Tutar E, et al. High prevalence of coronary atherosclerosis in asymptomatic teenagers and young adults: evidence from intravascular ultrasound. *Circulation*. 2001;103(22):2705-2710.
3. Libby P. Inflammation and cardiovascular disease mechanisms. *Am J Clin Nutr*. 2006;83(2):456S-60S.
4. Virmani R, Robinowitz M, Geer JC, et al. Coronary artery atherosclerosis revisited in Korean war combat casualties. *Arch Pathol Lab Med*. 1987;111(10):972-976.
5. Lloyd-Jones D. Epidemiology of cardiovascular disease. In: Goldman L, Schafer A, eds. *Goldman-Cecil Medicine*. Philadelphia: Saunders/Elsevier; 2016:257-262.
6. Centers for Disease Control and Prevention. Heart Disease Facts. Available at: <http://www.cdc.gov/HeartDisease/facts.htm>. Accessed 26 February 2016.
7. Sesso HD, Lee IM, Gaziano JM, et al. Maternal and paternal history of myocardial infarction and risk of cardiovascular disease in men and women. *Circulation*. 2001;104(4):393-398.
8. Chow CK, Islam S, Bautista L, et al. Parental history and myocardial infarction risk across the world: the INTERHEART Study. *J Am Coll Cardiol*. 2011;57(5):619-627.
9. Murabito JM, Pencina MJ, Nam BH, et al. Sibling cardiovascular disease as a risk factor for cardiovascular disease in middle-aged adults. *JAMA*. 2005;294(24):3117-3123.
10. Chobanian AV, Bakris GL, Black HR, et al. The Seventh Report of the Joint National Committee on Prevention, Detection, Evaluation, and Treatment of High Blood Pressure: the JNC 7 report. *JAMA*. 2003;289(19):2560-2572.
11. Vasan RS, Larson MG, Leip EP, et al. Impact of high-normal blood pressure on the risk of cardiovascular disease. *N Engl J Med*. 2001;345(18):1291-1297.
12. Garrett BE, Dube SR, Troscclair A, et al. Cigarette smoking - United States, 1965-2008. *MMWR Surveill Summ*. 2011;60(suppl):109-113.
13. Jha P, Ramasundarahettige C, Landsman V, et al. 21st-century hazards of smoking and benefits of

- cessation in the United States. *N Engl J Med.* 2013;368(4):341-350.
14. Howard BV, Rodriguez BL, Bennett PH, et al. Prevention Conference VI: diabetes and cardiovascular disease: writing group I: epidemiology. *Circulation.* 2002;105(18):e132-e137.
 15. Gu K, Cowie CC, Harris MI. Mortality in adults with and without diabetes in a national cohort of the U.S. population, 1971-1993. *Diabetes Care.* 1998;21(7):1138-1145.
 16. Udell JA, Steg PG, Scirica BM, et al. Metabolic syndrome, diabetes mellitus, or both and cardiovascular risk in outpatients with or at risk for atherothrombosis. *Eur J Prev Cardiol.* 2014;21(12):1531-1540.
 17. Aguilar M, Bhuket T, Torres S, et al. Prevalence of the metabolic syndrome in the United States, 2003-2012. *JAMA.* 2015;313(19):1973-1974.
 18. Beck JD, Eke P, Heiss G, et al. Periodontal disease and coronary heart disease: a reappraisal of the exposure. *Circulation.* 2005;112(1):19-24.
 19. Lockhart PB, Bolger AF, Papapanou PN, et al. Periodontal disease and atherosclerotic vascular disease: does the evidence support an independent association?: a scientific statement from the American Heart Association. *Circulation.* 2012;125(20):2520-2544.
 20. Elter JR, Hinderliter AL, Offenbacher S, et al. The effects of periodontal therapy on vascular endothelial function: a pilot trial. *Am Heart J.* 2006;151(1):47.
 21. Slocum C, Kramer C, Genco CA. Immune dysregulation mediated by the oral microbiome: potential link to chronic inflammation and atherosclerosis. *J Intern Med.* 2016;280(1):114-128.
 22. Chen ZY, Chiang CH, Huang CC, et al. The association of tooth scaling and decreased cardiovascular disease: a nationwide population-based study. *Am J Med.* 2012;125(6):568-575.
 23. Teeuw WJ, Slot DE, Susanto H, et al. Treatment of periodontitis improves the atherosclerotic profile: a systematic review and meta-analysis. *J Clin Periodontol.* 2014;41(1):70-79.
 24. Lam OL, Zhang W, Samaranayake LP, et al. A systematic review of the effectiveness of oral health promotion activities among patients with cardiovascular disease. *Int J Cardiol.* 2011;151(3):261-267.
 25. Libby P, Theroux P. Pathophysiology of coronary artery disease. *Circulation.* 2005;111(25):3481-3488.
 26. Waters D. Acute coronary syndrome: unstable angina and non-ST segment elevation myocardial infarction. In: Goldman A, Ausiello D, eds. *Cecil Textbook of Medicine.* Philadelphia: Saunders; 2008:491-500.
 27. Ambrose JA, Martinez EE. A new paradigm for plaque stabilization. *Circulation.* 2002;105(16):2000-2004.
 28. Danesh-Sani SH, Danesh-Sani SA, Zia R, et al. Incidence of craniofacial pain of cardiac origin: results from a prospective multicentre study. *Aust Dent J.* 2012;57(3):355-358.
 29. Kreiner M, Alvarez R, Waldenstrom A, et al. Craniofacial pain of cardiac origin is associated with inferior wall ischemia. *J Oral Facial Pain Headache.* 2014;28(4):317-321.
 30. Canto JG, Goldberg RJ, Hand MM, et al. Symptom presentation of women with acute coronary syndromes: myth vs reality. *Arch Intern Med.* 2007;167(22):2405-2413.
 31. Kong MH, Fonarow GC, Peterson ED, et al. Systematic review of the incidence of sudden cardiac death in the United States. *J Am Coll Cardiol.* 2011;57(7):794-801.
 32. Friedlander AH, Cohen SN. Panoramic radiographic atheromas portend adverse vascular events. *Oral Surg Oral Med Oral Pathol Oral Radiol Endod.* 2007;103(6):830-835.
 33. Reddy K, Khaliq A, Henning RJ. Recent advances in the diagnosis and treatment of acute myocardial infarction. *World J Cardiol.* 2015;7(5):243-276.
 34. Kushner FG, Hand M, Smith SC Jr, et al. 2009 focused updates: ACC/AHA guidelines for the management of patients with ST-elevation myocardial infarction (updating the 2004 guideline and 2007 focused update) and ACC/AHA/SCAI guidelines on percutaneous coronary intervention (updating the 2005 guideline and 2007 focused update): a report of the American College of Cardiology Foundation/American Heart Association Task Force on Practice Guidelines. *Circulation.* 2009;120(22):2271-2306.
 35. Lewandrowski KB. Cardiac markers of myocardial necrosis: a history and discussion of milestones and emerging new trends. *Clin Lab Med.* 2014;34(1):31-41, xi.
 36. Husted SE, Ohman EM. Pharmacological and emerging therapies in the treatment of chronic angina. *Lancet.* 2015;386(9994):691-701.
 37. Mazzarelli J, Hollenberg S. Acute coronary syndromes. In: Vincent J-L, Abraham E, Moore F, et al, eds. *Textbook of Critical Care.* Philadelphia: Saunders/Elsevier; 2011:548-558.
 38. Teirstein P, Lytle B. Interventional and surgical treatment of coronary artery diseases. In: Goldman L, Schafer AI, eds. *Goldman-Cecil Medicine.* Philadelphia: Saunders/Elsevier; 2016:456-461.
 39. Meine TJ, Roe MT, Chen AY, et al. Association of intravenous morphine use and outcomes in acute coronary syndromes: results from the CRUSADE Quality Improvement Initiative. *Am Heart J.* 2005;149(6):1043-1049.
 40. Anderson JL, Adams CD, Antman EM, et al. 2012 ACCF/AHA focused update incorporated into the ACCF/AHA 2007 guidelines for the management of patients with unstable angina/non-ST-elevation myocardial infarction: a report of the American College of Cardiology Foundation/American Heart Association Task Force on Practice Guidelines. *J Am Coll Cardiol.* 2013;61(23):e179-e347.
 41. Fleisher LA, Beckman JA, Brown KA, et al. ACC/AHA 2007 guidelines on perioperative cardiovascular evaluation and care for noncardiac surgery: executive summary: a report of the American College of Cardiology/American Heart Association Task Force on Practice Guidelines (Writing Committee to Revise the 2002 Guidelines on Perioperative Cardiovascular Evaluation for Noncardiac Surgery): Developed in Collaboration With the American Society of Echocardiography, American Society of Nuclear Cardiology, Heart Rhythm Society, Society of Cardiovascular Anesthesiologists, Society for

- Cardiovascular Angiography and Interventions, Society for Vascular Medicine and Biology, and Society for Vascular Surgery. *Circulation*. 2007;116(17):1971-1996.
42. Fleisher LA, Fleischmann KE, Auerbach AD, et al. ACC/AHA guideline on perioperative cardiovascular evaluation and management of patients undergoing noncardiac surgery. *J Am Coll Cardiol*. 2014;64(22):e77-e137.
 43. Smith MM, Barbara DW, Mauermann WJ, et al. Morbidity and mortality associated with dental extraction before cardiac operation. *Ann Thorac Surg*. 2014;97(3):838-844.
 44. Minassian C, D'Aiuto F, Hingorani AD, et al. Invasive dental treatment and risk for vascular events: a self-controlled case series. *Ann Intern Med*. 2010;153(8):499-506.
 45. Skaar D, O'Connor H, Lunos S, et al. Dental procedures and risk of experiencing a second vascular event in a Medicare population. *J Am Dent Assoc*. 2012;143(11):1190-1198.
 46. Niwa H, Sato Y, Matsuura H. Safety of dental treatment in patients with previously diagnosed acute myocardial infarction or unstable angina pectoris. *Oral Surg Oral Med Oral Pathol Oral Radiol Endod*. 2000;89(1):35-41.
 47. Baddour LM, Bettmann MA, Bolger AF, et al. Nonvalvular cardiovascular device-related infections. *Circulation*. 2003;108(16):2015-2031.
 48. Brennan MT, Wynn RL, Miller CS. Aspirin and bleeding in dentistry: an update and recommendations. *Oral Surg Oral Med Oral Pathol Oral Radiol Endod*. 2007;104(3):316-323.
 49. Grines CL, Bonow RO, Casey DE Jr, et al. Prevention of premature discontinuation of dual antiplatelet therapy in patients with coronary artery stents: a science advisory from the American Heart Association, American College of Cardiology, Society for Cardiovascular Angiography and Interventions, American College of Surgeons, and American Dental Association, with representation from the American College of Physicians. *J Am Coll Cardiol*. 2007;49(6):734-739.
 50. Wahl MJ. Myths of dental surgery in patients receiving anticoagulant therapy. *J Am Dent Assoc*. 2000;131(1):77-81.
 51. Bavry AA, Khaliq A, Gong Y, et al. Harmful effects of NSAIDs among patients with hypertension and coronary artery disease. *Am J Med*. 2011;124(7):614-620.
 52. Schjerning Olsen AM, Fosbol EL, Lindhardsen J, et al. Duration of treatment with nonsteroidal anti-inflammatory drugs and impact on risk of death and recurrent myocardial infarction in patients with prior myocardial infarction: a nationwide cohort study. *Circulation*. 2011;123(20):2226-2235.
 53. Olsen AM, Fosbol EL, Lindhardsen J, et al. Long-term cardiovascular risk of nonsteroidal anti-inflammatory drug use according to time passed after first-time myocardial infarction: a nationwide cohort study. *Circulation*. 2012;126(16):1955-1963.
 54. Cintron G, Medina R, Reyes AA, et al. Cardiovascular effects and safety of dental anesthesia and dental interventions in patients with recent uncomplicated myocardial infarction. *Arch Intern Med*. 1986;146(11):2203-2204.
 55. Findler M, Galili D, Meidan Z, et al. Dental treatment in very high risk patients with active ischemic heart disease. *Oral Surg Oral Med Oral Pathol*. 1993;76(3):298-300.
 56. Bowles WH, Tardy SJ, Vahadi A. Evaluation of new gingival retraction agents. *J Dent Res*. 1991;70(11):1447-1449.
 57. Thompson PD, Clarkson P, Karas RH. Statin-associated myopathy. *JAMA*. 2003;289(13):1681-1690.
 58. Gandhi S, Fleet JL, Bailey DG, et al. Calcium-channel blocker-clarithromycin drug interactions and acute kidney injury. *JAMA*. 2013;310(23):2544-2553.
 59. Friedlander AH. Atheromas on panoramic radiographs often denote stenotic lesions and portend adverse vascular events. *Oral Surg Oral Med Oral Pathol Oral Radiol Endod*. 2007;104(4):451-452, author reply 52-4.
 60. Caplan DJ. Chronic apical periodontitis is more common in subjects with coronary artery disease. *J Evid Based Dent Pract*. 2014;14(3):149-150.
 61. Holmlund A, Holm G, Lind L. Number of teeth as a predictor of cardiovascular mortality in a cohort of 7,674 subjects followed for 12 years. *J Periodontol*. 2010;81(6):870-876.

Cardiac Arrhythmias

Cardiac arrhythmia refers to any variation in the normal heartbeat and includes disturbances in rhythm, rate, or the conduction pattern of the heart. Cardiac arrhythmias are present in a significant percentage of the population, many of whom will seek dental treatment. Most arrhythmias are of little clinical concern for either the patient or the dentist; however, some can produce symptoms, including anxiety and loss of consciousness, and a few may be life threatening.

Potentially fatal arrhythmias can be precipitated by strong emotion such as anxiety or anger^{1,2} and by various drugs,^{3,4} both of which are factors likely to be encountered in the dental setting. Therefore, patients with significant arrhythmias must be identified before undergoing dental treatment so appropriate modifications in dental management are administered. Dental practitioners also should be aware that patients with significant arrhythmias are at risk for fatal cardiac arrhythmias, which can be precipitated by strong emotion, various drugs, or the performance of dental procedures.

EPIDEMIOLOGY

Cardiac arrhythmias are relatively common in the general population, and their prevalence increases with age. They more frequently occur in older adults, people with a long history of smoking or alcohol use, patients with underlying ischemic heart disease, and those taking certain drugs or who have various systemic diseases.^{3,5} In the United States, arrhythmias occur in 15% to 17% of the population^{3,6-9} and are present in about 35% of people older than 65 years of age.¹⁰ In studies of patients treated in dental and other health care settings, about 4% of the detected arrhythmias have been serious, potentially life-threatening cardiac arrhythmias. Arrhythmias directly account for more than 36,000 deaths annually and constitute the underlying or contributing cause in almost 460,000 cases. The most common type of persistent arrhythmia is atrial fibrillation (AF). AF affects more than 2.7 million people, and the majority are older than 60 years of age.^{3,11,12} In a dental practice of 2000 adults, one can expect about 300 patients to have some type of cardiac arrhythmia.

ETIOLOGY

Cardiac contractions are controlled by a complex system of specialized excitatory and conductive neuronal circuitry

(Fig. 5.1). The normal pattern of sequential depolarization involves the structures of the heart in the following order: (1) sinoatrial (SA) node, (2) atrioventricular (AV) node, (3) bundle of His, (4) right and left bundle branches, and finally (5) subendocardial Purkinje network.¹³ The electrocardiogram (ECG) is a recording of this electrical activity. The primary anatomic pacemaker for the heart is the SA node, a crescent-shaped structure 9 to 15 mm long that is located at the junction of the superior vena cava and the right atrium. The SA node regulates the functions of the atria and is responsible for production of the P wave (atrial depolarization) on the ECG (Fig. 5.2). The ends of the sinus nodal fibers connect with atrial muscle fibers. The generated action potential travels along the muscle fibers (internodal pathways) and eventually arrives at and excites the AV node, which serves as a gate that regulates the entry of atrial impulses into the ventricles. It also slows the conduction rate of impulses generated within the SA node. From the AV node, impulses travel along the AV bundle (His bundle) within the ventricular septum, which divides into right and left bundle branches. The bundle branches then terminate in the small Purkinje fibers, which course throughout the ventricles and become continuous with cardiac muscle fibers. Simultaneous depolarization of the ventricles produces the QRS complex on ECG. The T wave is formed by repolarization of the ventricles. Repolarization of the atria occurs at about the same time as depolarization of the ventricles and thus is usually obscured by the QRS wave.¹³

Normal cardiac function depends on cellular automaticity (impulse formation), conductivity, excitability, and contractility. Disorders in automaticity and conductivity constitute the underlying cause of the vast majority of cardiac arrhythmias. Under normal conditions, the SA node is responsible for impulse formation, resulting in a sinus rhythm with a normal rate of 60 to 100 beats/min.¹⁴ However, other cells or groups of cells also are capable of generating impulses (ectopic pacemakers), and under certain conditions, these may emerge outside of the normal conduction system. After a normal impulse is generated (depolarization), cells of the SA node need time for recovery and repolarization and are said to be refractory; during this time, they cannot conduct an impulse. Disturbances causing complete refractoriness result in a block, and those inducing partial refractoriness result in delay of conductivity.

Disorders of conductivity (block or delay) paradoxically may lead to rapid cardiac rhythm through the mechanisms of reentry. Reentry arrhythmias occur when accessory or ectopic pacemakers reexcite previously depolarized fibers before they would become depolarized in the normal sequential impulse pathway, typically producing

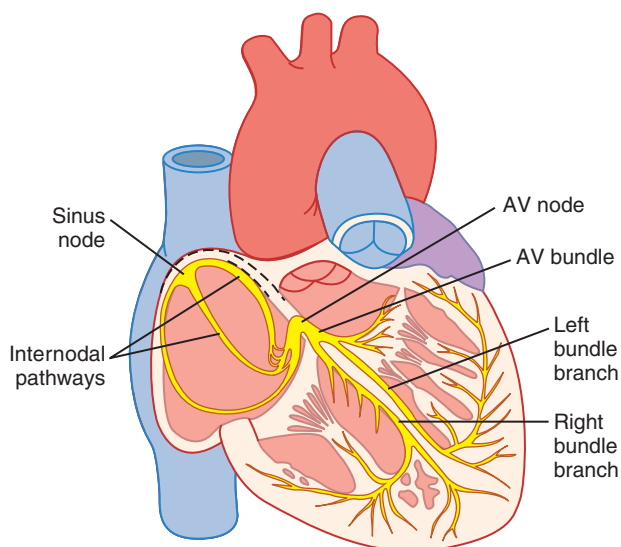

FIG 5.1 The electrical conduction system of the heart. AV, Atrioventricular. (From Hall JE: *Guyton and Hall textbook of medical physiology*, ed 12, Philadelphia, 2011, Saunders.)

tachyarrhythmias. The type of arrhythmia may suggest the nature of its cause. For example, paroxysmal atrial tachycardia with block suggests digitalis toxicity.¹⁴ However, many cardiac arrhythmias are not specific for a given cause. In such cases, a careful search is undertaken to identify the cause of the arrhythmia. The most common causes of arrhythmias include primary cardiovascular disorders, pulmonary disorders (e.g., embolism, hypoxia), autonomic disorders, systemic disorders (e.g., thyroid disease), drug-related adverse effects, and electrolyte imbalances.¹⁵ Cardiac arrhythmias also are associated with many systemic diseases (Table 5.1) and various drugs or other substances, including foods^{14,16} (Table 5.2).

PATHOPHYSIOLOGY AND COMPLICATIONS

The outcome of an arrhythmia often depends on the nature of the arrhythmia and the physical condition of the patient. For example, a young healthy person with paroxysmal atrial tachycardia may have minimal symptoms, but an older adult who has heart disease with the same arrhythmia is at risk for developing shock, congestive heart failure, or myocardial ischemia. Furthermore, evidence suggests that patients with certain types of cardiac arrhythmias (e.g., AF) are susceptible to ischemic events within the dental office.¹⁷

Arrhythmias are classified by site of origin (Box 5.1). Any arrhythmia that arises above the bifurcation of the

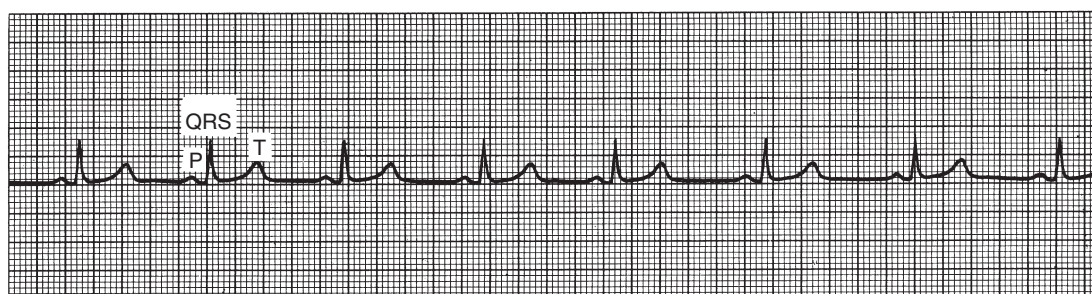

A

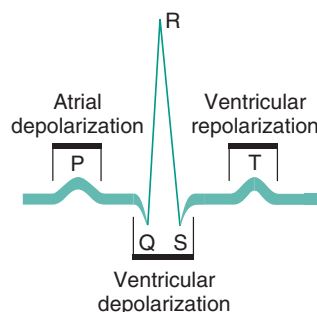

B

FIG 5.2 A, Electrocardiographic (ECG) tracing of the cardiac cycle. **B**, Normal ECG deflections. The normal ECG consists of a P wave, representing atrial depolarization; a QRS complex, representing ventricular depolarization; and a T wave, representing rapid repolarization of the ventricles. (A, From Goldberger AL, Goldberger E: *Clinical electrocardiography: a simplified approach*, ed 4, St. Louis, 1990, Mosby. B, From Pagana KD, Pagana TJ: *Mosby's manual of diagnostic and laboratory tests*, ed 4, St. Louis, 2010, Mosby.)

TABLE 5.1 Cardiac Arrhythmias Associated With Various Systemic Diseases

Arrhythmia	Associated Systemic Conditions
Sinus bradycardia	Infectious diseases, hypothermia, myxedema, obstructive jaundice, increased intracranial pressure, MI
Atrial extrasystoles	Congestive heart failure, coronary insufficiency, MI
Sinoatrial block	Rheumatic heart disease, MI, acute infection
Sinus tachycardia	Febrile illness, infection, anemia, hyperthyroidism
Atrial tachycardia	Obstructive lung disease, pneumonia, MI
Atrial flutter	Ischemic heart disease, mitral stenosis, MI, open heart surgery
Atrial fibrillation	MI, mitral stenosis, ischemic heart disease, thyrotoxicosis, hypertension
Atrioventricular block	Rheumatic heart disease, ischemic heart disease, myocardial infarction, hyperthyroidism, Hodgkin disease, myeloma, open heart surgery
Ventricular extrasystole	Ischemic heart disease, congestive heart failure, MVP
Ventricular tachycardia	MVP, MI, coronary atherosclerotic heart disease
Ventricular fibrillation	Blunt cardiac trauma, MVP, anaphylaxis, cardiac surgery, rheumatic heart disease, cardiomyopathy, coronary atherosclerotic heart disease

MI, Myocardial infarction; MVP, mitral valve prolapse.

BOX 5.1 Classification of Common Cardiac Arrhythmias

Supraventricular Arrhythmias

- Sinus nodal disturbances
 - Sinus arrhythmia
 - Sinus tachycardia
 - Sinus bradycardia
- Disturbances of atrial rhythm
 - Premature atrial complexes
 - Atrial flutter
 - Atrial fibrillation
 - Atrial tachycardias
- Tachycardias involving the AV junction
 - Preexcitation syndrome (Wolff-Parkinson-White)
- Heart block
 - Atrioventricular (AV) block or complete AV block

Ventricular Arrhythmias

- Premature ventricular complexes
- Ventricular tachycardia
- Ventricular fibrillation

Disorders of Repolarization

- Long QT syndrome

TABLE 5.2 Drugs and Foods That Can Induce Cardiac Arrhythmias

Cardiac Arrhythmia	Precipitating Drugs and Food Substances
Bradycardia	Digitalis Morphine Beta-blockers Calcium channel blockers
Tachycardia	Atropine Epinephrine Nicotine Ephedrine Caffeine
Premature atrial beats	Alcohol Nicotine Tricyclic antidepressants Caffeine
Ventricular extrasystoles	Digitalis Alcohol Epinephrine Amphetamines
Ventricular tachycardia	Digitalis Quinidine Procainamide Potassium Sympathetic amines

His bundle into right and left bundle branches is classified as supraventricular.¹⁸ Supraventricular cardiac arrhythmias may be broadly categorized into tachyarrhythmias and bradyarrhythmias. Brief descriptions of some of the more common arrhythmias likely to be encountered in dental patients are provided.

Supraventricular Arrhythmias

Sinus Nodal Disturbances

- **Sinus arrhythmia.** Sinus arrhythmia is characterized by phasic variation in sinus cycle length (i.e., length of the P-P interval).¹⁴ In the *respiratory* type of sinus arrhythmia, heart rate increases with inhalation and decreases with exhalation. It is seen predominantly in young individuals and reflects variations in parasympathetic and sympathetic signals to the heart and is considered a normal event. *Nonrespiratory* sinus arrhythmia is unrelated to respiratory effort and is seen in digitalis intoxication.
- **Sinus tachycardia.** *Tachycardia* in an adult is defined as a heart rate greater than 100 beats/min, with otherwise normal findings on the ECG.¹⁴ The rate usually is between 100 and 180 beats/min. This condition most often is a physiologic response to exercise, anxiety, stress, or emotion, which triggers increased sympathetic tone. Pathophysiologic causes include fever, hypotension, hypoxia, infection, anemia, hyperthyroidism, and heart failure. Drugs that may cause sinus tachycardia

include atropine, epinephrine, alcohol, nicotine, and caffeine.

- **Sinus bradycardia.** *Bradycardia* is defined as a heart rate less than 60 beats/min, with an otherwise normal ECG tracing.¹⁴ It often coexists with a sinus arrhythmia. It is relatively common among well-conditioned athletes and healthy young adults and decreases in prevalence with advancing age. Pathophysiologic causes of bradycardia include intracranial tumor, increased intracranial pressure, myxedema, hypothermia, and gram-negative sepsis. Bradycardia may occur during vomiting and vasovagal syncope and as the result of carotid sinus stimulation. Drugs that may cause bradycardia include lithium, amiodarone, beta-blockers, clonidine, and calcium channel blockers.

Disturbances of Atrial Rhythm

- **Atrial Premature Beats (APBs).** Impulses arising from ectopic foci anywhere in the atrium may result in APBs. APBs, also known as premature atrial complexes or contractions, occur frequently in otherwise healthy people but often occur during infection, inflammation, or myocardial ischemia.¹⁴ APBs produce a sensation of a skipped beat or palpitations and may be provoked by smoking, lack of sleep, excessive caffeine, or alcohol.¹³ They are common in persons older than 60 years of age and in conditions associated with dysfunction of the atria such as heart failure.
- **Atrial flutter.** Atrial flutter is characterized by a rapid, regular atrial rate of 250 to 350 beats/min. It is rare in healthy persons; occurs in about 0.15% of older adults; and most often occurs in association with septal defects, pulmonary emboli, obstructive lung disease, mitral or tricuspid valve stenosis or regurgitation, or chronic ventricular failure.^{12,14} Atrial flutter also may be noted in patients with hyperthyroidism, alcoholism, or pericarditis.
- **Atrial fibrillation.** AF is the most common sustained arrhythmia in adults, and its prevalence is strongly associated with age and hypertension.¹⁴ AF is characterized by rapid, disorganized, and ineffective atrial contractions that occur at a rate of 350 to 600 beats/min. The ventricular response is highly irregular. The atria do not contract effectively, thereby promoting the formation of intraarterial clots, along with consequent embolism and stroke. The development of AF is associated with systemic hypertension, valvular heart disease, left atrial enlargement, diabetes, heart failure, stroke, and heavy alcohol use, as well as with advanced age.^{19,20} It may occur intermittently or may be chronic. Symptoms are variable and depend on underlying cardiac status, ventricular rate, and loss of atrial contraction. Complications of AF include increased risk of a stroke (fourfold increase) and thromboembolism.
- **Atrial tachycardias.** Any tachycardia arising above the AV junction for which the ECG shows a P-wave

configuration different from that for sinus rhythm is called *atrial tachycardia*.¹⁹ Atrial tachycardia is characterized by an atrial rate between 150 and 200 beats/min¹⁴ and may result from enhanced normal automaticity, abnormal automaticity, triggered activity, or reentry. It commonly is seen in patients with coronary artery disease, myocardial infarction (MI), cor pulmonale (right ventricular hypertrophy and pulmonary hypertension), or digitalis intoxication.

Tachycardias Involving the Atrioventricular Junction

- **Preexcitation syndrome** (e.g., Wolff-Parkinson-White syndrome). The atria and ventricles are electrically insulated from each other by fibrous tissue that forms the anatomic AV junction. Normally, impulses are transmitted from atria to ventricles across this electrical bridge; however, in some persons, additional electrical bridges connect the atria and ventricles, bypassing the normal pathways and forming the basis for preexcitation syndromes such as Wolff-Parkinson-White syndrome. The basic defect in this disorder involves premature activation (preexcitation) of the ventricles by way of an accessory AV pathway that allows the normal SA-AV pathway to be bypassed. This accessory pathway allows rapid conduction and short refractoriness, with impulses passed rapidly between atria and ventricles, and it provides a route for reentrant (backflow) tachyarrhythmias. Resultant paroxysmal tachycardia is characterized by a normal QRS complex, a regular rhythm, and ventricular rates of 150 to 250 beats/min, along with sudden onset and termination. Wolff-Parkinson-White syndrome is found in all age groups but is more prevalent among men and decreases with age. For most patients with recurrent tachycardia, the prognosis is good, but sudden death occurs rarely, at a frequency of 0.1%.¹⁴

Heart Block

- **AV block.** Heart block is a disturbance of impulse conduction that may be permanent or transient, depending on the underlying anatomic or functional impairment. AV block occurs when the atrial impulse is conducted with delay or is not conducted at all to the ventricles at a time when the AV junction is not physiologically refractory.¹⁴ Conduction delay may occur at the AV node, within the His-Purkinje system (bundle branches), or at both sites. Conduction impairment in heart block is classified by severity, with the various forms divided into three categories (first-, second-, or third-degree [complete] block).¹⁴ During first-degree heart block, conduction time is prolonged, but all impulses are conducted. Second-degree heart block occurs in two forms: Mobitz type I (Wenckebach) and type II. Mobitz I heart block is characterized by progressive lengthening of conduction time resulting in a nonconducted P wave. Type II second-degree heart block denotes occasional or repetitive sudden block of conduction of an impulse without previous

lengthening of conduction time. When no impulses are conducted, complete or third-degree block is present. AV block may be caused by a multitude of conditions such as surgery, electrolyte disturbance, myoendocarditis, tumor, myxedema, rheumatoid nodules, Chagas disease,* calcific aortic stenosis, polymyositis, and amyloidosis. In children, the most common cause is congenital. Drugs (e.g., digitalis, propranolol, potassium, quinidine) also may cause AV heart block. Symptoms increase in severity with increasing degree of block, with first-degree and Mobitz I block being asymptomatic and Mobitz II and third-degree block requiring a permanent pacemaker.

Ventricular Arrhythmias

- **Premature ventricular complexes (PVCs).** PVCs (or contractions) are very common arrhythmias that are characterized by the premature occurrence of an abnormally shaped QRS complex (ventricular contraction) followed by a pause. PVCs may occur alone, as bigeminy (every other beat is a PVC), as trigeminy (every third beat is a PVC), or with higher periodicity. The combination of two consecutive PVCs is called a couplet; three or more in a row at a rate of 100 beats/min are referred to as ventricular tachycardia.²¹ PVCs may be provoked by a variety of medications; electrolyte imbalance; tension states; and excessive use of tobacco, caffeine, and alcohol. The prevalence of PVCs increases with age; they are associated with male gender and are associated with low serum potassium concentration and heart failure. In patients without structural heart disease, PVCs have no prognostic significance and no impact on longevity or limitation of activity. Among patients with previous MI, valvular heart disease, or heart failure, frequent PVCs are associated with an increased risk of death.²²
- **Ventricular tachycardia (VT).** The occurrence of three or more ectopic ventricular beats (PVCs) at a rate of 100 or more per minute is defined as VT. VT may be sustained or episodic. Sustained VT that persists for 30 seconds or longer may require termination because of hemodynamic instability. VT can quickly degenerate into ventricular fibrillation (VF). A variant of VT called torsades de pointes is characterized by QRS complexes of changing amplitude that appear to twist around the isoelectrical line; this rhythm occurs at rates of 200 to 250 beats/min.²³ VT almost always occurs in patients with heart disease, most commonly ischemic heart disease and cardiomyopathy.¹⁴ Certain drugs such as digitalis, sympathetic amines (epinephrine), potassium, quinidine, and procainamide may induce VT.²⁴

- **Ventricular flutter and fibrillation.** Ventricular flutter and VF are lethal arrhythmias characterized by chaotic, disorganized electrical activity that results in failure of sequential cardiac contraction and inability to maintain cardiac output.¹⁹ The distinction between flutter and fibrillation can be difficult and is of academic interest only; therefore, the two can be discussed together. If these disorders are not rapidly treated within 3 to 5 minutes, death will ensue. VF occurs most commonly as a sequela of ischemic heart disease.

Disorders of Repolarization

- **Long QT syndrome.** Long QT syndrome is a disorder of the conduction system in which the recharging of the heart during repolarization (i.e., the QT interval) is delayed. It is caused by a genetic mutation in myocardial ion channels and by certain drugs or may be the result of a stroke. The condition can lead to fast, chaotic heartbeats, which can trigger unexplained syncope, a seizure, or sudden death.^{23,25}

CLINICAL PRESENTATION

Signs and Symptoms

Arrhythmias may be symptomatic or asymptomatic; however, symptoms alone cannot be relied on to determine the seriousness of an arrhythmia. Whereas some arrhythmias such as PVCs may be highly symptomatic yet are not associated with an adverse outcome, some patients with atrial fibrillation have no symptoms at all but may be at significant risk for stroke.²⁶ The symptoms most commonly associated with cardiac arrhythmias include palpitations, lightheadedness, feeling faint, syncope, and those related to congestive heart failure (e.g., shortness of breath, orthopnea). The only clinical sign of an arrhythmia is a pulse that is too fast, too slow, or irregular (Box 5.2).

Laboratory and Diagnostic Findings

The ECG is the primary tool used in the identification and diagnosis of cardiac arrhythmias. Additional tests that may be used include exercise or stress testing, ambulatory ECG (Holter) or event recording, baroreceptor reflex sensitivity testing, body surface mapping, and upright tilt-table testing. Electrode catheter techniques allow for intracavitary recordings of the specialized conducting systems, which aid greatly in the diagnosis of arrhythmias.¹⁴

MEDICAL MANAGEMENT

Management of cardiac arrhythmias involves medications, cardioversion, pacemakers, implanted cardioverter-defibrillators (ICDs), radiofrequency catheter ablation, and surgery. Patients with asymptomatic arrhythmias usually do not require therapy; those with symptomatic

*Chagas disease, also known as American trypanosomiasis, is a tropical acute and chronic parasitic disease of the Americas caused by the flagellate protozoan *Trypanosoma cruzi* usually transmitted by an insect bite.

BOX 5.2 Signs and Symptoms of Cardiac Arrhythmias

Signs

- Slow heart rate (<60 beats/min)
- Fast heart rate (>100 beats/min)
- Irregular rhythm

Symptoms

- Palpitations, fatigue
- Dizziness, syncope, angina
- Congestive heart failure
 - Shortness of breath
 - Orthopnea
 - Peripheral edema

arrhythmias typically are treated first with medications based on symptoms, type of arrhythmia, and underlying heart condition.²⁷ Patients who do not respond to medications or who are at risk for sudden death may be treated by cardioversion, ablation, or implanted pacemaker or ICD. Surgery may be necessary for the treatment of patients with certain arrhythmias. Emergency cardioversion is indicated for any tachyarrhythmias that compromise hemodynamics or are life-threatening (e.g., cardiac arrest).

Antiarrhythmic Drugs. Generally, molecular targets for optimal action of antiarrhythmic drugs involve channels within cellular membranes (cardiac myocytes) through which ions are diffused rapidly. Antiarrhythmic drugs are therefore classified on the basis of their effect on sodium, potassium, or calcium channels and whether they block beta receptors^{26,28} (Table 5.3). Class I drugs have “local anesthetic” properties or membrane-stabilizing effects and work by primarily blocking the fast sodium channels. Class II drugs are β -adrenergic-blocking agents. Class III drugs prolong the duration of the cardiac action potential and enhance refractoriness through their effects on blocking potassium channels. Class IV drugs are slow calcium channel blockers, which are used primarily for supraventricular tachycardias. Class V drugs have variable mechanism. Although this classification scheme implies a single action for each class, the reality is that they typically have multiple sites of action across different classification categories. For example, procainamide blocks both sodium and potassium channels, and amiodarone blocks sodium, potassium, and calcium channels.²⁶

Many of the antiarrhythmic drugs have very narrow therapeutic ranges, so optimum blood levels that are not too high or too low may be difficult to achieve. Thus, undermedicated patients may be at increased risk for an adverse event during dental treatment; conversely, in those who are overmedicated, drug toxicity also is a possibility.

Oral Anticoagulant (OAC) Therapy. Patients who have AF are at increased risk for stroke and thromboembolism. To reduce this risk, the American Heart Association (AHA) recommends OAC therapy. The AHA guidelines are based

on the CHA₂DS₂-VASC score (Table 5.4).²⁹ For a score of 2 or greater, OAC is recommended. There are four OACs available for use: warfarin sodium (Coumadin; Bristol-Myers Squibb, Princeton, NJ) or one of the more recently approved direct oral anticoagulant (DOAC) drugs, such as an antithrombin drug dabigatran (Pradaxa, Boehringer Ingelheim, Ridgefield, CT), or one of the direct factor Xa inhibitors: rivaroxaban (Xarelto; Janssen Pharmaceuticals, Beerse, Belgium), apixaban (Eliquis; Bristol-Myers Squibb), or edoxaban (Savaysa; Dalichi Sankyo Co, Tokyo). Warfarin is less expensive and can be used for both valvular or nonvalvular AF, whereas DOACs have limited indications—approval by the U.S. Food and Drug Administration only for nonvalvular AF. When warfarin is used in OAC therapy, the dosage is adjusted to have the international normalized ratio (INR) between 2.0 and 3.0.^{29,30} Although the DOACs are more expensive, they have a better efficacy and safety profile (i.e., cause less major bleeding) compared with warfarin when used at recommended doses.³¹⁻³³ Dosage adjustments of DOACs are required when creatinine clearance is less than 95 mL/min and in frail older adults. Because the pharmacologic profiles of DOACs are predictable after oral use, routine coagulation testing for patients on DOACs is not required; however, use of warfarin requires routine coagulation testing to ensure the INR is within the therapeutic range.

Implanted Permanent Pacemakers. More than 2.9 million people in North America have received implanted pacemakers.³⁴ A permanent, implanted pacemaker consists of a lithium battery-powered generator implanted subcutaneously in the left infraclavicular area that produces an electrical impulse that is transmitted by a lead inserted into the heart through the subclavian vein to an electrode in contact with endocardial or myocardial tissue (Fig. 5.3). The leads may be either unipolar (stimulating only one chamber) or, more commonly, bipolar (stimulating two chambers). With a bipolar pacemaker, one lead usually is inserted into the right atrium, and the second lead is positioned within the right ventricle.³⁵

Pacemakers are capable of very specific individualized pacing programs or modes, depending on the individual's needs. A classification code is used to describe the various pacing modes of a pacemaker unit, which include the chamber that is paced, the chamber that is sensed, inhibitory or tracking function capability, rate modulation capability, and capability for antitachycardia pacing or the delivery of a shock.³⁵ Most pacemakers are of the demand variety, which can detect the patient's natural heartbeat and prevent competitive pacemaker firing; they are rate adaptive. Newer units contain pacing circuits that allow for programming, memory, and telemetry. In general, pacemakers are indicated to treat bradycardias in patients with acquired AV block, congenital AV block, chronic bifascicular and trifascicular block, AV block associated with acute MI, sinus node dysfunction, hypersensitive carotid sinus and neurocardiogenic syncope,

TABLE 5.3 Drugs Used to Treat Arrhythmias

Drug	Oral Adverse Effects	Dental Considerations
CLASS I: FAST SODIUM CHANNEL BLOCKERS		
IA—Quinidine	Bitter taste, dry mouth, petechiae, gingival bleeding	Syncope, hypotension, nausea, vomiting, thrombocytopenia
IA—Procainamide	Bitter taste, oral ulcerations, xerostomia	Worsening of arrhythmias, lupus-like syndrome, rash, myalgia, fever, agranulocytosis
IA—Disopyramide (Norpace)	Dry mouth	Urinary hesitancy, constipation
IB—Mexiletine (Mexitol)	Dry mouth	Tremor, dizziness, diplopia, nausea, vomiting
IB—Lidocaine		Hypotension, seizure
IC—Propafenone (Rythmol)	Taste aberration, dry mouth	Worsening of arrhythmias, dizziness, nausea, vomiting
IC—Flecainide (Tambocor)	Metallic taste	Worsening of arrhythmias, confusion, irritability
CLASS II: BETA-BLOCKERS (PARTIAL LIST)		
Propranolol (Inderal)— nonselective beta-blocker	Taste changes; lichenoid reactions	Hypotension, bradycardia, fatigue; avoid long-term use of NSAIDs. Vasoconstrictor interactions: nonselective—potential increase in blood pressure (use maximum of 0.036 mg of epinephrine); avoid levonordefrin
Also: acebutolol, esmolol, metoprolol, atenolol, timolol		Vasoconstrictor interactions: none
CLASS III: POTASSIUM CHANNEL BLOCKERS		
Amiodarone (Cordarone)	Taste aberration (bitter taste)	May cause bradycardia when lidocaine is given as a local anesthetic. Regular blood test to rule out organ toxicity, which can appear as interstitial pneumonitis, hyper- or hypothyroidism, elevated liver enzymes, bluish skin discoloration
Sotalol (Betapace)— nonselective beta-blocker	Taste changes; lichenoid reactions	Hypotension, bradycardia, torsades de pointes, fatigue; avoid long-term use of NSAIDs. Vasoconstrictor interactions: nonselective—potential increase in blood pressure (use maximum of 0.036 mg of epinephrine); avoid levonordefrin
Dofetilide	Angioedema	Headache, dizziness
Ibutilide		Headache, bradycardia, hypotension
CLASS IV: SLOW CALCIUM CHANNEL BLOCKERS		
Verapamil (Calan)	Gingival overgrowth	Hypotension, bradycardia
Diltiazem	Gingival overgrowth	Hypotension, bradycardia, headache
CLASS V: VARIABLE MECHANISM		
Adenosine	Metallic taste, burning sensation	Hypotension, hyperventilation, bradycardia
Digoxin (Lanoxin)	Hypersalivation (toxicity)	Precipitation of arrhythmias, toxicity (headache, nausea, vomiting, altered color perception, malaise) Vasoconstrictor interactions: increased risk for arrhythmias; avoid if possible

NSAID, Nonsteroidal antiinflammatory drug.

and certain forms of cardiomyopathy. They also are indicated for the prevention and termination of certain tachyarrhythmias.³⁶

Complications are infrequent but have been reported as a result of pacemaker placement. These include pneumothorax, perforation of the atrium or ventricle, subsequent dislodgment of the leads, infection, and erosion of the pacemaker pocket.³⁵ Infective endocarditis rarely may occur; however, antibiotic prophylaxis for dental treatment is not recommended.³⁷⁻³⁹

Implantable Cardioverter-Defibrillators

An ICD is a device that is similar to a pacemaker and is implanted in the same way as for a pacemaker. ICDs are capable not only of delivering a shock but also of providing antitachycardia pacing (ATP) and ventricular bradycardia pacing. Most ICDs have a single lead that is inserted into the right ventricle and function by continuously monitoring a patient's cardiac rate and delivering ATP or a shock when the rate exceeds a predetermined cutoff point, such

TABLE 5.4 CHA₂ DS₂-VASc Scores

Letter	Points	Description
C	1	Congestive heart failure: moderate to severe systolic left ventricular dysfunction, LVEF ≤40%, or recent decompensated heart failure requiring hospitalization
H	1	History of hypertension
A	2	Age ≥75 years
D	1	Diabetes mellitus
S	2	History of stroke, transient ischemic attack, or thromboembolism
V	1	Vascular disease: history of myocardial infarction, complex aortic plaque, or peripheral artery disease
A	1	Age 65–74 years
Sc	1	Female (sex category)

LVEF, Left ventricular ejection fraction.

Dual-chamber pacemaker device

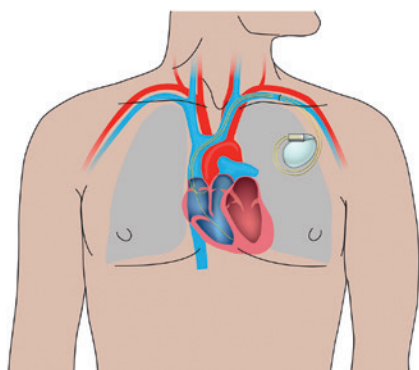

A

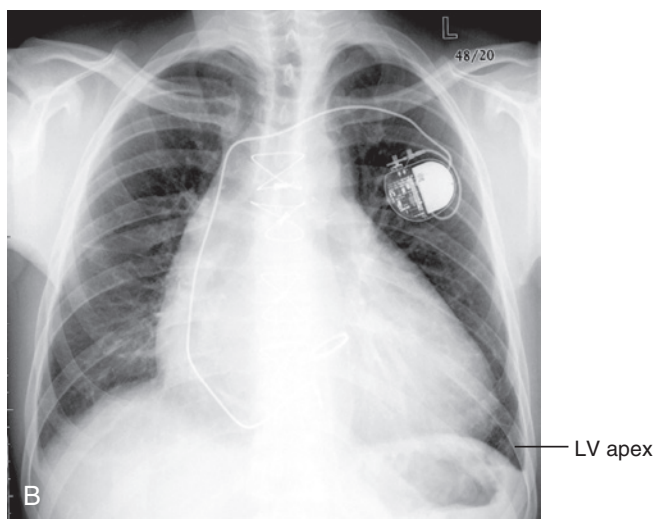

FIG 5.3 A, The site of implantation of a permanent pacemaker (note: can be inserted in the left or right intraclavicular chest wall). **B**, A chest radiograph showing a pacemaker in a patient. LV, Left ventricular. (A, Courtesy of Matt Hazzard, University of Kentucky. B, From Bonow RO, et al, editors: *Braunwald's heart disease: a textbook of cardiovascular medicine*, ed 9, Philadelphia, 2012, Saunders.)

as in VT or VF.³⁵ ATP has the advantage of terminating a rhythm disturbance without delivering a shock. ICDs generally are larger than pacemakers, and their batteries do not last as long as those of a pacemaker, the life span of ICDs being 5 to 10 years. Antibiotic prophylaxis for dental treatment in patients with these devices is not recommended.³⁹

Electromagnetic Interference. Electromagnetic interference (EMI) from nonintrinsic electrical activity can temporarily interfere with the function of a pacemaker or ICD. The pacemaker or ICD senses these extraneous signals and misinterprets them, which may cause rate alterations, sensing abnormalities, asynchronous pacing, noise reversion, or reprogramming.⁴⁰ Numerous sources of EMI are present in daily life, industry, and medical and dental settings (Box 5.3). Examples of EMI sources in daily life are cell phones, portable headphones, metal detectors, high-voltage power lines, and some home appliances (e.g., electric razor). EMI sources in the workplace include welding equipment and induction furnaces. In the medical setting, magnetic resonance imaging scanners, electrosurgery, neurostimulators, defibrillators, TENS (transcutaneous electrical nerve stimulation) units, and instrumentation from radiofrequency catheter ablation, therapeutic diathermy, therapeutic ionizing radiotherapy, ultrasonic lithotripsy, and left ventricular assist devices all are documented sources of potentially harmful EMI.^{40,41} The effects of EMI on pacemakers and ICDs vary with the shielding placed by different manufacturers, intensity of the electromagnetic field, frequency of the spectrum of the signal, distance and positioning of the device relative to the source, electrode configuration, nonprogrammable device characteristics, programmed settings, and patient characteristics. Electrical and magnetic fields are reduced inversely with the square of the distance from the source. Also of note, current models contain improved shielding and algorithms (i.e., noise reversion mode) that reduce EMI better than models made a decade ago.

Before 2000, studies performed in vitro suggested that some dental devices may cause EMI with pacemakers and ICDs.⁴² However, more recent studies performed in humans together with previous data suggest that most dental devices (i.e., ultrasonic bath cleaners; ultrasonic scaling devices; and battery-operated curing lights, amalgamators, electrical pulp testers and apex locators, handpieces, electric toothbrushes, microwave ovens, and x-ray units) do not cause significant interference with the sensing and pacing of pacemakers and ICDs.⁴²⁻⁴⁸ This probably reflects the increased internal shielding provided in the newer pacemakers and ICDs. However, caution in the use of electrosurgery units is still recommended because these units showed EMI in medical settings and in vitro, and in vivo studies with dental electrosurgery devices have yet to be performed.⁴⁰

Radiofrequency Catheter Ablation. Radiofrequency catheter ablation is a technique whereby a catheter

BOX 5.3 Sources of Potential Electromagnetic Interference for Pacemakers and Implanted Cardioverter-Defibrillators

Daily Living

- Cell phones, portable headphones, metal detectors
- High-voltage power lines
- Household appliances (e.g., electric razors)

Industrial

- Arc welders, induction furnaces

Medical

- Magnetic resonance imaging scanners
- Electrosurgery, therapeutic diathermy
- Neurostimulators, defibrillators
- Transcutaneous electrical nerve stimulation (TENS) units
- Radiofrequency catheter ablation
- Therapeutic ionizing radiotherapy
- Lithotripsy

Dental

- Electrosurgery

(electrode) is introduced percutaneously into a vein and is threaded into the heart. The catheter is positioned in contact with the area determined by electrophysiologic testing to be the anatomic source of an arrhythmia. Radiofrequency energy is then delivered through the electrode catheter whose tip is in contact with the target cardiac tissue. This results in resistive heating of the tissue, producing irreversible tissue destruction of an area 5 to 6 mm in diameter and 2 to 3 mm deep, destroying the ectopic pacemaker. This technique can eliminate a variety of supraventricular and ventricular tachycardias that previously required long-term pharmacologic treatment for suppression or surgery for cure.³⁵

Surgery

Surgery is another therapeutic approach that is used to treat patients with tachycardia. Direct surgical approaches designed to interrupt accessory pathways consist of resection of tissue and ablation.⁴⁹ In addition to direct surgical approaches, indirect approaches such as aneurysmectomy, coronary artery bypass grafting, or relief of valvular regurgitation or stenosis may be useful in selected patients.

Cardioversion and Defibrillation

Transthoracic delivery of an electric shock can be performed electively (cardioversion) to terminate persistent or refractory arrhythmias or on an emergency basis (defibrillation) to terminate a lethal arrhythmia. Direct current defibrillators deliver an electrical charge by way of two paddles (electrodes) placed on the chest wall. One electrode is placed on the left chest over the region of the apex, and the other is placed on the right side of the

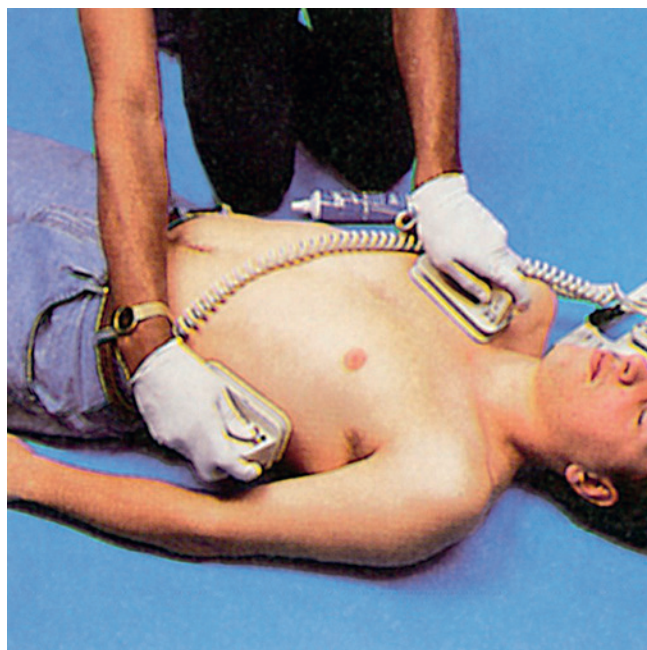

FIG 5.4 Cardioversion/defibrillation paddles in place on a patient. (From Sanders MJ: *Mosby's paramedic textbook*, ed 3, St. Louis, 2005, Mosby.)

chest just to the right of the sternum and below the clavicle (Fig. 5.4). The shock terminates arrhythmias caused by reentry by simultaneously depolarizing large portions of the atria and ventricles, thereby causing reentry circuits to disappear momentarily.³¹ Defibrillation usually is instantaneous, and cardiac pumping resumes within a few seconds. It may have to be repeated if defibrillation is unsuccessful (i.e., if a regular heartbeat is not occurring). The most common arrhythmias treated by cardioversion/defibrillation are VF, VT, AF, and atrial flutter. Treatment of patients with VF is always emergent. Treatment of patients with VT may be elective or emergent, depending on the patient's hemodynamic status. Treatment of those with atrial flutter and AF usually is elective.

Several types of automated external defibrillators (AEDs) are available for use in dental offices for emergency defibrillation. An AED should be considered for inclusion in the dentist's emergency medical kit. The use of AEDs is now taught as part of basic and advanced cardiopulmonary resuscitation courses, and familiarity with these devices and their application among laypersons is encouraged by public health agencies. These devices, now commonly found in public areas, are simple and easy to use, and emergency defibrillation is a critical part of successful resuscitation for a victim of cardiac arrest.

DENTAL MANAGEMENT

Medical Considerations

Identification. Identification of patients with a history of an arrhythmia, those with an undiagnosed arrhythmia,

and those prone to developing a cardiac rhythm disturbance is the first step in risk assessment and in avoiding an untoward event (Box 5.4). This process is accomplished by obtaining a thorough medical history, including a pertinent review of systems, and taking and evaluating vital signs (pulse rate and rhythm, blood pressure, respiratory rate). In the review of systems, patients should be asked about the presence of signs or symptoms related to the cardiovascular and pulmonary systems. Patients who report palpitations, dizziness, chest pain, shortness of breath, or syncope may have a cardiac arrhythmia or other cardiovascular disease and should be evaluated by a physician. Patients with an irregular cardiac rhythm (even without symptoms) also may require consultation with the physician to determine its significance. Patients with an existing arrhythmia, diagnosed or undiagnosed, are at increased risk for adverse events in the dental environment. In addition, patients at risk for developing an arrhythmia may be in danger in the dental office if they are not identified and measures are not taken to minimize situations that can precipitate an arrhythmia. Other patients may have their arrhythmias under control with the use of drugs or a pacemaker but require special consideration when receiving dental treatment. The keys to successful dental management of patients prone to developing a cardiac arrhythmia and those with an existing arrhythmia are identification and prevention. Even under the best of circumstances, however, a patient may develop a cardiac arrhythmia that requires immediate emergency measures.

Risk Assessment. Patients with a known history of arrhythmia should be interviewed carefully to ascertain the type of arrhythmia (if known), how it is being treated,

medications being taken, presence of a pacemaker or defibrillator, effects on their activity, and stability of their disease. Because the classification and diagnosis of arrhythmia can be complex, patients often do not know the specific diagnosis that has been assigned to their disorder; thus, the physician must be relied on to provide this information. It is important to identify any known triggers, such as stress, anxiety, or medications. The presence of other heart, thyroid, kidney, or chronic pulmonary disease also should be determined because such disorders may be a cause of or contributor to the arrhythmia and may necessitate additional changes in dental management. If any questions or uncertainties arise, a medical consultation should be sought regarding the patient's diagnosis and current status and to aid the dentist in assessing risk for aggravating or precipitating a cardiac arrhythmia, stroke, or MI during or in relation to dental treatment.

Risk assessment requires determining the type and severity of arrhythmia, stability of the patient, and potential risk involved in providing dental treatment to a patient with a history of arrhythmia. This often requires consultation with the patient's physician. The American College of Cardiology (ACC) and the AHA have published guidelines that can help make this determination.^{50,51} These guidelines are intended for use by physicians who are evaluating patients with cardiovascular disease to determine whether they can safely undergo surgical procedures. They also may be applied to the provision of dental care and may be of significant value to the dentist in making a determination of risk.

Box 5.5 is based on these ACC/AHA guidelines and provides an estimate of the risk that a serious event (acute MI, unstable angina, or sudden death) may occur during noncardiac surgery in patients with various arrhythmias. Patients with a significant arrhythmia (i.e., high-grade AV block, symptomatic ventricular arrhythmias in the presence of cardiovascular disease, and supraventricular arrhythmias with an uncontrolled ventricular rate) **are at major risk for complications and are not candidates for elective dental care.** Dental care should be deferred until a consultation with the physician has occurred. The presence of other types of arrhythmias carries significantly less risk. The presence of pathologic Q waves (marker of a previous MI) is a clinical predictor of intermediate risk for perioperative complications; other ECG abnormalities, including left ventricular hypertrophy, left bundle branch block, and ST-T wave abnormalities, as well as any rhythm other than sinus rhythm, are associated with minor perioperative risk. Patients with these types of arrhythmias can undergo elective dental treatment with only minimally increased risk for an adverse event.

The type and magnitude of the planned dental procedure also must be considered in determination of perioperative risk. Box 5.6 provides an estimate of cardiac risk for specific surgical procedures in patients with cardiovascular disease. Although dental procedures are not specifically

BOX 5.4 Identifying Patients With Cardiac Arrhythmias

Patients with cardiac arrhythmias may be identified by:

- Assessing the medical history*
 - Type of arrhythmia
 - Frequency of occurrence and severity
 - How treated
 - Presence of pacemaker or defibrillator
 - Level of control or stability
- Understanding risk for arrhythmia is increased in the presence of other cardiovascular or pulmonary disease
- Identifying the patient who does not report an arrhythmia but may be taking one or more of the antiarrhythmic drugs
- Pertinent review of systems—asking about the presence of symptoms that could be caused by arrhythmias (palpitations, dizziness, chest pain, shortness of breath, syncope)
- Obtaining vital signs suggestive of arrhythmia (rapid pulse rate, slow pulse rate, irregular pulse)
- Referring patient to physician if signs or symptoms are present that are suggestive of a cardiac arrhythmia or other cardiovascular disease

*Consultation with the patient's physician may be required to obtain or verify this information.

BOX 5.5 Perioperative Risk and Dental Treatment for Patients With Cardiac Arrhythmias

Arrhythmias Associated With Major Perioperative Risk

- High-grade AV block
- Symptomatic ventricular arrhythmias in the presence of underlying heart disease
- Supraventricular arrhythmias with uncontrolled ventricular rate
Dental management: Avoid elective dental care.

Arrhythmias Associated With Intermediate Perioperative Risk

- Abnormal Q waves on ECG (marker of previous myocardial infarction)
Dental management: Elective dental care is appropriate.

Arrhythmias Associated With Minor Perioperative Risk

- ECG abnormalities consistent with:
 - Left ventricular hypertrophy
 - Left bundle branch block
 - ST-T wave abnormalities
- Any rhythm other than sinus (e.g., atrial fibrillation)
Dental management: Elective dental care is appropriate.

AV, Atrioventricular; ECG, electrocardiogram.

Data from Fleisher LA, Beckman JA, Brown KA, et al: ACC/AHA 2007 guidelines on perioperative cardiovascular evaluation and care for noncardiac surgery: a report of the American College of Cardiology/American Heart Association Task Force on Practice Guidelines (Writing Committee to Revise the 2002 Guidelines on Perioperative Cardiovascular Evaluation for Noncardiac Surgery), *Circulation* 116:e418-e499, 2007.

listed, they would certainly be included in the low-risk category, associated with less than a 1% chance of an adverse perioperative event. Nonsurgical dental procedures are likely to pose even less risk than that for surgical procedures. More extensive oral and maxillofacial surgical procedures, and perhaps some of the more extensive periodontal surgical procedures, probably would be included in the intermediate cardiac risk category under “head and neck procedures,” with a risk of less than 5%. Procedures associated with the highest risk (>5%) include emergency major surgery in elderly persons, aortic or vascular surgery, and peripheral vascular surgery. These procedures are performed with the patient under general anesthesia and carry the potential for significant blood and fluid loss with resultant adverse hemodynamic effects. Therefore, it seems clear that the vast majority of dental procedures, whether surgical or nonsurgical, are associated with low to very low risk for an adverse event in patients with arrhythmias and other cardiovascular diseases.

Recommendations

Antibiotics: Infection Risk. Patients who have cardiac arrhythmias, pacemakers, or ICDs are not at risk for infective endocarditis related to dental procedures; thus, antibiotic prophylaxis is not indicated (Box 5.7).^{37,38,50}

BOX 5.6 Cardiac Risk Stratification for Noncardiac Surgical Procedures

High (Reported Cardiac Risk Often >5%)

- Emergent major operations, particularly in older adults
- Aortic and other major vascular surgery
- Peripheral vascular surgery
- Anticipated prolonged surgical procedures associated with large fluid shifts and/or blood loss

Intermediate (Reported Cardiac Risk Generally <5%)

- Carotid endarterectomy
- Head and neck surgery
- Intraperitoneal and intrathoracic surgery
- Orthopedic surgery
- Prostate surgery

Low (Reported Cardiac Risk Generally <1%)

- Endoscopic procedures
- Superficial procedures
- Cataract surgery
- Breast surgery

*Combined incidence of cardiac death and nonfatal myocardial infarction.

Data from Fleisher LA, Beckman JA, Brown KA, et al: ACC/AHA 2007 guidelines on perioperative cardiovascular evaluation and care for noncardiac surgery: a report of the American College of Cardiology/American Heart Association Task Force on Practice Guidelines (Writing Committee to Revise the 2002 Guidelines on Perioperative Cardiovascular Evaluation for Noncardiac Surgery), *Circulation* 116:e418-e499, 2007.

Appointment Scheduling. A patient who is susceptible to cardiac arrhythmias can receive virtually any indicated dental procedure after the arrhythmia has been identified and the appropriate recommendations mentioned here are followed. Complex dental procedures and multiple extractions should be scheduled over several appointments to avoid oversteering the patient and to limit the amount of drugs required for pain control (see Box 5.7).

Bleeding: Warfarin (Coumadin). Patients with AF often are taking warfarin to prevent thrombus formation, embolism, and stroke; thus, they are at risk for increased bleeding. The target range for anticoagulation in patients with atrial fibrillation usually is an INR between 2 and 3 times the normal value.⁵² Studies have shown that minor oral surgery, such as simple extractions, can be performed without altering or stopping the warfarin regimen, provided that the INR is between 2.0 and 3.5.⁵³⁻⁵⁶ Management recommendations include the use of local measures such as placing of gelatin sponges, oxidized cellulose, or chitosan hemostatic products in extraction sockets, suturing, gauze sponges for pressure pack, or stents during the surgery and the topical use of tranexamic acid or ε-aminocaproic acid as a mouth rinse or to soak sponges postoperatively (see Box 5.7). For more significant surgery, consultation with the physician should be obtained.

Dabigatran (Pradaxa), Rivaroxaban (Xarelto), Apixaban (Eliquis), or Edoxaban (Savaysa). Patients who have AF

BOX 5.7 Dental Management Considerations in Patients With Cardiac Arrhythmias**A****Awareness**

Potentially fatal arrhythmias can be precipitated by strong emotion, various drugs, or the performance of dental procedures in these patients.

P**Patient Evaluation and Risk Assessment (See Box 1.1)**

- Evaluate and determine whether an arrhythmia exists.
- Obtain medical consultation if the patient's heart condition is poorly controlled or if the condition is undiagnosed or if the cause or nature of the arrhythmia is uncertain.

Potential Issues and Factors of Concerns

A		C	
Analgesics	Provide good postoperative analgesia to minimize pain and associated stress.	Blood pressure	In patients taking warfarin, DOAC, or another anticoagulant or antiplatelet: <ul style="list-style-type: none"> • Use local hemostatic measures and products, including gelatin sponge, oxidized cellulose, or chitosan products in sockets, suturing, gauze pressure packs, and preoperative stents. Tranexamic acid or ϵ-aminocaproic acid can be used as mouth rinse or to soak gauze for placement at the bleeding site. Obtain pretreatment vital signs and monitor pulse and blood pressure throughout stressful and invasive procedures.
Antibiotics	For patients with pacemakers or ICDs, antibiotic prophylaxis to prevent infective endocarditis is not recommended. Some antibiotics (e.g., metronidazole, extended-spectrum penicillins) are known to increase the INR in patients on warfarin (Coumadin); caution in their use is advised.	Chair position	Ensure comfortable chair position. Raise the chair slowly, and in case of slow heart rate or hypotension, stabilize the patient in an upright position before dismissing.
Anesthesia	Ensure profound local anesthesia. Epinephrine-containing local anesthetic can be used with minimal risk if the dose is limited to 0.036 mg epinephrine (two capsules containing 1:100,000 concentration). Higher doses may be tolerated, but the risk of complications increases with dose. Avoid the use of epinephrine in retraction cord.	Devices	Pacemakers and ICDs may experience electromagnetic interference with dental equipment such as electrosurgery devices; thus, avoid electrosurgery.
Anxiety	Establish good rapport and schedule short morning appointments. Use anxiety reduction techniques to reduce catecholamine levels: <ul style="list-style-type: none"> • Provide preoperative sedation (short-acting benzodiazepine the night before and/or 1 hour before the appointment). • Administer intraoperative sedation (nitrous oxide–oxygen). 	Drugs	In patients taking digoxin, watch for signs or symptoms of toxicity (e.g., hypersalivation, visual changes) and avoid epinephrine and levonordefrin.
B		E	
Bleeding	In patients taking warfarin: <ul style="list-style-type: none"> • Review current INR laboratory test results (lab laboratory should be performed within 24 to 72 hours of the surgical procedure); confirm that the patient is taking warfarin regularly and has consistent INR within therapeutic range. • If INR is within the therapeutic range (2.0–3.5), dental treatment, including minor oral surgery, can be performed without stopping or altering the warfarin regimen. In patients taking DOAC when major oral surgery is planned: <ul style="list-style-type: none"> • Consult with physician regarding planned dental procedure and patient's coagulation status. • Ensure that the patient has normal renal function. 	Emergencies and urgent care	Have an emergency medical kit readily available. For a high-risk patient who requires urgent care, consider treating in a special care clinic or hospital where a defibrillator can be used if needed. After consulting with physician, provide limited care only for pain control, treatment of acute infection, or control of bleeding, as appropriate. The following measures may be used as needed: <ul style="list-style-type: none"> • Placement of intravenous line • Sedation • ECG monitoring • Pulse oximetry • Blood pressure monitoring • Avoiding or limiting epinephrine
		F	
		Follow-up	Patients who have had invasive procedures should be contacted between 24 and 72 hours to ensure that the postoperative course proceeds without complications.

may be taking one of the DOACs to prevent clot formation, embolism, and stroke. These agents have a better efficacy and safety profile (i.e., cause less major bleeding) than warfarin when used at recommended doses.^{31,32} Thus, DOACs are not predicted to cause concern for major bleeding during and after invasive dental procedures. However, few studies to date have evaluated these drugs in a dental setting; only dabigatran has a reversal agent (idarucizumab, Praxbind, Boehringer Ingelheim), and patients who receive higher doses as in older adults and those who have kidney function impairment are at increased risk for major bleeding.⁵⁷ Accordingly, dentists are advised to limit the number of extractions performed at one appointment, monitor kidney function, and use good local hemostatic procedures for patients taking these drugs. If extractions of four or more teeth or surgical extractions are planned, withholding the DOAC the night before surgery and resuming the drug the day after surgery has been performed with minimal complications.⁵⁸⁻⁶⁰

Capacity to Tolerate Care. Stress associated with dental treatment or use of excessive amounts of injected epinephrine may lead to life-threatening cardiac arrhythmias in susceptible dental patients. Also, patients with significant arrhythmias and those with cardiac comorbidities may have difficulty adapting to stressful dental situations.^{61,62} Thus, the dentist must provide stress reduction strategies based on the level of medical risk, type of planned dental procedure, and stability and anxiety level of the patient. Stress reduction strategies for patients with arrhythmias of low to intermediate risk may include the following: establishing good rapport, scheduling short appointments in the morning, ensuring comfortable chair position, pretreatment assessment of vital signs, preoperative oral sedation, intraoperative use of nitrous oxide–oxygen sedation, ensuring excellent local anesthesia, and providing effective postoperative pain control (see Chapter 1). On occasion, it may be necessary to provide urgent dental care to a patient with a significant arrhythmia. If treatment becomes necessary, it should be performed as conservatively as possible and should be directed primarily toward pain relief, infection control, or control of bleeding. Consultation with the patient's physician is advised. Additional management recommendations may include establishing and maintaining an intravenous line, continuously monitoring the ECG and vital signs, and using a pulse oximeter. These measures may require that the patient be treated in a special patient care facility or hospital dental clinic (see Box 5.7).

Drug Considerations

Use of Vasoconstrictors. The use of vasoconstrictors in local anesthetics poses potential problems for patients with arrhythmias because of the possibility of precipitating cardiac tachycardia or another arrhythmia. A local anesthetic without vasoconstrictor may be used as needed. If a vasoconstrictor is deemed necessary, patients in

the low- to intermediate-risk category and those taking nonselective beta-blockers can safely be given up to 0.036 mg of epinephrine (two cartridges containing 1:100,000 epinephrine); intravascular injections should be avoided.⁶³ Greater quantities of vasoconstrictor may well be tolerated, but increasing quantities are associated with increased risk for adverse cardiovascular effects. Vasoconstrictors should be avoided in patients taking digoxin because of the potential for inducing arrhythmias.^{64,65} For patients at major risk for arrhythmias, the use of vasoconstrictors should be avoided, but if their use is considered essential, it should be discussed with the physician (see Box 5.7). Studies have shown that modest amounts of vasoconstrictor can be used safely in high-risk cardiac patients when accompanied by oxygen, sedation, nitroglycerin, and excellent pain control measures.⁶⁶⁻⁶⁸

For patients at all levels of cardiac risk, the use of gingival retraction cord impregnated with epinephrine should be avoided because of the associated rapid absorption of a high concentration of epinephrine and the potential for adverse cardiovascular effects. As an alternative, plain cord saturated with tetrahydrozoline HCl 0.05% (Visine; Pfizer, New York, NY) or with oxymetazoline HCl 0.05% (Afrin; Schering-Plough, Summit, NJ) provides gingival effects equivalent to those of epinephrine without the adverse cardiovascular effects.⁶⁹

Digoxin Toxicity. Because the therapeutic range for digoxin is very narrow, toxicity can easily occur (see Box 5.7). This is a special concern in older adults and in those who have hypothyroidism, renal insufficiency, dehydration, hypokalemia, hypomagnesemia, or hypocalcemia. Patients with electrolyte disturbances generally are more susceptible to digoxin toxicity. Signs of toxicity include hypersalivation, nausea, vomiting, headache, drowsiness, visual distortions, with objects appearing yellow or green, and ventricular premature beats.⁷⁰ The dentist should be alert to these changes and refer the patient reporting such changes to the physician.

Drug Interactions. There are drug interactions to consider in addition to avoiding the epinephrine–digoxin drug–drug interaction. Macrolide antibiotics can cause cardiac arrhythmias and should be avoided in patients who have QT prolongation or bradycardia or who concurrently use class IA and class III antiarrhythmia drugs.^{71,72}

Devices: Pacemakers and Implanted Cardioverter-Defibrillators ICDs and Electromagnetic Interference

The risk of encountering significant EMI with a pacemaker in the dental office is low. Box 5.3 lists potential sources of EMI. In the dental setting, electrosurgery should not be used on or around a patient with a pacemaker or ICD until further studies are performed. Other dental devices are unlikely to cause a problem (see Box 5.7).

Oral Manifestations

The only significant oral complications found in patients with arrhythmias are those that occur as a result of adverse effects of medications used to control arrhythmia. [Table 5.3](#) lists the oral manifestations potentially associated with use of antiarrhythmic drugs.

REFERENCES

- Lampert R, Joska T, Burg MM, et al. Emotional and physical precipitants of ventricular arrhythmia. *Circulation*. 2002;106(14):1800-1805.
- Culic V, Eterovic D, Miric D, et al. Triggering of ventricular tachycardia by meteorologic and emotional stress: protective effect of beta-blockers and anxiolytics in men and elderly. *Am J Epidemiol*. 2004;160(11):1047-1058.
- Mozaffarian D, Benjamin EJ, Go AS, et al. Executive summary: heart disease and stroke statistics-2016 update: a report from the American Heart Association. *Circulation*. 2016;133(4):447-454.
- Frommeyer G, Eckardt L. Drug-induced proarrhythmia: risk factors and electrophysiological mechanisms. *Nat Rev Cardiol*. 2016;13(1):36-47.
- Guize L, Piot O, Lavergne T, et al. (Cardiac arrhythmias in the elderly]. *Bull Acad Natl Med*. 2006;190(4-5):827-841, discussion 73-6.
- Little JW, Simmons MS, Kunik RL, et al. Evaluation of an EKG system for the dental office. *Gen Dent*. 1990;38(4):278-281.
- Little JW, Simmons MS, Rhodus NL, et al. Dental patient reaction to electrocardiogram screening. *Oral Surg Oral Med Oral Pathol*. 1990;70(4):433-439.
- Simmons MS, Little JW, Rhodus NL, et al. Screening dentists for risk factors associated with cardiovascular disease. *Gen Dent*. 1994;42(5):440-445.
- Rhodus N, Little J. The prevalence of cardiac arrhythmias in dental and dental hygiene students. *Calif Inst Cont Educ Dent*. 1998;5:23-26.
- Prineas RJ, Le A, Soliman EZ, et al. United States national prevalence of electrocardiographic abnormalities in black and white middle-age (45- to 64-year) and older (≥ 65 -year) adults (from the Reasons for Geographic and Racial Differences in Stroke Study). *Am J Cardiol*. 2012;109(8):1223-1228.
- Guize L, Thomas F, Bean K, et al. [Atrial fibrillation: prevalence, risk factors and mortality in a large French population with 15 years of follow-up]. *Bull Acad Natl Med*. 2007;191(4-5):791-803, discussion 03-5.
- Chow GV, Marine JE, Fleg JL. Epidemiology of arrhythmias and conduction disorders in older adults. *Clin Geriatr Med*. 2012;28(4):539-553.
- Guyton AC, Hall JE. *Textbook of Medical Physiology*. 12 ed. Philadelphia: Saunders/Elsevier; 2011.
- Miller J, Zipes D. Diagnosis of cardiac arrhythmias. In: Mann D, Zipes D, Libby M, et al, eds. *Braunwald's Heart Disease: A Textbook of Cardiovascular Medicine*. Philadelphia: Saunders/Elsevier; 2015.
- Novo S, Barbagallo M, Abrignani MG, et al. Increased prevalence of cardiac arrhythmias and transient episodes of myocardial ischemia in hypertensives with left ventricular hypertrophy but without clinical history of coronary heart disease. *Am J Hypertens*. 1997;10(8):843-851.
- Barnes BJ, Hollands JM. Drug-induced arrhythmias. *Crit Care Med*. 2010;38(6 suppl):S188-S197.
- Matsuura H. The systemic management of cardiovascular risk patients in dentistry. *Anesth Pain Control Dent*. 1993;2(1):49-61.
- Nijjer SS, Sohaib SM, Whinnett ZI, et al. Diagnosis of supraventricular tachycardias. *Br J Hosp Med (Lond)*. 2014;75(2):C22-C25.
- Hirsh J, Guyatt G, Albers GW, et al. Antithrombotic and thrombolytic therapy: American College of Chest Physicians Evidence-Based Clinical Practice Guidelines (8th Edition). *Chest*. 2008;133(6 suppl):110S-112S.
- Patel NJ, Deshmukh A, Pant S, et al. Contemporary trends of hospitalization for atrial fibrillation in the United States, 2000 through 2010: implications for healthcare planning. *Circulation*. 2014;129(23):2371-2379.
- Garan H. Ventricular arrhythmias. In: Goldman L, Schafer A, eds. *Goldman-Cecil Textbook of Medicine*. Philadelphia: Saunders/Elsevier; 2016.
- Dukes JW, Dewland TA, Vittinghoff E, et al. Ventricular ectopy as a predictor of heart failure and death. *J Am Coll Cardiol*. 2015;66(2):101-109.
- Goldenberg I, Moss AJ. Long QT syndrome. *J Am Coll Cardiol*. 2008;51(24):2291-2300.
- Taira CA, Opezzo JA, Mayer MA, et al. Cardiovascular drugs inducing QT prolongation: facts and evidence. *Curr Drug Saf*. 2010;5(1):65-72.
- Rochford C, Seldin RD. Review and management of the dental patient with Long QT syndrome (LQTS). *Anesth Prog*. 2009;56(2):42-48.
- Mazzini MJ, Monahan KM. Pharmacotherapy for atrial arrhythmias: present and future. *Heart Rhythm*. 2008;5(6 suppl):S26-S31.
- Prystowsky EN, Padanilam BJ, Fogel RI. Treatment of atrial fibrillation. *JAMA*. 2015;314(3):278-288.
- Zipes DP. Antiarrhythmic therapy in 2014: contemporary approaches to treating arrhythmias. *Nat Rev Cardiol*. 2015;12(2):68-69.
- January CT, Wann LS, Alpert JS, et al. 2014 AHA/ACC/HRS guideline for the management of patients with atrial fibrillation: a report of the American College of Cardiology/American Heart Association Task Force on Practice Guidelines and the Heart Rhythm Society. *J Am Coll Cardiol*. 2014;64(21):e1-e76.
- Pineo G, Hull RD. Coumarin therapy in thrombosis. *Hematol Oncol Clin North Am*. 2003;17(1):201-216, viii.
- Cairns JA, Connolly S, McMurry S, et al. Canadian Cardiovascular Society atrial fibrillation guidelines 2010: prevention of stroke and systemic thromboembolism in atrial fibrillation and flutter. *Can J Cardiol*. 2011;27(1):74-90.
- Morais J, De Caterina R. Stroke prevention in atrial fibrillation: a clinical perspective on trials of the novel oral anticoagulants. *Cardiovasc Drugs Ther*. 2016;30(2):201-214.

33. Cheng JW, Barillari G. Non-vitamin K antagonist oral anticoagulants in cardiovascular disease management: evidence and unanswered questions. *J Clin Pharm Ther.* 2014;39(2):118-135.
34. Greenspon AJ, Patel JD, Lau E, et al. Trends in permanent pacemaker implantation in the United States from 1993 to 2009: increasing complexity of patients and procedures. *J Am Coll Cardiol.* 2012;60(16):1540-1545.
35. Wiber D. Electrophysiologic interventional procedures and surgery. I. In: Goldman L, Schafer A, eds. *Goldman-Cecil Textbook of Medicine.* 25 ed. Philadelphia: Saunders; 2016.
36. Gregoratos G, Abrams J, Epstein AE, et al. ACC/AHA/NASPE 2002 guideline update for implantation of cardiac pacemakers and antiarrhythmia devices: summary article. A report of the American College of Cardiology/American Heart Association Task Force on Practice Guidelines (ACC/AHA/NASPE Committee to Update the 1998 Pacemaker Guidelines). *J Cardiovasc Electrophysiol.* 2002;13(11):1183-1199.
37. Baddour LM, Bettmann MA, Bolger AF, et al. Nonvalvular cardiovascular device-related infections. *Circulation.* 2003;108(16):2015-2031.
38. Dajani AS, Taubert KA, Wilson W, et al. Prevention of bacterial endocarditis: recommendations by the American Heart Association. *J Am Dent Assoc.* 1997;128(8):1142-1151.
39. Baddour LM, Epstein AE, Erickson CC, et al. Update on cardiovascular implantable electronic device infections and their management: a scientific statement from the American Heart Association. *Circulation.* 2010;121(3):458-477.
40. Misiri J, Kusumoto F, Goldschlager N. Electromagnetic interference and implanted cardiac devices: the nonmedical environment (part I). *Clin Cardiol.* 2012;35(5):276-280.
41. Pinski SL, Trohman RG. Interference in implanted cardiac devices, part II. *Pacing Clin Electrophysiol.* 2002;25(10):1496-1509.
42. Miller CS, Leonelli FM, Latham E. Selective interference with pacemaker activity by electrical dental devices. *Oral Surg Oral Med Oral Pathol Oral Radiol Endod.* 1998;85(1):33-36.
43. Roedig JJ, Shah J, Elayi CS, et al. Interference of cardiac pacemaker and implantable cardioverter-defibrillator activity during electronic dental device use. *J Am Dent Assoc.* 2010;141(5):521-526.
44. Brand HS, Entjes ML, Nieuw Amerongen AV, et al. Interference of electrical dental equipment with implantable cardioverter-defibrillators. *Br Dent J.* 2007;203(10):577-579.
45. Brand HS, van der Hoeft EV, Schrama TA, et al. [Electromagnetic interference of electrical dental equipment with cardiac pacemakers]. *Ned Tijdschr Tandheelkd.* 2007;114(9):373-376.
46. Wilson BL, Broberg C, Baumgartner JC, et al. Safety of electronic apex locators and pulp testers in patients with implanted cardiac pacemakers or cardioverter/defibrillators. *J Endod.* 2006;32(9):847-852.
47. Garofalo RR, Ede EN, Dorn SO, et al. Effect of electronic apex locators on cardiac pacemaker function. *J Endod.* 2002;28(12):831-833.
48. Elayi CS, Lusher S, Meeks Nyquist JL, et al. Interference between dental electrical devices and pacemakers or defibrillators: results from a prospective clinical study. *J Am Dent Assoc.* 2015;146(2):121-128.
49. Kyprianou K, Pericleous A, Stavrou A, et al. Surgical perspectives in the management of atrial fibrillation. *World J Cardiol.* 2016;8(1):41-56.
50. Fleisher LA, Beckman JA, Brown KA, et al. ACC/AHA 2007 guidelines on perioperative cardiovascular evaluation and care for noncardiac surgery: a report of the American College of Cardiology/American Heart Association Task Force on Practice Guidelines (Writing Committee to Revise the 2002 Guidelines on Perioperative Cardiovascular Evaluation for Noncardiac Surgery): developed in collaboration with the American Society of Echocardiography, American Society of Nuclear Cardiology, Heart Rhythm Society, Society of Cardiovascular Anesthesiologists, Society for Cardiovascular Angiography and Interventions, Society for Vascular Medicine and Biology, and Society for Vascular Surgery. *Circulation.* 2007;116(17):e418-e499.
51. Fleisher LA, Fleischmann KE, Auerbach AD, et al. ACC/AHA guideline on perioperative cardiovascular evaluation and management of patients undergoing noncardiac surgery. *J Am Coll Cardiol.* 2014;64(22):e77-e137.
52. Fuster V, Ryden LE, Cannom DS, et al. ACC/AHA/ESC 2006 guidelines for the management of patients with atrial fibrillation: a report of the American College of Cardiology/American Heart Association Task Force on Practice Guidelines and the European Society of Cardiology Committee for Practice Guidelines (Writing Committee to Revise the 2001 Guidelines for the Management of Patients With Atrial Fibrillation): developed in collaboration with the European Heart Rhythm Association and the Heart Rhythm Society. *Circulation.* 2006;114(7):e257-e354.
53. Jafri SM. Periprocedural thromboprophylaxis in patients receiving chronic anticoagulation therapy. *Am Heart J.* 2004;147(1):3-15.
54. Jeske AH, Suchko GD. Affairs ADACoS, Division of S, Journal of the American Dental A. Lack of a scientific basis for routine discontinuation of oral anticoagulation therapy before dental treatment. *J Am Dent Assoc.* 2003;134(11):1492-1497.
55. Wahl MJ. Myths of dental surgery in patients receiving anticoagulant therapy. *J Am Dent Assoc.* 2000;131(1):77-81.
56. Aframian DJ, Lalla RV, Peterson DE. Management of dental patients taking common hemostasis-altering medications. *Oral Surg Oral Med Oral Pathol Oral Radiol Endod.* 2007;103(suppl):S45 e1-S45 e11.
57. Legrand M, Mateo J, Aribaud A, et al. The use of dabigatran in elderly patients. *Arch Intern Med.* 2011;171(14):1285-1286.
58. van Ryn J, Stangier J, Haertter S, et al. Dabigatran etexilate—a novel, reversible, oral direct thrombin inhibitor: interpretation of coagulation assays and

- reversal of anticoagulant activity. *Thromb Haemost.* 2010;103(6):1116-1127.
59. Romond KK, Miller CS, Henry RG. Dental management considerations for a patient taking dabigatran etexilate: a case report. *Oral Surg Oral Med Oral Pathol Oral Radiol.* 2013;116(3):e191-e195.
60. Mauprivez C, Khonsari RH, Razouk O, et al. Management of dental extraction in patients undergoing anticoagulant oral direct treatment: a pilot study. *Oral Surg Oral Med Oral Pathol Oral Radiol.* 2016;122(5):e146-e155.
61. Montebugnoli L, Prati C. Circulatory dynamics during dental extractions in normal, cardiac and transplant patients. *J Am Dent Assoc.* 2002;133(4):468-472.
62. Smith MM, Barbara DW, Mauermann WJ, et al. Morbidity and mortality associated with dental extraction before cardiac operation. *Ann Thorac Surg.* 2014;97(3):838-844.
63. Hersh EV, Giannakopoulos H. Beta-adrenergic blocking agents and dental vasoconstrictors. *Dent Clin North Am.* 2010;54(4):687-696.
64. Blinder D, Manor Y, Shemesh J, et al. Electrocardiographic changes in cardiac patients having dental extractions under a local anesthetic containing a vasopressor. *J Oral Maxillofac Surg.* 1998;56(12):1399-1402, discussion 402-3.
65. Blinder D, Shemesh J, Taicher S. Electrocardiographic changes in cardiac patients undergoing dental extractions under local anesthesia. *J Oral Maxillofac Surg.* 1996;54(2):162-165, discussion 65-6.
66. Cintron G, Medina R, Reyes AA, et al. Cardiovascular effects and safety of dental anesthesia and dental interventions in patients with recent uncomplicated myocardial infarction. *Arch Intern Med.* 1986;146(11):2203-2204.
67. Findler M, Galili D, Meidan Z, et al. Dental treatment in very high risk patients with active ischemic heart disease. *Oral Surg Oral Med Oral Pathol.* 1993;76(3):298-300.
68. Niwa H, Sato Y, Matsuura H. Safety of dental treatment in patients with previously diagnosed acute myocardial infarction or unstable angina pectoris. *Oral Surg Oral Med Oral Pathol Oral Radiol Endod.* 2000;89(1):35-41.
69. Bowles WH, Tardy SJ, Vahadi A. Evaluation of new gingival retraction agents. *J Dent Res.* 1991;70(11):1447-1449.
70. Kanji S, MacLean RD. Cardiac glycoside toxicity: more than 200 years and counting. *Crit Care Clin.* 2012;28(4):527-535.
71. Zambon A, Polo Friz H, Contiero P, et al. Effect of macrolide and fluoroquinolone antibacterials on the risk of ventricular arrhythmia and cardiac arrest: an observational study in Italy using case-control, case-crossover and case-time-control designs. *Drug Saf.* 2009;32(2):159-167.
72. Albert RK, Schuller JL, Network CCR. Macrolide antibiotics and the risk of cardiac arrhythmias. *Am J Respir Crit Care Med.* 2014;189(10):1173-1180.

Heart Failure (or Congestive Heart Failure)

Heart failure (HF), also known as congestive heart failure (CHF), is defined by the American College of Cardiology/American Heart Association (ACC/AHA) as a complex clinical syndrome that can result from any structural or functional cardiac disorder that impairs the ability of the ventricle to fill with or eject blood.¹ HF can be caused by a number of specific diseases (Box 6.1). It is primarily a condition of the elderly and as such is a major and growing public health problem in the United States.¹ Both the incidence and prevalence of HF are growing in the United States. The disorder is the primary reason for nearly 20 million office visits and 10 million hospital days each year.^{1,2} The number of HF deaths has increased steadily despite advances in treatment, in part because of increasing numbers of patients with HF because of the advancing age of the population and precursor conditions such as hypertension, dyslipidemia, diabetes, obesity, and cardiac arrhythmias, as well as longer term survival of people with ischemic heart disease.^{1,2}

CRITICAL COMPLICATIONS: Patients with untreated or poorly managed HF are at high risk during dental treatment for complications such as cardiac arrest, cerebrovascular accident, and myocardial infarction (MI). These events could prove fatal. The dentist must be able to detect these patients based on history and clinical findings, refer them for medical diagnosis and management, and work closely with the physician to develop a dental management plan that will be effective and safe for the patient.

EPIDEMIOLOGY

Both the incidence and prevalence of HF are growing in the United States.¹⁻³ More than 6 million persons are diagnosed with HF in the United States with more than 670,000 new cases and nearly 300,000 deaths per year. The lifetime risk of developing HF is 20% for Americans 40 years of age or older. The annual incidence of HF increases from 1 per 1000 people younger than 45 years of age to more than 10 per 1000 people older than 65 years of age. In the Medicare-eligible population, HF prevalence is over 100 per 1000 (10%).¹⁻⁴

Heart failure is significantly increasing, primarily because of advances in medical technology in preserving and maintaining life after cardiovascular events. HF is the most common Medicare diagnosis-related group (i.e.,

hospital discharge diagnosis), and more Medicare dollars are spent for the diagnosis and treatment of HF than for any other diagnosis.⁴ These figures are also true worldwide. A study from the Mayo Clinic reported a 40% increase in the incidence of HF in the past 20 years.⁴ Because it is a chronic outcome of several cardiovascular diseases over time, HF is primarily a condition of older adults. A typical dental practice serving 2000 patients would expect to treat approximately 15 to 20 individuals with HF.

PATHOPHYSIOLOGY AND COMPLICATIONS

Heart failure is not an actual diagnosis but rather represents a symptom complex that is characterized by signs and symptoms of intravascular and interstitial volume overload and/or manifestations of inadequate tissue perfusion^{2,5-7} (Fig. 6.1). The ACC/AHA 2013 Guideline Update for the Diagnosis and Management of Chronic Heart Failure in the Adult defines HF as a complex clinical syndrome that can result from any structural or functional cardiac disorder that impairs the ability of the ventricle to fill with or eject blood.^{2,5-7}

Patients with untreated or poorly managed HF are at high risk during dental treatment for complications such as cardiac arrest, cerebrovascular accident, and MI. The dentist must be able to detect these patients based on history and clinical findings, refer them for medical diagnosis and management, and work closely with the physician to develop a dental management plan that will be effective and safe for the patient.^{2,5,7}

A decline in mortality rates from HF will likely occur because of evidence-based approaches to treat it with angiotensin-converting enzyme inhibitors, beta-blockers, coronary revascularization, ICDs, and cardiac resynchronization therapeutic strategies.^{2,5-7}

Because many cases of HF go undiagnosed and patients may not be aware that they have HF, the dentist must be particularly aware of the signs and symptoms of HF (Boxes 6.2 and 6.3). HF may occur as a result of (1) impaired myocardial contractility (systolic dysfunction, commonly characterized as reduced left ventricular ejection fraction [LVEF]^{2,7,8}); (2) increased ventricular stiffness or impaired myocardial relaxation (diastolic dysfunction, which is commonly associated with a relatively normal LVEF); (3) a variety of other cardiac abnormalities, including obstructive or regurgitant valvular disease,

BOX 6.1 Most Common Causes of Heart Failure

Coronary heart disease
Hypertension
Cardiomyopathy
Valvular heart disease
Myocarditis
Infective endocarditis
Congenital heart disease
Pulmonary hypertension
Pulmonary embolism
Endocrine disease

BOX 6.2 Symptoms of Heart Failure

Dyspnea (perceived shortness of breath)
Fatigue and weakness
Orthopnea (dyspnea in recumbent position)
Paroxysmal nocturnal dyspnea (dyspnea awakening patient from sleep)
Acute pulmonary edema (cough or progressive dyspnea)
Exercise intolerance (inability to climb a flight of stairs)
Fatigue (especially muscular)
Dependent edema (swelling of feet and ankles after standing or walking)
Report of weight gain or increased abdominal girth (fluid accumulation; ascites)
Right upper quadrant pain (liver congestion)
Anorexia, nausea, vomiting, constipation (bowel edema)
Hyperventilation followed by apnea during sleep (Cheyne-Stokes respiration)

BOX 6.3 Signs of Heart Failure

Rapid, shallow breathing
Cheyne-Stokes respiration (hyperventilation alternating with apnea)
Inspiratory rales (crackles)
Heart murmur
Increased heart rate
Gallop rhythm
Increased venous pressure
Enlargement of cardiac silhouette on chest radiograph
Pulsus alternans
Distended neck veins
Large, tender liver
Jaundice
Peripheral edema
Ascites
Cyanosis
Weight gain
Clubbing of fingers

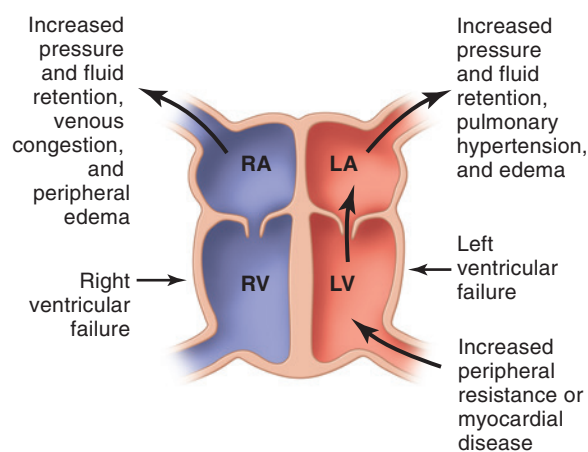

FIG 6.1 Effects of right- and left-sided heart failure. LA, Left atrium; LV, left ventricle; RA, right atrium; RV, right ventricle.

intracardiac shunting, or disorders of heart rate or rhythm; or (4) states in which the heart is unable to compensate for increased peripheral blood flow or metabolic requirements (Fig. 6.2).^{2,7-10}

Conditions that cause myocardial necrosis damage or produce chronic pressure or volume overload on the heart can induce myocardial dysfunction and HF.^{2,7-10}

Box 6.1 lists the potential causes of HF with the most common causes identified. Because HF may not be diagnosed in a dental patient, the dentist should be alerted to that possibility if the patient presents with a history of any of these underlying conditions.

The most common underlying causes of HF in the United States are coronary heart disease (secondary to atherosclerosis), hypertension, cardiomyopathy, and valvular heart disease, with coronary heart disease accounting for 60% to 75% of cases.^{2,7-10} The second most common cause of HF, accounting for about one fourth of all cases, is dilated cardiomyopathy (DCM). DCM is a syndrome characterized by cardiac enlargement with impaired systolic function of one or both ventricles, often accompanied by signs and symptoms of HF. About half of all cases of DCM have no identifiable cause and are therefore considered idiopathic. Known causes of cardiomyopathy include alcohol abuse, hereditary cardiomyopathies, and viral infections.^{2,7-10} Although hypertension is often not a primary cause of HF, it is a major contributor to HF with more than 75% of HF patients having a long-standing history of hypertension. Valvular heart disease used to be a more significant cause of HF; however, with the rates of rheumatic heart disease and congenital heart disease declining in the United States, there has been a subsequent decline in HF resulting from valvular disease.^{2,7-10} Type 2 diabetes mellitus may also be a risk for developing HF.^{9,10}

Heart failure is caused by the inability of the heart to function efficiently as a pump, which results in either an inadequate emptying of the ventricles during systole or an incomplete filling of the ventricles during diastole. This in turn results in a decrease in cardiac output with an inadequate volume of blood being supplied to the tissues or in a backup of blood, causing systemic congestion.² HF may involve one or both ventricles. Most of

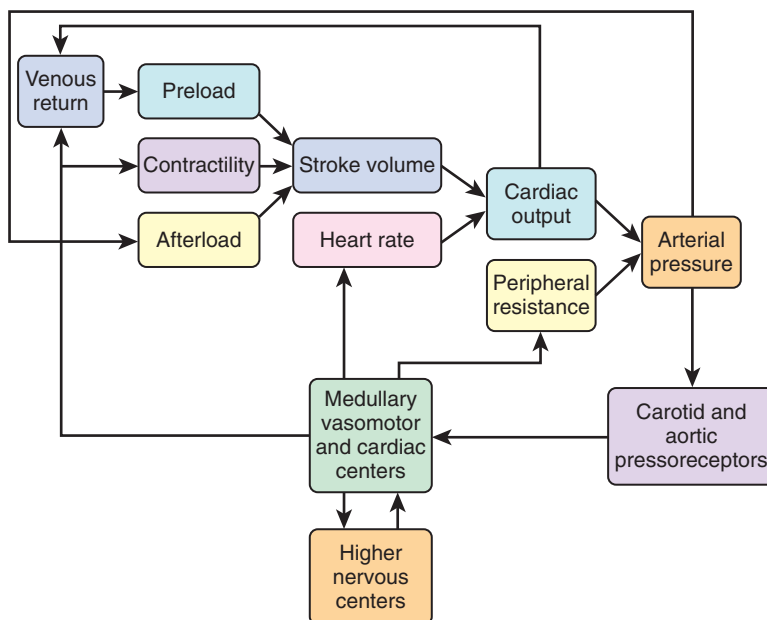

Source: Fauci AS, Kasper DL, Braunwald E, Hauser SL, Longo DL, Jameson JL, Loscalzo J: *Harrison's Principles of Internal Medicine*, 17th Edition: <http://www.accessmedicine.com>.

Copyright © The McGraw-Hill Companies, Inc. All rights reserved.

FIG 6.2 Interactions in the intact circulation of preload, contractility, and afterload in producing stroke volume. Stroke volume combined with heart rate determines cardiac output, which, when combined with peripheral vascular resistance, determines arterial pressure for tissue perfusion. The characteristics of the arterial system also contribute to afterload, an increase in which reduces stroke volume. The interaction of these components with carotid and aortic arch baroreceptors provides a feedback mechanism to higher medullary and vasomotor cardiac center and to higher levels in the central nervous system to effect a modulating influence on heart rate, peripheral vascular resistance, venous return, and contractility. (From Starling MR: *Physiology of myocardial contraction*. In Colucci WS, Braunwald E, editors: *Atlas of heart failure: cardiac function and dysfunction*, ed 3, Philadelphia, Current Medicine, 2002, pp 19-35.)

the acquired disorders that lead to HF result in initial failure of the left ventricle. Left ventricular heart failure (LVHF) often is followed by failure of the right ventricle. In adults, left ventricular involvement is almost always present even if the manifestations are primarily those of right ventricular dysfunction (fluid retention without dyspnea or rales). HF may result from an acute insult to cardiac function, such as a large MI, or, more commonly, from a chronic process.^{2,11,12} By the time most patients are seen for medical treatment, failure of both sides of the heart usually has occurred. The cardinal manifestations of HF are dyspnea and fatigue.^{2,11,12}

Heart failure can result from an acute injury to the heart such as from MI or more commonly from a chronic process such as from hypertension or cardiomyopathy. Failure of the heart most often begins with LVHF brought on by an increased workload or disease of the heart muscle.^{2,12} The determination of left ventricular failure is often based upon a finding of an abnormal *ejection fraction*, which is the percentage of blood ejected from the left ventricle during systole. Normal values for ejection fraction at rest vary between 55% and 70% (Fig. 6.3).^{2,12} Although arbitrary, an LVEF of 45% to 50% is often

used as a threshold to diagnose left ventricular failure. The outstanding symptom of left ventricular failure is dyspnea, which results from the accumulation or congestion of blood in the pulmonary vessels, thus the term *congestive* HF. Acute pulmonary edema is often the result of left ventricular failure. Left-sided HF leads to pulmonary hypertension, which increases the work of the right ventricle pumping against increased pressure and often leads to right-sided HF.^{2,12}

The most common cause of right-sided HF is preceding failure of the left ventricle. The outcomes of right ventricular failure are systemic venous congestion and peripheral edema (see Figs. 6.1 and 6.2). Failure of the right side of the heart alone is uncommon. The most common cause of pure right-sided HF is emphysema.^{2,12}

Ventricular failure leads to dilation and hypertrophy of the ventricle as it attempts to compensate for its inability to keep up with the workload. Venous pressure and myocardial tone increase along with the increase in blood volume. The net effect is diastolic dilation, which increases the force and volume of the subsequent systolic contraction. This leads to dyspnea, orthopnea, and pulmonary edema. When right-sided ventricular enlargement occurs

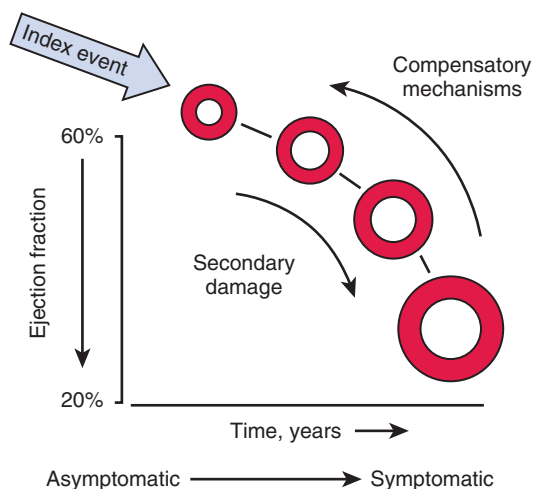

Source: Fauci AS, Kasper DL, Braunwald E, Hauser SL, Longo DL, Jameson JL, Loscalzo J: *Harrison's Principles of Internal Medicine*, 17th Edition: <http://www.accessmedicine.com>.

Copyright © The McGraw-Hill Companies, Inc. All rights reserved.

FIG 6.3 The progression of heart failure with depression of ejection fraction. Heart failure begins with a decline in the heart's pumping capacity (ejection fraction, 60%) at which time several compensatory mechanisms are activated. For a time, these compensatory mechanisms can keep the heart functioning, but over time because of increasing myocardial damage and secondary damage from other end organs, the heart's function (and ejection fraction) deteriorate. An ejection fraction of 20% is considered to be severe heart failure.

as a result of a lung disorder (e.g., emphysema) that produces pulmonary hypertension, the condition is called *cor pulmonale*.^{2,12}

The signs and symptoms of HF appear when the heart no longer functions properly as a pump. As the cardiac output falls, there is an increasing disproportion between the required hemodynamic load and the capacity of the heart to handle the load. With decreasing cardiac output, stimulation of the renin-angiotensin system and the sympathetic nervous system (neurohumoral responses) occur in an attempt to compensate for the loss of function.^{2,12} The effects of these responses include increased heart rate and myocardial contractility, increased peripheral resistance, sodium and water retention, redistribution of blood flow to the heart and brain, and an increased efficiency of oxygen utilization by the tissues. If these responses result in improved cardiac output with an elimination of symptoms, the condition is termed *compensated HF*. Symptomatic HF is termed *decompensated HF*.^{2,12}

The AHA/ACC classifies HF into four stages, reflecting the fact that HF is a progressive disease and whose outcome can be modified by early identification and treatment.¹ Stage A and B denote patients with risk factors that predispose to the development HF, such as coronary artery disease, hypertension, and diabetes but who do not have any symptoms of HF^{2,12-14} (Box 6.4).

BOX 6.4 Medical Management of Patients With Heart Failure

Stage A (Patients at High Risk for HF but Without Structural Heart Disease or Symptoms of HF)

Treatment of hypertension, encourage smoking cessation, treatment of lipid disorders, encouragement of regular exercise, discourage alcohol intake, illicit drug use, and control of metabolic syndrome

ACE inhibitors or ARBs in appropriate patients for treatment of vascular disease or diabetes

Stage B (Patients With Structural Heart Disease but Without Signs or Symptoms of HF)

All measures for stage A, plus

ACE inhibitors (or ARBs) in appropriate patients

Beta-blockers in appropriate patients

Possibly implantable defibrillators

Stage C (Patients With Structural Heart Disease With Prior or Current Symptoms of HF)

All measures for stage A and B, dietary salt restriction, plus

Drugs for routine use: diuretics, ACE inhibitors, beta-blockers

Drugs in selected patients: aldosterone antagonists, ARBs, digitalis, hydralazine, or nitrates

Devices in selected patients: biventricular pacing, implantable defibrillators

Stage D (Patients With Refractory HF Requiring Special Interventions)

Appropriate measures from stages A, B, and C

LVAD, heart transplant, chronic inotropes, permanent mechanical support, experimental drugs, or surgery

Compassionate end-of-life care or hospice

ACE, Angiotensin-converting enzyme; ARB, angiotensin receptor blocker; HF, heart failure; LVAD, left ventricular assist device.

The difference between stages A and B is that in stage A, patients do not demonstrate left ventricular hypertrophy (LVH) or dysfunction, but those in stage B do have LVH or dysfunction (structural heart disease). Stage C denotes patients with past or present symptoms of HF associated with underlying structural heart disease (the bulk of patients), and stage D designates patients with refractory HF who might be eligible for specialized, advanced treatment or for end-of-life care. This classification system complements the New York Heart Association (NYHA) classification system (Box 6.5), which is discussed in the next section.^{2,12-14} Although the mortality rates from MI and stroke are declining, HF continues to be a major cause of morbidity and mortality. In the past 20 years, the number of HF hospitalizations increased more than 165%. In the United States, approximately 56,000 deaths each year are primarily caused by HF, and it is listed as a contributing cause in 262,000 deaths.^{2,3,15,16}

The prognosis for patients with HF is poor. Of patients who survive an acute onset of HF, only 35% of men and 50% of women are alive after 5 years.^{2,3,15,16} HF is a progressive disease, and symptoms worsen over time

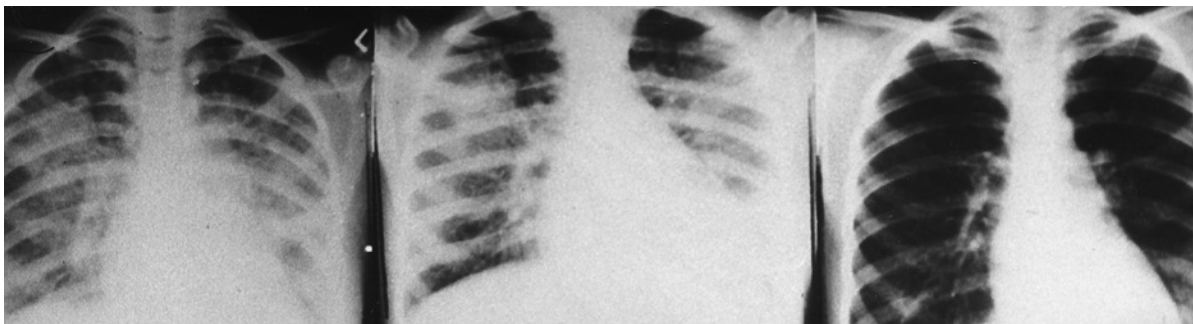

FIG 6.4 Serial chest radiographs demonstrating the resolution of pulmonary edema (*left to right*). Note the enlargement of the cardiac silhouette. (Courtesy of J. Noonan, MD, Lexington, KY.)

BOX 6.5 New York Heart Association Classification of Heart Failure

Class I: No limitation of physical activity. No dyspnea, fatigue, or palpitations with ordinary physical activity

Class II: Slight limitation of physical activity. Patients experience fatigue, palpitations, and dyspnea with ordinary physical activity but are comfortable at rest.

Class III: Marked limitation of activity. Less than ordinary physical activity results in symptoms, but patients are comfortable at rest.

Class IV: Symptoms are present with the patient at rest, and any physical exertion exacerbates the symptoms.



FIG 6.5 Distended jugular vein in a patient with heart failure.

because of the ongoing deterioration of cardiac structure and function. HF also predisposes the patient to ischemic stroke, the risk for which is twice as high as normal.¹⁷ The prognosis is better if the underlying cause can be treated. One year after the diagnosis of HF, 20% of patients will succumb to the disease. In people diagnosed with HF, sudden death occurs six to nine times the rate of the general population.^{2,3,15,16}

CLINICAL PRESENTATION

The symptoms and signs of HF (see [Boxes 6.2](#) and [6.3](#)) reflect respective ventricular dysfunction. Left ventricular failure produces pulmonary vascular congestion with resulting pulmonary edema and dyspnea. Dyspnea is the most common symptom of HF and usually is present only with exertion or physical activity. Dyspnea at rest is an indication of severe HF.^{2,12,15}

Orthopnea is positional dyspnea that is precipitated or worsened by the patient assuming a recumbent or semirecumbent position. Most patients with mild to moderate HF do not exhibit orthopnea when treated adequately. Paroxysmal nocturnal dyspnea (PND) is an attack of sudden, severe shortness of breath awakening the patient from sleep, usually within 1 to 3 hours after the patient goes to bed, and resolving within 10 to 30 minutes after the patient arises, often gasping for air. The occurrence of PND is uncommon. Both orthopnea and PND are relatively specific indicators of HF and are caused

by increased venous return encouraged by the recumbent position with resulting increase in pulmonary venous pressure and alveolar edema.^{1,2,12,15} Central regulation of respiration also may be impaired in patients with advanced HF, resulting in alternating cycles of rapid, deep breathing (hyperventilation) with periods of central apnea, called *Cheyne-Stokes respiration*. PND is a common clinical feature associated with Cheyne-Stokes respiration in patients with HF.^{1,2,12,15} Exercise intolerance is one of the hallmark symptoms of HF (e.g., inability to climb a flight of stairs) and is caused by a combination of dyspnea and reduced blood and oxygen supply to the skeletal muscles. Fatigue (especially muscle fatigue) is a common, nonspecific symptom of HF. The pulmonary examination of patients with HF is usually unremarkable. However, rales (or crackles), representing alveolar fluid, are a hallmark of HF when present. The chest radiograph may reveal enlargement and displacement of the cardiac silhouette or abnormalities of the pulmonary vasculature. Evidence of interstitial fluid or pleural effusion also may be seen ([Fig. 6.4](#)).^{1,2,12,15} Right ventricular failure results in systemic venous congestion and peripheral edema. Evidence of systemic venous congestion may be detected by the presence of distended neck veins ([Fig. 6.5](#)), a large tender liver, peripheral edema ([Fig. 6.6](#)), and ascites ([Fig. 6.7](#)). The retention of fluid results in weight gain and may increase body girth because of accumulation of fluid in

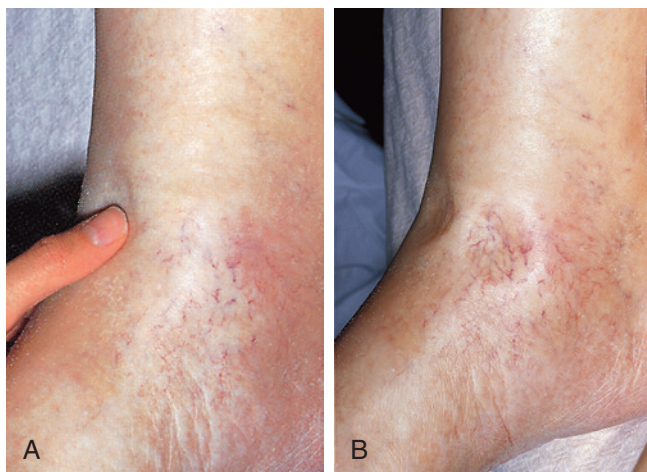

FIG 6.6 A and B, Pitting edema in a patient with heart failure. A depression (“pit”) remains in the edematous tissue for some minutes after firm fingertip pressure is applied. (From Forbes, CD, Jackson, WF: *Color atlas and text of clinical medicine*, Edinburgh, 2004, Mosby.)



FIG 6.7 Ascites. (Courtesy of P. Akers, MD, Evanston, IL.)

the peritoneal cavity. On occasion, patients with chronic HF may have clubbing of the fingers (Fig. 6.8).^{1,2,12,15}

The cardiac examination will usually reveal evidence of the underlying cardiac abnormality, as well as compensatory or degenerative changes in cardiac structure. Auscultation often reveals a laterally displaced apical impulse caused by LVH. A murmur of mitral regurgitation may be heard as well as an S₃ or S₄ gallop. Pulsus alternans, a regular rhythm with alternating strong and weak ventricular contractions, is pathognomonic of left ventricular failure but is not present in most patients with



FIG 6.8 Clubbing of the fingers in a patient with congestive heart failure.

HF. Central venous pressure increases.^{1,2,12,15} Another simple indicator of HF is increased pulse rate (tachycardia).¹⁸ Tachycardia is an indicator of increased myocardial oxygen demand, coronary blood flow, and overall myocardial performance.¹⁸ Tachycardia is known to increase adverse outcomes in patients with HF. Therefore, the dentist should be alert to alterations in heart rate as well as rhythm.

The NYHA has developed a widely used classification system of HF (see Box 6.4) that is based upon the severity of symptoms and the amount of effort needed to elicit symptoms. It is complementary to the AHA/ACC staging system described earlier and essentially is a subclassification of stage C.^{1,2,12,15}

- Class I:** No limitation of physical activity. No dyspnea, fatigue, or palpitations with ordinary physical activity.
- Class II:** Slight limitation of physical activity. These patients have fatigue, palpitations, and dyspnea with ordinary physical activity but are comfortable at rest.
- Class III:** Marked limitation of activity. Less than ordinary physical activity results in symptoms, but patients are comfortable at rest.
- Class IV:** Symptoms are present at rest, and any physical exertion exacerbates the symptoms.

LABORATORY AND DIAGNOSTIC FINDINGS

A variety of specialized tests are used to diagnose and monitor HF, depending on the cause. Among these are chest radiography, electrocardiography, echocardiography, radionuclide angiography or ventriculography, exercise stress test, ambulatory electrocardiography (Holter) monitoring, and cardiac catheterization. Measurement of systolic ejection fraction by echocardiography is helpful in the determination of the efficacy of cardiac function and therefore the level of HF^{1,2,12,15} (see Fig. 6.3). Normal cardiac function and a healthy heart result in an ejection fraction of approximately 60%. However, with continued damage to the myocardium, the efficacy of cardiac function

diminishes, and evidence of HF begins around 50%. Compensatory mechanisms and medical management will delay further HF until the myocardial damage is significantly overwhelming. Severe HF results in significant cardiac inefficiency and is indicated by an ejection fraction in the range of 20% (see Fig. 6.3).^{1,2,12,15}

Measurement of plasma hormone levels of norepinephrine, plasma atrial natriuretic peptide, and plasma renin have possible prognostic value and may be helpful clinically. Routine testing may include a complete blood count, renal function testing and electrolytes, liver function testing, blood glucose, lipids, and thyroid function testing.^{1,2,12,15}

MEDICAL MANAGEMENT

Despite advances in the care of patients with HF, outcomes are not significantly improving.^{15,19,20} The medical management of patients with HF is complex and generally applied in a graduated approach, depending on the stage (NYHA) of the disease (see Box 6.4). For stages A and B, management begins with risk reduction and includes the identification and treatment of underlying medical problems, including hypertension, atherosclerotic disease, diabetes, obesity, and metabolic syndrome (abdominal obesity, elevated blood glucose, dyslipidemia, hypertension). Fig. 6.9 illustrates the therapeutic decision-making process

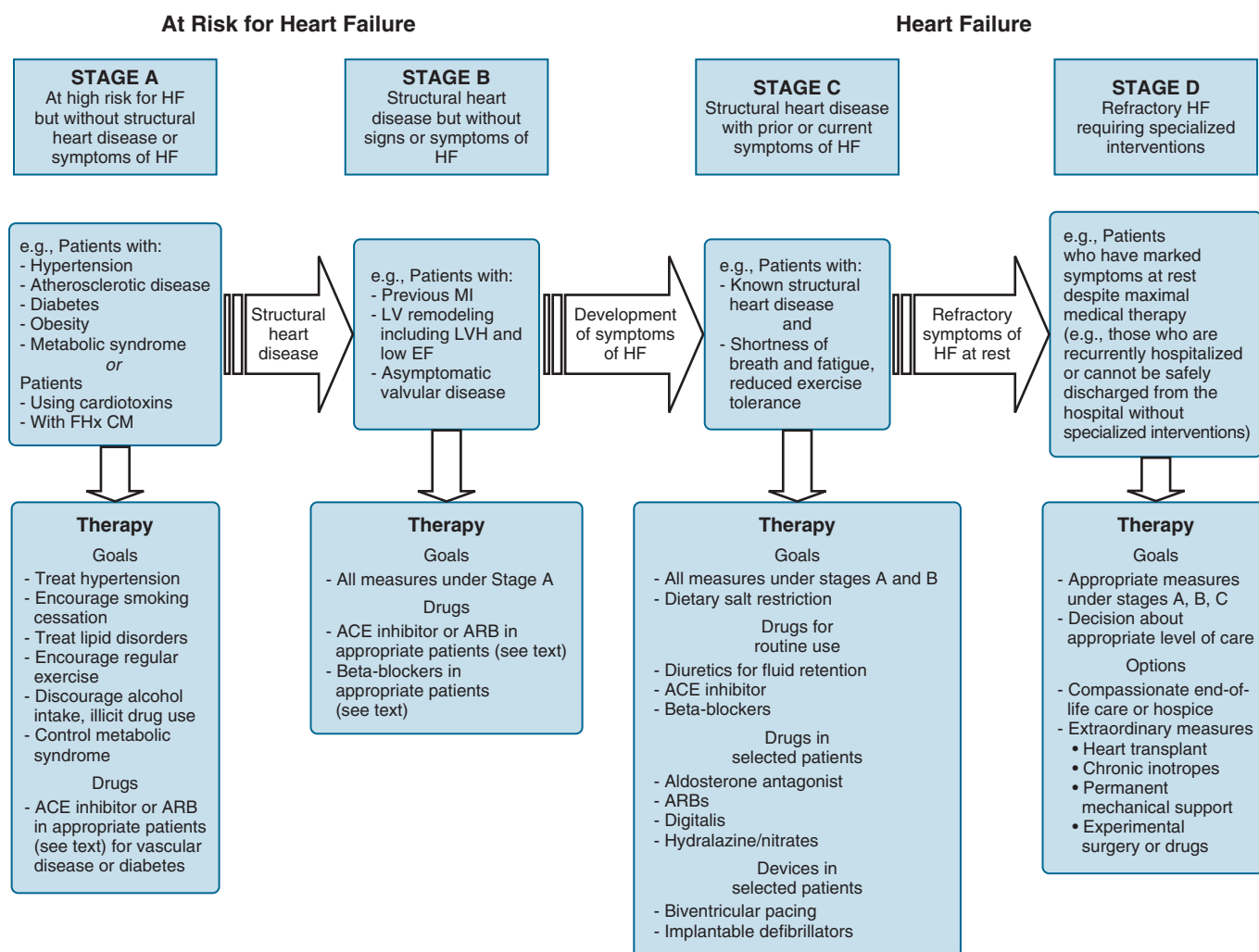

FIG 6.9 Therapeutic decision making according to stage of heart failure (HF). When a clinical diagnosis of HF is established, fluid retention should be treated before the patient starts an angiotensin-converting enzyme (ACE) inhibitor (or an angiotensin receptor blocker [ARB] if the patient is intolerant to ACE inhibitors). After fluid retention treatment, up-titration of the ACE inhibitor, or both, the patient should be started on beta-blockers. If symptoms continue, an ARB, aldosterone antagonist, or digoxin can be included as part of triple therapy. In African American patients (with New York Heart Association class II–IV HF), a fixed-dose combination of hydralazine and isosorbide dinitrate should be added to an ACE inhibitor and beta-blocker. In certain patients, device therapy may be necessary in addition to pharmacologic therapy. CM, Cardiomyopathy; EF, ejection fraction; FHx, family history; LV, left ventricular; LVH, left ventricular hypertrophy; MI, myocardial infarction. (Adapted from *Circulation* 112:1825-1852, 2014.)

according to the stage of HF. In addition, behavioral modification is promoted and includes smoking cessation, weight loss for obese patients, reduction of risk factors for cardiovascular disease, mild aerobic exercise, adequate rest, and avoidance of alcohol and illicit drugs. Unfortunately, compliance with treatment recommendations is notoriously poor.^{15,19,20} An algorithm for drug treatment for HF is shown in Fig. 6.10. Drug therapy may be indicated for the treatment of vascular disease or diabetes in stage A, as well as for ventricular dysfunction for stage B.^{1,2,12,20-27} Box 6.4 illustrates drug therapy defined by the stage of HF.

For stage C, all measures from stage A and B apply in addition to salt restriction and drug therapy (Table 6.1). Drug therapy begins with diuretics to control fluid retention (see Fig. 6.10). Several types of diuretics are used, including loop diuretics, thiazide diuretics, and potassium-sparing diuretics. Diuretics are used for three purposes: They are the only drugs that can adequately

control fluid retention, they produce more rapid symptomatic relief than other drugs, and they modulate other drugs used to treat HF. Although diuretics are effective in decreasing the signs and symptoms of fluid retention, they cannot maintain the clinical stability of patients with HF when used alone. Spironolactone, a potassium-sparing diuretic, also blocks the action of aldosterone (aldosterone antagonist) and when used in patients with class IV symptoms has been shown to reduce the risk of death by 25% to 30%. Other than spironolactone, the diuretics do not influence the natural history of chronic HF.^{1,2,12,20-27}

In addition to diuretics, drugs that modulate or decrease neurohormonal activity have become the foundation of treatment of HF. These drugs decrease the morbidity and mortality of HF by inhibiting the cardiotoxic effects of the neurohormonal system and thereby retarding the progression of HF. Several types of neurohormonal antagonists are used to treat HF, including angiotensin-converting enzyme (ACE) inhibitors, β -adrenergic blockers, and angiotensin receptor blockers (ARBs). The ACE inhibitors are quite effective and are the first-line drugs used to treat HF. ACE inhibition with enalapril has been shown to reduce mortality from HF by 20% to 40%.^{1,2,23-25}

The ACE inhibitors are typically prescribed along with or after diuretic therapy, and they decrease the need for large doses of diuretics as well as some of the adverse metabolic effects of the diuretics. The ARBs interfere with the action of angiotensin II, resulting in vasodilatation. However, although the ARBs interrupt the angiotensin pathways differently than ACE inhibitors, they are not superior to ACE inhibitors. Therefore, ARBs are typically only used in patients who cannot take ACE inhibitors. The use of beta-blockers is a cornerstone of HF therapy (in particular, bisoprolol, carvedilol, and metoprolol).^{1,2,23-25}

In addition to the ACE inhibitors, the β -adrenergic blockers are advocated, and when used in combination with the ACE inhibitors, beta-blockers appear to reduce both the risk of death or hospitalization for HF by 30% to 40%.^{1,2,23-24} The treatment algorithm for medical management of HF can be seen in Fig. 6.10.

The digitalis glycosides have been used in the treatment for HF for many years, with digoxin being the most commonly prescribed. However, with the advent of the ACE inhibitors, their use has declined. Digoxin has not been shown to decrease either the risk of death or of hospitalization, as opposed to the ACE inhibitors and beta-blockers, both of which do decrease the risk. Digoxin is, however, effective in alleviating symptoms; therefore, it is principally used to treat residual symptoms not controlled by other drugs.^{1,2,12,20-27} Digoxin is the preferred agent, however, in patients with HF who have atrial fibrillation and a rapid ventricular response. A significant problem with digitalis glycosides is their narrow therapeutic range and the resulting toxicity that easily can occur (Box 6.6).

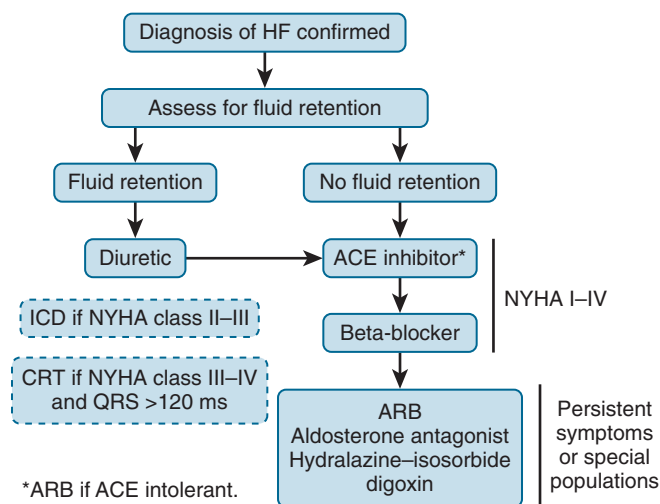

Source: Fauci AS, Kasper DL, Braunwald E, Hauser SL, Longo DL, Jameson JL, Loscalzo J: *Harrison's Principles of Internal Medicine*, 17th Edition: <http://www.accessmedicine.com>.

Copyright © The McGraw-Hill Companies, Inc. All rights reserved.

FIG 6.10 Treatment algorithm for chronic heart failure patients with a depressed ejection fraction. After the clinical diagnosis of heart failure (HF) is made, it is important to treat the patient's fluid retention before the patient starts an ACE inhibitor (or an angiotensin receptor blocker [ARB] if the patient is ACE intolerant). Beta-blockers should be started after the fluid retention has been treated, the ACE inhibitor has been uptitrated, or both. If the patient remains symptomatic, an ARB, aldosterone antagonist, or digoxin can be added as "triple therapy." The fixed-dose combination of hydralazine-isosorbide dinitrate should be added to an ACE inhibitor and beta-blocker in African American patients with New York Heart Association (NYHA) class II to IV HF. Device therapy should be considered in addition to pharmacologic therapy in appropriate patients. CRT, Cardiac resynchronization therapy; ICD, implantable cardiac defibrillator.

TABLE 6.1 Drugs Used for the Treatment of Heart Failure

Drug	Oral Adverse Effects	Dental Considerations
LOOP DIURETICS		
Bumetanide (Bumex), furosemide (Lasix), torsemide (Demadex)	Dry mouth	Orthostatic hypotension. Vasoconstrictor interactions: none
THIAZIDE DIURETICS		
Chlorothiazide (Diuril), chlorthalidone (Thalitone), hydrochlorothiazide (HCTZ), indapamide (Lozol), metolazone (Mykrox)	Dry mouth	Orthostatic hypotension. Vasoconstrictor interactions: none
POTASSIUM-SPARING DIURETICS		
Amiloride (Midamor), spironolactone (Aldactone), triamterene (Dyrenium)	Dry mouth	Orthostatic hypotension. Vasoconstrictor interactions: none
ACE INHIBITORS		
Benazepril (Lotensin), captopril (Capoten), enalapril (Vasotec), fosinopril (Monopril), lisinopril (Prinivil), moexipril (Univasc), perindopril (Coversyl), quinapril (Accupril), ramipril (Altace),trandolapril (Mavik)	Angioedema of the lip, face, or tongue; taste changes; burning mouth; lichenoid reactions	Orthostatic hypotension; avoid prolonged use of NSAIDs. Vasoconstrictor interactions: none
ANGIOTENSIN RECEPTOR BLOCKERS		
Candesartan (Atacand), eprosartan (Teveten), irbesartan (Avapro), losartan (Cozaar), olmesartan (Benicar), telmisartan (Micardis), valsartan (Diovan)		Orthostatic hypotension. Vasoconstrictor interactions: none
ALDOSTERONE INHIBITORS		
Eplerenone (Inspra), spironolactone (Aldactone)		Orthostatic hypotension. Vasoconstrictor interactions: none
BETA-BLOCKERS		
Acebutolol (Sectral) (CS), atenolol (Tenormin) (CS), betaxolol (Kerlone) (CS), bisoprolol (Zebeta) (CS), carteolol (Cartrol) (NS), carvedilol (Coreg) (NS/ α blocker), labetalol (Normodyne) (CS), metoprolol (Lopressor) (CS), nadolol (Corgard) (NS), penbutolol (Levatol) (NS), pindolol (Visken) (NS), propranolol (Inderal) (NS), timolol (Blocadren) (NS)	Lichenoid reactions	Orthostatic hypotension; avoid long-term use of NSAIDs Possible increase in BP is possible with NS beta-blockers; cautious use of vasoconstrictors is recommended (maximum, 0.036 mg of epinephrine; 0.20 mg of levonordefrin) With CS beta-blockers, use vasoconstrictors normally
DIGITALIS		
Digoxin (Lanoxin)	Increased gag reflex; hypersalivation (sign of toxicity)	Increased risk for arrhythmias; avoid vasoconstrictors if possible
VASODILATORS		
Hydralazine (Apresoline), isosorbide dinitrate (Isordil)	Lupus-like oral lesions, lymphadenopathy, dry mouth	Orthostatic hypotension. Vasoconstrictor interactions: none

ACE, Angiotensin-converting enzyme; BP, blood pressure; CS, cardioselective; NS, nonselective; NSAID, nonsteroidal antiinflammatory drug.

Other drugs used to treat patients with HF unresponsive to ACE inhibitors include angiotensin receptor blockers and direct-acting vasodilators (hydralazine, isosorbide dinitrate). This approach of combination hydralazine–isosorbide dinitrate has shown particular efficacy in patients with significantly reduced ejection fractions.^{25,26}

For all patients with HF, drugs that are known to worsen the clinical status should be avoided. These include nonsteroidal antiinflammatory drugs (NSAIDs), most antiarrhythmic drugs, and calcium channel blockers. In selected patients, other nonpharmacologic measures may be indicated, including biventricular pacing or the use of

BOX 6.6 Clinical Manifestations of Digitalis Toxicity

Headache, nausea, vomiting
 Hypersalivation
 Altered vision and color perception
 Fatigue, malaise, drowsiness
 Arrhythmias (tachycardias or bradycardias)

an implantable defibrillator.^{1,2,12} Because of the deterioration of renal function in patients with HF, therapy aimed at counterregulatory responses mediated by adenosine might be promising. Recently randomized clinical trials have been conducted with rolofylline, an adenosine A1-receptor agonist. Likewise, another new approach has been with renin–angiotensin–aldosterone system blockers (angiotensin receptor–neprilysin inhibitor) for HF with reduced ejection fraction. Clinical trials with this agent demonstrated improvement in HF outcomes when used in combination with ACE inhibitors or ARBs.²³⁻²⁷

As with many conditions, a large degree of success of medical therapy depends on patient compliance with treatment recommendations. Because many of these patients are treated with a plethora of drugs, it is important to monitor and encourage their compliance. However, a relatively recent study has demonstrated that even after telemonitoring and multiple verbal reminders, the overall impact on improving outcomes in HF was not significant.¹⁹ If drug therapy is found to be inadequate to control the patient with severe, refractory HF (stage D), mechanical and surgical intervention may be provided. These measures may include intraaortic balloon counterpulsation, left ventricular assist device (LVAD), and heart transplantation. Patients with long-term LVADs are likely to require dental treatment. Two types of assist systems are available: pulsating and nonpulsating. The pulsating pump devices mimic the natural pulsing action of the heart and include the Novacor (Miami, FL) and HeartMate (Thoratec; Pleasanton, CA) XVE pumps. The nonpulsating are the continuous centrifugal or axial flow devices, such as the Incor (Berlin Heart; Berlin, Germany), Jarvik 2000 (New York, NY), and Micromed DeBakey (Houston, TX). A second-generation ventricular assist device is the nonpulsatile type that is built as an axial electromagnetic driven flow pump. The HeartMate II (Thoratec, Pleasanton, CA) is such a device, and the first implantation was performed in 2000.²⁸ LVADs are similar to an extended heart valve; therefore, antibiotic prophylaxis should be considered.²⁹

Implantable cardioverter-defibrillator (ICD) therapy has demonstrated benefits in treating HF patients in NYHA class II or III.²⁹⁻³¹ When cardiac resynchronization therapy is added to ICD, the mortality and morbidity in patients with HF are improved.³² The final measure is end-of-life care with hospice.^{1,12,15,16} Recently, improvements in

continuous-flow LVADs have demonstrated significant improvements in survival of patients with HF as well as quality of life and functional capacity.^{1,21,26,28,30}

DENTAL MANAGEMENT

Identification. Identification of patients with a history of HF, those with undiagnosed HF, or those prone to developing HF is the first step in risk assessment and in avoiding an untoward event. It should be recalled that HF is a symptom complex that is the end result of an underlying disease such as coronary heart disease, hypertension, or cardiomyopathy; therefore, the cause of HF must be identified with steps taken for appropriate dental management. Identification is accomplished by obtaining a thorough medical history, including a pertinent review of systems, and taking and evaluating the vital signs (pulse rate and rhythm, blood pressure [BP], respiratory rate). All medications being taken should be identified as well. In a review of systems, patients should be asked about the presence of signs or symptoms related to the cardiovascular and pulmonary systems. Patients reporting shortness of breath, orthopnea, PND, fatigue, or exercise intolerance may have HF or other cardiovascular disease. A report of an inability to climb a flight of stairs without shortness of breath or fatigue may reflect poor functional capacity or diminished cardiopulmonary reserve, with an increased risk of adverse outcome. Patients with a previous history of HF or who are asymptomatic have *compensated* HF (NYHA I). Those who are symptomatic have *decompensated* HF (NYHA II, III, and IV) (see Box 6.4).^{1,2,12,21,22}

Risk Assessment. The dentist must make a determination of the risk involved in providing dental treatment to a patient with HF and to decide if the benefits of treatment outweigh the risk. This often requires consultation with the patient's physician. The ACC and the AHA¹ have published guidelines that can help to make this determination. These guidelines are intended for use by physicians who are evaluating patients with cardiovascular disease to determine if they can safely undergo surgical procedures. They also can be applied to the provision of dental care and be of significant value to the dentist in making a determination of risk.⁵

Recently, a study by Smith et al indicated a significantly higher risk of serious adverse outcomes of patients undergoing elective heart surgery if they had a tooth extracted within 30 days of the surgery. A total of 3% of those patients died, and another 8% had serious adverse events. Therefore, caution should be exercised in performing extractions in dental patients before cardiac surgery.³³

The guidelines suggest that patients with decompensated HF constitute a major risk for the occurrence of a serious event (acute MI, unstable angina, or sudden death) during treatment.¹ Thus, patients with symptoms of HF (decompensated; NYHA class II, III, or IV) generally are not candidates for elective dental care, and treatment should

BOX 6.7 Dental Management of the Patient With Heart Failure

P Patient Evaluation and Risk Assessment (see Box 1.1) P: Patient Evaluation to Determine the Nature, Severity, Control, and Stability of Disease		C	
Potential Issues or Concerns			
A		D	
Antibiotics	Patients may be more susceptible to infection (leukopenia), but usually this is not a problem. There is no need for antibiotic prophylaxis unless there is an underlying prosthetic heart valve or other cardiac conditions (refer to AHA guidelines).	Chair position	If hypotensive and syncopal because of cardiac stress and pulmonary congestion, the patient may not tolerate a supine position.
Anesthesia	It is very important to administer good anesthesia to reduce stress and cardiac crisis. Epinephrine (1:100,000 and no more than 2 carpules) in local anesthetics is generally no problem, but patients should be monitored closely. Clinicians should provide good postoperative pain control. General anesthesia should be avoided.	Consultation	If hypotensive and syncopal because of cardiac stress and pulmonary congestion, the patient may not tolerate a supine position or medical management; the dental treatment plan is unaffected. However, consultation with the patient's physician to establish the level of control (e.g., ejection fraction) is recommended.
Analgesics	Use caution with NSAIDs, which can exacerbate HF.	E	
Anxiety	Untreated or poorly controlled patients may appear very anxious and stressed and possibly undergo cardiac crisis. It is important to control the heart rate. It may be necessary to use special anxiety and stress reduction techniques (see Chapter 1).	Devices	These patients may have pacemakers, implanted defibrillators, LVADs, or prosthetic valves in which case the guidelines should be followed.
B		Drugs	These patients are typically taking many medications. Be aware of side effects, interactions, and so on. Use caution with NSAIDs, which can exacerbate HF. The use of epinephrine or other pressor amines (gingival retraction cords or to control bleeding) must be avoided.
Bleeding	Excessive bleeding may occur because most of these patients will be taking anticoagulants (e.g., Coumadin, clopidogrel).	Equipment	BP and pulse oximetry monitoring may be necessary.
Blood pressure (BP)	Monitor BP because it may significantly increase or decrease in poorly controlled patients. Monitor BP and blood loss throughout procedure. If BP drops below 100/60 mm Hg and the patient is unresponsive to fluid replacement and vasopressive measures, seek immediate medical attention.	Emergencies	Patients undergoing a cardiac crisis may progress to cardiac arrest and need to be treated as a medical emergency, and 911 may need to be called. If the patient is ambulatory and stable, he or she should seek urgent medical care. Ongoing vital signs must be monitored and CPR initiated; if necessary, transport the patient to emergency medical facilities.
		F	
		Follow-up	Dialogue with the patient to determine the disease severity and level of control

AHA, American Heart Association; CPR, cardiopulmonary resuscitation; HF, heart failure; LVAD, left ventricular assist device; NSAID, nonsteroidal antiinflammatory drug.

be deferred until medical consultation can be obtained (Box 6.7). Patients who have a history of HF but who are asymptomatic (compensated; NYHA class I) constitute an intermediate risk for a serious event occurring. With good functional capacity and reserve (i.e., can climb a flight of stairs; see Chapter 1), however, they can generally undergo any required treatment with little likelihood of problems. Thus, patients who are NYHA class I can receive routine outpatient dental care. However, the dentist should be aware that even these HF patients with NYHA class I should not be considered “mild” because they indeed

could be decompensated during dental treatment.^{1,2,5,30,31,33} Many patients who are NYHA class II and some class III also may undergo routine treatment in an outpatient setting after approval by their physician. However, it is very important to realize that even the patients who have compensated HF may become decompensated during a dental procedure. The most common reason for this happening is failure to take their medications properly. Therefore, the dentist must be aware, monitor them closely, inquire about medication compliance, and be prepared for an emergency.^{1,2,5,30,31,33}

The remaining NYHA class III patients and all class IV patients are best treated in a special care facility such as a hospital dental clinic with continuous monitoring.

In most cases of HF, it is necessary for the dentist to obtain a medical consultation with the patient's cardiologist to determine the patient's physical status, laboratory test results, level of control, compliance with medications and recommendations, and overall stability.^{1,2,5,30,31,33}

Recommendations (see Box 6.7)

Antibiotics. There is no need for antibiotic prophylaxis unless there is an underlying prosthetic heart valve or other cardiac conditions (refer to AHA guidelines). LVADs are similar to an extended heart valve; therefore, antibiotic prophylaxis should be considered.²⁹

Anxiety. Recommendations for management include short, stress-free appointments (see Box 6.7). Untreated or poorly controlled patients may appear very anxious and stressed and possibly undergo cardiac crisis. It may be necessary to use special anxiety and stress reduction techniques.

Analgesics. See D below; also see Chapter 1.

Bleeding. Excessive bleeding may occur because most of these patients will be taking anticoagulants (e.g., Coumadin, clopidogrel). Bleeding may be more pronounced immediately postoperatively (LVAD implantation).^{29,30}

Blood Pressure. Monitor BP because it may significantly increase or decrease in poorly controlled patients. Monitor BP and blood loss throughout the procedure. If the BP drops below 100/60 mm Hg and the patient is unresponsive to fluid replacement and vasopressive measures, seek immediate medical attention.

Chair Position. Patients with HF may not tolerate a supine chair position because of pulmonary edema and need a semisupine or upright chair position. If the patient is hypotensive and syncopal because of cardiac stress and pulmonary congestion, he or she may not tolerate a supine position.

Consultation. If under good medical management, the dental treatment plan is unaffected. However, consultation with the patient's physician to establish the level of control (e.g., ejection fraction) is recommended.

Drug Considerations. Before administering any medications to these patients, drug-drug interactions should be checked and avoided. Patients with heart failure are typically on many medications.

It is very important to administer good anesthesia to reduce stress and cardiac crisis. Epinephrine (1:100,000 and no more than 2 carpules) in local anesthetics is generally no problem, but patients should be monitored closely. Clinicians should provide good postoperative pain control. General anesthesia should be avoided.

For patients who are NYHA class III or IV, vasoconstrictors should be avoided; however, if their use is considered essential, it should be discussed with the physician. Generally, epinephrine in moderate doses is well tolerated even in patients with advanced HF.³⁴ If it is considered

essential to use epinephrine, it should be used cautiously. A maximum of 0.036 mg of epinephrine (i.e., two cartridges of 2% lidocaine with 1:100,000 epinephrine) is recommended, taking care to avoid inadvertent intravascular injection. Epinephrine-impregnated gingival retraction cord should be avoided.^{5,32,35-37}

For patients taking a digitalis glycoside (digoxin), epinephrine should be avoided, if possible, because the combination can potentially precipitate arrhythmias.^{5,32,35-37}

Patients should be observed for signs of digitalis toxicity, such as hypersalivation. If toxicity is suspected, patients should promptly be referred to their physician. NSAIDs should be avoided because they can exacerbate symptoms of HF. Nitrous oxide plus oxygen sedation can be used if adequate O₂ flow (at least 30%) is maintained. Supplemental low-flow oxygen alone may also be used.^{5,32,35-37}

Most common NSAIDs can exacerbate HF with a relative risk of 1.4 times normal. Celecoxib and particularly rofecoxib are significantly more likely to exacerbate HF with more than twice the risk.³² Consequently, dentists should be aware and cautious regarding the use of NSAIDs for managing pain in patients with HF.

Devices. Patients who have HF may have pacemakers, implanted defibrillators, LVADs, or prosthetic valves in which case the guidelines should be followed (see Chapters 2 and 5). There is little evidence that electromagnetic interference from dental instruments is a problem, but it should be considered. Because patients with LVADs have first priority for heart transplantation, only emergency dental treatment should be encouraged.

Equipment. BP and pulse oximetry monitoring may be necessary.

Emergencies. Patients undergoing a cardiac crisis may progress to cardiac arrest and need to be treated as a medical emergency, and 911 may need to be called; if the patient is ambulatory and stable, he or she should seek urgent medical care. Ongoing vital signs must be monitored and cardiopulmonary resuscitation initiated; if necessary, the patient should be transported to emergency medical facilities.

ORAL MANIFESTATIONS AND COMPLICATIONS

In general, patients with HF who are under good medical management can receive any indicated dental treatment as long as the dental management plans deal effectively with the problems presented by the HF, its underlying cause, and the effects of the medications. Patients with symptomatic HF present a definite challenge that mandates specific management considerations.

There are no oral manifestations related to HF per se; however, many of the drugs used to manage HF can cause dry mouth and oral lesions (see Table 6.1). Digitalis may exaggerate the patient's gag reflex and can cause hypersalivation when high serum levels occur.^{36,37}

REFERENCES

1. Yancy CW, Jessup M, Bozkurt B, et al. 2013 ACCF/AHA guidelines for the management of heart failure. *J Am Coll Cardiol*. 2013;62(10):147-239.
2. Massie B, Goldman L, Schafer AI, eds. *Cecil Textbook of Medicine*. 24th ed. Philadelphia, PA, USA: Elsevier; 2012:608-622 [Chapter 58, 59]. ISBN 978-1-4377-1604-7.
3. Sacks CA, Jarcho JA, Curfman GD. Paradigm shifts in heart failure—a timeline. *N Engl J Med*. 2014;371(11):989-991.
4. Kalogeropoulos A, Georgiopoulou V, Kritchevsky SB. Epidemiology of incident heart failure. *Arch Intern Med*. 2009;169(7):708-714.
5. Herman WW, Ferguson HW. Dental care for patients with heart failure: an update. *J Am Dent Assoc*. 2010;141(7):845-853.
6. Metra M, Zacà V, Parati G, et al; Heart Failure Study Group of the Italian Society of Cardiology. Cardiovascular and noncardiovascular comorbidities in patients with chronic heart failure. *J Cardiovasc Med (Hagerstown)*. 2011;12(2):76-84.
7. Horsley L. American Heart Association update of heart failure guidelines. *Am Fam Physician*. 2011;81(5):654-665.
8. Owen TE, Hodge D, Herges RM, et al. Trends in prevalence and outcome of heart failure with preserved ejection fraction. *N Engl J Med*. 2006;355(3):251-262.
9. Khalaf KI, Taegtmeier H. Insulin sensitizers and heart failure: an engine flooded with fuel. *Curr Hypertens Rep*. 2010.
10. Leung AA, Eurich DT, Lamb DA, et al. Risk of heart failure in patients with recent-onset type 2 diabetes: population-based cohort study. *J Card Fail*. 2009;15(2):152-157.
11. Alattar FT, Imran N, Debari VA, et al. Fractional excretion of sodium predicts worsening renal function in acute decompensated heart failure. *Exp Clin Cardiol*. 2010;15(3):e65-e69.
12. Mann DL. Heart failure and cor pulmonale. In: Fauci B, Kasper A, et al, eds. *Harrison's Principles of Internal Medicine*. NY: McGraw-Hill; 2008:1442-1499.
13. Timoteo AT, Ramos R, Toste A, et al. Impact of obesity on results after primary angioplasty in patients with ST segment elevation acute myocardial infarction. *Rev Port Cardiol*. 2010;29(6):999-1008.
14. Stevenson LW, Zile M, Bennett TD, et al. Chronic ambulatory intracardiac pressures and future heart failure events. *Circ Heart Fail*. 2010;3(5):580-587.
15. Fonarow GC, Albet NM, Curtis AB, et al. Improving evidence-based care for heart failure. *Circulation*. 2010;122:585-595.
16. Maggioni AP, Anker SD. Are hospitalized or ambulatory patients with heart failure treated in accordance with the European Society for Cardiology guidelines? *Eur J Heart Fail*. 2013;15:1173-1189.
17. Katsanos AH. Heart failure and the risk of ischemic stroke recurrence: a systematic review and meta-analysis. *J Neurol Sci*. 2016;361:172-178.
18. Shaaya G, Al-Khazaali A, Rohit M. Heart rate as a biomarker in heart failure. *Am J Ther*. 2015;10:[Epub ahead of print].
19. Chaundry S, Mattera J, Curtis JP, et al. Telemonitoring in patients with heart failure. *N Engl J Med*. 2010;363(24):2301-2311.
20. Waterworth S, Gott M. Decision making among older people with advanced heart failure as they transition to dependency and death. *Curr Opin Support Palliat Care*. 2010;18(4):266-272.
21. Jessup M. Defining success in heart failure: the end-point mess. *Circulation*. 2010;121(18):1977-1980.
22. Agha SA, Kalogeropoulos AP, Shih J, et al. Echocardiography and risk prediction in advanced heart failure: incremental value over clinical markers. *J Card Fail*. 2009;15(7):586-592.
23. McMurray JJV. Angiotensin-neprilysin inhibition versus enalapril in heart failure. *N Engl J Med*. 2014;371(11):993-1005.
24. McMurray JJV, Packer M, Desai AS. Dual angiotensin receptor and neprilysin inhibition as an alternative to ACEI in person with chronic systolic heart failure. *Eur J Heart Fail*. 2013;15:1062-1069.
25. Travessa AM, Menezes Falcao LF. Treatment of heart failure with reduced ejection-fraction-recent developments. *Am J Ther*. 2016;23(2):531-549.
26. Xie W, Zheng F, Song X, et al. Renin-angiotensin-aldosterone system blockers for heart failure with reduced ejection fraction or left ventricular dysfunction: network meta-analysis. *Int J Cardiol*. 2016;205:65-71.
27. Khazanie P. Clinical effectiveness of hydralazine-isosorbide dinitrate therapy in patients with heart failure and reduced ejection fraction—findings from the Get with the Guidelines-Heart Failure registry. *Circulation*. <http://www.mdlinx.com/internalmedicine/print-preveiw.cfm/6545707>.
28. Loyaga-Rendon RY, Acharya D, Pamboukian SV, et al. Duration of heart failure is an important predictor of outcomes after mechanical circulatory support. *Circ Heart Fail*. 2015;8(5):953-959.
29. Findler MD, Findler M, Rudis E. Dental treatment of a patient with an implanted left ventricular assist device: expanding the frontiers. *Oral Surg Oral Med Oral Pathol Oral Radiol Endod*. 2011;111:e1-e4.
30. Uhlig K, Balk EM, Earley A, et al. Assessment on implantable defibrillators and the evidence for primary prevention of sudden cardiac death. A report from the Agency for Healthcare Research and Quality. Rockville, MD; June 2014.
31. Tang A, Wells G, Talajuc M, et al. Cardiac resynchronization therapy for mild-to-moderate heart failure. *N Engl J Med*. 2010;363(25):2385-2392.
32. Ungprasert P. Nonsteroidal anti-inflammatory drugs and the risk for heart failure. *Eur J Intern Med*. 2015;22(6):763-774.
33. Smith MM, Barbara DW, Mauermann WJ, et al. Morbidity and mortality associated with dental extraction before cardiac operation. *Ann Thorac Surg*. 2014;97:838-844.

34. Sochalski J, Jaarsma T, Krumholtz HM, et al. What works in chronic care management: the case of heart failure. *Health Aff.* 2009;28(1):179-189. doi:10.1377/hlthaff.28.1.179.
35. Friedlander AH, Yoshikawa TT, Chang DS, et al. Atrial fibrillation: pathogenesis, medical-surgical management and dental implications. *J Am Dent Assoc.* 2009;140(2):167-177, quiz 248.
36. Conrado VC, Andrade J, de Angelis GA, et al. Cardiovascular effects of local anesthesia with vasoconstrictor during dental extraction in coronary patients. *Arq Bras Cardiol.* 2007;88(5):507-513.
37. House AA. Pharmacological therapy of cardiorenal syndromes and heart failure. *Contrib Nephrol.* 2010;164:164-172.

PART III

Pulmonary Disease

Pulmonary Disease

Chronic obstructive pulmonary disease (COPD), which includes bronchitis and emphysema, and chronic lower respiratory disease (COPD and asthma), are common pulmonary diseases that cause obstruction in airflow. They are discussed in this chapter along with tuberculosis (TB), the most prevalent contagious disease in the world. Dental practitioners should be aware that pulmonary diseases pose several dental management considerations including risk for acute and chronic airway and breathing issues, as well as risk of disease (i.e., TB) spread.

CHRONIC OBSTRUCTIVE PULMONARY DISEASE

Chronic obstructive pulmonary disease is a general term for pulmonary disorders characterized by chronic airflow limitation from the lungs that is not fully reversible.¹ COPD encompasses two main diseases: chronic bronchitis and emphysema. *Chronic bronchitis* is defined as a condition associated with chronic inflammation of the bronchi that produces excessive tracheobronchial mucus production (at the bronchial level) and a persistent cough with sputum for at least 3 months in at least 2 consecutive years in a patient in whom other causes of productive chronic cough have been excluded. *Emphysema* is defined as a permanent enlargement of the air spaces in the lung (e.g., distal to the terminal bronchioles) that is accompanied by destruction of the air space (alveolar) walls without obvious fibrosis.¹ These conditions are related, often represent the progression of disease, and may have overlapping symptoms, making differentiation difficult. Accordingly, experts have recommended use of the designation COPD over the traditional terms chronic bronchitis and emphysema. COPD currently is diagnosed on the basis of the presence of cough, sputum production, and dyspnea together with an abnormal measurement of lung function.²

EPIDEMIOLOGY

Chronic obstructive pulmonary disease is the third leading cause of death in the United States and is estimated to affect more than 24 million people.³ COPD affects approximately 5% of adults and about 10% of persons older than 45 years in the United States.¹ About 70% of cases occur in people older than age 45 years. The disease is more common in women; however, the death

rate is 1.3 times greater in men than women (48.6 vs 36.6 per 100,000).⁴ COPD is disabling, second only to arthritis as the leading cause of long-term disability and functional impairment. Prevalence, incidence, and hospitalization rates increase with age.⁵ The disease is underdiagnosed in most populations. On the basis of current figures, the average dental practice of 2000 patients is estimated to have about 100 patients who experience features of COPD.

ETIOLOGY

Worldwide, the most important cause of COPD is tobacco smoking. Approximately 12.5% of current smokers, 9% of former smokers, and 8% of those exposed to passive smoke have COPD.^{5,6} Smoking also accounts for 85% to 90% of COPD-related deaths in both men and women.⁷ The risk for development of COPD is dose related and increases with the number of cigarettes smoked per day and duration of smoking.⁸ The risk of death from COPD is 13 times higher in female smokers and 12 times higher in male smokers than in nonsmokers of the same gender.^{9,10} Despite the increased risk, only about one in five chronic smokers develops COPD. This observation suggests that genetic susceptibility to the production of inflammatory mediators (i.e., cytokines) in response to smoke exposure plays an important role. In addition to cigarette smoking, long-term exposure to occupational and environmental pollutants and the absence or deficiency of α_1 -antitrypsin are factors that contribute to COPD. The enzyme α_1 -antitrypsin is made in the liver and neutralizes neutrophil elastase.

PATHOPHYSIOLOGY AND COMPLICATIONS

Chronic exposure to cigarette smoke induces pathophysiologic responses of the airways and lung tissue. Chronic bronchitis involves the large and small airways. In the large airways, tobacco smoke and irritants induce thickened bronchial walls with inflammatory cell infiltrate, increased size of the mucous glands, and goblet cell hyperplasia. Obstruction is exacerbated in the small airways by narrowing, scarring, increased sputum production, mucous plugging, and collapse of peripheral airways resulting from the loss of surfactant¹ (Fig. 7.1). Obstruction is present on both inspiration and expiration.

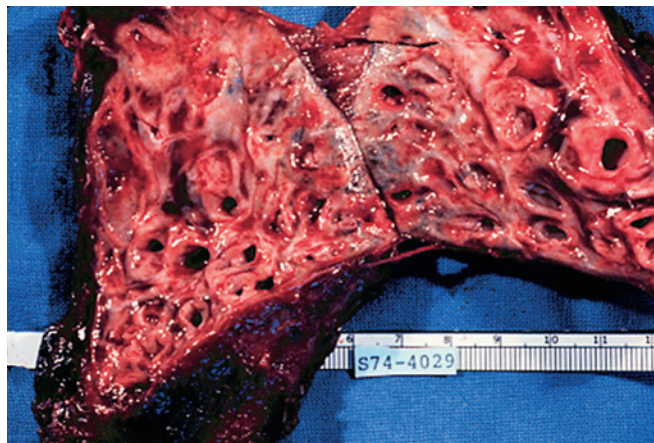

FIG 7.1 Gross pathologic specimen shows lung changes (thickened bronchial walls, narrowing of small airways) caused by chronic bronchitis. (Courtesy of McLay RN, Wells: *Tulane gross pathology tutorial*, Tulane University School of Medicine, New Orleans, LA, 1997.)

Emphysematous changes occur as chronic smoke inhalation injures lung parenchyma. The alveolar epithelium is damaged, causing a release of inflammatory mediators that attract activated macrophages and neutrophils. These inflammatory cells release enzymes (elastase) that destroy the alveolar walls, resulting in enlarged air spaces distal to the terminal bronchioles and loss of elastic recoil of the lungs (Fig. 7.2). Obstruction is caused by the collapse of these unsupported and enlarged air spaces and is evident on expiration, not inspiration.¹

Chronic obstructive pulmonary disease usually is progressive, and the course is one of deterioration and periodic exacerbations unless intervention is provided early in its onset.⁸ The types of complications that develop vary depending on the site of damage. With continued exposure to primary etiologic factors (cigarette smoking, environmental pollutants), COPD usually results in progressive dyspnea and hypercapnia to the point of severe debilitation (clinically significant disability will develop in 15% to 20% of the patients).⁷ Recurrent pulmonary infections with *Haemophilus influenzae*, *Moraxella catarrhalis*, and *Streptococcus pneumoniae* are especially common with bronchitis. These acute exacerbations are managed with antibiotics. Pulmonary hypertension can develop and, in the absence of supplemental oxygen therapy, lead to cor pulmonale (right-sided heart failure). Patients with emphysema more frequently are found to have enlarged air spaces, with a higher incidence of thoracic bullae and pneumothorax. Poor quality of sleep secondary to nocturnal hypoxemia is common with COPD. Also, coexisting hypertension, ischemic heart disease and risk of arrhythmia, heart failure, and myocardial infarction (MI) as well as muscle wasting and osteoporosis occur in persons with COPD.^{11,12}

BOX 7.1 Predominant Findings in Patients With Chronic Obstructive Pulmonary Disease

History: Exposure to risk factors, reduced exercise capacity

Clinical: Cough, sputum production, exertional dyspnea

Laboratory: Spirometry revealing airflow limitation, blood gas abnormalities

Imaging: Chest radiography or computed tomography scan revealing prominent bronchovascular markings or evidence of hyperinflation

- *Features of chronic bronchitis:* onset at the age of approximately 50 years, overweight, chronic productive cough, copious mucopurulent sputum, mild dyspnea, frequent respiratory infections, elevated PCO_2 , decreased PO_2 (hypoxia), cor pulmonale, chest radiograph showing prominent blood vessels and large heart
- *Features of emphysema:* onset at the age of approximately 60 years, thin physique, barrel chested, seldom coughing, scanty sputum, severe dyspnea, few respiratory infections, normal PCO_2 , decreased PO_2 , chest radiograph showing hyperinflation and small heart

CLINICAL PRESENTATION

Signs and Symptoms

The onset phase of COPD takes many years in most patients and usually begins after age 40 years. Symptoms develop slowly, and many patients are unaware of the emerging condition. Key indicators are a chronic cough with sputum production that may be intermittent, unproductive or productive, and scanty or copious and dyspnea that is persistent and progressive or worsens with exercise. As the disease progresses, weight loss and decreased exercise capacity also are seen. Comorbid conditions include cardiovascular disease, respiratory infections, osteoporosis, and fractures.⁹

Traditionally, patients with chronic bronchitis have been described as sedentary, overweight, cyanotic, edematous, and breathless; accordingly, they have been known as “blue bloaters.” Patients diagnosed with emphysema were traditionally known as “pink puffers” because they demonstrated enlarged chest walls (i.e., “barrel-chested” appearance), weight loss with disease progression, severe exertional dyspnea with a mild nonproductive cough, lack of cyanosis, and pursing of the lips with efforts to forcibly exhale air from the lungs. Currently, it is recognized that most patients with COPD may exhibit features of both diseases (Box 7.1).

LABORATORY AND DIAGNOSTIC FINDINGS

Diagnosing COPD in its early stages can be difficult, but the possibility of this clinical entity should be considered in any patient who experiences dyspnea with previously tolerated activities and demonstrates chronic cough with or without sputum production, as well as

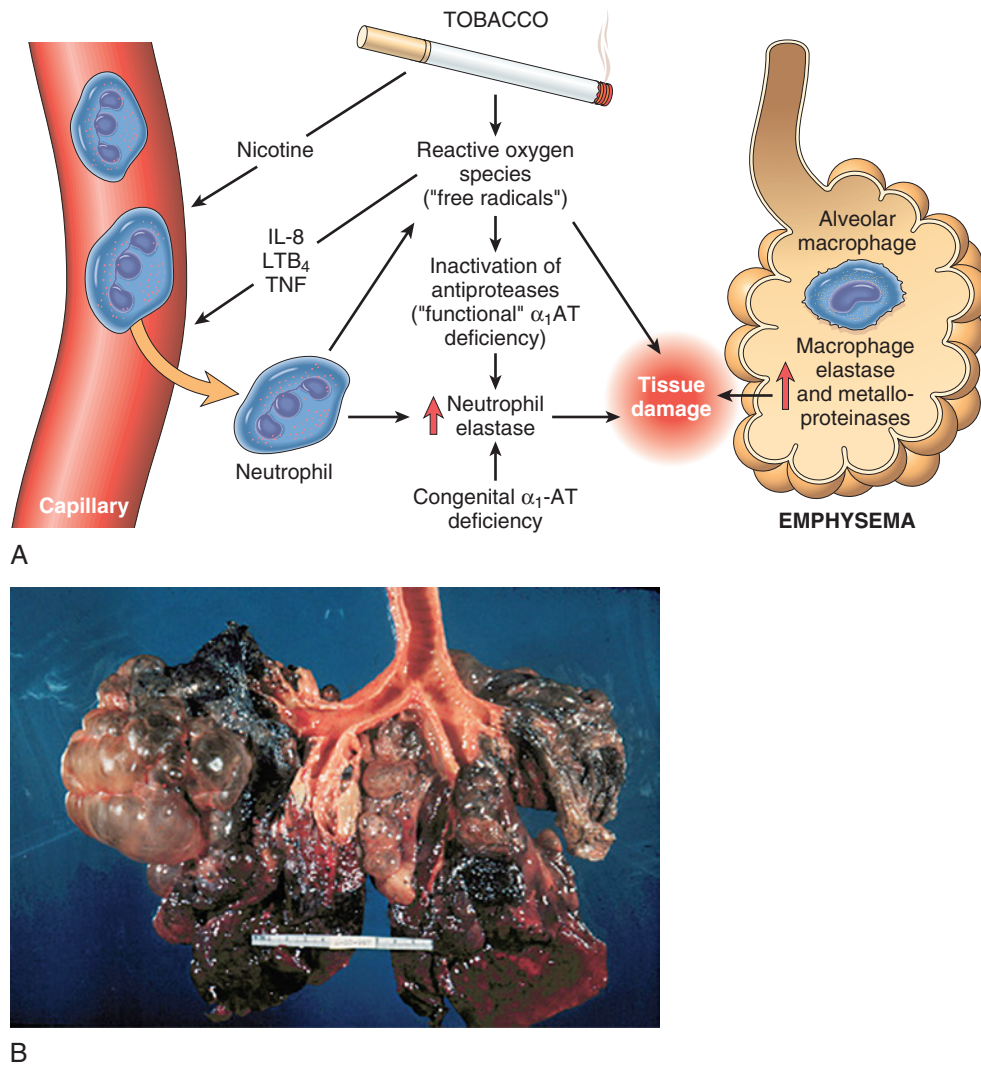

FIG 7.2 A, Pathogenesis of emphysema involving imbalance in proteases and antiproteases that results in tissue damage and collapse of alveoli. **B**, Gross pathologic specimen of an emphysemic lung. α_1 -AT, antitrypsin; *IL-8*, interleukin-8; *LTB₄*, leukotriene B₄; *TNF*, tumor necrosis factor. (A, From Kumar V, Abbas A, Fausto N, editors: *Robbins & Cotran pathologic basis of disease*, ed 8, Philadelphia, 2010, Saunders. B, Courtesy of McLay RN, et al: *Tulane gross pathology tutorial*, Tulane University School of Medicine, New Orleans, LA, 1997.)

exposure to risk factors, especially cigarette smoke. A 6-minute walk distance test can help screen for compromised respiratory function and reduced oxygen uptake; however, the key diagnostic procedures for COPD involve measures of expiratory airflow. Forced vital capacity (FVC) and forced expiratory volume in 1 second (FEV₁) are determined by spirometry, a simple objective test that measures the amount of air a person can breathe out (Fig. 7.3). A diagnosis of COPD is assigned when patients have pulmonary symptoms and FEV₁ less than 70% of predicted volume (FVC) in the absence of any other pulmonary disease. The four stages of COPD are shown in Box 7.2.

Arterial blood gas measurement and chest radiographs aid in the diagnosis. Patients with chronic bronchitis have

an elevated partial pressure of carbon dioxide (PCO₂) and decreased partial pressure of oxygen (PO₂) (as measured by arterial blood gases), leading to secondary erythrocytosis, an elevated hematocrit value, and compensated respiratory acidosis. Patients with emphysema have a relatively normal PCO₂ and a decreased PO₂, which maintain normal hemoglobin saturation, thus avoiding erythrocytosis. Total lung capacity and residual volume are markedly increased. The ventilatory drive of hypoxia also is reduced in both types of COPD.

Chest radiographs and computed tomography scans assist in classifying COPD and identifying comorbid conditions. In chronic bronchitis, typical radiographic abnormalities consist of increased bronchovascular markings at the base of the lungs (Fig. 7.4). In emphysema,

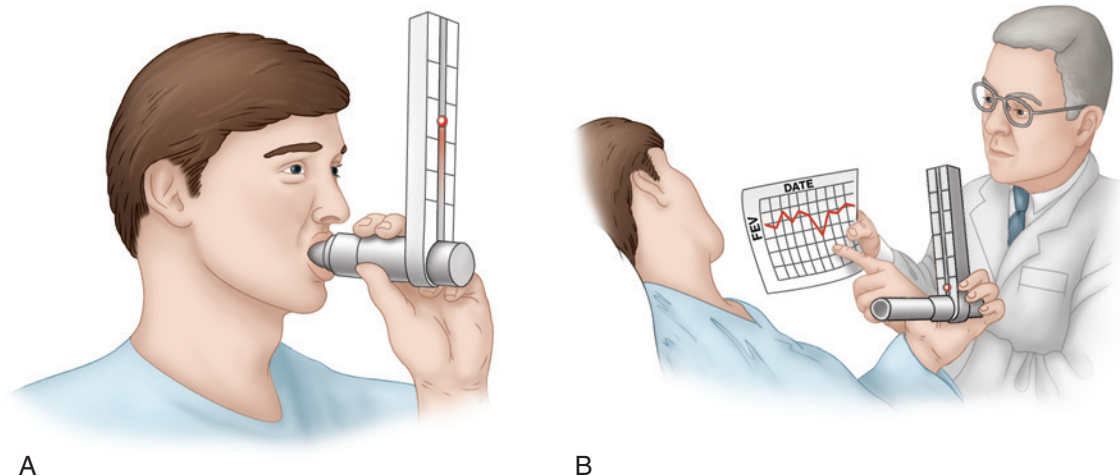

FIG 7.3 **A**, Measure of forced expiratory volume by spirometry. **B**, Discussion of daily spirometry results with the physician.

BOX 7.2 Stages of Chronic Obstructive Pulmonary Disease

Stage I—mild COPD: defined by an FEV_1/FVC ratio of $<70\%$ and an FEV_1 of $\geq 80\%$ of that predicted and sometimes chronic cough and sputum production

Stage II—moderate COPD: worsening airflow limitation and $FEV_1/FVC < 70\%$ and FEV_1 of 50% to $<80\%$ predicted, with shortness of breath typically developing on exertion

Stage III—severe COPD: $FEV_1/FVC < 70\%$ and FEV_1 of 30% to $<50\%$ predicted, with further worsening of airflow limitation and exacerbations that impact a patient's quality of life

Stage IV—very severe COPD: $FEV_1/FVC < 70\%$; $FEV_1 < 30\%$ predicted, with chronic respiratory failure and exacerbations that may be life threatening

COPD, Chronic obstructive pulmonary disease; *FEV1*, forced expiratory volume in 1 second; *FVC*, forced vital capacity.

radiographic images demonstrate persistent and marked overdistention of the lungs, flattening of the diaphragm, and emphysematous bullae.

MEDICAL MANAGEMENT

Although COPD is an irreversible process for which no cure exists, treatment can control symptoms and slow disease progression. Management strategies include smoking cessation, avoidance of pulmonary irritants, influenza and pneumococcal vaccinations, and use of short- and long-acting bronchodilators. Other recommended measures include improving exercise tolerance, good nutrition, and adequate hydration. Of note, smoking cessation is the most effective and cost-effective intervention that can reduce risk of COPD and its progression.

Inhaled bronchodilators serve as the cornerstone of pharmacologic management and are recommended in a stepwise manner, as shown in [Fig. 7.5](#).^{1,2} The primary

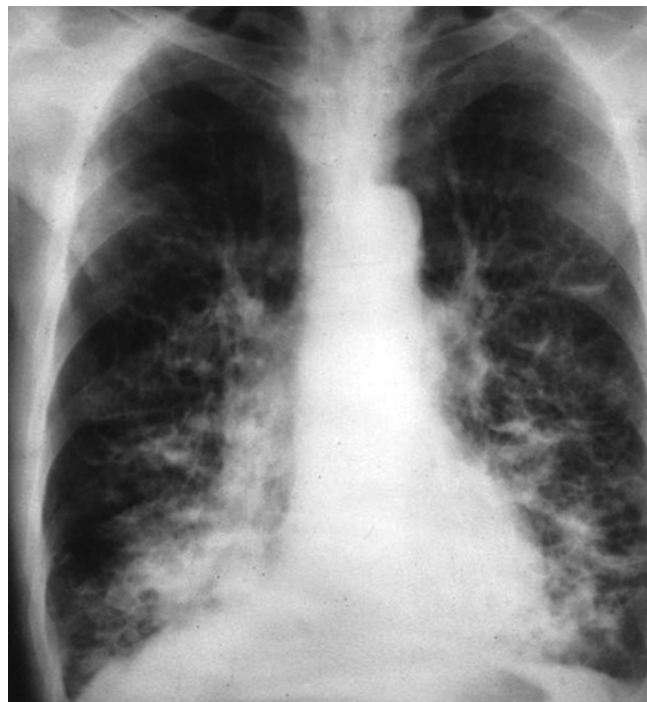

FIG 7.4 Chest radiograph of a patient with chronic obstructive pulmonary disease showing prominent vascular markings (consistent with chronic bronchitis).

inhaled agents are short- and long-acting anticholinergics (e.g., ipratropium, tiotropium) that reduce glandular mucus and relax smooth muscle by blocking acetylcholine at the muscarinic receptors and short- and long-acting β_2 -adrenergic bronchodilators that relax smooth muscle by increasing cyclic adenosine monophosphate levels. Combining bronchodilators can lead to pronounced benefits, because they work by different mechanisms ([Table 7.1](#)). Inhaled corticosteroids are added to the regimen for symptomatic patients at stage III or above who have

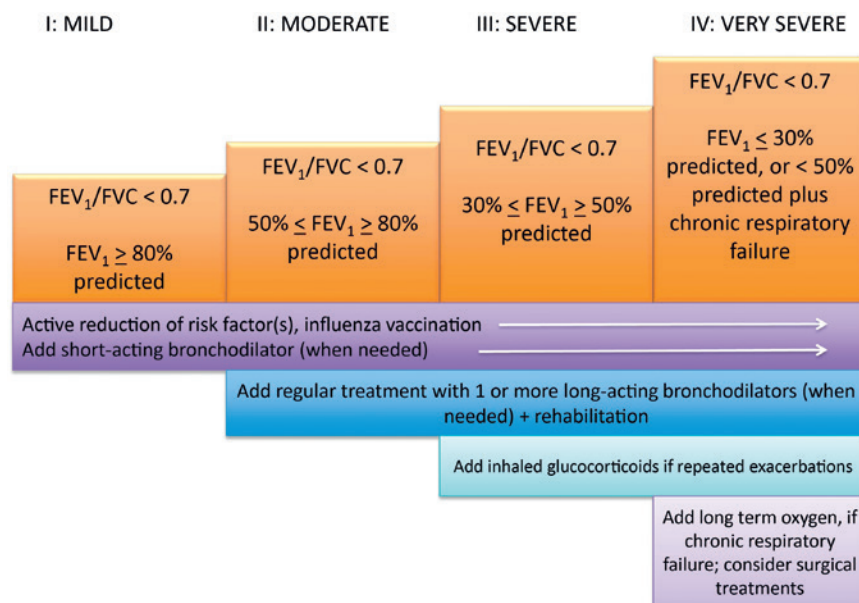

FIG 7.5 Clinical algorithm for treatment of chronic obstructive lung disease. (Redrawn from Global Initiative for Chronic Obstructive Lung Disease: *Pocket Guide to COPD diagnosis, management and prevention, a guide for health care professionals*, 2010. http://fitsweb.uchc.edu/student/selectives/jkoliani/GOLD_Pocket_2010Mar31.pdf)

repeated exacerbations. Phosphodiesterase inhibitors are alternative agents used. Theophylline, a methylxanthine nonselective phosphodiesterase inhibitor, relaxes bronchial smooth muscle cells but has a limited role in COPD management because of its narrow therapeutic range and likelihood of adverse effects (especially in older adults).^{13,14} When used, theophylline is administered as a slow-release formulation. More recently, phosphodiesterase-4-selective inhibitors (e.g., roflumilast, cilomilast) are being used to reduce exacerbations in patients with more advanced COPD.

Antibiotics are used for pulmonary infections, and low-flow supplemental O₂ (2 L/min) is recommended when the patient's PO₂ is 88% or less.^{1,15} Other important treatment options include pulmonary rehabilitation, screening for comorbid conditions, and continual monitoring for disease progression.

DENTAL MANAGEMENT

Prevention of Potential Problems

Identification. Most patients with COPD have a history of smoking tobacco and may present with a cough, exertional dyspnea, or a change in skin color. Recognition of these features should stimulate the dentist to refer these patients to a physician for care. Also, prevention of disease progression can be influenced by dental health care providers who encourage smokers to quit. By providing information on the diseases associated with smoking and its effect on healthy living, dental health providers can help patients to start thinking seriously about giving up the habit. Many interventional approaches (e.g.,

nicotine replacement, bupropion therapy) are available, and providers should help patients implement the method with which they feel most comfortable (see Chapter 8).^{16,17}

Risk Assessment. Before initiating dental care, clinicians should assess the severity of the patient's respiratory disease and the degree to which it is controlled. A patient coming to the office for routine dental care who displays shortness of breath at rest, a productive cough, upper respiratory infection (URI), or an oxygen saturation (O₂ sat) level less than 91% (as determined by pulse oximetry) is unstable.

Recommendations

Airway and Breathing. If the patient is stable (O₂ sat >95%) and breathing is adequate (no dyspnea), efforts should be directed toward the avoidance of anything that could further depress respiration (Box 7.3). Pulse oximetry monitoring is advised. Humidified low-flow O₂—generally at a rate of 2 to 3 L/min—may be provided and should be considered for use when the oxygen saturation level is less than 95%. If the O₂ sat is less than 91% or there is dyspnea or an URI present, then the patient is considered unstable, and the appointment should be rescheduled and an appropriate medical referral made.

Capacity to Tolerate Care. Dental care can be provided to patients with stages I to III COPD but should be avoided in patients who have stage IV (very severe) COPD. Of note, patients with COPD often have coexisting hypertension and coronary heart disease, a shortened life span, and a higher risk of heart failure, arrhythmia, and MI.¹¹ If coexisting cardiovascular disease is present, stress reduction measures should be implemented, and vital sign

TABLE 7.1 Drugs Used in Outpatient Management of Chronic Obstructive Pulmonary Disease (COPD) and Asthma

Drug	Trade Name	Dental Considerations
ANTIINFLAMMATORY DRUGS		
Corticosteroids—Inhaled		
Beclomethasone dipropionate	Vanceril, Beclovent	Not intended for acute asthma attacks; may contribute to the development of oral candidiasis if used improperly or excessively
Budesonide	Pulmicort	
Ciclesonide		
Dexamethasone	Decadron	
Flunisolide	AeroBid	
Fluticasone propionate	Flonase	
Mometasone		
Triamcinolone acetonide	Azmacort	
Corticosteroids Combination With Long-Acting β_2-Selective Agonist Inhalers		
Formoterol–budesonide	Symbicort	Not intended for acute asthma attacks; may contribute to the development of oral candidiasis if used improperly or excessively
Salmeterol–fluticasone	Advair HFA inhaler	
Formoterol–mometasone	Dulera	
Corticosteroids—Systemic		
Prednisone	Deltasone or generic	Not intended for acute asthma attacks; possible adrenal suppression, cushingoid features, and osteoporosis with long-term use
Prednisolone	Delta-Cortef	
Methylprednisolone	Solu-Medrol	
Antileukotrienes		
5-Lipoxygenase inhibitor Zileuton	Zyflo	Not intended for acute asthma attacks
Leukotriene Receptor Antagonists		
Montelukast	Singulair	
Zafirlukast	Accolate	
Nonsteroidal—Chromones		
Cromolyn sodium	Intal inhaler	Not intended for acute asthma attacks
Nedocromil	Tilade inhaler	
β-ADRENERGIC BRONCHODILATORS		
Fast-Acting Nonselective β-Agonist Inhalers		
Epinephrine*	Primatene Mist, Bronkaid (available in parenteral form also)	For use during acute asthma attacks
Ephedrine†	Eted II	
Intermediate-Acting Nonselective β-Agonist Inhalers (3–6 hours)		
Isoproterenol‡	Isuprel	Not best choice for use during acute asthma attacks
Isoetharine	Bronkosol	
Metaproterenol§	Alupent, Metaprel, others	
β_2-Selective Agonist Inhalers (4–6 hours)		
Albuterol‡	Proventil, Ventolin	For use during acute asthma attacks
Bitolterol mesylate	Tornalate	
Fenoterol	Berotec	
Levalbuterol	Xopenex	
Pirbuterol	Maxair, Maxair Autohaler	
Terbutaline‡	Brethaire, Bricanyl	

TABLE 7.1 Drugs Used in Outpatient Management of Chronic Obstructive Pulmonary Disease (COPD) and Asthma—cont'd

Drug	Trade Name	Dental Considerations
Long-Acting β_2-Selective Agonist Inhalers (>12 hours)		
Indacaterol	Arcapta Neohaler	For COPD; not indicated for asthma
Salmeterol (slow onset, long duration)	Serevent	Not intended for acute asthma attacks
Formoterol (rapid onset, long duration)	Foradil	
Combination β_2-Selective Agonist Inhalers Plus Anticholinergic in One Inhaler		
Fenoterol–ipratropium	Duovent	Paradoxical bronchospasm, dry mouth, throat irritation
Albuterol (Salbutamol)–ipratropium	Combivent	Headache, dizziness, dry mouth
ANTICHOLINERGIC BRONCHODILATORS (QUATERNARY AMMONIUM DERIVATIVES OF ATROPINE)		
Aclidinium bromide	Tudorza Pressair	Not intended for acute asthma attacks; generally used in combination with other antiasthma drugs or for COPD; can cause headache
Ipratropium bromide	Atrovent	
Tiotropium (long acting)	Spiriva	
PHOSPHODIESTERASE (PD) INHIBITORS		
Theophylline (nonselective)	Theo-Dur	Adverse drug interaction with erythromycin and azithromycin; serum drug levels should be monitored for toxicity
Roflumilast (selective PD-4)	Daxas, Daliresp	Adverse effects of headache, coughing may affect diagnostic workup and treatment
Cilomilast (selective PD-4)	Ariflo	
Anti-IgE		
Omalizumab	Xolair	Dizziness, muscle aches

Injectable α_1 -proteinase inhibitor formulations (Aralast, Prolastin, Zemaira) are available for treatment of emphysema caused by inherited α_1 -antitrypsin deficiency.

*Inhalation and parenteral.

[†]Oral and parenteral.

[‡]Inhalation, oral, and parenteral.

[§]Inhalation and oral. Some combination drugs are formoterol + budesonide propionate (Symbicort) and salmeterol + fluticasone propionate (Advair).

COPD, Chronic obstructive pulmonary disease.

monitoring is advised (see [Chapters 3 and 4](#)). Supplemental oxygen should be provided as described earlier.

Chair Position. Patients who have moderate to severe disease should be placed in a semisupine or upright chair position for treatment, rather than in the supine position. The more upright chair position helps to prevent orthopnea and a feeling of respiratory discomfort.

Drug Considerations. No contraindication to the use of local anesthetic has been identified. However, the use of bilateral mandibular blocks or bilateral palatal blocks can cause an unpleasant airway constriction sensation in some patients. This concern may be more important in the management of a patient with severe COPD with a rubber dam or when medications are administered that dry mucous secretions. Humidified low-flow O_2 can be provided to alleviate the unpleasant airway feeling produced by nerve blocks, use of a rubber dam, and/or medications.

If sedative medication is required, low-dose oral diazepam (Valium) may be used. Nitrous oxide–oxygen inhalation sedation should be used with caution in patients with mild to moderate chronic bronchitis. It should not

be used in patients with stage III or IV COPD because the nitrous oxide may accumulate in air spaces of the diseased lung. If this sedation modality is used in a patient with chronic bronchitis, flow rates should be reduced to no greater than 3 L/min, and the clinician should anticipate induction and recovery times with nitrous oxide approximately twice as long as those in healthy patients.¹⁸ Narcotics and barbiturates should not be used because of their respiratory depressant properties. Anticholinergics and antihistamines generally should be used with caution in patients with COPD because of their drying properties and the resultant increase in mucus tenacity; because patients with chronic bronchitis may already be taking these types of medications, concurrent administration could result in additive effects.

Patients taking systemic corticosteroids may require supplementation for major surgical procedures because of adrenal suppression (see [Chapter 15](#)). Macrolide antibiotics (e.g., erythromycin, azithromycin) and ciprofloxacin hydrochloride should be avoided in patients taking theophylline because these antibiotics can reduce the metabolism of theophylline, resulting in theophylline

BOX 7.3 Dental Management: Considerations in Patients With Chronic Obstructive Pulmonary Disease (COPD)
P**Patient Evaluation and Risk Assessment (see Box 1.1)**

- Evaluate and determine whether COPD is present.
- Obtain medical consultation if the condition is poorly controlled (as manifested by dyspnea, coughing, or frequent upper respiratory infections) or undiagnosed or if the diagnosis is uncertain. Review history and clinical findings for concurrent heart disease.
- Encourage current smokers to stop smoking.

Potential Issues and Factors of Concern**A**

Analgesics	No issues
Antibiotics	Avoid erythromycin, macrolide antibiotics, and ciprofloxacin in patients taking theophylline. In patients who have received courses of antibiotics for upper respiratory infections, oral and lung flora may include antibiotic-resistant bacteria.
Anesthesia	Local anesthesia can be used without change in technique. Avoid outpatient general anesthesia.
Anxiety	Avoid nitrous oxide–oxygen inhalation sedation in patients with severe (stage 3 or worse) COPD. Consider low-dose oral diazepam or another benzodiazepine, although these agents may cause oral dryness.

B

Bleeding	No issues
Blood pressure	Patients with COPD can have cardiovascular comorbidity. Assess blood pressure.

C

Chair position	Semisupine or upright chair position may be better for treatment in these patients.
----------------	---

D

Devices	Avoid use of rubber dam in patients with severe disease. Use pulse oximetry to monitor oxygen saturation. Spirometry readings are helpful in determining level of control.
Drugs	Avoid use of barbiturates and narcotics, which can depress respiration. Avoid use of antihistamines and anticholinergic drugs because they can further dry mucosal secretions. Supplemental steroids are unlikely to be needed to perform routine dental care; the usual morning corticosteroid dose should be taken on the day of surgical procedures.

E

Equipment	Monitor oxygen saturation with pulse oximeter during sedation and invasive procedures. Use low-flow (2–3 L/min) supplemental O ₂ when oxygen saturation drops below 95%; it may become necessary when oxygen saturation drops below 91%.
Emergencies	No issues

F

Follow-up	At each follow-up appointment, encourage the patient to quit smoking and examine the oral cavity for lesions that may be related to smoking. Avoid treatment if upper respiratory infection is present.
-----------	---

toxicity.¹⁹ The dentist should be aware of the manifestations of theophylline toxicity. Signs and symptoms include anorexia, nausea, nervousness, insomnia, agitation, thirst, vomiting, headache, cardiac arrhythmias, and convulsions. Outpatient general anesthesia is contraindicated for most patients with COPD.

Oral Complications and Manifestations

Patients with COPD who are chronic smokers have an increased likelihood of developing halitosis, extrinsic tooth stains, nicotine stomatitis, periodontal disease, premalignant mucosal lesions, and oral cancer.²⁰ Poor oral hygiene, oral bacteria, and periodontitis can contribute to acute respiratory exacerbations and aspiration pneumonia in frail older adults who have COPD.^{21,22} Anticholinergics are associated with dry mouth. In rare instances, theophylline has been associated with the development of Stevens-Johnson syndrome.²³

ASTHMA

Asthma is a chronic inflammatory disease of the airways characterized by reversible episodes of increased airway hyperresponsiveness, which results in recurrent episodes of dyspnea, coughing, and wheezing. The bronchiolar lung tissue of patients with asthma is particularly sensitive to a variety of stimuli. Overt attacks (flare-ups) may be provoked by allergens, URI, exercise, cold air, certain medications (salicylates, nonsteroidal antiinflammatory drugs (NSAIDs), cholinergic drugs, and β -adrenergic blocking drugs), chemicals, smoke, and highly emotional states such as anxiety and stress.

EPIDEMIOLOGY

Asthma affects 300 million persons worldwide and accounts for 1 of every 250 deaths worldwide.²⁴ In the

United States, its prevalence has more than doubled since the 1960s, from about 2% to 8% (affecting 25 million people).^{25,26} Asthma is a disease primarily of children, with 10% of children (6.6 million) affected.^{25,27} Females have higher rates of asthma than males, although the prevalence is higher during childhood in boys. Higher body mass index (BMI) increases the risk for asthma in women.²⁸ The disease has a higher prevalence in families whose income is below the poverty level and affects 6% of older adults.^{25,29} It occurs in all races, with a higher prevalence among African Americans and multirace individuals than among whites and Asians.³⁰ Patients with asthma in the United States make more than 2 million visits to emergency departments (EDs) annually, and more than 3500 asthma-related deaths occur annually.³¹ On the basis of current figures, the average dental practice is estimated to include at least 100 patients who have asthma.

ETIOLOGY

Asthma is a multifactorial and heterogeneous disease whose exact cause is not completely understood. Its development requires interaction between the environment and genetic susceptibility, with clinical manifestations resulting from dysfunction of the airway epithelium, smooth muscle, immune cells, and neuronal elements.³² Many triggers of asthma are recognized; these factors traditionally have been grouped into one of four categories based on pathophysiology: extrinsic (allergic or atopic), intrinsic (idiosyncratic, nonallergic, or nonatopic), drug induced, and exercise induced. Today, from a management perspective, the type of trigger is more important than the category.

Allergic or extrinsic asthma is the most common form and accounts for approximately 35% of all adult cases. It is an exaggerated inflammatory response that is triggered by inhaled seasonal allergens such as pollens, dust, house mites, and animal danders. Allergic asthma usually is seen in children and young adults. In these patients, a dose–response relationship exists between allergen exposure and immunoglobulin E (IgE)–mediated sensitization, positive skin testing to various allergens, and associated family history of allergic disease. Inflammatory responses are mediated primarily by type 2 helper T (T_H2) cells, which secrete interleukins and stimulate B cells to produce IgE (Fig. 7.6). During an attack, allergens interact with IgE antibodies affixed to mast cells, basophils, and eosinophils along the tracheobronchial tree. The complex of antigen with antibody causes leukocytes to degranulate and secrete vasoactive autotoxins and cytokines such as bradykinins, histamine, leukotrienes, and prostaglandins.³³ Histamine and leukotrienes cause smooth muscle contraction (bronchoconstriction) and increased vascular permeability, and they attract eosinophils into the airway.³⁴ The release of platelet-activating factor sustains bronchial hyperresponsiveness. Release

of E-selectin and endothelial cell adhesion molecules, neutrophil chemotactic factor, and eosinophilic chemotactic factor of anaphylaxis is responsible for recruitment of leukocytes (neutrophils and eosinophils) to the airway wall, which increases tissue edema and mucus secretion. T lymphocytes prolong the inflammatory response (late-phase response), and imbalances in matrix metalloproteinases and tissue inhibitor metalloproteinases may contribute to fibrotic changes.

Intrinsic asthma accounts for about 30% of asthma cases and seldom is associated with a family history of allergy or with a known cause. Patients usually are nonresponsive to skin testing and demonstrate normal IgE levels. This form of asthma generally is seen in middle-aged adults, and its onset is associated with endogenous factors such as emotional stress (implicated in at least 50% of affected persons), gastroesophageal acid reflux, or vagally mediated responses.³⁴

Ingestion of certain drugs (e.g., aspirin, NSAIDs, beta-blockers, angiotensin-converting [ACE] enzyme inhibitors) and some food substances (e.g., nuts, shellfish, strawberries, milk, tartrazine food dye yellow color no. 5) can trigger asthma.³⁵ Aspirin causes bronchoconstriction in about 10% of patients with asthma, and sensitivity to aspirin occurs in 30% to 40% of people with asthma who have pansinusitis and nasal polyps (the so-called “triad asthmaticus”).^{35,36} The ability of aspirin to block the cyclooxygenase pathway appears causative. The buildup of arachidonic acid and leukotrienes mediated by the lipoxygenase pathway results in bronchial spasm.^{35,36}

Metabisulfite preservatives of foods and drugs (specifically in local anesthetics containing epinephrine) may cause wheezing when metabolic levels of the enzyme sulfite oxidase are low.³⁷ Sulfur dioxide is produced in the absence of sulfite oxidase. The buildup of sulfur dioxide in the bronchial tree precipitates an acute asthma attack.³⁵

Exercise-induced asthma is stimulated by exertional activity. Although the pathogenesis of this form of asthma is unknown, thermal changes during inhalation of cold air provoke mucosal irritation and airway hyperactivity. Children and young adults are more severely affected because of their high level of physical activity.

Infectious asthma is a term previously used to describe persons who developed asthma because of the inflammatory response to bronchial infection. Now it is recognized that several respiratory viral infections during infancy and childhood can result in the development of asthma. Also, causative agents of respiratory infections (bacteria, dermatologic fungi *Trichophyton* spp., and *Mycoplasma* organisms) can exacerbate asthma. Treatment of the respiratory infection generally improves control of bronchospasm and constriction.

PATHOPHYSIOLOGY AND COMPLICATIONS

In asthma, obstruction of airflow occurs as the result of bronchial smooth muscle spasm, inflammation of bronchial

A Sensitization to allergen

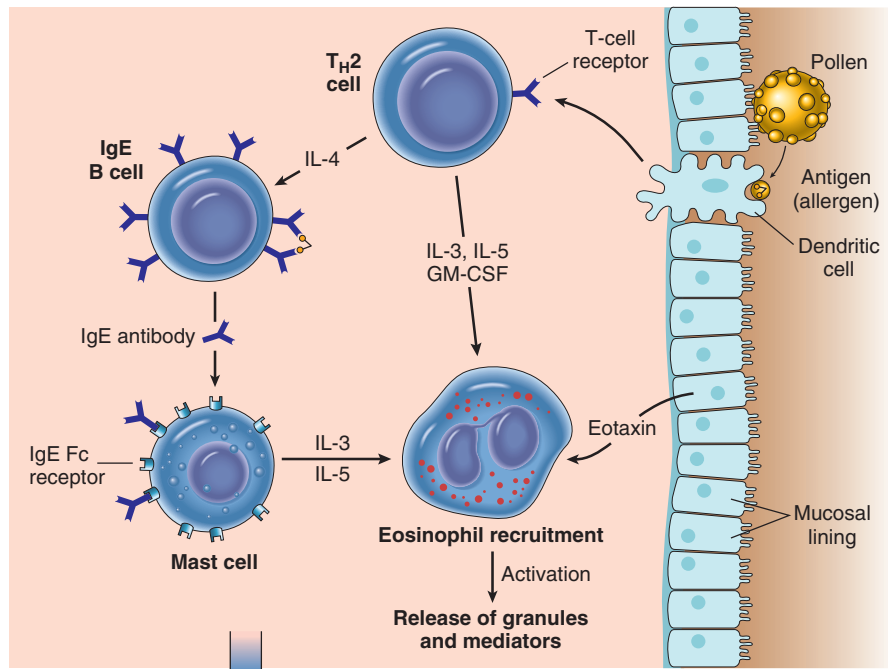
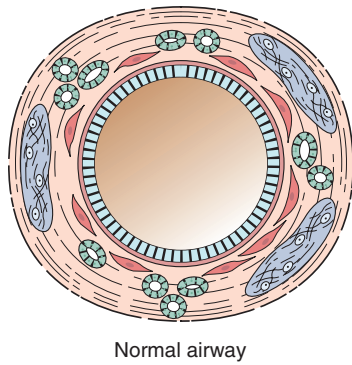

B Allergen-triggered asthma

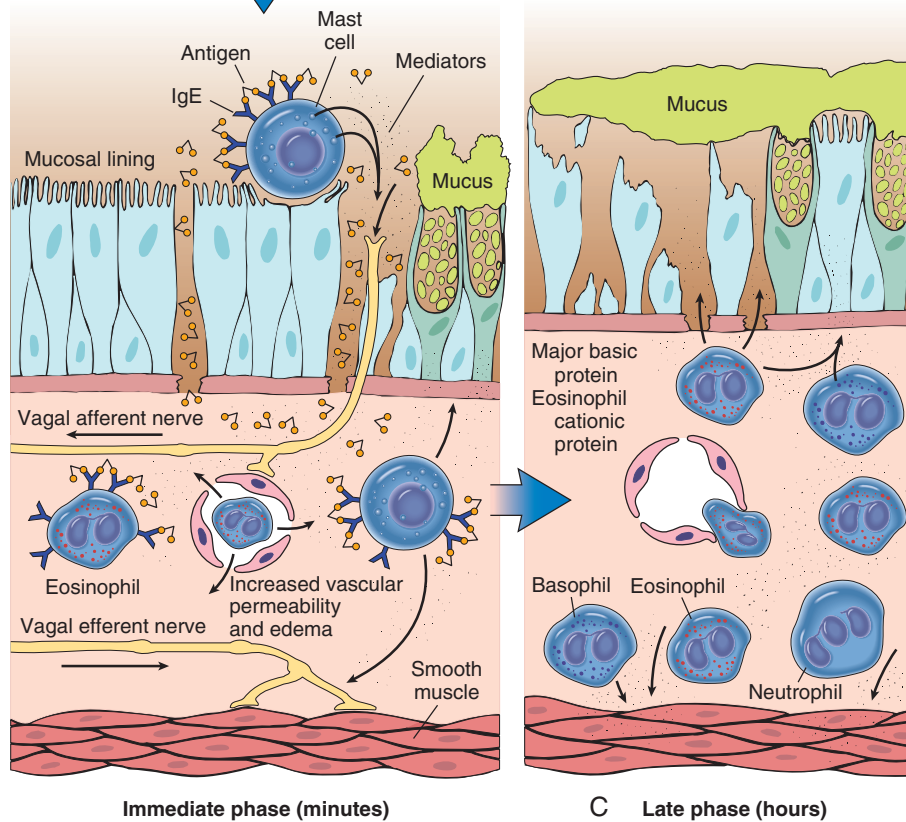
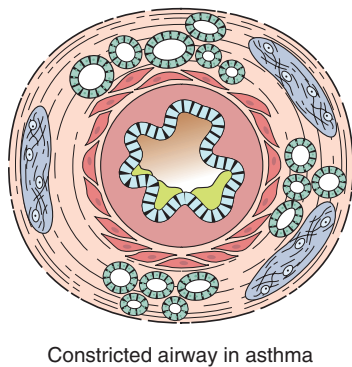

FIG 7.6 Processes involved in allergic (extrinsic) asthma. *GM-CSF*, Granulocyte-macrophage colony-stimulating factor; *IL*, interleukin. (From Kumar V, Abbas A, Fausto N, editors: *Robbins & Cotran pathologic basis of disease*, ed 8, Philadelphia, 2010, Saunders.)

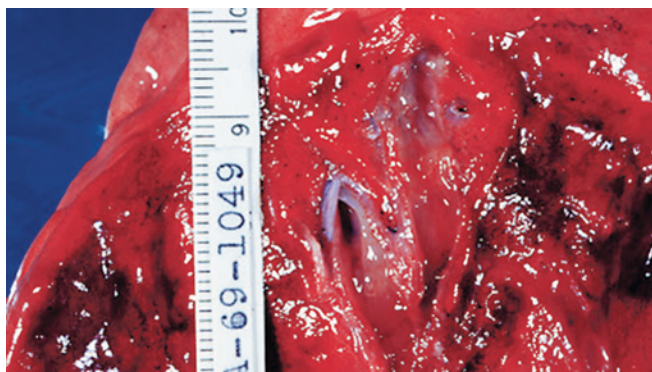

FIG 7.7 Section of a lung with the bronchioles occluded by mucous plugs. (Courtesy McLay RN, et al: *Tulane gross pathology tutorial*, Tulane University School of Medicine, New Orleans, LA, 1997.)

mucosa, mucus hypersecretion, and sputum plugging. The most striking macroscopic finding in the asthmatic lung is occlusion of the bronchi and bronchioles by thick, tenacious mucous plugs (Fig. 7.7). Histologic findings are those of inflammation and airway remodeling, including (1) thickening of the basement membrane (from collagen deposition) of the bronchial epithelium, (2) edema, (3) mucous gland hypertrophy and goblet cell hyperplasia, (4) hypertrophy of the bronchial wall muscle, (5) accumulation of mast cell and inflammatory cell infiltrate, (6) epithelial cell damage and detachment, and (7) blood vessel proliferation and dilation.²⁴ These changes contribute to decreased diameter of the airway, increased airway resistance, and difficulty in expiration.

Asthma is relatively benign in terms of morbidity. Most patients can expect a reasonably good prognosis, especially those in whom the disease develops during childhood. In many young children, the condition resolves spontaneously after puberty. In one reported series, however, two thirds of children with asthma still had symptoms at age 21 years.²⁴ In a small percentage of patients, both young and old, the condition can progress to COPD, and respiratory failure, or status asthmaticus, the most serious manifestation of asthma, may occur.

Status asthmaticus is a particularly severe and prolonged asthmatic attack (one lasting longer than 24 hours) that is refractory to usual therapy. Signs include increased and progressive dyspnea, jugular venous pulsation, cyanosis, and pulsus paradoxus (a fall in systolic pressure with inspiration). Status asthmaticus often is associated with a respiratory infection and can lead to exhaustion, severe dehydration, peripheral vascular collapse, and death. Although death directly attributable to asthma is relatively uncommon, the disease causes about 3500 deaths per year in the United States.²⁵ Asthma deaths occur more often in persons older than 45 years of age, are largely preventable, and often are related to delays in delivery of appropriate medical care.²⁴

CLINICAL PRESENTATION

Signs and Symptoms

Asthma is a disease of episodic attacks of airway hyperresponsiveness. For reasons that are unclear, flare-ups often occur at night or on waking, but they also may follow or accompany exposure to an allergen, exercise, respiratory infection, or emotional upset and excitement. Typical symptoms and signs of asthma consist of wheezing, reversible episodes of breathlessness (dyspnea), cough, chest tightness, and flushing. The onset usually is sudden, with peak symptoms occurring within 10 to 15 minutes. Inadequate treatment results in ED visits for about 25% of patients.²⁹ Respirations become difficult and are accompanied by expiratory wheezing. Tachypnea and prolonged expiration are characteristic. Termination of an attack commonly is accompanied by a productive cough with thick, stringy mucus. Episodes usually are self-limiting, although severe attacks may necessitate medical assistance.

LABORATORY AND DIAGNOSTIC FINDINGS

Diagnostic testing by a physician is important in the differentiation of asthma from other airway diseases. Experienced clinical judgment and recognition of the signs and symptoms are essential because laboratory tests for asthma are relatively nonspecific, and no single test is diagnostic. Commonly ordered tests include 6-minute walk test, spirometry before and after administration of a short-acting bronchodilator, chest radiographs (to detect hyperinflation), skin testing (for specific allergens), bronchial provocation (by histamine or methacholine chloride challenge) testing, sputum smear examination and cell counts (to detect neutrophilia or eosinophilia), arterial blood gas determination, and antibody-based enzyme-linked immunosorbent assay (ELISA) for measurement of environmental allergen exposure.³⁸ Spirometry is widely applied in diagnosing asthma because by definition, the associated airflow obstruction must be episodic and at least partially reversible. Reversibility is demonstrated by an increase in pulmonary function (i.e., FEV₁) of 12% or greater from baseline after therapy or after inhalation of a short-acting bronchodilator. Also, a recent drop in FEV₁ can be interpreted as a predictive of an asthma attack (see Fig. 7.3), and a drop of more than 10% during exercise fulfills the diagnosis of exercise-induced asthma. Fractional exhaled nitric oxide determination is an additional noninvasive test used to aid in the diagnosis and management of asthma.³⁹

Classification

Patients with chronic asthma are clinically classified as having intermittent or persistent disease (mild, moderate, or severe asthma).⁴⁰ Severity is based on age, frequency of symptoms, impairment of lung function, and risk of attacks (Box 7.4). Persons older than 12 years of age are

BOX 7.4 Classification of Asthma and Recommended Drug Management (12 Years and Older)

Intermittent

Symptoms ≤ 2 per week; brief exacerbations; asymptomatic between exacerbations; nocturnal symptoms < 2 per month; FEV ₁ $> 80\%$ of predicted; FEV ₁ /FVC ratio $> 85\%$ (normal)	Short-acting β_2 -agonist as needed
--	---

Mild Persistent

Symptoms > 2 per week but not daily; nocturnal symptoms 3–4 per month (limited exercise tolerance; rare ED visits); FEV ₁ $> 80\%$ of predicted; FEV ₁ /FVC $> 85\%$ (normal 8–19 years), 80% (20–39 years), 75% (40–59 years), 70% (60–80 years)	Low-dose inhaled corticosteroids or other antiinflammatory drug as needed; short-acting β_2 -agonist as needed
---	--

Moderate Persistent

Daily symptoms; daily use of inhaled short-acting β -agonist; exacerbations that may affect activity and sleep; nocturnal symptoms > 1 time per week but not nightly (occasional ED visits); FEV ₁ 60%–80% of predicted; FEV ₁ /FVC reduced 5%	Low- or medium-dose inhaled corticosteroids + long-acting bronchodilator as needed; short-acting β_2 -agonist as needed
--	---

Severe Persistent

Symptoms throughout the day; frequent (often 7 times a week) exacerbations and nocturnal asthma symptoms; exercise intolerance; FEV ₁ $< 60\%$; FEV ₁ /FVC reduced $> 5\%$ (often resulting in hospitalization)	High-dose inhaled corticosteroids + long-acting bronchodilator or montelukast + oral corticosteroid as needed; short-acting β_2 -agonist as needed
--	--

*There are differences in the criteria based on ages 0 to 4 years, 5 to 11 years, and older than 12 years.

ED, Emergency department; FEV₁, forced expiratory volume in 1 second; FVC, forced vital capacity.

Adapted from National Heart, Lung, and Blood Institute: *Asthma care quick reference: diagnosing and managing asthma*. <http://www.nhlbi.nih.gov/health-pro/guidelines/current/asthma-guidelines/quick-reference.html>.

classified as mild persistent asthma when they have symptoms more than twice per week but not daily and an FEV₁ greater than 85%. Symptoms generally last less than 1 hour. Patients with moderate asthma have FEV₁ greater than 60% but less than 80% and daily symptoms that affect sleep and activity level and, on occasion, require occasional emergency care. Asthma is classified as severe when patients have less than 60% FEV₁, which results

in symptoms throughout the day that limit normal activity. Attacks are frequent or continuous, occur at night, and result in emergency hospitalization.

MEDICAL MANAGEMENT

The goals of asthma therapy are to limit exposure to triggering agents, allow normal activities, restore and maintain normal pulmonary function, minimize the frequency and severity of attacks, control symptoms, and avoid adverse effects of medications.⁴⁰ Experts agree that these goals are best accomplished by educating patients and involving them in the prevention or elimination of precipitating factors (e.g., smoking cessation) and comorbid conditions (rhinosinusitis, obesity) that confound management, establishment of a plan for regular self-monitoring, and provision of regular follow-up care.⁴⁰ Specifically, it is recommended that a written education and action plan be given to each patient, with appropriate support and instructions for its use. Inexpensive peak expiratory flow meters should be used regularly at home and levels recorded daily in diaries. For patients with known allergies, the importance of avoidance of allergens to prevent attacks should be underscored. This can be conveyed by monitoring of allergen levels (tobacco smoke and pollutants) in the patient's home, provision of desensitization intradermal injections, and monitoring of the pulmonary function zone on the basis of daily peak flow meter results (spirometry). Unfortunately, poor control of asthma often is related to low socioeconomic status (e.g., the patient cannot afford medication), increased anxiety, poor compliance, and unfavorable home environment.

Antiasthmatic drug selection is based on the type and severity of asthma and whether the drug is to be used for long-term control or quick relief. Current guidelines recommend a "stepwise" approach with the use of inhaled antiinflammatory agents as first-line drugs (the preferred inhalational agent is a corticosteroid preparation, with a leukotriene inhibitor as an alternative) for the long-term management and prophylaxis of persistent asthma (Fig. 7.8). β -adrenergic agonists are recommended for intermittent asthma and are secondary agents that should be added (i.e., not to be used alone) for persistent asthma when antiinflammatory drugs are inadequate alone. Alternative drugs include mast cell stabilizers (cromolyn and nedocromil), immunomodulators, anticholinergics (tiotropium), and theophylline. Combination therapy with these medications often is used to improve lung function.⁴⁰

Inhaled corticosteroids are the most effective antiinflammatory medications currently available for the treatment of persistent asthma.^{41,42} They act by reducing the inflammatory response and preventing the formation of cytokines, adhesion molecules, and inflammatory enzymes. Aerosol dosage is two (for mild to moderate disease) to four times daily (severe asthma). Onset of action usually is after 2 hours, and peak effects occur 6 hours later. Long-term



FIG 7.8 Use of an inhaler by a patient.

use of steroid inhalers rarely is associated with systemic adverse effects, provided the maximum recommended dose of 1.5 mg/day of inhaled beclomethasone dipropionate (Vanceril) or equivalent is not exceeded. Use of systemic steroids is reserved for asthma unresponsive to inhaled corticosteroids and bronchodilators and for use during the recovery phase of a severe acute attack. Inhaled steroids often are used in combination with long-acting β_2 -adrenergic bronchodilators (salmeterol or formoterol); the trade names for these drugs are Advair, Symbicort, and Dulera. Agents such as omalizumab (Xolair) that block IgE (monoclonal antibody against human IgE) are used for additive therapy in patients with severe persistent asthma who have allergy triggers; however, cost and the injectable-only formulation are major considerations with this drug.⁴³

For relief of acute asthma attacks, inhaled short-acting β_2 -adrenergic agonists are the drugs of choice because of their fast and notable bronchodilatory and smooth muscle relaxation properties (see Table 7.1). Short-acting β_2 -adrenergic agonists produce bronchodilation by activating β_2 receptors on airway smooth muscle cells, generally in 5 minutes or less.³³ Inhalation corticosteroids, inhaled cromolyn sodium, and oral anticholinergics are not used for this purpose because of their slow onset of action.

β_2 -adrenergic agonists (administered by a metered-dose inhaler [MDI]) and cromolyn sodium (Intal) and

nedocromil may be used in preventing exercise-induced bronchospasm. They are taken about 30 minutes before initiation of physical activity. Cromolyn and nedocromil decrease airway hyperresponsiveness by stabilizing the membrane of mast cells and interfering with chloride channel function so that mediators are not released when challenged by exercise or cold air. Theophylline is a mild to moderate bronchodilator to be used as an alternative. Monitoring of its serum concentration is essential.

DENTAL MANAGEMENT

Identification and Prevention. The primary goal in dental management of patients with asthma is to prevent an acute asthma attack (Box 7.5). The first step in achieving this goal is to identify patients with asthma by history followed by assessment to elucidate the surrounding details of the problem, along with prevention of precipitating factors.

Risk Assessment. The dentist, through a good history, should be able to determine the severity and stability of disease. Questions should be asked that ascertain adherence to medication use (especially in the previous 4 weeks), the type of asthma (e.g., allergic versus nonallergic), precipitating substances, frequency and severity of attacks, times of day when attacks occur, whether asthma is a current or past problem, how attacks usually are managed, and whether the patient has received emergency treatment for an acute attack. The clinician must be cognizant of the variability of the disease and indications of severe disease, including frequent exacerbations, exercise intolerance, FEV₁ less than 80%, use of several medications, and a history of visits to an emergency facility or hospitalization for treatment of acute attacks (see Box 7.4).

The stability of the disease can be assessed during the interview component of the history and by clinical examination, as well as understanding the regularity of physician visits and the results of laboratory measures. Features such as symptoms 2 or more days per week, use of a short-acting β_2 -agonist more than 2 days a week, increased respiratory rate (>50% above normal), FEV₁ that has fallen more than 10% or to below 80% of peak FEV₁, an eosinophil count that is elevated to above 50/mm³, poor drug use compliance, and one or more ED visits within the previous 3 months suggest inadequate treatment and poor disease control.⁴⁴ Also, the use of more than 1.5 canisters of a β -agonist inhaler per month (>200 inhalations per month) or doubling of monthly use indicates high risk for a severe asthma attack.

For severe and unstable asthma, consultation with the patient's physician is advised. Routine dental treatment should be postponed until better control is achieved.

Recommendations

Appointment, Airway, and Breathing. Modifications during the preoperative and operative phases of dental

BOX 7.5 Dental Management: Considerations in Patients With Asthma**P****Patient Evaluation and Risk Assessment (see Box 1.1)**

- Evaluate and identify asthma as a medically confirmed or likely diagnosis along with its severity and type if present.
- Obtain medical consultation if asthma is poorly controlled (as indicated by wheezing or coughing or a recent hospitalization) or is undiagnosed or if the diagnosis is uncertain. Encourage current smokers to stop smoking.

Potential Issues and Factors of Concern**A**

Analgesics	No issues
Antibiotics	Avoid erythromycin, macrolide antibiotics, and ciprofloxacin in patients taking theophylline.
Anesthesia	Clinicians may elect to avoid solutions containing epinephrine or levonordefrin because of sulfite preservative.
Anxiety	Provide a stress-free environment through establishment of rapport and openness to reduce risk of anxiety-induced asthma attack. If sedation is required, use of nitrous oxide–oxygen inhalation sedation or small doses of oral diazepam (or both) is recommended.
Allergy	Asthmatics with nasal polyps are increased risk for allergy to aspirin. Avoid aspirin use.

B

Bleeding	No issues
Blood pressure	Monitor blood pressure during asthma attacks to observe for the development of status asthmaticus.

C

Chair position	Semisupine or upright chair position for treatment may be better tolerated.
----------------	---

D

Devices	Instruct patients to bring their current medication inhalers to every appointment; use prophylactically in moderate to severe disease. Obtain spirometry reading to determine level of control. Use pulse oximetry to monitor oxygen saturation during dental procedure.
---------	--

Drugs

Avoid precipitating odorants and drugs (aspirin). Avoid use of barbiturates and narcotics, which can depress respiration and release histamine, respectively. Supplemental steroids are unlikely to be needed in routine dental care; provide usual morning corticosteroid dose the morning of surgical procedures.

E

Equipment	Use low-flow (2–3 L/min) supplemental O ₂ when oxygen saturation drops below 95%; supplemental O ₂ also may become necessary when oxygen saturation drops below 91%.
Emergencies	Recognize the signs and symptoms of a severe or worsening asthma attack, including inability to finish sentences with one breath, ineffectiveness of bronchodilators to relieve dyspnea, recent drop in FEV ₁ as determined by spirometry, tachypnea with respiratory rate of 25 ≥ breaths/min, tachycardia with heart rate of ≥110 beats/min, diaphoresis, accessory muscle usage, and paradoxical pulse. Administer fast-acting bronchodilator (note: corticosteroids have delayed onset of action), oxygen, and, if needed, subcutaneous epinephrine (1:1000) in a dose of 0.3 to 0.5 mL. Activate EMS; repeat administration of fast-acting bronchodilator every 20 minutes until EMS personnel arrive.

F

Follow-up	Ensure that patient is receiving adequate medical follow-up care on a routine basis.
-----------	--

EMS, Emergency medical system; FEV₁, forced expiratory volume in 1 second.

management of a patient with asthma can minimize the likelihood of an attack. Patients who have nocturnal asthma should be scheduled for late-morning appointments, when attacks are less likely. Use of operatory odorants (e.g., methyl methacrylate) should be reduced before the patient is treated. Patients should be instructed to regularly use their medications, to bring their inhalers (bronchodilators) to each appointment, and to inform the dentist at the earliest sign or symptom of an asthma attack. Prophylactic inhalation of a patient's bronchodilator at the beginning of the appointment is a valuable method of preventing an asthma attack. Alternatively,

patients may be advised to bring their spirometer and daily expiratory record to the office. The dentist may request that the patient exhale into the spirometer and record the expired volume. A significant drop in lung function (to below 80% of peak FEV₁ or a greater than 10% drop from previously recorded values) indicates that prophylactic use of the inhaler or referral to a physician is needed.⁴⁵ The use of a pulse oximeter also is valuable for determining the patient's oxygen saturation level. In healthy patients, this value remains between 97% and 100%; a drop to 91% or below indicates poor oxygen exchange and the need for intervention.

Capacity to Tolerate Care. Because anxiety and stress are implicated as precipitating factors in asthma attacks and dental treatment may result in decreased lung function,⁴⁶ all dental staff members should make every effort to identify patients who are anxious and provide a stress-free environment through establishment of rapport and openness. Preoperative and intraoperative sedation may be desirable. If sedation is required, nitrous oxide–oxygen inhalation is best. Nitrous oxide is not a respiratory depressant, nor is it an irritant to the tracheobronchial tree. Oral premedication may be accomplished with small doses of a short-acting benzodiazepine. Reasonable alternatives with children are hydroxyzine (Vistaril), for its antihistamine and sedative properties, and ketamine, which causes bronchodilation.

Drug Considerations. Barbiturates and narcotics, particularly meperidine, are histamine-releasing drugs that can provoke an attack and thus should be avoided. Outpatient general anesthesia generally is contraindicated for patients with asthma.

Selection of local anesthetic may require adjustment. In 1987, the U.S. Food and Drug Administration³⁷ warned that drugs that contained sulfites were a cause of allergic-type reactions in susceptible individuals. Sulfite preservatives are found in local anesthetic solutions that contain epinephrine or levonordefrin, although the amount of sulfite in a local anesthetic cartridge is less than the amount commonly found in an average serving of certain foods. Although rare, at least one case of an acute asthma attack precipitated by exposure to sulfites has been reported.^{47,48} Thus, the use of local anesthetic without epinephrine or levonordefrin may be advisable for patients with moderate to severe disease. Because relevant data remain limited, the dentist should discuss with the patient any past responses to local anesthetics and allergy to sulfites and should consult with the physician on this issue. As an alternative, local anesthetics without a vasoconstrictor may be used in at-risk patients.

Patients with asthma who are medicated over the long term with high-dose systemic corticosteroids may require supplementation for major surgical procedures if their health is poor (see Chapter 15). However, long-term use of inhaled corticosteroids rarely causes adrenal suppression unless the daily dosage exceeds 1.5 mg of beclomethasone dipropionate or its equivalent.

Administration of aspirin-containing medication or other NSAIDs to patients with asthma is not advisable because aspirin ingestion is associated with the precipitation of asthma attacks in a small percentage of patients. Likewise, barbiturates and narcotics are best not used because they also may precipitate an asthma attack. Antihistamines have beneficial properties but should be used cautiously because of their drying effects. Patients who are taking theophylline preparations should not be given macrolide antibiotics (i.e., erythromycin and azithromycin) or ciprofloxacin hydrochloride because these agents interact with theophylline to produce a

potentially toxic blood level of theophylline. To prevent serious toxicity, the dentist should ask the patient who takes theophylline whether the dosage is being monitored on the basis of serum theophylline levels (recommended to be <10 $\mu\text{g}/\text{mL}$). Approximately 3% of patients who take zileuton exhibit elevated alanine transaminase levels, reflecting liver dysfunction that may affect the metabolism of dentally administered drugs.^{49,50}

Emergency (Asthma Attack). An acute asthma attack requires immediate therapy. The signs and symptoms (see Box 7.5) should be recognized quickly and an inhaler provided rapidly. A short-acting β_2 -adrenergic agonist inhaler (Ventolin, Proventil) is the most effective and fastest acting bronchodilator. It should be administered at the first sign of an attack. Long-lasting β_2 -agonist drugs such as salmeterol (Serevent) and corticosteroids do not act quickly and are not given for an immediate response, but they may provide a delayed response. With a severe asthma attack, use of subcutaneous injections of epinephrine (0.3–0.5 mL, 1:1000) or inhalation of epinephrine (Primatene Mist) is the most potent and fastest acting method for relieving the bronchial constriction. Supportive treatment includes providing positive-flow oxygenation, repeating bronchodilator doses as necessary every 20 minutes, monitoring vital signs (including oxygen saturation, if possible, which should reach 90% or higher), and activating the emergency medical system, if needed.⁵¹

Oral Complications and Manifestations

Nasal symptoms, allergic rhinitis, and mouth breathing are common with asthma. Asthmatics who are mouth breathers may have altered nasorespiratory function, which may be associated with increased upper anterior and total anterior facial height, higher palatal vault, greater overjet, and a higher prevalence of crossbite.⁵² Severe asthma in children is associated with dental enamel defects; in adults, severe asthma is associated with periodontitis.^{53,54}

The medications taken by patients who have asthma may contribute to oral disease. For example, β_2 -agonist inhalers reduce salivary flow by 20% to 35%, decrease plaque pH,⁵⁵ and are associated with increased prevalence of gingivitis and caries in patients with moderate to severe asthma.^{56,57} Gastroesophageal acid reflux is common in patients with asthma and is exacerbated by the use of β -agonists and theophylline. This reflux can contribute to erosion of enamel. Oral candidiasis (acute pseudo-membranous type) occurs in approximately 5% of patients who use inhalation steroids for long periods at high dose or frequency. However, development of this condition is rare if a “spacer” or aerosol-holding chamber is attached to the MDI and the mouth is rinsed with water after each use. The condition readily responds to local antifungal therapy (i.e., nystatin, clotrimazole, or fluconazole). Patients should receive instructions on the proper use of their inhaler and the need for oral rinsing. Headache is a frequent adverse effect of antileukotrienes and theophylline. The clinician should be aware of this adverse effect

when diagnosing disease in patients with orofacial pain complaints.

TUBERCULOSIS

Tuberculosis is an important human disease caused by an infectious and communicable organism, *Mycobacterium tuberculosis*. TB represents a major global health problem that is responsible for illness and deaths in large segments of the world's population. The disease is spread by inhalation of infected droplets and usually demonstrates a prolonged quiescent period. *M. tuberculosis* replication leads to an inflammatory and granulomatous response in the host, with consequent development of classic pulmonary and systemic symptoms. Although *M. tuberculosis* is by far the most common causative agent in this human infection, other species of mycobacteria occasionally infect humans, such as *M. avium complex*, *M. kansasii*, *M. abscessus*, *M. xenopi*, *M. bovis*, *M. africanum*, *M. microti*, and *M. canetti*. These mycobacterial species may cause systemic diseases (manifesting as pulmonary lymphadenitis, cutaneous, or disseminated) that are referred to as mycobacterioses.⁵⁸

EPIDEMIOLOGY

Tuberculosis has a worldwide incidence of 9 to 10 million, and the World Health Organization (WHO) estimates that one third of the world population—representing 2 billion people—is infected.⁵⁹ This disease kills more adults worldwide each year than does any other single pathogen.⁶⁰ In contrast, the occurrence of TB in the United States steadily decreased during the past century and has dropped at a rate of 5% per year over the past 50 years. Peak prevalence in Western countries occurred around the beginning of the 19th century. By the turn of the 20th century, approximately 500 new cases of active TB per 100,000 population were identified annually in the United States. By the mid-1980s, reports to the Centers for Disease Control and Prevention (CDC) indicated that the rate had decreased to 9.3 per 100,000 population. A resurgence in TB occurred between 1985 and 1992, when rates rose to 10.6 per 100,000 (i.e., 26,000 cases), primarily because of adverse social and economic factors, the acquired immunodeficiency syndrome (AIDS) epidemic, and immigration of foreign-born persons who had TB.⁶¹ Since then, the rate has steadily declined. In 2014, 9421 cases of TB were reported—representing a rate of 3 per 100,000.⁶² This was the lowest rate reported during the past century. Although the figures are encouraging, the disease continues to occur in almost every U.S. state and affects about 4% of the population (≈12 million people).⁶³ Moreover, 66% of new U.S. cases occur in foreign-born persons who migrate or travel to the United States—a rate that has consistently increased since 1993.⁶⁴

Although the present rate of infection for the United States as a whole is low, racial and ethnic minorities,

BOX 7.6 Groups at High Risk for Tuberculosis (TB)

- Close contacts of persons who have TB
- Skin test converters (within the past 2 years)
- Residents and employees of high-risk congregate settings (correctional facilities, nursing homes, mental institutions, homeless shelters, health care facilities)
- Recent immigrants and foreign-born persons (and migrant workers) from countries that have a high TB incidence or prevalence
- Persons who visit areas with a high prevalence of active TB, especially if visits are frequent or prolonged
- Populations defined as having increased incidence of latent *Mycobacterium tuberculosis* infection: medically underserved persons, those with low incomes, persons who abuse drugs or alcohol
- Infants, children, and adolescents exposed to persons who are at increased risk for latent *M. tuberculosis* infection or active TB or who have a positive result on tuberculin skin testing

Adapted from Mazurek GH, Jereb J, Vernon A, et al: Updated guidelines for using interferon gamma release assays to detect *Mycobacterium tuberculosis* infection—United States, 2010. *MMWR Recomm Rep* 59(RR-5):1-25, 2010.

residents of inner city ghettos, older adults, the urban poor, people living in congregate facilities (community dwellings, prisons, and shelters), and patients who have AIDS have occurrence rates that are several times the national average (Box 7.6). Higher risk for the disease (an 8% chance of developing TB per year) also has been noted in human immunodeficiency virus (HIV)—positive persons and in those who are immunosuppressed from use of medications.⁶¹ TB in the United States is diagnosed most often in men (with a male-to-female ratio of 1.6 to 1), foreign-born persons, Hispanics, African Americans, and Asian Americans (at rates 8, 8, and 28 times higher than that for whites, respectively) and in persons between 25 and 64 years of age.^{61,62}

Factors important in reducing the spread of TB in the United States during the past century have included improved sanitation and hygiene measures and the use of effective antituberculosis drugs. Unfortunately, failure to complete a course of therapy (a recognized problem in >20% of patients) and improper drug selection have contributed to the persistence of this disease and to the rise in the development of multidrug-resistant TB (MDR-TB), which has accounted for 1% of cases in the United States since 1997 but constitutes 5% of cases worldwide.^{61,62,65} MDR-TB disproportionately affects foreign-born persons in the United States, with countries such as China, India, and the Russian Federation accounting for more than 50% of all cases reported globally.

ETIOLOGY

In most cases of human TB, the causative agent is *M. tuberculosis*, an acid-fast, nonmotile, intracellular rod

that is an obligate aerobe. As an aerobe, this organism exists best in an atmosphere of high oxygen tension; therefore, it most commonly infects the lung.

M. tuberculosis typically is transmitted by way of infected airborne droplets of mucus or saliva that are forcefully expelled from the lungs, most commonly through coughing but also by sneezing and during talking. The quantity and size of expelled droplets influence transmission. Smaller droplets evaporate readily, leaving bacteria and other solid material as floating particles that are easily inhaled. Larger droplets quickly settle to the ground. Transmission by way of fomites rarely occurs.^{58,66} Transmission by ingestion (e.g., of contaminated milk) occurs but is rare because of the use of pasteurized milk. A secondary mode of transmission—by ingestion—is possible when a patient coughs up infected sputum, thereby inoculating oral tissues. Oral lesions of TB may be initiated through this mechanism.

The interval from infection to development of active TB is widely variable, ranging from a few weeks to decades. Most cases of TB result from reactivation of a dormant tubercle; only 5% to 10% of cases arise *de novo* at the time of the initial infection. The number of organisms inhaled and the level of immunocompetency largely determine whether an exposed person will contract the disease.

PATHOPHYSIOLOGY AND COMPLICATIONS

Tuberculosis can involve virtually any organ of the body, although the lungs are the most common site of infection. The typical infection of primary pulmonary TB begins with inhalation of infected droplets. These droplets are carried into the alveoli, where bacteria are engulfed by macrophages. Replication occurs within alveolar macrophages, and spread of infection occurs locally to regional (hilar) lymph nodes. The combination of a primary granulomatous lung lesion and an infected hilar lymph node is known as a Ghon complex. If the infection is not controlled locally, distant dissemination through the bloodstream may occur. However, the vast majority of disseminated bacteria are destroyed by natural host defenses. At approximately 2 to 8 weeks after onset, delayed hypersensitivity to the bacteria develops that is mediated by T (CD4⁺) helper lymphocytes. This condition manifests as conversion of the tuberculin skin testing (using purified protein derivative [PPD], as described later on) from negative to positive. Subsequently, a chronic granulomatous inflammatory reaction develops that involves activated epithelioid macrophages and formation of granulomas. These natural host defenses usually control and contain the primary pulmonary TB infection, resulting in latent TB infection (LTBI). If not contained, the nidus of infection (granuloma) may become a productive tubercle with central necrosis and caseation. Cavitation may

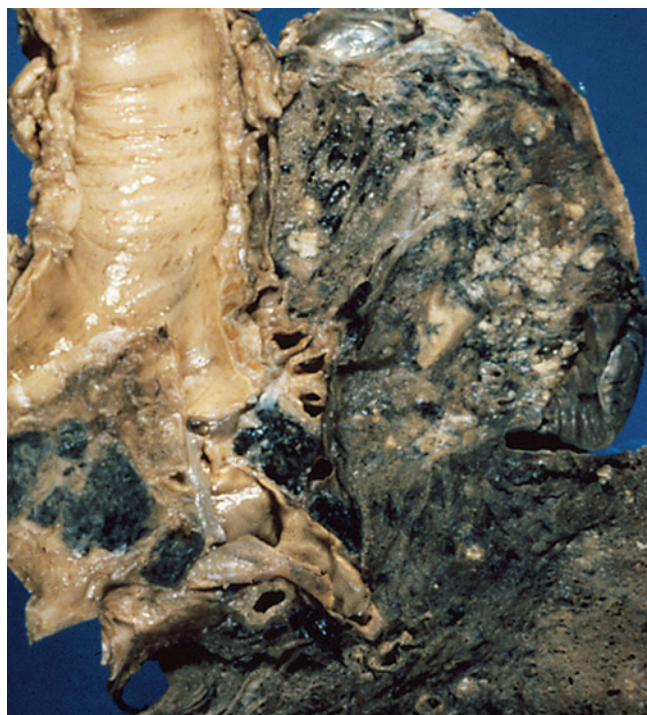

FIG 7.9 Gross specimen of a tuberculous lung, demonstrating caseating granulomas and cavitation. (Courtesy of R. Powell, Lexington, KY.)

occur (Fig. 7.9), resulting in the dumping of organisms into the airway for further dissemination into other lung tissue or the exhaled air.⁵⁹

Limitation and local containment of infection may be influenced by a variety of factors, including host resistance, host immune capabilities, and virulence of the mycobacterium. After the infection has been successfully interrupted, the lesion heals spontaneously and then undergoes inspissation, hardening, encapsulation, and calcification. Although the lesion “heals,” some bacteria may remain dormant. If infection is not interrupted, dissemination of bacilli may occur through the lung parenchyma, resulting in extensive pulmonary lesions and lymphohematogenous spread. Widespread infection with multiple organ involvement is called *miliary TB*.

Primary pulmonary TB is seen most often in infants and children; however, cavitation is rare in these age groups, and children generally do not actively produce or expectorate sputum; they instead usually swallow any pulmonary secretions. Expression of the disease differs somewhat in teenagers and adults in that lymph node involvement and lymphohematogenous spread are not prominent features. However, cavitation commonly occurs. The usual form of disease found in adults is called secondary or reinfection TB, which occurs with delayed reactivation of persistent dormant viable bacilli and probably represents relapse of a previous infection. This form of the disease usually is confined to the lungs, and cavitation

is common. Reasons for relapse include inadequate treatment of the primary infection and the influences of illness, immunosuppressive agents, immunodeficiency disease (as in AIDS), and age.

Some of the more common sequelae of TB include progressive primary TB, cavitory disease, pleurisy and pleural effusion, meningitis, and disseminated or miliary TB. Isolated organ involvement other than that of the lung may occur, with the pericardium, peritoneum, kidneys, adrenal glands, and bone (known as Pott disease when occurring in the spine) commonly affected.⁵⁶ The tongue and other tissues of the oral cavity also are involved, albeit infrequently. Factors that increase the risk of a poor clinical outcome are listed in [Box 7.7](#).

Risk of progression from LTBI to TB is largely a function of the immune status of the host.⁵⁹ The rate of reactivation from LTBI is 0.05 per 100 person-years, or about 5% over a person's lifetime, if the person is not HIV infected.⁶⁷ In HIV-infected persons who have LTBI, there is a 7% to 10% annual risk of progression to TB. Approximately 5% to 10% of persons who develop TB die of the disease. The rate of deaths attributable to TB is much higher in persons who do not receive adequate treatment and in persons who have severe immune suppression (i.e., AIDS).⁶⁸

BOX 7.7 Persons at Increased Risk for Progression of Infection to Active Tuberculosis (TB)

- Persons with human immunodeficiency virus infection
- Infants and children younger than 5 years of age
- Persons who are receiving immunosuppressive therapy such as with TNF- α antagonists, systemic corticosteroids equivalent to 15 mg or more of prednisone per day, or immunosuppressive drug therapy after organ transplantation
- Persons who were recently infected with *Mycobacterium tuberculosis* (within the past 2 years)
- Persons with a history of untreated or inadequately treated active TB, including persons with fibrotic changes on chest radiographs consistent with previous active TB
- Persons with silicosis; diabetes mellitus; chronic renal failure; leukemia; lymphoma; solid organ transplant; or cancer of the head, neck, or lung
- Persons who have had a gastrectomy or jejunioleal bypass
- Persons who are underweight (weigh <90% of their ideal body weight) or malnourished
- Cigarette smokers and persons who abuse drugs or alcohol
- Populations defined locally as having an increased incidence of active TB, possibly including medically underserved and low-income populations

TNF- α , Tumor necrosis factor- α .

Adapted from Mazurek GH, Jereb J, Vernon A, et al: Updated guidelines for using interferon gamma release assays to detect *Mycobacterium tuberculosis* infection—United States, 2010. *MMWR Recomm Rep* 59(RR-5):1-25, 2010.

CLINICAL PRESENTATION

Signs and Symptoms

Primary infection with *M. tuberculosis* in about 90% of patients results in few manifestations other than a positive result on tuberculin skin testing and characteristic radiographic changes. Progression of clinical disease usually is associated with underlying conditions (young and old ages) and diseases that depress the immune response. When symptoms become apparent, they typically are nonspecific and could be associated with any infectious disease. They include cough, lassitude and malaise, anorexia, unexplained weight loss, night sweats, and fever. Temperature elevation commonly occurs in the evening or during the night and is accompanied by profuse sweating.⁵⁹

Specific local symptoms of the disease depend on the organ involved. Persistent cough is the symptom most commonly associated with pulmonary TB, although it may appear late in the course of the disease. Cough is common with cavitory disease. The sputum produced is characteristically scanty and mucoid, but it becomes purulent with progressive disease. Hemoptysis (blood in sputum) is infrequent, occurring in about 20% of cases. Dyspnea is a feature of advanced disease.

Manifestations of extrapulmonary disease occur in about 10% to 20% of cases, more often in HIV-infected persons, and may include localized lymphadenopathy with the development of sinus tracts, back pain over the affected spine, gastrointestinal disturbances (in intestinal TB), dysuria and hematuria (in renal involvement), heart failure, and neurologic deficits.⁶⁹

LABORATORY AND DIAGNOSTIC FINDINGS

Laboratory tests are directed toward determining whether the patient has active infection or LTBI. Active infection is considered when there is a positive acid-fast bacillus sputum smear, symptoms are present (cough, fever, weight loss, night sweats), and characteristic chest radiographic changes are observed. The definitive diagnosis of TB is based on culture or direct molecular tests (e.g., nucleic acid amplification) that identify *M. tuberculosis* or other mycobacterial species from body fluids and tissues, usually sputum. Three consecutive morning sputum specimens are obtained for culturing to ensure positive results.⁵⁸ With traditional culture techniques, 2 to 3 weeks are required to grow mycobacteria on solid medium; however, the use of selective broth (BACTEC-460; Becton-Dickson, Sparks, MD) or similar systems reduces the time to about 1 week.^{59,70} Nucleic acid amplification assay can detect mycobacterium within 48 hours. Cultures should be accompanied by antimicrobial susceptibility testing for all isolates of *M. tuberculosis* because of the rising incidence of multiple drug resistance and extensively drug-resistant TB. Drug resistance can be assessed using the Xpert MTB/RIF (Cepheid, Sunnyvale, CA) or Line

Probe Assay (Hain LifeScience, Nehren, Germany). Some tests (i.e., skin testing, sputum smears, cultures, and chest films) are less reliable when the patient has HIV infection.

Radiographic findings in TB include patchy or lobular infiltrates in the apical posterior segments of the upper lobes or in the middle or lower lobes, with cavitation and hilar adenopathy in active “progressive primary” TB. Healed primary lesions leave a calcified peripheral nodule associated with a calcified hilar lymph node (Ghon complex).

Latent TB infection can be diagnosed using either the tuberculin (Mantoux) skin test (tuberculin skin test [TST])⁷¹ or a blood test known as the interferon-gamma release assay (IGRA).⁷² The TST is 95% sensitive and 95% specific for determining whether the patient has been infected with *M. tuberculosis*. This test is of limited utility in immunocompromised persons and during the first 6 to 8 weeks, when the bacillus is incubating because false-negative results are likely.⁷³ Also, for various reasons, 10% to 25% of people with active TB have false-negative skin test results. A positive test result presumptively means that the person has been infected. It does not mean that the person has clinically active TB. Some positive skin reactions indicate infection with other mycobacterial species. Physical examination and tests that identify *M. tuberculosis* are required for diagnosis.

The TST is administered by intradermal injection of 0.1 mL of PPD, which contains 5 units of tuberculin (culture extract from *M. tuberculosis*), on the volar or dorsal surface of the forearm. The test measures the delayed hypersensitivity response by evidence of induration noted 48 to 72 hours later. The size of the induration determines whether the results are read as negative (induration size <5 mm) or positive (with 10 and 15 mm used as cut points), interpreted in light of the presence of risk factors, abnormalities on the chest radiographs, and risk of disease progression (Table 7.2). Induration of 15 mm or greater is considered positive evidence of TB in all persons tested.⁷¹ A positive result on PPD testing

necessitates a physical examination, a radiographic evaluation, and, if necessary, sputum culture to rule out active disease. Without treatment, approximately 5% of skin test converters develop TB within 2 years; another 5% develop it later.⁷⁴ Thus, all persons who are at risk for development of TB—including dentists—should undergo LTBI testing annually.

IGRAs are performed on fresh whole blood as an alternative to the TST (except in children younger than 5 years of age). IGRAs are commercially available in the United States as QuantiFERON-TB Gold-in-Tube test or T-SPOT TB test. These tests measure the person’s immune reactivity to white blood cells infected with *M. tuberculosis*, which release interferon- γ when mixed with antigens from the mycobacteria. These assays are advantageous because they can detect recent infections, results are available within 24 hours, and previous bacille Calmette-Guérin (BCG) vaccination does not cause a false-positive result. Similar to the TST, however, they cannot discriminate active from latent infection.⁷²

MEDICAL MANAGEMENT

Treatment protocols for TB are directed toward whether the patient has LTBI or active TB. Most persons who have LTBI (i.e., those with inactive disease) are not candidates for treatment, unless they are considered at high risk for disease progression (see Box 7.7). The standard regimen for those with LTBI designated as high risk for disease progression is isoniazid (INH), 300 mg daily for 9 months (10 mg/kg for 9 months in children).⁷⁵ Alternatively, a 6-month course with INH, a 12-dose once-weekly (3-month) regimen of INH and rifampine, or a 4-month regimen of rifampin can be used. Although these regimens usually prevent the occurrence of active disease, the treated person retains hypersensitivity to PPD, so skin tests and IGRA will continue to give positive results.⁷⁶

The International Standards for Tuberculosis Care (ISTC) and the American Thoracic Society/CDC

TABLE 7.2 Significance of Positive Results on Purified Protein Derivative Testing

Groups at Risk for Progression to Active TB Disease, Stratified by Induration Size		
Positive IGRA Result or a TST Reaction of ≥ 5 mm	Positive IGRA Result or TST Induration ≥ 10 mm	TST Induration ≥ 15 mm
<ul style="list-style-type: none"> • HIV-infected persons • Recent contacts of a TB case • Persons with fibrotic changes on chest radiographs consistent with old TB • Persons who are immunosuppressed for other reasons (e.g., taking the equivalent of >15 mg/day of prednisone for 1 month or longer; taking TNF-α antagonists) 	<ul style="list-style-type: none"> • Children younger than <5 years of age and children and adolescents exposed to adults in high-risk categories • Recent immigrants (<5 years) from high prevalence countries • Injection drug users • Residents and employees of high-risk congregate settings • Mycobacteriology laboratory personnel 	<p>All persons in this category are considered to have TB (despite absence of risk factors for TB)</p>

HIV, Human immunodeficiency virus; IGRA, interferon-gamma release assay; TB, tuberculosis; TNF- α , tumor necrosis factor- α ; TST, tuberculin skin test.

BOX 7.8 Common Drug Regimens for the Treatment of Tuberculosis (TB)

Drug-Susceptible TB

- Four-drug, *initial phase* regimen (isoniazid + rifampin + ethambutol + pyrazinamide) for 2 months
- Then two-drug, *continuation phase* therapy (isoniazid and rifampin) for 4 months (18 weeks) or for 7 months if patients (1) have cavitary pulmonary tuberculosis caused by drug-susceptible organisms and whose sputum culture obtained at the time of completion of 2 months of treatment is positive; (2) whose initial phase of treatment did not include pyrazinamide; and (3) patients being treated with once-weekly INH and rifampin and whose sputum culture obtained at the time of completion of the initial phase is positive

Confirmed Multidrug-Resistant TB*

- Five-agent regimen: pyrazinamide + a fluoroquinolone, an injectable drug—(amikacin or kanamycin), ethionamide, and either cycloserine or para-aminosalicylic acid—to which the organism is susceptible, continued for at least 8 months up to 20 months. Treatment regimens are individualized in accordance with several factors, including resistance pattern, extent of disease, and presence of comorbid conditions.

**Multidrug-resistant TB* is defined as TB resistant to therapy with isoniazid (INH) and rifampin.

Data from Treatment of tuberculosis. *MMWR Recomm Rep* 52 (RR11):1-77, 2003 and Guidelines for the programmatic management of drug-resistant tuberculosis: 2011 update. World Health Organization, Geneva, 2011.

recommendations^{77,78} for effective chemotherapy for active TB include the following: early and accurate diagnosis should be established; prompt initiation of effective treatment, standardized treatment regimens that involve multiple drug use; treatment and response to treatment should be monitored to ensure full course of therapy is taken; patient education and compliance; and appropriate public health measures. Of particular concern are patient compliance and completion of therapy, as well as exposure of personal contacts, who may be at risk for the disease.

The ISTC and CDC currently recommend that all patients receive at least a four-drug, initial phase regimen of INH, rifampin, ethambutol, and pyrazinamide.^{77,78} The four-drug regimen is given for 2 months, and a sputum specimen is collected to determine response to therapy. If the specimen is negative for *M. tuberculosis*, INH and rifampin are given daily or twice weekly for the next 4 months, for a total of 6 months of therapy. If, however, at 2 months, the sputum is positive, cavitation pulmonary TB is present, or the initial phase of treatment did not include pyrazinamide, then the continuation phase of INH and rifampin–rifampin should be extended for 3 additional months, for a total of 7 months (Box 7.8).

After the initiation of chemotherapy, reversal of infectiousness depends on proper drug selection and patient compliance. Within 3 to 6 months, approximately 90% of patients become noninfectious, and their sputum cultures

convert to negative.⁷⁹ Patients are allowed to return to normal public contact on the basis of reversal of infectiousness and continued chemotherapy. When compliance is not encouraged and monitored, only 76% to 83% of patients complete indicated therapy.⁸⁰

Because of its contagiousness and the problem of less than ideal compliance with treatment regimens, protection measures have been introduced to control the spread of disease. Public health measures include screening close contacts for the disease, hospitalizing patients with potentially infectious TB, and treating infected patients in isolation rooms with negative air pressure.⁸¹ In addition, “directly observed therapy” and text reminders are used to ensure that infected patients take the appropriate medicine at the appropriate time for the duration of therapy.

MDR-TB, defined by the WHO as resistant to two first-line antituberculosis drugs, is a threatening feature of the disease affecting 480,000 persons worldwide in 2013. MDR-TB occurs in 1.3% of cases in the United States, about 5% globally, and more than 10% of cases in parts of the former Soviet Union (Russian Federation) and China.^{60,82} Ninety percent of drug-resistant cases occur in HIV-infected persons and in many countries where TB is endemic.⁸³ Transmission of drug-resistant TB has occurred between patients, between patients and health care workers, and between patients and family members. To limit the spread of MDR-TB, sputum cultures should be tested for drug-resistant bacteria if drug resistance is likely or sputum specimens remain positive. Current guidelines recommend that at least five antituberculosis medications that have been shown to be susceptible by laboratory testing be prescribed in a stepwise manner and treatment be provided in a hospital using directly observed therapy (see Box 7.8). Mortality rates range from 25% to 40%, even when a five-drug regimen is given for 20 months.

More threatening is extensively drug-resistant (XDR)-TB, which is defined as a rare type of MDR-TB that is resistant to the two best first-line drugs (INH and rifampin) as well as resistant to the best second-line medications. Globally, about 9% of MDR-TB cases are XDR-TB.⁸² Sixty-three cases of XDR-TB were reported in the United States between 1993 and 2011. Successful treatment depends on disease severity, immune status, and adherence to treatment.⁸⁴ Death occurs in more than 20% of cases.

DENTAL MANAGEMENT

Identification. Many patients with infectious disease, including TB, cannot be clinically or historically identified; therefore, all patients should be treated as though they are potentially infectious, and the CDC’s standard precautions for infection control should be strictly followed. Implementation of infection control measures for patients with TB involves updating each patient’s medical history, recognizing the signs and symptoms of TB, and following

the guidelines of the CDC for infection control and the prevention of transmission of TB in health care facilities (see [Appendix B](#)).⁸¹ These guidelines address administrative, environmental, and respiratory protection controls for outpatient health care settings such as dental offices. The CDC places most dental facilities in the low-risk category for potential occupational exposure to TB. In keeping with this risk category, it recommends that each dental facility have a written TB control protocol that includes instrument reprocessing and operatory cleanup, as well as protocols for identifying, managing, and referring patients with active TB and educating and training staff ([Box 7.9](#)). The CDC also recommends that baseline and periodic screening of dental care workers with PPD be provided to document any recent exposure and that protocols be available that explain how the office assesses,

manages, and investigates dental staff members with a positive result on PPD testing.⁸¹

Risk Assessment. Management of patients infected with TB is based on potential infectivity status and risk for spread of infection. The four infectivity categories are (1) active TB, (2) a history of TB, (3) a positive tuberculin test or IGRA, and (4) signs or symptoms suggestive of TB ([Box 7.10](#)).

Patients With Clinically Active Sputum-Positive Tuberculosis. Patients with recently diagnosed, clinically active TB and positive sputum cultures should not be treated on an outpatient basis. Treatment is best rendered in a hospital setting with appropriate isolation, sterilization (mask, gloves, gown), and special engineering control (ventilation) systems and filtration masks. For greater detail, clinicians should refer to the CDC recommendations

BOX 7.9 Centers for Disease Control and Prevention Guidelines: Tuberculosis (TB) Precautions for Use in Outpatient Dental Settings

Administrative Controls

- Assign responsibility for managing TB infection control program.
- Conduct annual risk assessments.
- Develop written TB infection control policies for promptly identifying and isolating patients with suspected or confirmed TB for medical evaluation or urgent treatment.
- Ensure dental health care personnel are educated regarding the signs and symptoms of TB.
- Instruct patient to cover mouth when coughing and to wear a surgical mask.
- Screen newly hired personnel for latent TB infection and disease.
- Postpone urgent dental treatment if TB is suspected or active.

Environmental Controls

- Use airborne infection isolation room to provide urgent treatment to patients with suspected or confirmed TB.
- Use high-efficiency particulate air filters or UV-germicidal irradiation in settings with a high volume of patients with suspected or confirmed TB.
- Cover and clean and disinfect exposed patient area surfaces.
- Sterilize patient care items.

Respiratory Protection Controls

- Use respiratory protection (at least an N95 filtering face piece [disposable], N99 or N100 respirators) for exposed personnel when they are providing urgent dental treatment to patients with suspected or confirmed TB.
- Instruct TB patients to cover their mouth when coughing and to wear a surgical mask.

UV, Ultraviolet.

Data from Jensen PA, Lambert LA, Iademarco MF, Ridzon R: CDC: Guidelines for preventing the transmission of *Mycobacterium tuberculosis* in health-care settings, 2005. *MMWR Recomm Rep* 54(RR-17):1-142, 2005.

BOX 7.10 Principles of Dental Management for Patients With a History of Tuberculosis

Active Sputum-Positive Tuberculosis

- Consult with a physician before treatment.
- Perform urgent care only; palliate urgent problems with medication if contained facility in a hospital environment is not available.
- Perform urgent care that requires the use of a handpiece (in patients older than 6 years) only in a hospital setting with isolation, sterilization (gloves, mask, gown), and special respiratory protection.
- Treat those less than 6 years of age as a normal patient (noninfectious after consultation with physician to verify status).
- Treat patients who consistently produce negative sputum as normal (noninfectious—verify with physician).

Tuberculosis History Specifics

- Approach with caution; obtain thorough history of disease and its treatment duration, with appropriate review of systems.
- Obtain from patient a history of periodic chest radiographs and physical examination to rule out reactivation or relapse.
- Consult with physician and postpone treatment with identification of any of the following:
 - Questionable adequacy of treatment time
 - Lack of appropriate medical follow-up evaluation since recovery
 - Sign or symptom of relapse
- Treat as for normal patient if present status is “free of clinically active disease.”

Recent Conversion to Positive Tuberculin Skin Test

- Verify evaluation by physician to rule out active disease.
- Verify completion of drug therapy with isoniazid for 9 months.
- Treat as normal patient.

Signs or Symptoms Suggestive of Tuberculosis

- Refer to a physician and postpone treatment.
- Treat as for a patient with sputum-positive status if treatment is necessary.

available at <http://www.cdc.gov/mmwr/pdf/rr/rr5417.pdf>. Also, because of the risk of TB transmission, treatment should be restricted to urgent care in an isolation room, and a rubber dam should be used to minimize aerosolization of oropharyngeal microbes. After receiving chemotherapy for at least 2 to 3 weeks and after receiving confirmation from the physician that he or she is noninfectious and lacks any complicating factors, the patient may be treated on an outpatient basis in the same manner as for any normal, healthy person⁸⁵ (Box 7.11).

A child with active TB who is receiving chemotherapy usually can be treated as an outpatient because bacilli are found only rarely in the sputum of young children. The child should be considered noninfectious unless a positive sputum culture has been obtained.⁸⁶ Reasons why a child with TB is considered noninfectious include the rarity of cavitory disease in children and their inability to cough up sputum effectively. In this context, defining exactly what age constitutes a “child” is difficult. As a general rule, children younger than 6 years of age who are receiving anti-TB drugs can be confidently treated. At the age of 6 years and beyond, some degree of concern is in order. The physician should be consulted before treatment is begun. Of greater concern in such cases is the TB status of family contacts of the patient because the disease most likely was contracted from an infected adult. All family members who have had contact with the child should provide a history of skin testing and chest radiography to rule out the possibility of active disease. If such assurances are not obtained, the physician or health department should be contacted to ensure that proper preventive action is taken.

Patients With a Past History of Tuberculosis. Fortunately, relapse is rare among patients who have received adequate treatment for the initial infection. This is not the case, however, in patients who have received inadequate treatment and in those who are immunosuppressed. Regardless

BOX 7.11 General Guidelines for Determining When a Patient With Pulmonary Tuberculosis (TB) Has Become Noninfectious During Therapy

- Likelihood of multidrug-resistant TB has been determined to be negligible
- Patient has received standard multidrug anti-TB therapy for 2 to 3 weeks
- Patient has demonstrated compliance with standard multidrug anti-TB treatment
- Patient exhibits clinical improvement
- Results of AFB testing on three consecutive sputum smears are negative
- All close contacts of the patient have been identified; evaluated; advised; and, if indicated, started on treatment for latent TB infection.

AFB, Acid-fast bacilli.

of what type of treatment was received, any person with a history of TB requires an initial careful workup to investigate infectivity status before any dental treatment is contemplated. The dentist should obtain a medical history, including diagnosis and dates and type of treatment. Treatment duration of less than 18 months if treatment was provided more than 2 decades ago, or less than 9 months if treatment was given before the year 2000, requires consultation with the physician to assess adequacy of the regimen used. Patients should provide a history of periodic physical examinations and chest radiographs to check for evidence of reactivation of the disease. Further consultation with the physician is advisable to verify the patient’s current status. Patients who are found to be free of active disease and are not immunosuppressed may be treated with the use of standard precautions. A thorough review of systems is important with these patients, and referral to a physician is indicated if questionable signs or symptoms are present.

Patients With a Positive Tuberculin Test or Positive IGRA. A person with a positive result on skin testing for TB or IGRA should be viewed as having been infected with mycobacteria. The patient should provide a history of being evaluated for active disease by physical examination and chest radiography. In the absence of clinically active disease, such patients have LTBI and are not considered infectious. A regimen of prophylactic INH is typically administered for 9 months if they are considered to be at risk for disease progression (see Box 7.7). These patients may be treated in a normal manner with the use of standard precautions.

Patients With Signs or Symptoms Suggestive of TB. Any time a patient demonstrates unexplained, persistent signs or symptoms that may be suggestive of TB (e.g., dry nonproductive cough, pleuritic chest pain, fatigue, fever, dyspnea, hemoptysis, weight loss) or has a positive result on skin testing or positive IGRA and has not been given follow-up medical care, dental care should not be rendered, and the patient should be referred to a physician for evaluation. If a health care provider is exposed to TB, the provider should be evaluated for TB infection. Skin test converters and persons with positive IGRA results should be treated promptly with INH.⁷⁸

Recommendations

Airway and Breathing. There are no issues with breathing and contagiousness in patients with LTBI; however, those with active TB have compromised pulmonary function and are infectious. Thus, these patients should not be treated in a dental setting until their condition is medically managed.

Bleeding. INH and rifampin can lower the platelet count and increase the risk of bleeding. A complete blood count should be obtained when an invasive procedure is planned for these patients.

Capacity to Tolerate Care. An active TB patient can tolerate dental care after receiving (1) appropriate anti-TB

chemotherapy for at least 2 to 3 weeks and (2) confirmation is received from the physician that the patient is noninfectious and lacks any complicating factors (see [Box 7.11](#)).

Drug Considerations. Several anti-TB drugs have notable adverse effects and drug interactions in which dentists should be knowledgeable. INH, rifampin, and pyrazinamide therapy may cause hepatotoxicity and elevations in serum aminotransferases ([Table 7.3](#)). The prevalence of INH-induced hepatitis is about 0.6% and increases with advancing age, daily alcohol intake, previous liver disease, and concurrent use of other anti-TB drugs (rifampin with pyrazinamide).⁸⁷ When serum aminotransferases are elevated in patients taking INH, acetaminophen-containing medications should be avoided because of the increased potential for hepatotoxicity. Additional precautions regarding liver dysfunction, including drug dosage reductions, are discussed in [Chapter 10](#).

Rifampin induces cytochrome P-450 enzymes. As a result, the use of rifampin can lower plasma levels of oral contraceptives, diazepam, midazolam, clarithromycin (Biaxin), ketoconazole (Nizoral), itraconazole (Sporanox), and fluconazole (Diflucan). In addition, rifampin can cause leukopenia, hemolytic anemia, and thrombocytopenia, resulting in an increased incidence of infection, delayed healing, and gingival bleeding. Regimens that combine

rifampin with pyrazinamide or INH increase the risks for hepatotoxicity and gastrointestinal and neurologic adverse events. Streptomycin should not be administered concurrently with aspirin because of the potential for ototoxicity.

Oral Complications and Manifestations

Tuberculosis manifests infrequently in the oral cavity. Oral lesions can occur at any age but most frequently are seen in men about 30 years of age and in children. The classic mucosal lesion is a painful, deep, irregular ulcer on the dorsum of the tongue. The palate, lips, buccal mucosa, and gingiva also may be affected. Mucosal lesions have been reported to be granular, nodular, or leukoplakic and sometimes painless. Extension into the jaws can result in osteomyelitis.⁸⁸ The cervical and submandibular lymph nodes may become infected with TB; this condition is called *scrofula*. The nodes become enlarged and painful ([Fig. 7.10](#)), and abscesses may form with subsequent drainage.⁷⁶ Involvement of the salivary glands or temporomandibular joint is rare.^{89,90}

Biopsy in addition to culture can be diagnostic if acid-fast bacilli are found. Resolution of the infectious oral lesion may result from treatment of TB with antituberculosis drugs. Pain is managed symptomatically (see [Appendix C](#)).

TABLE 7.3 Dental Treatment Considerations With Antituberculosis Drugs

Drug (Trade Name)	Adverse Effects	Dental Considerations
Isoniazid (INH) (Laniazid, Nydrazid, Tubizid)	Hepatotoxicity; elevation in serum aminotransferase activity in 10%–20% of patients*; rash, fever, peripheral neuropathy	Avoid acetaminophen Increases the concentrations of other drugs (e.g., diazepam)
Rifampin (Rifadin, Rimactane), Rifabutin, Rifapentine	Hepatotoxicity; GI disturbances, flulike symptoms, thrombocytopenia, rash; turns urine red-orange	Increases the incidence of infection, delayed healing, gingival bleeding; bidirectional interaction that decreases serum levels of diazepam, triazolam, erythromycin, clarithromycin (Biaxin), ketoconazole (Nizoral), itraconazole (Sporanox), fluconazole (Diflucan), and oral contraceptives
Pyrazinamide (generic)	Arthralgias, rash (photoallergy), hyperuricemia, GI disturbances, arthralgias, and hepatitis	—
Ethambutol (Myambutol)	Decreased red-green color discrimination; reduced visual acuity; optic neuritis (rare)	—
Ethionamide (Trecator-SC)	—	—
Streptomycin (generic)	Ototoxicity, vestibular disturbances, infrequent renal toxicity, perioral numbness	Avoid concurrent use of aspirin
Amikacin (Amikin), kanamycin (Kantrex), capreomycin (Capastat)	Nephrotoxicity and ototoxicity	Avoid concurrent use of aspirin
Cycloserine	Neurotoxicity and hypersensitivity, vitamin deficiency	—
Aminosalicylic acid (Sodium P.A.S., Teebacin)	GI disturbances	—

*Greater risk of liver damage in persons older than 35 years of age; vitamin B₆ (pyridoxine) is recommended to counteract the potential for adverse effects of INH.

GI, Gastrointestinal.



FIG 7.10 Tuberculosis of the cervical lymph nodes.

OCCUPATIONAL SAFETY AND HEALTH ASSOCIATION

Dentists should be aware that the Occupational Safety and Health Association (OSHA) issued an enforcement guidance policy in 1993 to protect workers against exposure to *M. tuberculosis* and continues to mandate directives as public policy.⁹¹ Current policy mandates that employers provide a safe, healthful workplace and permit inspection for occupational exposure to TB in health care facilities when complaints are received from public sector employees. Employers who are found to be in violation of the requirements may be fined.

Since 1997, OSHA has mandated a specific policy regarding the risk of TB transmission based on CDC guidelines. Current policy can be viewed at <http://www.osha.gov/SLTC/tuberculosis/index.html>, which requires that dentists prepare a written exposure control plan, provide baseline skin test results and medical history, make medical management available after an exposure incident, provide medical removal protection if necessary, provide information and training to employees with exposure potential, comply with record-keeping requirements, and document any occupationally related tuberculosis infection. In addition, if respirators are deemed necessary to protect the health of an employee, the employer is required to establish and implement a written respiratory protection program. Periodic medical surveillance and respiratory protection are not required if the dental facility does not admit or treat patients with active TB, has not had a confirmed case of infectious TB within the past year, and is located in a county in which cases of active TB have not been reported within the previous 2 years. By contrast, stricter guidelines (i.e., isolation rooms for patients with suspected or confirmed infectious TB and use of ventilation equipment) are provided for instances in which employees may have been exposed to the exhaled air of a person with suspected or confirmed TB or were exposed to a high-hazard procedure performed

on a person who may have TB that has the potential to generate aerosols containing potentially infectious respiratory secretions. OSHA requires use of personal protective equipment to reduce employee exposure to hazards. To familiarize themselves with their legal responsibilities, dentists should visit OSHA's website at https://www.osha.gov/pls/oshaweb/owasrch.search_form?p_doc_type=STANDARDS&p_toc_level=0&p_keyvalue=.

REFERENCES

1. Niewoehner D. Chronic obstructive pulmonary disease. In: Goldman L, Schafer A, eds. *Goldman-Cecil Medicine*. Philadelphia: Saunders/Elsevier; 2016:555-562.
2. Global Initiative for Chronic Obstructive Lung Disease. Global Strategy for the Diagnosis, Management and Prevention of Chronic Obstructive Lung Disease Updated 2016. (Available on): [http://www.goldcopd.org/uploads/users/files/WatermarkedGlobalStrategy2016\(1\).pdf](http://www.goldcopd.org/uploads/users/files/WatermarkedGlobalStrategy2016(1).pdf). Accessed 24 February 2016.
3. Centers for Disease Control and Prevention. Deaths from chronic obstructive pulmonary disease—United States, 2000-2005. *MMWR Morb Mortal Wkly Rep*. 2008;57(45):1229-1232.
4. American Lung Association. Trends in COPD (Chronic Bronchitis and Emphysema): Morbidity and Mortality. <http://www.lung.org/assets/documents/research/copd-trend-report.pdf>. Accessed 24 February 2016.
5. Mannino DM, Gagnon RC, Petty TL, et al. Obstructive lung disease and low lung function in adults in the United States: data from the National Health and Nutrition Examination Survey, 1988-1994. *Arch Intern Med*. 2000;160(11):1683-1689.
6. Hagstad S, Bjerg A, Ekerljung L, et al. Passive smoking exposure is associated with increased risk of COPD in never smokers. *Chest*. 2014;145(6):1298-1304.
7. Anto JM, Vermeire P, Vestbo J, et al. Epidemiology of chronic obstructive pulmonary disease. *Eur Respir J*. 2001;17(5):982-994.
8. Viegi G, Pistelli F, Sherrill DL, et al. Definition, epidemiology and natural history of COPD. *Eur Respir J*. 2007;30(5):993-1013.
9. Eisner MD, Balmes J, Katz PP, et al. Lifetime environmental tobacco smoke exposure and the risk of chronic obstructive pulmonary disease. *Environ Health*. 2005;4(1):7.
10. Salvi S. Tobacco smoking and environmental risk factors for chronic obstructive pulmonary disease. *Clin Chest Med*. 2014;35(1):17-27.
11. Curkendall SM, DeLuise C, Jones JK, et al. Cardiovascular disease in patients with chronic obstructive pulmonary disease, Saskatchewan Canada cardiovascular disease in COPD patients. *Ann Epidemiol*. 2006;16(1):63-70.
12. Barnes PJ, Celli BR. Systemic manifestations and comorbidities of COPD. *Eur Respir J*. 2009;33(5):1165-1185.
13. Ahmed-Sarwar N, Pierce DP, Holub DC. COPD: optimizing treatment. *J Fam Pract*. 2015;64(10):610-623.

14. Barnes PJ. New therapies for chronic obstructive pulmonary disease. *Med Princ Pract.* 2010;19(5):330-338.
15. Abramson MJ, Crockett AJ, Frith PA, et al. COPDX: an update of guidelines for the management of chronic obstructive pulmonary disease with a review of recent evidence. *Med J Aust.* 2006;184(7):342-345.
16. Ramseier CA, Warnakulasuriya S, Needleman IG, et al. Consensus report: 2nd European workshop on tobacco use prevention and cessation for oral health professionals. *Int Dent J.* 2010;60(1):3-6.
17. Hanioka T, Ojima M, Tanaka H, et al. Intensive smoking-cessation intervention in the dental setting. *J Dent Res.* 2010;89(1):66-70.
18. Vichitvejpaisal P, Joshi GP, Liu J, et al. Effect of severity of pulmonary disease on nitrous oxide washin and washout characteristics. *J Med Assoc Thai.* 1997;80(6):378-383.
19. Shakeri-Nejad K, Stahlmann R. Drug interactions during therapy with three major groups of antimicrobial agents. *Expert Opin Pharmacother.* 2006;7(6):639-651.
20. Peter KP, Mute BR, Doiphode SS, et al. Association between periodontal disease and chronic obstructive pulmonary disease: a reality or just a dogma? *J Periodontol.* 2013;84(12):1717-1723.
21. Scannapieco FA, Shay K. Oral health disparities in older adults: oral bacteria, inflammation, and aspiration pneumonia. *Dent Clin North Am.* 2014;58(4):771-782.
22. Kucukcoskun M, Baser U, Oztekin G, et al. Initial periodontal treatment for prevention of chronic obstructive pulmonary disease exacerbations. *J Periodontol.* 2013;84(7):863-870.
23. Brook U, Singer L, Fried D. Development of severe Stevens-Johnson syndrome after administration of slow-release theophylline. *Pediatr Dermatol.* 1989;6(2):126-129.
24. Barrios RJ, Kheradmand F, Batts L, et al. Asthma: pathology and pathophysiology. *Arch Pathol Lab Med.* 2006;130(4):447-451.
25. Centers for Disease Control and Prevention. Asthma. <http://www.cdc.gov/nchs/fastats/asthma.htm>. Accessed 24 February 2016.
26. Masoli M, Fabian D, Holt S, et al. The global burden of asthma: executive summary of the GINA Dissemination Committee report. *Allergy.* 2004;59(5):469-478.
27. Asher I, Pearce N. Global burden of asthma among children. *Int J Tuberc Lung Dis.* 2014;18(11):1269-1278.
28. Heraghty JL, Henderson AJ. Highlights in asthma 2005. *Arch Dis Child.* 2006;91(5):422-425.
29. Gibson PG, McDonald VM, Marks GB. Asthma in older adults. *Lancet.* 2010;376(9743):803-813.
30. McDaniel M, Paxson C, Waldfogel J. Racial disparities in childhood asthma in the United States: evidence from the National Health Interview Survey, 1997 to 2003. *Pediatrics.* 2006;117(5):e868-e877.
31. Centers for Disease Control and Prevention. Trends in Asthma Prevalence, Health Care Use, and Mortality in the United States, 2001–2010. NCHS Data Brief No. 94. (Available at): <http://www.cdc.gov/nchs/data/databriefs/db94.htm>. Accessed 24 February 2016.
32. Subbarao P, Mandhane PJ, Sears MR. Asthma: epidemiology, etiology and risk factors. *CMAJ.* 2009;181(9):E181-E190.
33. Barnes PJ. Molecular mechanisms of antiasthma therapy. *Ann Med.* 1995;27(5):531-535.
34. Murphy DM, O'Byrne PM. Recent advances in the pathophysiology of asthma. *Chest.* 2010;137(6):1417-1426.
35. Mathison DA, Stevenson DD, Simon RA. Precipitating factors in asthma. Aspirin, sulfites, and other drugs and chemicals. *Chest.* 1985;87(1 suppl):50S-54S.
36. Babu KS, Salvi SS. Aspirin and asthma. *Chest.* 2000;118(5):1470-1476.
37. United States Food and Drug Administration. Warning on prescription drugs containing sulfites. *FDA Drug Bul.* 1987;17:2-3.
38. Elward KS, Pollart SM. Medical therapy for asthma: updates from the NAEPP guidelines. *Am Fam Physician.* 2010;82(10):1242-1251.
39. Abba AA. Exhaled nitric oxide in diagnosis and management of respiratory diseases. *Ann Thorac Med.* 2009;4(4):173-181.
40. National Heart Lung and Blood Institute. Guidelines for the Diagnosis and Management of Asthma (EPR-3). Available at: <http://www.nhlbi.nih.gov/health-pro/guidelines/current/asthma-guidelines>. Accessed 24 February 2016.
41. Ernst P, Spitzer WO, Suissa S, et al. Risk of fatal and near-fatal asthma in relation to inhaled corticosteroid use. *JAMA.* 1992;268(24):3462-3464.
42. Rees J. Asthma control in adults. *BMJ.* 2006;332(7544):767-771.
43. Di Domenico M, Bisogno A, Polverino M, et al. Xolair in asthma therapy: an overview. *Inflamm Allergy Drug Targets.* 2011;10(1):2-12.
44. Suissa S, Ernst P. Albuterol in mild asthma. *N Engl J Med.* 1997;336(10):729. author reply 30.
45. Ulrik CS, Frederiksen J. Mortality and markers of risk of asthma death among 1,075 outpatients with asthma. *Chest.* 1995;108(1):10-15.
46. Mathew T, Casamassimo PS, Wilson S, et al. Effect of dental treatment on the lung function of children with asthma. *J Am Dent Assoc.* 1998;129(8):1120-1128.
47. Schwartz HJ, Gilbert IA, Lenner KA, et al. Metabisulfite sensitivity and local dental anesthesia. *Ann Allergy.* 1989;62(2):83-86.
48. Jamieson DM, Guill MF, Wray BB, et al. Metabisulfite sensitivity: case report and literature review. *Ann Allergy.* 1985;54(2):115-121.
49. Elnabity MH, Singh RF, Ansong MA, et al. Leukotriene modifiers in the management of asthma. *J Am Osteopath Assoc.* 1999;99(7 suppl):S1-S6.
50. del Giudice MM, Pezzulo A, Capristo C, et al. Leukotriene modifiers in the treatment of asthma in children. *Ther Adv Respir Dis.* 2009;3(5):245-251.
51. Lazarus SC. Clinical practice. Emergency treatment of asthma. *N Engl J Med.* 2010;363(8):755-764.
52. Bresolin D, Shapiro PA, Shapiro GG, et al. Mouth breathing in allergic children: its relationship to dentofacial development. *Am J Orthod.* 1983;83(4):334-340.

53. Visweswar VK, Amarlal D, Veerabahu R. Prevalence of developmental defects of enamel in children and adolescents with asthma: a cross-sectional study. *Indian J Dent Res.* 2012;23(5):697-698.
54. Gomes-Filho IS, Soledade-Marques KR, Seixas da Cruz S, et al. Does periodontal infection have an effect on severe asthma in adults? *J Periodontol.* 2014;85(6):e179-e187.
55. Kargul B, Tanboga I, Ergeneli S, et al. Inhaler medicament effects on saliva and plaque pH in asthmatic children. *J Clin Pediatr Dent.* 1998;22(2):137-140.
56. Ryberg M, Moller C, Ericson T. Saliva composition and caries development in asthmatic patients treated with beta 2-adrenoceptor agonists: a 4-year follow-up study. *Scand J Dent Res.* 1991;99(3):212-218.
57. Milano M, Lee JY, Donovan K, et al. A cross-sectional study of medication-related factors and caries experience in asthmatic children. *Pediatr Dent.* 2006;28(5):415-419.
58. Diagnostic Standards and Classification of Tuberculosis in Adults and Children. This official statement of the American Thoracic Society and the Centers for Disease Control and Prevention was adopted by the ATS Board of Directors, July 1999. This statement was endorsed by the Council of the Infectious Disease Society of America, September 1999. *Am J Respir Crit Care Med.* 2000;161(4 Pt 1):1376-1395.
59. Ellner J. Tuberculosis. In: Goldman L, Schafer A, eds. *Goldman-Cecil Medicine.* 25th ed. Philadelphia: Saunders/Elsevier; 2016:2030-2039.
60. Aziz MA, Wright A. The World Health Organization/International Union Against Tuberculosis and Lung Disease Global Project on Surveillance for Anti-Tuberculosis Drug Resistance: a model for other infectious diseases. *Clin Infect Dis.* 2005;41(suppl 4):S258-S262.
61. Cantwell MF, Snider DE Jr, Cauthen GM, et al. Epidemiology of tuberculosis in the United States, 1985 through 1992. *JAMA.* 1994;272(7):535-539.
62. Centers for Disease Control and Prevention. Tuberculosis: Data and Statistics. (Available at): <http://www.cdc.gov/tb/statistics/default.htm>. Accessed 24 February 2016.
63. Mancuso JD, Diffenderfer JM, Ghassemieh BJ, et al. The prevalence of latent tuberculosis infection in the United States. *Am J Respir Crit Care Med.* 2016.
64. Centers for Disease Control and Prevention. Tuberculosis Trends - United States, 2014. *Morbidity and Mortality Weekly Report.* 2015;64(10):265-269.
65. World Health Organization. Tuberculosis Fact Sheet. (Available at): <http://www.who.int/mediacentre/factsheets/fs104/en/>. Accessed 24 February 2016.
66. Jereb JA, Kelly GD, Dooley SW Jr, et al. Tuberculosis morbidity in the United States: final data, 1990. *MMWR CDC Surveill Summ.* 1991;40(3):23-27.
67. Horsburgh CR Jr, O'Donnell M, Chamblee S, et al. Revisiting rates of reactivation tuberculosis: a population-based approach. *Am J Respir Crit Care Med.* 2010;182(3):420-425.
68. Jung RS, Bennion JR, Sorvillo F, et al. Trends in tuberculosis mortality in the United States, 1990-2006: a population-based case-control study. *Public Health Rep.* 2010;125(3):389-397.
69. Weir MR, Thornton GF. Extrapulmonary tuberculosis. Experience of a community hospital and review of the literature. *Am J Med.* 1985;79(4):467-478.
70. Dinnes J, Deeks J, Kunst H, et al. A systematic review of rapid diagnostic tests for the detection of tuberculosis infection. *Health Technol Assess.* 2007;11(3):1-196.
71. Centers for Disease Control and Prevention. Tuberculosis Fact Sheets: Tuberculin Skin Testing. (Available at): <http://www.cdc.gov/tb/publications/factsheets/testing/skintesting.htm>. Accessed 24 February 2106.
72. Mazurek GH, Jereb J, Vernon A, et al. Updated guidelines for using Interferon Gamma Release Assays to detect *Mycobacterium tuberculosis* infection—United States, 2010. *MMWR Recomm Rep.* 2010;59(RR-5):1-25.
73. Holden M, Dubin MR, Diamond PH. Frequency of negative intermediate-strength tuberculin sensitivity in patients with active tuberculosis. *N Engl J Med.* 1971;285(27):1506-1509.
74. Centers for Disease Control and Prevention Division of Tuberculosis Elimination. Module 2: epidemiology of tuberculosis. In: *Self-Study Modules on Tuberculosis.* Atlanta: U.S. Department of Health and Human Services; 1995:1-5.
75. Centers for Disease Control and Prevention. Fact Sheet: Treatment Options for Latent Tuberculosis Infection. (Available at): <http://www.cdc.gov/tb/publications/factsheets/treatment/tbitreatmentoptions.htm>. Accessed 25 February 2016.
76. Florio S, Ellis E 3rd, Frost DE. Persistent submandibular swelling after tooth extraction. *J Oral Maxillofac Surg.* 1997;55(4):390-397.
77. Fair E, Hopewell PC, Pai M. International standards for tuberculosis care: revisiting the cornerstones of tuberculosis care and control. *Expert Rev Anti Infect Ther.* 2007;5(1):61-65.
78. Centers for Disease Control and Prevention. Treatment for TB Disease. (Available at): <http://www.cdc.gov/tb/topic/treatment/tbdisease.htm>. Accessed 24 February 2106.
79. Centers for Disease Control and Prevention. Bacteriologic conversion of sputum among tuberculosis patients—United States. *MMWR Morb Mortal Wkly Rep.* 1985;34(49):747-750.
80. Zou G, Wei X, Witter S, et al. Incremental cost-effectiveness of improving treatment results among migrant tuberculosis patients in Shanghai. *Int J Tuberc Lung Dis.* 2013;17(8):1056-1064.
81. Jensen PA, Lambert LA, Iademarco MF, et al. Guidelines for preventing the transmission of *Mycobacterium tuberculosis* in health-care settings, 2005. *MMWR Recomm Rep.* 2005;54(RR-17):1-141.
82. World Health Organization. Drug-Resistant TB: Surveillance & Response. 2014.
83. Wells CD. Global impact of multidrug-resistant pulmonary tuberculosis among HIV-infected and other immunocompromised hosts: epidemiology, diagnosis, and strategies for management. *Curr Infect Dis Rep.* 2010;12(3):192-197.
84. Centers for Disease Control and Prevention. TB Elimination: Extensively Drug-Resistant Tuberculosis.

- (Available at): <http://www.cdc.gov/tb/publications/factsheets/drtb/xdrtb.pdf>. Accessed 24 February 2016.
85. Taylor Z, Nolan CM, Blumberg HM, et al. Controlling tuberculosis in the United States. Recommendations from the American Thoracic Society, CDC, and the Infectious Diseases Society of America. *MMWR Recomm Rep*. 2005;54(RR-12):1-81.
 86. Bass JB Jr, Farer LS, Hopewell PC, et al. Treatment of tuberculosis and tuberculosis infection in adults and children. American Thoracic Society and The Centers for Disease Control and Prevention. *Am J Respir Crit Care Med*. 1994;149(5):1359-1374.
 87. Forget EJ, Menzies D. Adverse reactions to first-line antituberculosis drugs. *Expert Opin Drug Saf*. 2006;5(2):231-249.
 88. Kakisi OK, Kechagia AS, Kakisis IK, et al. Tuberculosis of the oral cavity: a systematic review. *Eur J Oral Sci*. 2010;118(2):103-109.
 89. Bhargava S, Watmough DJ, Chisti FA, et al. Case report: tuberculosis of the parotid gland—diagnosis by CT. *Br J Radiol*. 1996;69(828):1181-1183.
 90. Helbling CA, Lieger O, Smolka W, et al. Primary tuberculosis of the TMJ: presentation of a case and literature review. *Int J Oral Maxillofac Surg*. 2010;39(8):834-838.
 91. Institute of Medicine (US). Committee on regulating occupational exposure to tuberculosis. In: Field M, ed. *Tuberculosis in the Workplace*. Washington DC: National Academies Press; 2001.

Smoking and Tobacco Use Cessation

Tobacco use by smoking (cigarettes, cigars, pipes) or by smokeless products (chewing tobacco, snuff) is an addictive disease that continues to be a major public health problem. Smoking is the leading cause of preventable death and disease in the United States, resulting in nearly half a million premature deaths per year and more than \$200 billion in direct health care costs and lost productivity.¹⁻³ In addition, more than 8.6 million persons are disabled because of smoking-related diseases. Smoking causes more than twice as many deaths as human immunodeficiency virus (HIV) and acquired immunodeficiency syndrome (AIDS), alcohol abuse, motor vehicle crashes, illicit drug use, and suicide combined.¹⁻³ On average, smokers die 10 years earlier than nonsmokers.¹⁻³

The objectives of this chapter are to help readers understand the physical and psychological effects of smoking and tobacco usage and to understand the basic principles involved in a smoking cessation program and how they are used.

CRITICAL COMPLICATIONS: Patients who use tobacco are at high risk for complications such as lung disease, cancer, and infections, as well as complications of other systemic and oral diseases. These complications could prove serious. Dentists must be able to detect these patients based on history and clinical findings, refer them for medical diagnosis and management, and work closely with their physicians to develop dental management plans that will be effective and safe for these patients.

EPIDEMIOLOGY

It is estimated that approximately 20.6% (46 million) of adults older than the age of 18 years in the United States are current smokers and that of these, 78.1% (36.4 million) smoke every day (Table 8.1).¹⁻³ Thus, in a dental practice of 2000 patients, it can be expected that approximately 400 patients will be smokers. Over the past few decades, the percentage of daily smokers who smoked more than 25 cigarettes per day (CPD) (i.e., heavy smokers) has decreased steadily. Although this trend is encouraging, the problem continues to be a serious public health issue¹⁻³ (Fig. 8.1).

The prevalence of current cigarette smoking varies substantially across population subgroups.¹⁻³ Current smoking rates are higher among men (23.5%) than women

(17.9%). Among racial/ethnic populations, Asians (12%) and Hispanics (14.5%) have the lowest prevalence of current smoking; multiracial individuals have the highest (29.5%) followed by Native Americans/Native Alaskans (23.2%), non-Hispanic whites (22.1%), and non-Hispanic blacks (21.3%). By education level, current smoking is most prevalent among adults who have earned graduate educational development (GED) diplomas (49.1%) and lowest in those with graduate degrees (5.6%). Persons 65 years and older have the lowest prevalence of current cigarette smoking (9.5%) among all adults. Current smoking prevalence is higher among adults who live below the poverty level (31.1%) than among those at or above the poverty level (19.4%). Smoking prevalence also varies significantly by state and area, ranging from 9.8% in Utah to 25.6% in Kentucky and West Virginia¹⁻³ (Fig. 8.2).

The use of smokeless tobacco is primarily seen in men and adolescent boys who are rural residents of southern and western states, whites, Native Americans and Native Alaskans, and persons with lower levels of education.^{4,5} Prevalence is highest in Wyoming (9.1%), West Virginia (8.5%), and Mississippi (7.5%) and lowest in California (1.3%), the District of Columbia (1.5%), Massachusetts (1.5%), and Rhode Island (1.5%) (Fig. 8.3). The use of smokeless tobacco became a national public health issue in the early to mid-1980s, when tobacco companies aggressively marketed their products by targeting young people. This practice was halted as a result of Congressional legislation and resulted in a gradual decline in prevalence.^{4,5}

The economic impact of smoking is staggering. On a national level, the U.S. Public Health Service estimates a total annual cost of \$50 billion for the treatment of patients with smoking-related disease in addition to \$47 billion in lost wages and productivity. For the individual smoker, the economic impact of smoking can be substantial, especially given that many smokers have limited financial resources.^{4,5}

PATHOPHYSIOLOGY AND COMPLICATIONS

Smoking is a learned or conditioned behavior that is reinforced by nicotine.⁶ Cigarettes promote this conditioning because they allow precise dosing that can be repeated as often as necessary to avoid discomfort and produce maximal desired effects. In addition, smoking behavior

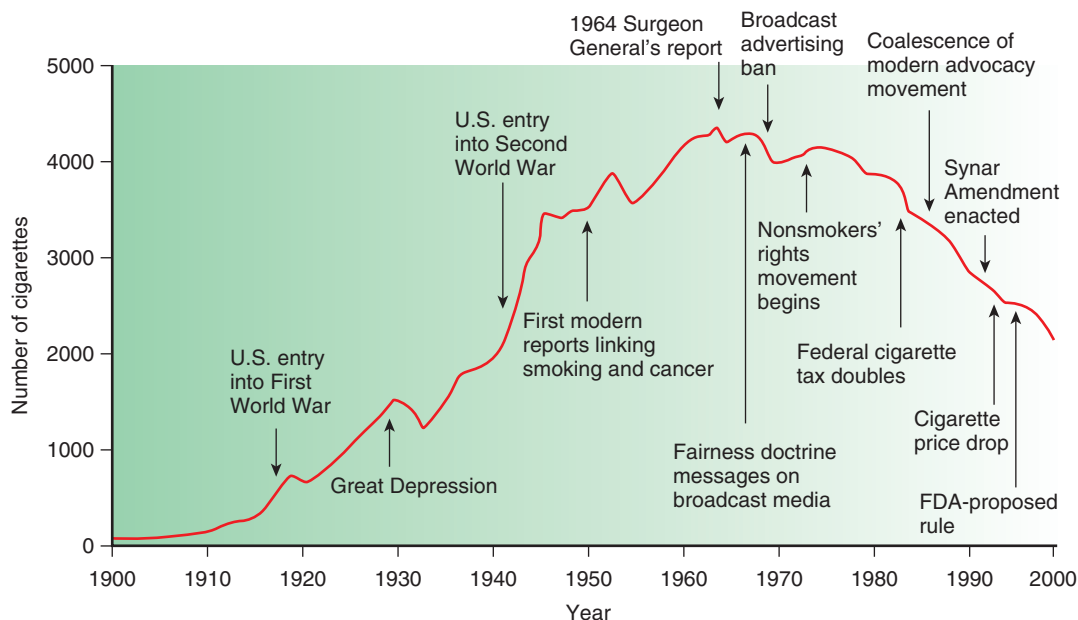

FIG 8.1 Decline of cigarette smoking in the United States over the period from 1900 to 2000. *FDA*, Food and Drug Administration.

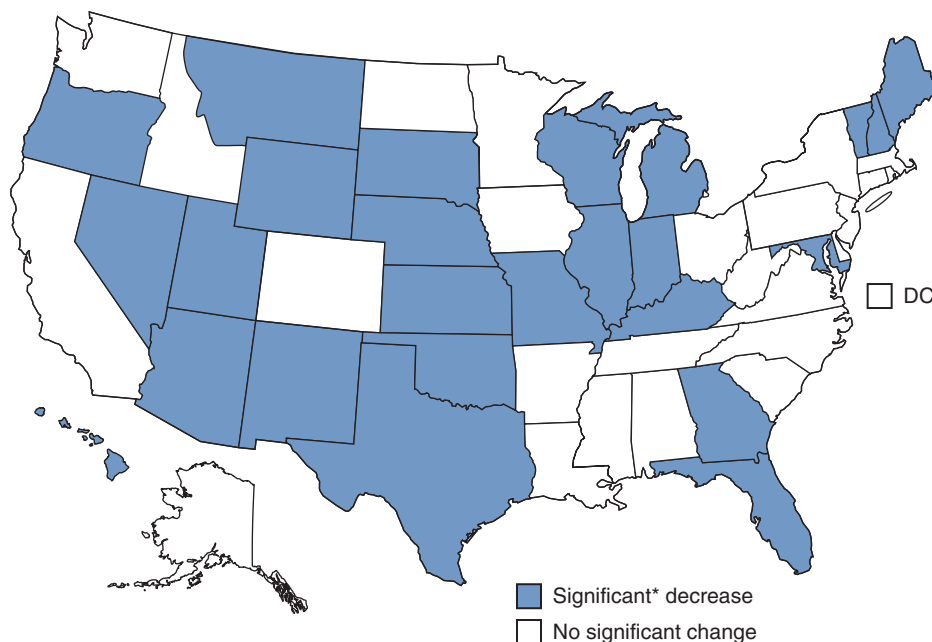

FIG 8.2 Changes in cigarette smoking in the United States by state. *Asterisk* indicates "significant change," which is defined as >5%.

TABLE 8.1 Annual Costs of Smoking

	\$4/pack	\$5/pack	\$6/pack
1 pack/day	\$1460	\$1825	\$2190
2 packs/day	\$2920	\$3350	\$4380
3 packs/day	\$4380	\$5475	\$6570

is reinforced by and associated with common daily events such as awakening, eating, and socializing. Thus, these associations become almost unavoidable parts of smokers' lives.

Nicotine is a highly addictive drug that has been equated with heroin, cocaine, and amphetamine in terms of addiction potential and its effects on brain neurochemistry.⁶⁻⁸ The addictive and behavioral effects of nicotine are complex and are due primarily to its effects on dopaminergic pathways. The physiologic and

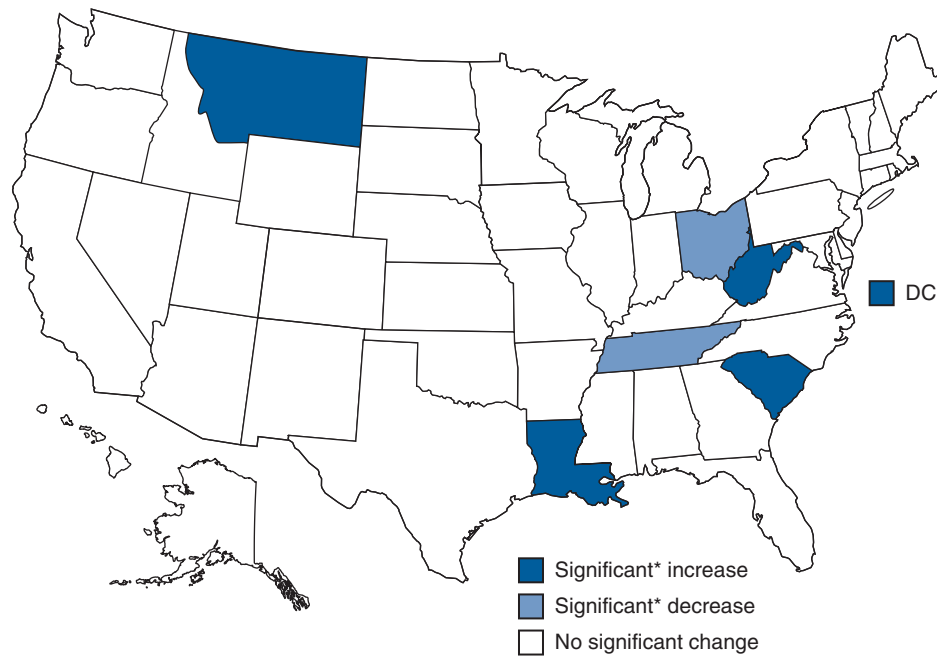

FIG 8.3 Changes in smokeless tobacco use in the United States by state. Asterisk indicates "significant change," which is defined as >5%.

behavioral effects of nicotine include increased heart rate, increased cardiac output, increased blood pressure, appetite suppression, a strong sense of pleasure and well-being, improved task performance, and reduced anxiety. Tolerance develops with repeated exposure so that, over time, it takes more and more nicotine to produce the same level of effect.⁶⁻⁸

Nicotine is absorbed through the skin and the mucosal lining of the nose and mouth and by inhalation in the lungs. A cigarette is a very efficient delivery system for the inhalation of nicotine. Nicotine is rapidly distributed throughout the body after inhalation, reaching the brain in as little as 10 seconds.

Mucosal absorption from smokeless tobacco is slower, but the effects are more sustained. Nicotine that is swallowed is not well absorbed in the stomach because of the acidic environment.

The effects of nicotine gradually diminish over 30 to 120 minutes; this produces withdrawal effects that may include agitation, restlessness, anxiety, difficulty concentrating, insomnia, hunger, and a craving for cigarettes. The elimination half-life of nicotine is about 2 hours, which allows it to accumulate with repeated exposure to cigarettes throughout the day, with effects persisting for hours.⁶⁻⁸

A typical smoker will take 10 puffs of every cigarette over a period of about 5 minutes that the cigarette is lit. Each cigarette delivers about 1 mg of nicotine. Thus, a person who smokes about 1½ packs (30 cigarettes) a day gets 300 hits of nicotine to the brain every day, each one within 10 seconds after a puff.⁶⁻⁸ This repeated reinforcement is a strong contributor to the highly addictive nature of nicotine.

Cigarette smoking is a major risk factor for stroke, myocardial infarction, peripheral vascular disease, aortic aneurysm, and sudden death. It is the leading cause of lung disease, including chronic obstructive pulmonary disease (COPD), pneumonia, and lung cancer.^{7,8} It is also strongly linked to cancers of the mouth, esophagus, stomach, pancreas, cervix, kidney, colon, and bladder. Other effects include premature skin aging and an increased risk for cataracts.^{7,8} Cigar and pipe smokers are subject to similar addictive and general health risks as are cigarette smokers, although pipe and cigar users typically do not inhale. Evidence suggests that smokeless tobacco use may be associated with adverse pregnancy outcomes and pancreatic cancer.^{2,5,9}

Health care professionals must be vigilant in identifying patients who use tobacco with the goals of encouraging them to stop smoking and assisting them in their efforts. Studies indicate that 70% of smokers want to quit smoking.¹⁰ However, for every smoker who successfully quits, many more do not succeed. Tobacco dependence is a chronic condition that often requires repeated attempts at intervention. Smokers typically fail multiple attempts to quit before they achieve success.

People who quit smoking live longer than those who continue to smoke because of avoiding the development of smoking-related fatal diseases.^{2,7,9} The extent to which a smoker's risk is reduced by quitting depends on several factors, including number of years as a smoker, number of cigarettes smoked per day, and presence or absence of disease at the time of quitting. Data show that persons who quit smoking before 50 years of age have half the risk of dying in the next 15 years compared with those who continue smoking. Risks of dying of lung cancer are

BOX 8.1 Benefits of Quitting Smoking According to the U.S. Surgeon General

- 20 minutes after quitting: Your heart rate drops. (U.S. Surgeon General's Report, 1988, pp 39, 202)
 - 12 hours after quitting: Carbon monoxide level in your blood drops to normal. (U.S. Surgeon General's Report, 1988, p 202)
 - 2 weeks to 3 months after quitting: Your circulation improves, and your lung function increases. (U.S. Surgeon General's Report, 1990, pp 193, 194, 196, 285, 323)
 - 1 to 9 months after quitting: Coughing and shortness of breath decrease; cilia (tiny hairlike structures that move mucus out of the lungs) regain normal function in the lungs, increasing the ability to handle mucus, clean the lungs, and reduce the risk of infection. (U.S. Surgeon General's Report, 1990, pp 285-287, 304)
 - 1 year after quitting: The excess risk of coronary heart disease is half that of a smoker's. (U.S. Surgeon General's Report, 1990, p vi)
 - 5 years after quitting: Your stroke risk is reduced to that of a nonsmoker 5 to 15 years after quitting. (U.S. Surgeon General's Report, 1990, p vi)
 - 10 years after quitting: The lung cancer death rate is about half that of a continuing smoker. Risks of cancer of the mouth, throat, esophagus, bladder, cervix, and pancreas decrease. (U.S. Surgeon General's Report, 1990, pp vi, 131, 148, 152, 155, 164, 166)
 - 15 years after quitting: The risk of coronary heart disease is that of a nonsmoker. (U.S. Surgeon General's Report, 1990, p vi)
- Quitting helps to stop the damaging effects of tobacco on your appearance, including the following:
- Premature wrinkling of the skin
 - Bad breath
 - Stained teeth
 - Gum disease
 - Bad-smelling clothes and hair
 - Yellow fingernails
 - Food tastes better
 - Sense of smell returns to normal
 - Ordinary activities (e.g., climbing stairs, light housework) no longer leave you out of breath

22 times higher among male smokers and 12 times higher among female smokers than in those who have never smoked. Smokers have twice the risk of dying of coronary heart disease as lifetime nonsmokers.^{2,7,9} Compared with lifetime nonsmokers, smokers have about twice the risk of dying from a stroke. Smoking increases the risk of COPD by accelerating the age-related decline in lung function. **Box 8.1** lists short- and long-term benefits of smoking cessation.

MEDICAL MANAGEMENT

Interventions for Smoking Cessation

Numerous ways have been devised to encourage and assist the cessation of smoking and tobacco use. Public health measures include raising awareness of the dangers of smoking and tobacco use by airing public service television

or radio ads, increasing the price of cigarettes and other tobacco products, and banning smoking in public places. Individual methods of smoking cessation include the use of telephone quit lines, nicotine replacement therapy (NRT), and medications, along with individual or group counseling.¹¹⁻¹⁶ Overall success rates for smoking cessation efforts are disappointingly low, and quitting is associated with high rates of relapse. The 1-year success rate for stopping “cold turkey” is about 5%. The use of telephone quit lines or brief counseling roughly doubles one's chance of success, as does the use of any of the NRT products.^{11,12} The 1-year success rate with bupropion is about 23%.¹⁷ Varenicline appears to be as effective as bupropion.¹³ NRT combined with bupropion improves the success rate to about 36%.¹⁶ It is interesting to note that one study reported that a program that used only intensive counseling reported a success rate of 68%.¹⁸ However, those participants already had COPD. In general, the chance for success increases when more than one option is used, and counseling combined with NRT or medication significantly improves outcomes.¹⁰

On an individual basis, health care providers should ask their patients about smoking or tobacco use at each appointment, advise current users to quit, and assist those who express an interest in quitting. In 2008, the U.S. Department of Health and Human Services, Public Health Service, published an update of the earlier 2000 Clinical Practice Guidelines for Treating Tobacco Use and Dependence¹⁰ to aid health care professionals in helping their patients to quit smoking. These guidelines are based on the **5 As**, which include *asking* patients about their tobacco use, *advising* those who use tobacco to quit, *assessing* the willingness of patients to make a quit attempt, *assisting* in the quit attempt, and *arranging* for follow-up. The effectiveness of the **5 As** initiative has been disappointing. Very few dentists or physicians are even aware of the **5 As**, much less follow them.^{19,20} Reasons most often cited by dentists for not incorporating smoking cessation services into their practices include time involved, lack of training, lack of adequate reimbursement, lack of knowledge of available referral sources, and lack of patient education materials. In view of the poor outcomes of the **5 As**, a suggested alternative approach is to *ask, advise, and then refer* (to an internal resource, an external resource, or a telephone quit line).^{19,20} This approach requires practitioners to be familiar with available referral sources.

DENTAL MANAGEMENT

It should be made clear to patients that the **dental office is a nonsmoking facility**. Signs should be posted that clearly state this. Dental health professionals should ask every patient about their use of tobacco. This can be easily accomplished by inclusion of tobacco use questions on the medical or dental history followed by a brief interview. For patients who are current tobacco users, additional questions, including the type of tobacco product

used, the frequency of use, and the length of time the product has been used, should be asked. Pipe and cigar users should be asked whether they inhale. During the oral mucosal examination, mucosal changes associated with tobacco use should be noted, and the patient should be advised of their presence and the association with tobacco use. Patients who use smokeless tobacco should be asked where they hold the tobacco in their mouth, and special attention should be paid to examination of that area. Any oral changes or systemic diseases that are present that may be related to tobacco use should be discussed and can be used as motivation to quit smoking. Patients should then be asked whether they have ever considered quitting and whether they would like to quit. They should be made aware that you support and encourage their quitting to improve their overall health and that you will assist them in their efforts to quit.

If a patient does not wish to quit, the health care provider is encouraged to point out the benefits of quitting as a potential method of motivating the patient. If there is resistance to intervention, the topic should be dropped and the patient not badgered. It is generally counterproductive to pursue the issue; however, patients can be told that, if at any time, they would like to quit, you would be happy to speak with them about it. They should then be asked at subsequent recall appointments whether they have given any more thought to quitting. If a patient indicates that he or she does wish to quit, the practitioner has several options:

- Help to coordinate a program for the patient or designate another individual (auxiliary) in the office to perform that function.
- Prescribe smoking cessation medications for the patient.
- Refer the patient to an outside smoking cessation program.
- Refer the patient to his or her primary care physician.
- Refer the patient to a counseling source, such as a telephone help line.

Depending on how involved the practitioner wishes to become, the following sections describe many options and resources that are available to assist patients in the effort to quit smoking.

Patient Education Literature

It is recommended that practitioners have patient education and motivational materials available for patients to read to encourage and support tobacco use cessation. Posters can be placed on the walls of the waiting room and treatment areas. Brochures may be kept in the waiting room and in treatment areas to be given to patients who express a desire to quit. Patient education materials are readily available from sources such as the American Cancer Society, the National Cancer Institute, and the U.S. Surgeon General. These can be ordered by phone or through their websites (Box 8.2). Brochures or handouts may be used

BOX 8.2 Resources for Support Material

Telephone Help and Quit Lines

- 800-QUITNOW (U.S. Department of Health and Human Services national quit line)
- 877-44-U-QUIT (National Cancer Institute dedicated quit smoking line)
- 877-YES-QUIT (American Cancer Society quit line)
- 800-4-CANCER (Cancer Information Service of the National Cancer Institute)

Helpful Websites

- www.surgeongeneral.gov/tobacco
- www.smokefree.gov
- www.nlm.nih.gov/medlineplus/smokingcessation.html
- www.cancer.gov/cancertopics/pdq/prevention/control-of-tobacco-use/HealthProfessional
- www.cdc.gov/tobacco
- www.cancer.org/docroot/PED/content/PED_10_13X_Guide_for_Quitting_Smoking.asp

to provide telephone quit line numbers or for referral to local smoking cessation programs or support groups. Practitioners also may wish to develop their own patient education materials.

Counseling

Even brief counseling, such as occurs when a health care professional routinely asks about smoking and encourages quitting, has been shown to increase quit success rates. Telephone counseling help lines (quit lines) have become widely available and have been shown to double success rates over those reported with quitting “cold turkey.” Help lines are available on national, regional, and state levels (see Box 8.2). Help lines provide the opportunity for the patient to speak to a counselor and can provide support for patients, regardless of whether they are considering quitting, attempting to quit, have successfully quit, or have relapsed. Group counseling can be especially effective by providing the social support and encouragement of the group. Counseling typically consists of both cognitive and behavioral therapies. Cognitive therapy attempts to change the way a patient thinks about smoking, and behavioral therapy attempts to help smokers avoid situations that might trigger the desire to smoke. Evidence has shown that the more intensive the counseling, the better the success rate and that when counseling is combined with other forms of therapy, such as NRT or pharmacotherapy, it is even more effective. Local, regional, and state health departments are additional sources for smoking cessation counseling.

Nicotine Replacement Therapy

The rationale for NRT is to replace cigarettes or smokeless tobacco with a source of nicotine that does not have the tars and carbon monoxide of tobacco and then to gradually reduce the use of that replacement product to the point

of abstinence.^{12,13,17,21-23} To prevent withdrawal symptoms, a smoker must maintain a baseline blood level of nicotine of about 15 to 18 ng/mL. A cigarette rapidly increases nicotine blood levels to 35 to 40 ng/mL, producing the “hit” or “rush” that a smoker experiences when smoking; this level then gradually returns to baseline within about 25 to 30 minutes. NRT attempts to provide a blood level that is adequate to prevent withdrawal symptoms without

producing the “hit” or “rush” caused by the cigarette. The patient then gradually learns to accept progressively lower and lower blood nicotine levels and then total abstinence.^{11-13,17,21} Five distinct nicotine replacement products are available that differ in cost, route of delivery, and efficiency of delivery of nicotine. These include the transdermal patch, gum, lozenges, the inhaler, and nasal spray (Table 8.2).

TABLE 8.2 Nicotine Replacement Products

Product	How Supplied	How Used	Adverse Effects	Advantages and Disadvantages
NICOTINE TRANSDERMAL PATCHES (OTC)				
Nicoderm CQ Nicorette Nicotrol, generic	Nicoderm CQ: 7, 14, 21 mg Nicorette: 5, 10, 15 mg Nicotrol: 5, 10, 15 mg	Start with patches of highest concentration; then use patches of progressively lower concentration over a 6- to 12-week period	Skin irritation, insomnia	Slow onset; takes 6–8 hours to reach peak blood level; cannot be readily titrated
NICOTINE GUM (OTC)				
Nicorette, generic	Available in strengths of 2 and 4 mg	Not to be chewed as normal gum; should be chewed slightly and then “parked” in the vestibule; repeat the chew–park sequence every 30 minutes; nicotine is absorbed through the mucosa; do not eat or drink for 15 minutes before using or while using; start with 8–24 pieces/day and gradually reduce over several weeks; maximum, 24/day	Mucosal irritation; indigestion	Quicker delivery than patch but not as quick as lozenge; produces less of a “rush” than is produced by cigarettes or lozenges
NICOTINE LOZENGES (OTC)				
Commit	Available in strengths of 2 and 4 mg	Strength required is determined by time to first cigarette in the morning; the lozenge is “parked” and moistened and allowed to dissolve in the mouth; start with 9–20/day and use progressively fewer per day over a 12-week period; do not eat or drink for 15 minutes before using or while using; maximum, 20/day	Gingival and throat irritation; indigestion	Peak blood levels in 20–30 minutes; 25% higher blood levels than gum; can be titrated as needed; very efficient; produces less of a rush than is caused by cigarettes but more of a rush than is produced by gum
NICOTINE NASAL SPRAY (PRESCRIPTION)				
Nicotrol NS	Supplied in a pump nasal spray bottle	One dose is a spray into each nostril; maximum of 40 doses per day is progressively decreased over 10–12 weeks	Nose and throat irritation	Fastest delivery system; provides the rush of cigarettes
NICOTINE INHALER (PRESCRIPTION)				
Nicotrol inhaler	Supplied as plastic cartridges; each cartridge provides 4 mg of nicotine (only 2 mg is absorbed)	Each inhaler contains 400 puffs; 80 puffs are equal to 1 cigarette; maximum, 16 cartridges/day; gradually decreased usage over several months	Mouth and throat irritation	Inefficient delivery system; expensive

OTC, Over the counter.

All of the NRT products have been approved by the U.S. Food and Drug Administration (FDA) for smoking cessation. They all appear to be effective when included as part of a program of smoking cessation, and they generally double the chances of success over quitting “cold turkey.”^{11-13,17,21-23} Selection of an NRT product should depend on the number of cigarettes smoked per day, its potential adverse effects, and patient preference. Generally, the more dependent the patient is on nicotine, the higher the beginning doses that will be required and the greater will be the need to titrate nicotine levels. For very dependent smokers, the combination of a patch with a shorter acting method such as gum, lozenge, or nasal spray may be indicated. The combination of NRT with counseling also improves chances for success.

Increasingly, the public is turning to electronic cigarettes (also called e-cigarettes or electronic nicotine delivery systems), which seem like a less harmful alternative to regular cigarettes. These “e-cigs” are devices that indeed still emit nicotine with flavorings and other chemicals to the “smoker.” The main difference is that the user is breathing in vapor instead of smoke.

E-cigarettes are designed to simulate the act of tobacco smoking by producing an appealingly flavored aerosol that looks and feels like tobacco smoke and delivers nicotine but with less of the toxic chemicals produced by burning tobacco leaves. Because they deliver nicotine without burning tobacco, e-cigarettes appear as if they may be a safer, less toxic alternative to conventional cigarettes.

Very often they resemble traditional tobacco cigarettes, cigars, or pipes. More than 250 different e-cigarette brands are currently on the market. Although e-cigarettes may be promoted and perceived as safer alternatives to traditional cigarettes, which deliver nicotine by burning tobacco, little is actually known yet about the health risks of using these devices. Most e-cigarettes consist of three different components, including:

- A cartridge, which holds a liquid solution containing varying amounts of nicotine, flavorings, and other chemicals
- A heating device (vaporizer)
- A power source (usually a battery)

With e-cigarettes, the resulting aerosol or vapor is then inhaled (called “vaping”).

Are e-cigarettes safer than conventional cigarettes? Unfortunately, this question is difficult to answer because insufficient information is available on these new products. A recent study²⁴ found that indeed these devices appear to be biologically harmful.

Additionally, the FDA has established a new rule for e-cigarettes and their liquid solutions in an effort to educate and inform users. Because e-cigarettes contain nicotine derived from tobacco, they are now subject to government regulation as tobacco products, including the requirement that both in-store and online purchasers be at least 18

years of age.²⁵ For more information about this FDA ruling, see the FDA.²⁶

Although they do not produce tobacco smoke, e-cigarettes still contain nicotine and other potentially harmful chemicals. Nicotine is a highly addictive drug, and recent research suggests nicotine exposure may also prime the brain to become addicted to other substances. Also, testing of some e-cigarette products found the vapor to contain known carcinogens and toxic chemicals (e.g., formaldehyde and acetaldehyde), as well as potentially toxic metal nanoparticles from the vaporizing mechanism. The health consequences of repeated exposure to these chemicals are not yet clear. For more information, see the National Institute on Drug Abuse.²⁷

Non-Nicotine Replacement Therapy Pharmacotherapy

Another first-line, FDA-approved, non-NRT pharmacotherapeutic cessation agent is bupropion SR, an atypical antidepressant that is thought to affect the dopaminergic or noradrenergic pathways (or both) involved in nicotine addiction.¹⁴⁻¹⁶ Bupropion is effective when used alone or in combination with an NRT product, counseling, or both. An attractive feature of bupropion is that it may prevent weight gain, which is a common adverse effect of smoking cessation. It is contraindicated in patients with seizure disorders and in those who might be prone to seizures. The most recently FDA-approved pharmacotherapeutic agent is varenicline (Chantix). This novel medication is an $\alpha_4\beta_2$ nicotinic receptor partial agonist that stimulates dopamine and blocks nicotinic receptors, thus preventing the reward and reinforcement associated with smoking.¹⁴⁻¹⁶ This medication should be started 3 days before the quit date and is taken for 12 weeks. It appears to be as effective as bupropion.¹³ Reports of depression and suicidal ideation have reported, resulting in a change in product labeling (Table 8.3). Glassman et al found that patients who stopped smoking often were quite depressed but responded to the use of clonidine.²³

Additional treatment strategies with less proven efficacy include the use of monoamine oxidase inhibitors, selective serotonin reuptake inhibitors, opioid receptor antagonists, bromocriptine, antianxiety drugs, nicotinic receptor antagonists, and glucose tablets. Various approaches under investigation include the use of partial nicotine agonists, anticonvulsants, inhibitors of the hepatic P-450 enzyme system, cannabinoid-1 receptor antagonists, and nicotine vaccines.¹⁵ Alternative or complementary approaches to smoking cessation have been advocated; however, because of the lack of evidence of effectiveness, their use cannot be supported at this time.²²

ORAL MANIFESTATIONS AND COMPLICATIONS

Tobacco use contributes to a number of oral diseases including halitosis, leukoplakia, squamous cell carcinoma,

TABLE 8.3 Non-Nicotine Replacement Therapy Pharmacotherapeutic Agents

Drug	Dosage	Adverse Effects	Precautions/Advantages
Bupropion SR (Zyban)	150 mg daily for 3 days; then 150 mg twice a day for 2–3 months; begin 1–2 weeks before quit date, and continue for at least 2–3 months	Dry mouth, insomnia	Contraindicated in patients with history of seizures or at risk for seizures; may prevent weight gain
Varenicline (Chantix)	Starting 1 week before quit date, 0.5 mg daily for 3 days; then 0.5 mg twice a day for 4 days; then 1.0 mg twice daily for 12 weeks	Nausea, insomnia, flatulence, headache; may cause mood changes, including depression and suicidal ideation	No clinically relevant drug interactions have been identified; may cause taste disturbance

NRT, Nicotine replacement therapy.

stomatitis, sialometaplasia, and periodontal disease. See Figs. 8.4 to 8.10.^{23,28-32}

Reports from the U.S. Surgeon General and others conclude that cigarette smoking is the main cause of cancer mortality in the United States, contributing to an estimated 30% of all cancer deaths and substantially to cancers of the head and neck.¹⁻⁴ The association between cigarette use and oral carcinoma has been firmly established from epidemiologic studies, revealing that there are more than twice as many smokers among oral cancer patients as among control populations.²⁸ One study found that 72% of more than 400 patients with oral cancer were smokers, and 58% smoked more than one pack daily (for many years), demonstrating the very high risk for tobacco users.²⁹

Tobacco use also increases the high risk for developing recurrences of oral cancer as well as second primary oral and pharyngeal cancers.^{23,28} The combined effects of tobacco and alcohol are illustrated in another study of more than 350 patients who had oral cancer and a mortality rate of 31% within 5 years.^{28,29}

Certain hydrocarbons isolated from tobacco products have been shown to induce carcinomas in animals under certain experimental conditions.^{28,29}

Benzo[a]pyrene, one of the most potent of these carcinogens, binds to nucleoproteins and is mutagenic as well as carcinogenic. The association between tobacco use and oral malignancies also appears to include cigars, pipes, and smokeless preparations^{28,29} (see Fig. 8.4). Tobacco use (both smoking and smokeless) has also been shown to increase periodontal disease, impair wound healing in the oral cavity, and increase the risk for implant failure.^{30,31}

Other adverse effects of smokeless tobacco aside from oral cancer include leukoplakia (see Fig. 8.5), nicotine stomatitis (see Fig. 8.6), smoker's melanosis, hairy tongue (see Fig. 8.7), snuff dipper's pouch (see Fig. 8.8), verrucous carcinoma (see Fig. 8.9), gingival recession (see Fig. 8.10), periodontitis, necrotizing ulcerative gingivitis (Fig. 8.11), and halitosis. Smokeless tobacco increases the risk of failure of intraosseous implants and the risk of dry socket, and it impairs wound healing. The sense of taste and smell is diminished as well.^{31,32}



FIG 8.4 Squamous cell carcinoma of the tongue in a heavy cigarette smoker.



FIG 8.5 Leukoplakia of the palate in a cigarette smoker.

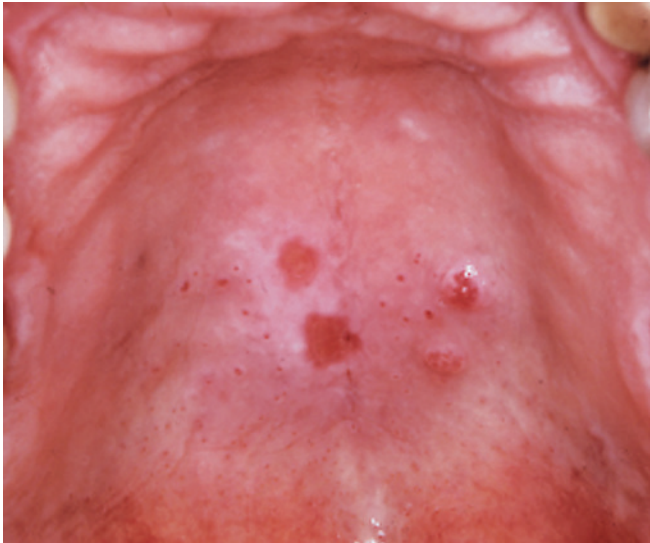

FIG 8.6 Severe nicotine stomatitis in a pipe smoker. Smoker's melanosis evident along the palatal vault.



FIG 8.7 Brown hairy tongue in a cigarette smoker.



FIG 8.8 Tobacco pouch in the vestibule of a tobacco chewer.



FIG 8.9 Verrucous carcinoma in a snuff user.



FIG 8.10 Gingival recession and leukoplakia in the area where snuff is held.



FIG 8.11 Necrotizing ulcerative gingivitis in a cigarette smoker.

REFERENCES

1. CDC. *National Cancer Institute. Current Cigarette Smoking Among Adults—U.S., 2005-2013*. Bethesda, MD: U.S. Department of Health and Human Services, National Cancer Institute; 2014. www.cdc.gov/mmwr/preview/mmwrhtml/mm6346a4.htm?s_cid=mm6347a4_w.
2. U.S. Department of Health and Human Services. *The Health Consequences of Smoking—50 Years of Progress: A Report of the Surgeon General*. Washington, DC: U.S. Department of Health and Human Services, CDC; 2014. <http://surgeongeneral.gov/library/reports/50yearsofprogress/full-report.pdf>.
3. CDC. *National Cancer Institute. State-Specific Prevalence of Current Cigarette Smoking and Smokeless Tobacco Use Among Adults Aged >18 Years—U.S., 2011-2013*. Bethesda, MD: U.S. Department of Health and Human Services, National Cancer Institute; 2014. www.cdc.gov/mmwr/preview/mmwrhtml/mm6419a6.htm?s_cid=mm6419a6_e.
4. CDC. *National Cancer Institute. Smokeless Tobacco and Public Health: A Global Perspective*. Bethesda, MD: U.S. Department of Health and Human Services, National Cancer Institute; 2014. www.cdc.gov/mmwr/preview/mmwrhtml/mm6419a6.htm?s_cid=mm6419a6_e.
5. National Cancer Institute. Tobacco and public health. pdf; 2014. http://cancercontrol.cancer.gov/brp/tcrb/global_perspective?smokeless.
6. Benowitz NL. Neurobiology of nicotine addiction: implications for smoking cessation treatment. *Am J Med*. 2008;121(4 suppl 1):S3-S10.
7. Jha P, Evans DB, Mills A, et al. Tobacco addiction. In: Jamison DT, et al, eds. *Disease Control Priorities in Developing Countries*. 2nd ed. Washington DC.: World Bank; 2013.
8. Niewoehner DE. Chronic obstructive pulmonary disease. Emphysema. Chapter 88. In: Goldman L, Schafer AI, eds. *Cecil Textbook of Medicine*. 25th ed. Elsevier; 2016:537-553.
9. Alguacil J, Silverman D. Smokeless and other noncigarette use and pancreatic cancer: a case-control study based on direct interviews. *Cancer Epidemiol Biomarkers Prev*. 2004;13:55-58.
10. Fiore MC, Jaen CR, Baker TB. *Treating Tobacco Use and Dependence: 2008 Update. Clinical Practice Guideline*. Rockville, MD: U.S. Department of Health and Human Services. Public Health Service; 2008.
11. Cooper TM, Clayton RR. *The Cooper/Clayton Method to Stop Smoking*. Lexington, KY: Institute for Comprehensive Behavioral Smoking Cessation; 2004.
12. Silagy C, Lancaster T, Stead L, et al. Nicotine replacement therapy for smoking cessation. *Cochrane Database Syst Rev*. 2004;(3):CD000146.
13. Cahill K, Stead LF, Lancaster T. Nicotine receptor partial agonists for smoking cessation. *Cochrane Database Syst Rev*. 2010;(12):CD006103.
14. Corelli RL, Hudmon KS. Pharmacologic interventions for smoking cessation. *Crit Care Nurs Clin North Am*. 2006;18(1):39-51, xii.
15. Frishman WH, Mitta W, Kupersmith A, et al. Nicotine and non-nicotine smoking cessation pharmacotherapies. *Cardiol Rev*. 2006;14(2):57-73.
16. Jorenby DE, Leischow SJ, Nides MA, et al. A controlled trial of sustained-release bupropion, a nicotine patch, or both for smoking cessation. *N Engl J Med*. 1999;340(9):685-691.
17. Hurt RD, Sachs DP, Glover ED, et al. A comparison of sustained-release bupropion and placebo for smoking cessation. *N Engl J Med*. 1997;337(17):1195-1202.
18. Willemsse B, Lesman-Leegte I, Timens W, et al. High cessation rates of cigarette smoking in subjects with and without COPD. *Chest*. 2005;128(5):3685-3687.
19. Hu S, Pallonen U, McAlister AL, et al. Knowing how to help tobacco users. Dentists' familiarity and compliance with the clinical practice guideline. *J Am Dent Assoc*. 2006;137(2):170-179.
20. Schroeder SA. What to do with a patient who smokes. *JAMA*. 2005;294(4):482-487.
21. CDC. *Best Practices for Comprehensive Control Programs—2014*. Atlanta, GA.: U.S. Department of Health and Human Services. CDC; 2014. www.cdc.gov/tobacco/standcommunity/bestpractices/pdfs/2014/comprehensive.pdf.
22. Dean AJ. Natural and complementary therapies for substance use disorders. *Curr Opin Psychiatry*. 2005;18(3):271-276.
23. Glassman A, Hughes JR. Clonidine, depression, and smoking cessation. *JAMA*. 1988;259(19):2901-2902. doi:10.1001/jama.1988.03720190069036.
24. Ji EH, Sun B, Zhao T, et al. Characterization of electronic cigarette aerosol and its induction of oxidative stress response in oral keratinocytes. *PLoS ONE*. 2016;11(5):e0154447. doi:10.1371/journal.<http://www.medscape.com/viewarticle/866195/2016>.
25. Bunnell RE, Israel T, Agaku IT, et al. Intentions to smoke cigarettes among never-smoking US middle and high school electronic cigarette users: national youth tobacco survey, 2011–2013. *Nicotine Tob Res*. 2015;17(2):228-235, Published online 2014 Aug 20. doi:10.1093/ntr/ntu166.
26. U.S. Food and Drug Administration. FDA takes significant steps to protect Americans from dangers of tobacco through new regulation, May 5, 2016. <http://www.fda.gov/NewsEvents/Newsroom/PressAnnouncements/ucm499234.htm>.
27. National Institute on Drug Abuse. Electronic cigarettes (e-cigarettes). <https://www.drugabuse.gov/publications/drugfacts/electronic-cigarettes-e-cigarettes>.
28. Rhodus NL, Kerr AR, Patel K. Oral cancer: leukoplakia and squamous cell carcinoma. *Dent Clin North Am*. 2014;58(2):315-340.
29. Silverman S. Chapter 2: etiology and predisposing factors in oral cancer. In: *American Cancer Society*. 6th ed. Publ. St. Louis: BC Decker; 2006:7-21.
30. Bergstrom J. Tobacco use and chronic destructive periodontal disease. *Odontology*. 2008;92:1-8.
31. Anner R, Grossmann Y, Anner Y, et al. Smoking, diabetes mellitus, periodontitis, and supportive periodontal treatment as factors associated with dental implant survival: a long-term retrospective evaluation of patients followed for up to 10 years. *Implant Dent*. 2010;19(1):57-64.
32. England L, Levine RJ, Mills JL, et al. Adverse pregnancy outcomes in snuff users. *Am J Obstet Gynecol*. 2003;189:939-943.

Sleep-Related Breathing Disorders

SNORING AND OBSTRUCTIVE SLEEP APNEA

DEFINITION

Sleep-related breathing disorders constitute a spectrum of clinical entities with variations in sleep structure, respiration, and blood oxygen saturation. The spectrum ranges from mild snoring to severe obstructive sleep apnea (OSA) (Fig. 9.1). Obesity-hypoventilation syndrome (formerly called Pickwickian syndrome) is the term used to describe a syndrome characterized by severe obesity, daytime hypoventilation, and sleep-disordered breathing.¹

Snoring, upper airway resistance syndrome (UARS), and OSA are the main subjects of this chapter. All of these sleep-related breathing disorders are caused by upper airway obstruction of variable degree, leading to resistance to airflow during respiration. Attempts to breathe continue despite the obstruction. A related disorder, central sleep apnea, is the cessation of breathing that is caused by disruption of central nervous system (CNS) ventilatory drive; this type of apnea usually is associated with an underlying medical problem such as heart failure² and is not caused by obstruction, so it is not included in this chapter.

Snoring may occur alone or may be caused by a more significant airway impairment. Snoring is the result of vibration of the soft tissues of the upper airway, primarily during inspiration. Primary snoring is sometimes referred to as simple snoring or benign snoring. It occurs as an independent entity and is not associated with disrupted sleep or complaints of daytime sleepiness and occurs without abnormal ventilation. Findings on an overnight sleep study, or polysomnogram (PSG), are normal. UARS is a clinical entity midway between primary snoring and OSA that is characterized by snoring, variable complaints of daytime sleepiness, and fragmentation of sleep. In UARS, a PSG typically demonstrates only a modest increase in ventilatory efforts, but the impairment is not severe enough to be classified as OSA. OSA, in contrast, is characterized by loud snoring and excessive daytime sleepiness with episodes of complete cessation of breathing (apnea) or significantly decreased ventilation (hypopnea) caused by airway obstruction during sleep along with significant fragmentation of sleep architecture. A PSG demonstrates significant abnormalities in sleep architecture, ventilation, and blood oxygen saturation.

COMPLICATIONS: Fragmented sleep leads to sleepiness, decreased alertness, irritability, poor concentration, lack of libido and memory loss. These can lead to poor job performance, marital discord, and driving impairment. The cardiovascular effects can result in hypertension, increased risk of stroke, congestive heart failure, pulmonary hypertension, cardiac arrhythmias, and death.

To appreciate the consequences of sleep-related breathing disorders, it is necessary to understand the aspects of normal sleep. Normal sleep patterns vary with age but are nevertheless similar across patient groups; thus, for illustrative purposes, the sleep of young adults is discussed here. Normal sleep occurs in two phases: non-rapid eye movement (NREM) sleep and rapid eye movement (REM) sleep³ (Table 9.1).

The phases of sleep are characterized by distinctive patterns on the electroencephalogram (EEG), as well as by the presence or absence of eye movements. NREM sleep occurs in three (or four) stages and generally is characterized by synchronous and increasingly high-amplitude, lower frequency brain waves, mental inactivity, and physiologic stability (Fig. 9.2). The NREM sleep state sometimes is referred to as “a quiet brain in a quiet body.” Stage 1 NREM is a brief, transitional stage that lasts only a few minutes between wakefulness and sleep and from which the person can be easily aroused. Stage 2 NREM is the initial stage of true sleep, from which arousal is more difficult. The appearance of EEG waves called *sleep spindles*, or *K-complexes*, identifies this stage, which typically lasts 10 to 25 minutes. Stage 3 is characterized by the appearance on the EEG of high-voltage, high-amplitude slow waves that last for a few minutes and then undergo transition into stage 4, with more frequent and higher amplitude slow waves. This stage lasts for 20 to 40 minutes. Stages 3 and 4 often are combined, and this combination is referred to as slow-wave sleep (SWS).

After a period of NREM sleep, a “lightening” or change occurs, marked by entry into REM sleep. REM sleep is very different from NREM sleep and is characterized by asynchronous, low-amplitude, high-frequency brain waves, an active brain, physiologic instability, and muscular inactivity. REM sleep state often is described as “an active brain in a paralyzed body.” A key feature is the presence of periodic rapid movement of the eyes with low-voltage EEG waves resembling those typical of wakefulness

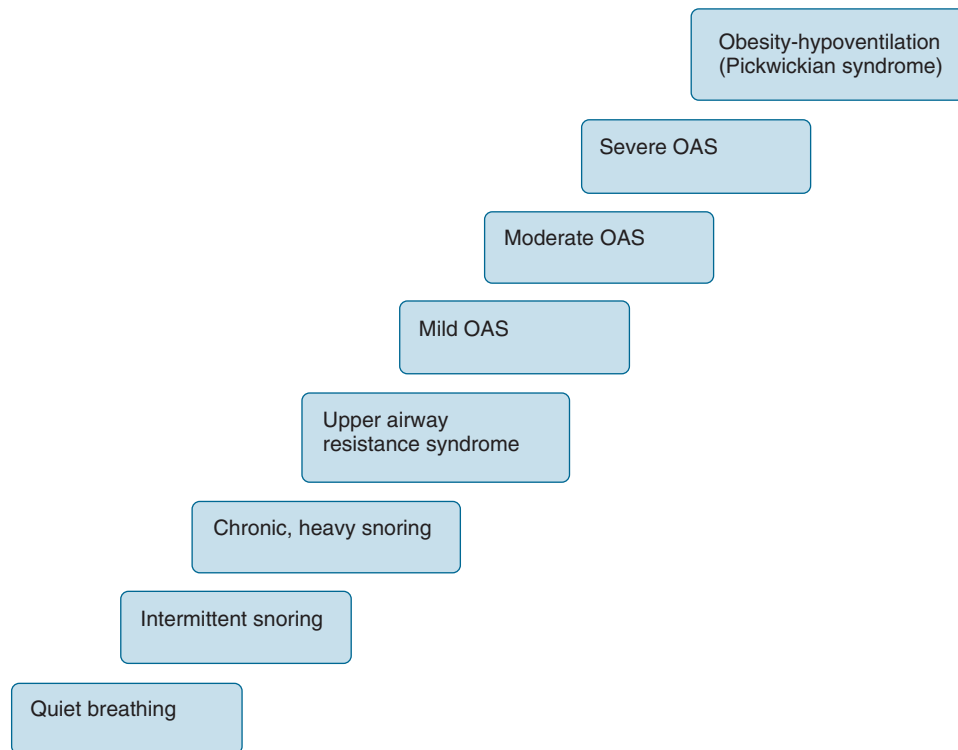

FIG 9.1 Clinical spectrum of sleep-related breathing disorders. OSAS, Obstructive sleep apnea syndrome. (Redrawn from Phillips B, Naughton MT: *Fast facts: obstructive sleep apnea*, Oxford, 2004, Health Press Limited.)

TABLE 9.1 Percentage of Time Spent in the Various Stages of Sleep for Normal, Healthy Young Adults

Stage Plus EEG Characteristics	Percent of Sleep (%)
Relaxed wakefulness	<5
Non-rapid eye movement sleep (NREM)	
Stage 1: transitional; easy arousal	2–5
Stage 2: sleep onset; K-complexes (sleep spindles)	45–55
Stage 3: high-voltage, high-amplitude slow waves	3–8
Stage 4: increased numbers of high-voltage slow waves	10–15
Rapid eye movement sleep (REM)	20–25
Associated with desynchronized brain waves on EEG, muscle atonia, bursts of rapid eye movement	

EEG, Electroencephalogram.

(Fig. 9.3). Variations in blood pressure, heart rate, and respiration occur, along with general muscle atonia and poikilothermia. Dreaming also occurs during REM sleep. Sleep normally is entered through NREM sleep and progresses to REM. Over the course of a night, sleep cycles between NREM and REM sleep, with each complete cycle

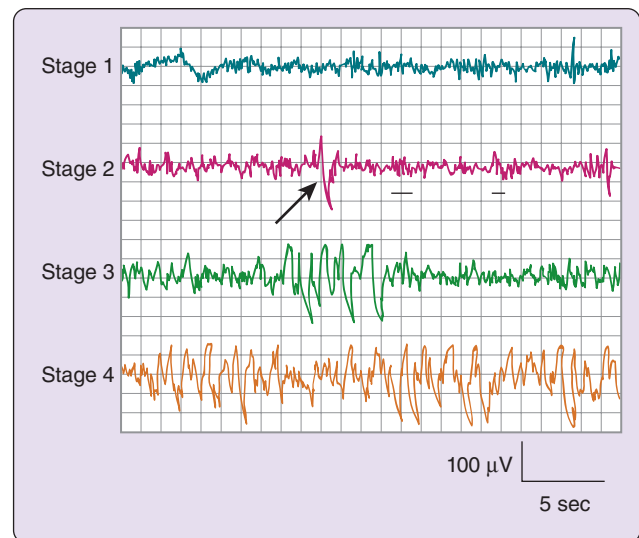

FIG 9.2 Electroencephalographic tracings of non-rapid eye movement sleep stages. (From Carskadon MA, Dement WC: Normal human sleep: an overview. In Kryger MH, Roth T, Dement WC, editors: *Principles and practice of sleep medicine*, ed 5, St. Louis, 2011, Saunders.)

(NREM + REM) averaging about 90 minutes. Depending on the length of the sleep period, the sleeper typically passes through four to six cycles per night. The length of time in each stage varies, with NREM predominating in the earlier part of the night and REM predominating

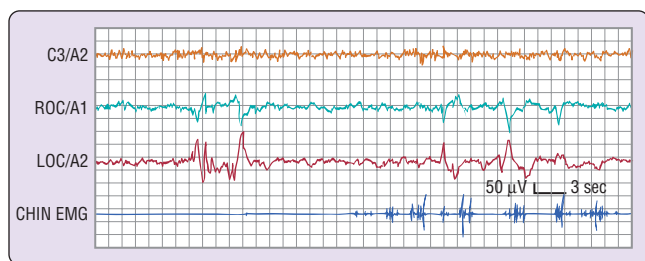

FIG 9.3 Phasic events in human rapid eye movement (REM) sleep. C3/A2 is an electrooculographic (EOG) lead. ROC/A1 is a lead from the outer canthus of the right eye, and LOC/A2 is another lead from the outer canthus of the left eye. Note the several bursts of activity in the eye lead tracings. (From Carskadon MA, Dement WC: Normal human sleep: an overview. In Kryger MH, Roth T, Dement WC, editors: *Principles and practice of sleep medicine*, ed 5, St. Louis, 2011, Saunders.)

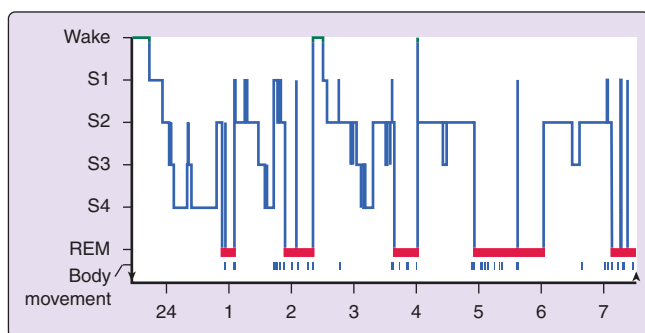

FIG 9.4 Histogram showing progression of sleep stages across a single night in a normal, healthy, young adult volunteer. REM, Rapid eye movement. (From Carskadon MA, Dement WC: Normal human sleep: an overview. In Kryger MH, Roth T, Dement WC, editors: *Principles and practice of sleep medicine*, ed 5, St. Louis, 2011, Saunders.)

in the later part of the night (Fig. 9.4). It is difficult to define a “normal” length of sleep because of multiple variables, including age, environment, circadian rhythm, and medication effects; however, most young adults report that they sleep an average of 7.5 hours per weeknight and 8.5 hours on weekend nights.^{4,5}

To gain the restorative benefits of sleep, it is necessary to progress through the normal stages of sleep. Whereas NREM sleep provides *physical* restoration, REM sleep provides *psychic* restoration. If such restoration does not occur because of sleep disruption or sleep fragmentation, cognitive and physiologic disturbances will result. Across the spectrum of sleep-related breathing disorders, different physiologic outcomes may be seen. With *primary snoring*, the degree of airway resistance is such that vibration of the parapharyngeal soft tissues is the only result. No sleep fragmentation or disruption occurs, and no other impairment of airflow or oxygenation is noted. Generally accepted thought has been that primary snoring has no significant adverse health effects, but evidence now suggests

that primary snoring may be a risk factor for type 2 diabetes, hypertension, carotid atherosclerosis, and stroke.⁶

With OSA, increasing resistance to airflow occurs as a result of partial (hypopnea) collapse or complete (apnea) collapse of the airway with the cessation of breathing despite continuing efforts to breathe. Depending on the degree and duration of the collapse, hypoxia, anoxia, and hypercarbia may occur. These changes lead to CNS arousal and transition to a lighter stage of sleep (stage 1 or 2), stimulating partial awakening, relief of the obstruction, and resumption of breathing. Depending on the frequency and duration of arousals during the night, sleep can be fragmented (Fig. 9.5). Sleep quality is poor, and the restorative benefits of sleep are not achieved, leading to a variety of cognitive and physiologic abnormalities.

Neurocognitive effects of OSA include sleepiness, decreased alertness, irritability, poor concentration, lack of libido, and memory loss. These deficits can lead to poor job performance, marital discord, interpersonal conflicts, and driving impairment. Up to 30% of traffic accidents involve sleepy drivers.⁷ A systematic review investigating the relationship of crash risk and OSA found that drivers with OSA have a mean crash risk-to-OSA ratio of between 1.21 and 4.89.⁸

In addition to neurocognitive impairment, OSA is associated with numerous cardiovascular effects, including hypertension, stroke, congestive heart failure, pulmonary hypertension, and cardiac arrhythmia. OSA, which is now recognized as one of the treatable causes of hypertension,⁹ also has been shown to significantly increase the risk of stroke and death.¹⁰ Patients with OSA have two- to fourfold greater odds of experiencing complex arrhythmias over those without the sleep disorder.¹¹ It also is thought that treatment of OSA may increase the survival rate among patients with heart failure.¹² In addition, a relationship between OSA, obesity, and metabolic syndrome has been noted. Recent data from the Sleep Heart Health Study provide evidence for an independent relationship among sleep apnea, glucose intolerance, and insulin resistance that may lead to type 2 diabetes.¹³ Overall, the mortality rate from all causes is significantly increased among people with untreated OSA and is proportional to the severity.¹⁴

EPIDEMIOLOGY

Snoring is extremely common in both genders and in all age groups. It is reported to occur in nearly 50% of the adult population, with a higher prevalence among men.¹⁵ Estimates of its prevalence vary widely because detection methods rely heavily on subjective reports by bed partners or parents. Reported prevalence rates for snoring range between 5% and 86% in men and between 2% and 57% in women.¹⁶ Evidence suggests that the frequency of snoring increases with age until about age 60 years, at which time a decrease occurs.¹⁵ In children, snoring is common, with a reported prevalence of 10%.¹⁷ It typically

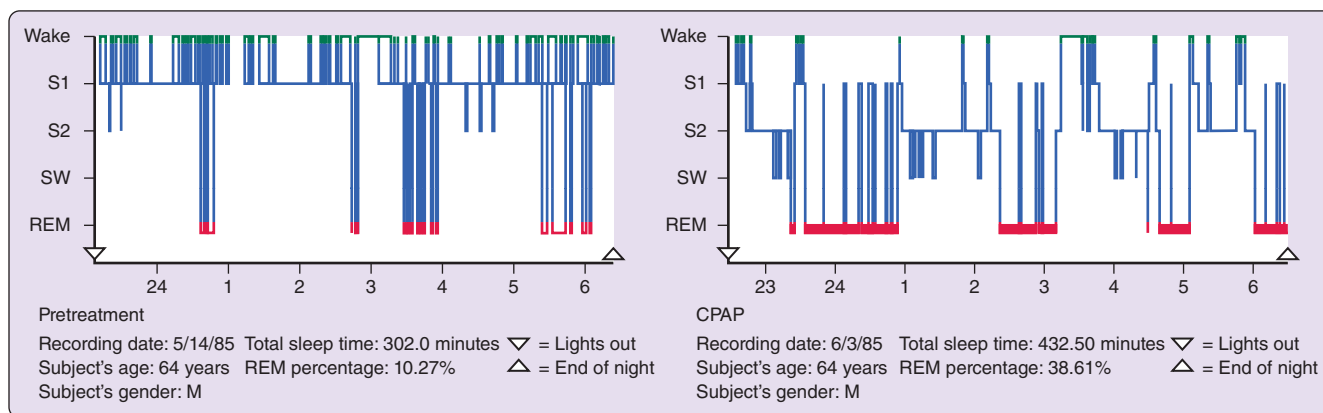

FIG 9.5 These sleep histograms show sleep study data for a 64-year-old male patient with obstructive sleep apnea syndrome. The *left graph* shows the sleep pattern before treatment. Note the absence of slow wave sleep (SWS), the preponderance of stage 1 (S1), and the very frequent disruptions. The *right graph* shows the sleep pattern in this patient during the second night of treatment with continuous positive airway pressure (CPAP). Note that sleep is much deeper (with more SWS) and more consolidated, and rapid eye movement (REM) sleep in particular is abnormally increased. The pretreatment REM percentage of sleep was only 10% versus nearly 40% with treatment. (From Carskadon MA, Dement WC: Normal human sleep: an overview. In Kryger MH, Roth T, Dement WC, editors: *Principles and practice of sleep medicine*, ed 5, St. Louis, 2011, Saunders.)

is associated with enlarged tonsils and adenoids, as well as obesity. Snoring also has been reported to increase markedly during pregnancy.¹⁸

The reported prevalence of OSA varies primarily because of differences in assessment methods and in the number of abnormal respiratory events per hour used to define abnormality. It is estimated that about 2% to 4% of the adult population 30 to 60 years of age is affected by OSA; however, 9% of women and 24% of men have signs or symptoms suggestive of sleep-disordered breathing.¹⁹ Different rates of occurrence have been reported for males and for females, with males affected more often. Variation among racial groups may be due to genetic differences. African Americans, Hispanics, and Asian Americans tend to have a somewhat higher prevalence than whites. About 3% of children are affected with OSA, with the highest prevalence reported between the ages of 2 and 5 years.²⁰

ETIOLOGY AND PATHOPHYSIOLOGY

The underlying defect in sleep-related breathing disorders is an anatomically narrowed upper airway combined with pharyngeal dilator muscle collapsibility. The exact pathogenesis, however, is not well understood. Depending on the extent of narrowing, increased resistance to airflow may be clinically expressed as vibration of soft tissues (snoring), reduced ventilation (hypopnea), or complete obstruction (apnea).

Anatomic narrowing may occur at any site in the upper airway from the nasal cavity to the larynx. Within the nasal cavity, septal deviation and enlarged turbinates may

cause narrowing. In the nasopharynx, hypertrophic adenoids and tonsils, an elongated soft palate, and an elongated and edematous uvula may be the cause. In the oropharynx, narrowing may be caused by an enlarged tongue, retrognathia, excessive lymphoid tissue, palatine tonsils, or redundant parapharyngeal folds. The most common sites of airway narrowing or closure during sleep are the retropalatal and retroglossal regions.²¹ Most patients with OSA have more than one site of narrowing. It also has been demonstrated that the volume of the upper airway soft tissue structures (i.e., tongue, lateral pharyngeal walls, soft palate, parapharyngeal fat pads) is significantly greater in patients with OSA than in normal control participants.²² Factors that are thought to contribute to enlargement of the upper airway soft tissues in apneic patients include obesity, edema secondary to negative pressures, vibration trauma of the uvula, male gender, and possibly genetics.²¹ Other anatomic risk factors for narrowing of the upper airway include retrognathia; a large tongue; a long soft palate; and enlarged uvula, tonsils, and adenoids.

In addition to anatomic narrowing of the airway, an abnormal degree of collapsibility is observed in the pharyngeal dilator muscles surrounding the airway. Patency of the airway depends on a balance between air pressure within the airway and pressure outside of the airway exerted by the parapharyngeal musculature. Muscles that surround the airway receive phasic activation during inspiration and tend to promote a patent pharyngeal lumen by dilating the airway and stiffening the airway walls.²³ Normally, the intraluminal pressure exceeds the external pressure, and the airway remains patent during inhalation

and exhalation. Normal function requires coordinated timing and activity of agonists and antagonists and of individual muscles or groups of muscles. The cause of abnormal pharyngeal airway collapse is complex, involving both dynamic and static factors. These factors may include tissue volume, changes in the adhesive character of mucosal surfaces, changes in neck and jaw posture, decreased tracheal tug, effects of gravity, autonomic and catecholamine dysfunction, and decreased intraluminal pressure resulting from increased upstream resistance in the nasal cavity or pharynx.^{21,24,25}

CLINICAL PRESENTATION

Signs and Symptoms

The signs and symptoms of sleep-related breathing disorders are those most often described by the bed partner or parent of a patient; they include snoring, snorting, gasping, and breath holding. Snoring is very common, as was previously indicated, and is the most common symptom in patients with OSA. However, most people who snore do not have OSA, but almost all patients with OSA snore. In the Wisconsin Sleep Cohort Study of participants aged 30 to 60 years, 44% of men and 28% of women were habitual snorers, but only 4% of the men and 2% of the women had OSA.²⁶

Snoring may be very loud and disruptive to other members of the household. When snoring is the only complaint, the problem most often is primary snoring. If snoring is accompanied by daytime sleepiness with no breathing changes during sleep, UARS must be considered. Snoring accompanied by snorting, choking, gasping, or a complete cessation of breathing is likely to be a sign of OSA. Of note, however, definitive diagnosis of sleep-related breathing disorders cannot be made on the basis of clinical signs and symptoms alone.

Complaints of excessive daytime sleepiness are common in patients with OSA but are not specific, and the problem may be multifactorial. A commonly used subjective measure of sleepiness is the Epworth Sleepiness Scale²⁷ (Fig. 9.6). This assessment tool has been validated in clinical studies and correlates with objective measures of sleepiness. It is composed of eight questions or situations in which patients are asked how likely they are to fall asleep. Each question is answered on a scale of 0 to 3, with 0 meaning no likelihood of falling asleep and 3 indicating 100% likelihood of falling asleep in that situation. The maximum possible score is 24. A score greater than 10 is indicative of significant daytime sleepiness but is not specific for sleep-related breathing disorders. Other complaints that may be associated with OSA are nocturia or enuresis, mood changes, memory or learning difficulties, erectile dysfunction, morning headache, and dry mouth noted upon awakening.

Obesity is common among patients with OSA and increases the risk of OSA severalfold. Approximately 70% of patients with OSA are obese.²⁸ One measure of obesity

is the body mass index (BMI), which is calculated by dividing weight in kilograms by the height in meters squared. Adults with BMIs greater than 25 are considered overweight, and those with BMIs over 30 are considered to be obese. Of interest, however, is that neck circumference has been found to be more closely related to severity of OSA than is BMI.²⁹ A neck circumference greater than 17 inches (43 cm) in men and greater than 16 inches (41 cm) in women is predictive of OSA.³⁰ In summary, the most useful predictors of OSA are witnessed apneas; excessive daytime sleepiness; male gender; BMI above 30; and neck circumference greater than 17 and 16 inches, respectively, for men and women.

LABORATORY AND DIAGNOSTIC FINDINGS

Definitive diagnosis of a sleep-related breathing disorder is made by PSG, in which the patient's brain waves, breathing, and other physiologic parameters are recorded during sleep. As noted earlier, a PSG is an overnight sleep study that is performed in a laboratory setting. During the performance of a standard laboratory-based PSG, a technician who is present throughout the night records the activities of the patient during sleep. Multiple physiologic parameters are monitored and recorded on a computer. The components of a PSG typically include EEG to monitor brain waves, electrooculogram (EOG) to monitor eye movements, electromyogram (EMG) to monitor jaw muscle activity and leg movements, electrocardiogram (ECG) to monitor heart rate and rhythm, pulse oximetry to monitor blood oxygen saturation, nasal thermistor monitoring of nasal airflow and CO₂ levels, and use of chest and abdominal strain gauges to track breathing efforts.

After recording sensors are attached, the patient is allowed to go to sleep. Most contemporary sleep laboratories have sleeping rooms that are nicely decorated, resembling a normal bedroom. In addition to the sensors attached to the patient, an infrared camera often is used to enable the technician to watch patient movements, such as leg movements or sleep walking, or to relate sleeping position to periods of disturbed breathing. A microphone is present in the room to record snoring or other sounds such as tooth grinding or sleep talking.

A typical PSG study encompasses the entire night and usually is sufficient to make a diagnosis despite obvious questions about the "normality" of the night's sleep in such an environment. Often, a diagnosis can be made early in the course of the night, and a trial of therapy with positive airway pressure (PAP) will be attempted. This is called a *split-night study*. If trial PAP therapy is not possible during the initial PSG, a second sleep study may be necessary to assess the effects of PAP. A computer recording of the entire night is produced (Fig. 9.7); this tracing is scrutinized and interpreted by a qualified physician trained in sleep medicine, who then makes a diagnosis and recommends treatment.

THE EPWORTH SLEEPINESS SCALE

Name: _____

Today's date: _____ Your age (years): _____

Your sex (male = M; female = F): _____

How likely are you to doze off or fall asleep in the following situations, in contrast to feeling just tired? This refers to your usual way of life in recent times. Even if you have not done some of these things recently try to work out how they would have affected you. Use the following scale to choose the *most appropriate number* for each situation:

0 = would *never* doze
 1 = *slight* chance of dozing
 2 = *moderate* chance of dozing
 3 = *high* chance of dozing

Situation	Chance of dozing
Sitting and reading	_____
Watching TV	_____
Sitting, inactive in a public place (e.g., a theater or a meeting)	_____
As a passenger in a car for an hour without a break	_____
Lying down to rest in the afternoon when circumstances permit	_____
Sitting and talking to someone	_____
Sitting quietly after a lunch without alcohol	_____
In a car, while stopped for a few minutes in the traffic	_____

Thank you for your cooperation

FIG 9.6 Epworth Sleepiness Scale. (Redrawn from Johns MW: A new method for measuring daytime sleepiness: the Epworth sleepiness scale, *Sleep* 14:540-545, 1991.)

Although the in-laboratory PSG has been the gold standard for the diagnosis of sleep-disordered breathing, because of economic factors and convenience, portable in-home monitoring has gained popularity and increasing acceptance because of less expense and better patient acceptance.³¹

Quantification of OSA severity is expressed by means of the *apnea-hypopnea index* (AHI) or the *respiratory disturbance index* (RDI). These two indices commonly are used interchangeably; however, there is a technical difference between the two. The AHI is scored by adding all of the apneic episodes together with all of the hypopneic episodes that occurred during the night and then dividing this total by the number of hours slept. The result is expressed as the average number of respiratory events per hour. To calculate the RDI, respiratory effort–related arousals (RERAs) are added to the apneas and hypopneas. It is important to define these terms for use in characterizing the various sleep disorders. According to the

American Academy of Sleep Medicine,³² an *apnea* (apneic episode) is defined as the cessation or near-complete cessation (>90% reduction) of airflow for a minimum of 10 seconds. *Hypopnea* is an episode of greater than 30% reduction in amplitude in thoracoabdominal movement or airflow from baseline, with a greater than 3% oxygen desaturation. *RERAs* are episodes that include a clear drop in respiratory airflow, increased respiratory effort, and a brief change in sleep state (arousal) but do not meet the criteria for an apnea or a hypopnea.

A diagnosis of OSA is made if the AHI or RDI is greater than 5/hour and symptoms of excessive daytime sleepiness, witnessed nocturnal apneas, or awakening with choking, breath holding, or gasping are noted. In quantifying the severity of OSA, some disagreement has been expressed; however, a commonly used classification defines an AHI of 0 to 5/hour as normal, 5 to 15/hour as mild, 15 to 30/hour as moderate, and greater than 30/hour as severe. Along with the AHI, the lowest point (nadir) of

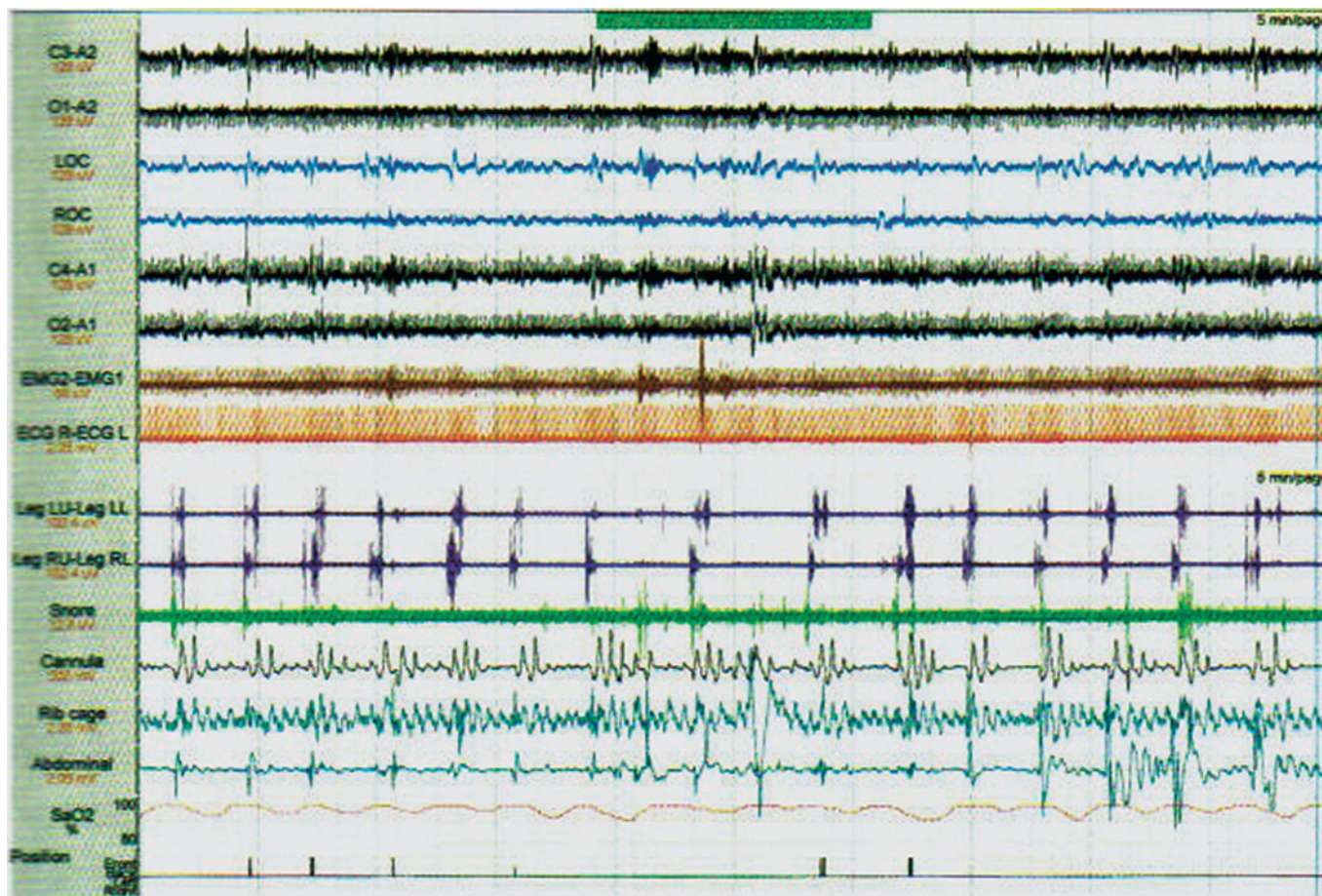

FIG 9.7 A 5-minute epoch of a polysomnogram. *C3-A2*, *O1-A2*, *C4-A1*, and *O2-A1* are electroencephalographic leads used to determine sleep stages. *LOC* and *ROC* designate eyelid leads at left and right outer canthi, respectively, for recording rapid eye movement. *EMG* tracing is an electromyogram of the chin used to record jaw movement. *ECG* tracing is an electrocardiogram that records heart rate and rhythm. *Leg LU* and *Leg RU* designate leads for recording leg movements. *Snore* tracing tracks the subject's snoring. *Cannula* designates measurement of nasal airflow pressure. *Rib cage* tracing is a recording of rib cage movement. *Abdominal* tracing is a recording of abdominal movement. *SaO₂* is blood oxygen saturation. *Position* tracing is a recording of body position. (From Phillips B, Naughton M: *Fast facts: obstructive sleep apnea*, Oxford, 2004, Health Press Limited.)

oxygen desaturation is reported. UARS is diagnosed in the presence of RERAs, an AHI less than 5/hour, and a complaint of excessive daytime sleepiness. Primary snoring is associated with completely normal findings on the PSG, with no complaint of excessive sleepiness in the presence of snoring.

Other aspects of the PSG that may be reported are total time spent in the various sleep stages, AHI for various sleep stages, and AHI for various sleep positions. In addition, a sleep histogram, which is a graph of the sleep pattern during the entire night that depicts cycling into and out of the various sleep stages, may be provided. Other tests that may be used include the *multiple sleep latency test* (MSLT), which assesses the ability to fall asleep, and the *maintenance of wakefulness test* (MWT), which assesses the ability to stay awake.

MEDICAL MANAGEMENT

The decision of when and how to treat sleep-related breathing disorders depends on the diagnosis and the severity of the disorder. Treatment of primary snoring is elective and essentially is a personal decision commonly motivated by the effects of snoring on a spouse or bed partner. Of interest, snoring rarely disturbs the snorer. Parents of a child who snores often seek treatment out of concern for the health of the child. Patients who are given a diagnosis of UARS should receive treatment to alleviate the problems associated with snoring, as well as those resulting from sleep fragmentation and resultant sleepiness. Simple snoring as well as UARS can progress, evolving into OSA over time, most often caused by weight gain or aging (or both). Patients who are given a diagnosis

of OSA require treatment, not only to alleviate snoring and sleepiness but also to prevent or treat the numerous adverse health effects associated with the disease. Even mild sleep apnea is associated with significant morbidity and mortality, which increases with severity.²⁶ Treatment of OSA involves four different approaches: behavioral modification, PAP, use of oral appliances, and surgery.

Behavioral Modification

Several measures may help to decrease or eliminate the signs or symptoms of sleep-related breathing disorders. Weight loss is one of the most effective measures that can be instituted; however, it may not result in normalization alone.³³ Even modest weight loss can result in significant improvement. Furthermore, independent of body habitus, regular aerobic exercise has been shown to be of clinical benefit in patients with OSA.³⁴ For patients with obstruction in the nasal cavity, nasal dilator strips may be helpful to physically open the nasal passages, as may the use of nasal decongestants, topical corticosteroids, or both. Many patients with OSA have positional apnea, with apneas occurring more frequently or with greater severity in the supine position.³⁵ For patients with position-dependent apnea, measures to prevent sleeping in a supine position may be helpful and include sewing a tennis ball into a pocket on the back of the pajamas, using a backpack-type device, or placement of pillows to maintain a side-sleeping posture. Alcohol, sedatives, or muscle relaxants near bedtime should be avoided. Patients who smoke should be encouraged to quit smoking, although the relationship between smoking and OSA remains unclear. Oral or nasal lubricants or sprays, as well as dietary supplements, magnets, hypnosis, and other treatment methods based in alternative and complementary medicine, have been purported to relieve snoring; however, credible evidence of effectiveness is lacking.

Positive Airway Pressure

The “gold standard” of treatment for OSA is the delivery of PAP to the patient’s airway during sleep. This is accomplished with the use of an air compressor that is connected by tubing to a nasal or full face mask attached to the patient’s face (Fig. 9.8). Room air is delivered under pressure to the patient’s airway, where it acts in effect as a pneumatic stent, producing positive intraluminal pressure along the entire pharyngeal airway, thereby maintaining patency. The air can be heated and humidified.

An advantage of PAP is that it relieves obstruction at all levels of the airway. Delivery of PAP may be accomplished using one of three modalities:

1. Continuous positive airway pressure (CPAP)
2. Bilevel positive airway pressure (BiPAP or BPAP)
3. Auto-adjusting positive airway pressure (APAP)

CPAP provides air continuously throughout inspiration and exhalation at a single, set pressure, expressed in cm H₂O. BiPAP consists of two set pressures, with use of a



FIG 9.8 Patient using a positive airway pressure device with a nasal mask. (Courtesy of June Sorrenson, CRT, Lexington, KY.)

higher pressure during inhalation and a lower pressure setting for during exhalation. With APAP, pressures vary continuously according to what is sensed to be required at a particular moment to maintain airway patency. CPAP is most often titrated to an effective level during a PSG in the sleep laboratory, either as part of a split-night study or during a subsequent full-night study. Pressures typically are started at 3 to 5 cm H₂O and are gradually titrated upward until all manifestations of OSA are eliminated. With CPAP, typical treatment pressures range between 5 and 15 cm H₂O.

In a review of PAP,³⁶ it was concluded that PAP eliminated respiratory disturbances and reduces AHI compared with placebo, conservative management, or positional therapy. It also improves stage 3 and 4 sleep and decreases EEG arousals versus placebo. It significantly improves sleep architecture and sleep fragmentation, but these effects are not always consistent. In addition, daytime sleepiness may be decreased and neurobehavioral performance, psychological functioning, and quality of life may be improved.

The impact on cardiovascular risk is unclear; however, there appears to be a trend toward reduction of risk.³⁷ Compliance with PAP has long been a problem, with only about 50% of patients who try it able to tolerate it. Of those who are able to use PAP, the average patient uses it for only about 4 to 5 hours per night and for only about 5 nights per week.³⁶ Adverse effects with PAP are common and include mask leaks, skin ulceration or irritation under the mask, epistaxis, rhinorrhea, nasal congestion, sinus congestion, dry eyes, conjunctivitis, ear pain, and claustrophobia.

Oral Appliances

Oral appliances offer an attractive alternative for the management of sleep-related breathing disorders (1) as a primary treatment option, (2) in patients who are unable



FIG 9.9 Examples of oral appliances used for the treatment of obstructive sleep apnea. **A**, SomnoDent MAS (Mandibular Advancement Splint). **B**, Modified Herbst appliance. **C**, TAP-T (Thornton Adjustable Positioner). (A, Courtesy of Somnomed, Inc., Denton, TX. B, Courtesy of Great Lakes Orthodontics, Tonawanda, NY. C, Courtesy Airway Management, Inc., Dallas, TX.)

to tolerate the use of PAP, or (3) in patients who refuse to use PAP. Oral appliances exert their effects by mechanically increasing the volume of the upper airway in the retropalatal and retroglottal areas, as has been confirmed by imaging and physiologic monitoring.³⁸ These areas of the oropharynx are the most common sites of obstruction in patients with OSA.³⁹ With the use of these devices, one would expect an increase in airway size to be greater in the retroglottal than in the retropalatal region because they pull the tongue forward. However, studies have shown that wearing oral appliances is associated with increased airway size in *both* the retropalatal and retroglottal regions, with increases occurring not only anteroposteriorly but in the lateral dimension as well.⁴⁰

The two basic types of oral appliances are (1) mandibular advancement devices (MADs), which engage the mandible and reposition it (and indirectly, the tongue) in an anterior or forward position (Fig. 9.9), and (2) tongue-retaining devices (TRDs), which directly engage the tongue and hold it in a forward position (Fig. 9.10). Many different types of OAs are available to treat snoring and OSA; however, not all have been approved by the U.S.



FIG 9.10 Example of oral appliance used for the treatment of obstructive sleep apnea. MPOWRX tongue retainer.

Food and Drug Administration for specific use in the treatment of OSA.

Mandibular advancement devices are the type of oral appliance most commonly used to treat patients with sleep-related breathing disorders. They are typically custom made of acrylic resin and are composed of two pieces that cover the upper and lower dental arches (similar to retainers or athletic mouth guards) and are connected together in such a way as to reposition and hold the mandible in a forward position. The parts may be fused together into a single (monoblock), nonadjustable appliance, or they may be connected in such a way as to allow some degree of mandibular movement and adjustability (titratability) between the two pieces. Several over-the-counter, so-called “boil and bite” appliances are available in drug stores and on the Internet; however, they tend to be unsatisfactory for serious use and are not recommended.

Tongue-retaining devices are made of silicone in the shape of a bulb or cavity with wings that fit outside the mouth or between the teeth and lips. The tongue is stuck into the bulb, which is then squeezed and released, producing a suction that holds the tongue forward in the bulb. TRDs generally provide treatment effects similar to those achieved with MADs; however, they are not tolerated as well as are MADs.⁴¹ Also available is a hybrid type of tongue displacement appliance that fits over one or both arches and depresses the tongue and guides it forward without moving the mandible.⁴²

When compared with PAP, MADs are not as effective in treating OSA, especially the more severe cases, but about two thirds of patients benefit from using oral appliances, with either complete or partial success.⁴³ They are generally well tolerated, and patients tend to prefer MADs compared with wearing PAP devices; however, adverse effects are common. Fortunately, most such effects are minor and transient and resolve quickly on removal of the device. Common problems include temporomandibular joint (TMJ) pain, muscular pain, tooth pain, hypersalivation, TMJ sounds, dry mouth, gum irritation, and occlusal changes.⁴⁴ Infrequently, a patient may develop jaw pain severe enough that may prevent use of the device.

The American Academy of Sleep Medicine has recently published practice parameters and revised clinical guidelines for the use of OAs in the treatment of snoring and OSA.⁴⁵ They recommend that a qualified dentist use a custom-made titratable appliance over a noncustom appliance with regular oversight or follow-up to survey for side effects or dental changes. Furthermore, it is recommended that the sleep physician perform follow-up sleep testing to confirm treatment efficacy. Use of an oral appliance is recommended for the following categories of patients:

- Patients with primary snoring
- Patients with mild to moderate OSA who prefer OAs to CPAP, who do not respond to CPAP, who are not

appropriate candidates for CPAP, or who do not obtain adequate relief with CPAP or behavioral measures

- Patients with severe OSA in whom an initial trial of CPAP has failed to correct the problem

Also of note, upper airway surgery may supersede the use of oral appliances in patients for whom such operations are predicted to be highly effective.

Surgical Approaches

A variety of surgical procedures have been advocated to treat OSA, including tracheostomy, tonsillectomy, adenoidectomy, nasal septoplasty, turbinate reduction, uvulopalatopharyngoplasty (UPPP), laser-assisted uvulopalatoplasty (LAUP), radiofrequency volumetric tissue reduction (RVTR), pillar implants, genioglossus advancement–hyoid myotomy and suspension (GAHMS), tongue base reduction, maxillary and mandibular advancement osteotomy (MMO), and bariatric surgery. Some of these procedures achieve relatively modest success rates when performed alone. For example, with UPPP, the surgical procedure most commonly performed to correct OSA, the success rate is less than 50%.⁴⁶ With others, such as MMO or performance of a combination of procedures, much higher success rates are reported. Tracheostomy, which bypasses all obstruction in the entire upper airway, is almost uniformly effective in curing OSA. Its use is limited, however, in that it is unacceptable to most patients but may be used for the occasional patient with very severe OSA who is intolerant of CPAP and who requires urgent treatment. Another predictably successful procedure is the removal of adenoids and tonsils in children. The LAUP procedure was found not to be effective and is not recommended for treatment of OSA.⁴⁷

Because upper airway surgery is invasive and irreversible, efforts must be made to identify the site(s) of obstruction to determine which surgical approach should be used and to avoid unnecessary or ineffective surgery. A number of imaging techniques and laboratory modalities, including cephalometrics, computed tomography scanning, nasopharyngoscopy, and measurements of regional pharyngeal pressure, flow, and resistance have been used for this purpose. A phased approach to surgery, beginning with less aggressive procedures and advancing to more aggressive interventions when the response to initial treatment is inadequate, is often advocated.

Complications and adverse effects of upper airway surgery vary with the procedure.⁴⁸ For example, UPPP may result in velopharyngeal insufficiency, velopharyngeal stenosis, voice changes, postoperative bleeding, postoperative airway obstruction, and death. MMO and GAHMS may result in lip, cheek, or chin paresthesia or anesthesia, as well as tooth injury, postoperative bleeding, postoperative airway obstruction, and changes in facial appearance.

Because obesity is a major risk factor for OSA, bariatric surgery has become a more commonly accepted treatment

for patients with severe obesity. Morbid or severe obesity is defined as a BMI of 40 or greater. In a large study, it was confirmed that surgically induced weight loss results in significant relief of clinical signs and symptoms associated with obesity-related OSA.⁴⁹

REFERENCES

- Mokhlesi B. Obesity hypoventilation syndrome: a state-of-the-art review. *Respir Care*. 2010;55(10):1347-1362, discussion 1363-1345.
- Naughton MT. Epidemiology of central sleep apnoea in heart failure. *Int J Cardiol*. 2016;206(suppl):S4-S7.
- Silber MH, Ancoli-Israel S, Bonnet MH, et al. The visual scoring of sleep in adults. *J Clin Sleep Med*. 2007;3(2):121-131.
- Carskadon M, Dement W. Normal human sleep: an overview. In: Kryger MH, Roth T, Dement W, eds. *Principles and Practice of Sleep Medicine*. 4th ed. Philadelphia: Saunders; 2005:13-23.
- Youngstedt SD, Goff EE, Reynolds AM, et al. Has adult sleep duration declined over the last 50+ years? *Sleep Med Rev*. 2016;28:69-85.
- Deary V, Ellis JG, Wilson JA, et al. Simple snoring: not quite so simple after all? *Sleep Med Rev*. 2014;18(6):453-462.
- George CF. Sleep. 5: driving and automobile crashes in patients with obstructive sleep apnoea/hypopnoea syndrome. *Thorax*. 2004;59(9):804-807.
- Tregear S, Reston J, Schoelles K, et al. Obstructive sleep apnea and risk of motor vehicle crash: systematic review and meta-analysis. *J Clin Sleep Med*. 2009;5(6):573-581.
- Chobanian AV, Bakris GL, Black HR, et al. The Seventh Report of the Joint National Committee on Prevention, Detection, Evaluation, and Treatment of High Blood Pressure: the JNC 7 report. *JAMA*. 2003;289(19):2560-2572.
- Yaggi HK, Concato J, Kernan WN, et al. Obstructive sleep apnea as a risk factor for stroke and death. *N Engl J Med*. 2005;353(19):2034-2041.
- Mehra R, Benjamin EJ, Shahar E, et al. Association of nocturnal arrhythmias with sleep-disordered breathing: the Sleep Heart Health Study. *Am J Respir Crit Care Med*. 2006;173(8):910-916.
- Javaheri S, Wexler L. Prevalence and treatment of breathing disorders during sleep in patients with heart failure. *Curr Treat Options Cardiovasc Med*. 2005;7(4):295-306.
- Punjabi NM, Shahar E, Redline S, et al. Sleep-disordered breathing, glucose intolerance, and insulin resistance: the Sleep Heart Health Study. *Am J Epidemiol*. 2004;160(6):521-530.
- Young T, Finn L, Peppard PE, et al. Sleep disordered breathing and mortality: eighteen-year follow-up of the Wisconsin sleep cohort. *Sleep*. 2008;31(8):1071-1078.
- Unhealthy sleep-related behaviors—12 states, 2009. *MMWR Morb Mortal Wkly Rep*. 2011;60(8):233-238.
- Lindberg E, Taube A, Janson C, et al. A 10-year follow-up of snoring in men. *Chest*. 1998;114(4):1048-1055.
- Ng DK, Chow PY, Chan CH, et al. An update on childhood snoring. *Acta paediatrica (Oslo, Norway)*. 2006;95(9):1029-1035.
- Pien GW, Fife D, Pack AI, et al. Changes in symptoms of sleep-disordered breathing during pregnancy. *Sleep*. 2005;28(10):1299-1305.
- Young T, Palta M, Dempsey J, et al. The occurrence of sleep-disordered breathing among middle-aged adults. *N Engl J Med*. 1993;328(17):1230-1235.
- Chang SJ, Chae KY. Obstructive sleep apnea syndrome in children: epidemiology, pathophysiology, diagnosis and sequelae. *Korean J Pediatr*. 2010;53(10):863-871.
- Patil SP, Schneider H, Schwartz AR, et al. Adult obstructive sleep apnea: pathophysiology and diagnosis. *Chest*. 2007;132(1):325-337.
- Schwab RJ, Pasirstein M, Pierson R, et al. Identification of upper airway anatomic risk factors for obstructive sleep apnea with volumetric magnetic resonance imaging. *Am J Respir Crit Care Med*. 2003;168(5):522-530.
- Series F. Upper airway muscles awake and asleep. *Sleep Med Rev*. 2002;6(3):229-242.
- Bisogni V, Pengo MF, Maiolino G, et al. The sympathetic nervous system and catecholamines metabolism in obstructive sleep apnoea. *J Thorac Dis*. 2016;8(2):243-254.
- Genta PR, Edwards BA, Sands SA, et al. Tube law of the pharyngeal airway in sleeping patients with obstructive sleep apnea. *Sleep*. 2016;39(2):337-343.
- Young T, Peppard PE, Gottlieb DJ. Epidemiology of obstructive sleep apnea: a population health perspective. *Am J Respir Crit Care Med*. 2002;165(9):1217-1239.
- Johns MW. Daytime sleepiness, snoring, and obstructive sleep apnea. The Epworth Sleepiness Scale. *Chest*. 1993;103(1):30-36.
- Resta O, Foschino-Barbaro MP, Legari G, et al. Sleep-related breathing disorders, loud snoring and excessive daytime sleepiness in obese subjects. *Int J Obes Relat Metab Disord*. 2001;25(5):669-675.
- Katz I, Stradling J, Slutsky AS, et al. Do patients with obstructive sleep apnea have thick necks? *Am Rev Respir Dis*. 1990;141(5 Pt 1):1228-1231.
- Davies RJ, Ali NJ, Stradling JR. Neck circumference and other clinical features in the diagnosis of the obstructive sleep apnoea syndrome. *Thorax*. 1992;47(2):101-105.
- Cooksey JA, Balachandran JS. Portable monitoring for the diagnosis of OSA. *Chest*. 2016;149(4):1074-1081.
- Berry RB, Budhiraja R, Gottlieb DJ, et al. Rules for scoring respiratory events in sleep: update of the 2007 AASM Manual for the Scoring of Sleep and Associated Events. Deliberations of the Sleep Apnea Definitions Task Force of the American Academy of Sleep Medicine. *J Clin Sleep Med*. 2012;8(5):597-619.
- Araghi MH, Chen YF, Jagielski A, et al. Effectiveness of lifestyle interventions on obstructive sleep apnea (OSA): systematic review and meta-analysis. *Sleep*. 2013;36(10):1553-1562, 1562a-1562e.
- Peppard PE, Young T. Exercise and sleep-disordered breathing: an association independent of body habitus. *Sleep*. 2004;27(3):480-484.
- Ravesloot MJ, van Maanen JP, Dun L, et al. The undervalued potential of positional therapy in position-dependent snoring and obstructive sleep

- apnea—a review of the literature. *Sleep & breathing = Schlaf & Atmung*. 2013;17(1):39-49.
36. Gay P, Weaver T, Loube D, et al. Evaluation of positive airway pressure treatment for sleep related breathing disorders in adults. *Sleep*. 2006;29(3):381-401.
 37. Guo J, Sun Y, Xue LJ, et al. Effect of CPAP therapy on cardiovascular events and mortality in patients with obstructive sleep apnea: a meta-analysis. *Sleep Breath*. 2016;20(3):965-974.
 38. Ferguson KA, Cartwright R, Rogers R, et al. Oral appliances for snoring and obstructive sleep apnea: a review. *Sleep*. 2006;29(2):244-262.
 39. Rama AN, Tekwani SH, Kushida CA. Sites of obstruction in obstructive sleep apnea. *Chest*. 2002;122(4):1139-1147.
 40. Ryan CF, Love LL, Peat D, et al. Mandibular advancement oral appliance therapy for obstructive sleep apnoea: effect on awake calibre of the velopharynx. *Thorax*. 1999;54(11):972-977.
 41. Deane SA, Cistulli PA, Ng AT, et al. Comparison of mandibular advancement splint and tongue stabilizing device in obstructive sleep apnea: a randomized controlled trial. *Sleep*. 2009;32(5):648-653.
 42. Singh GD, Keropian B, Pillar G. Effects of the full breath solution appliance for the treatment of obstructive sleep apnea: a preliminary study. *Cranio*. 2009;27(2):109-117.
 43. Sutherland K, Vanderveken OM, Tsuda H, et al. Oral appliance treatment for obstructive sleep apnea: an update. *J Clin Sleep Med*. 2014;10(2):215-227.
 44. de Almeida FR, Lowe AA, Tsuiji S, et al. Long-term compliance and side effects of oral appliances used for the treatment of snoring and obstructive sleep apnea syndrome. *J Clin Sleep Med*. 2005;1(2):143-152.
 45. Ramar K, Dort LC, Katz SG, et al. Clinical practice guideline for the treatment of obstructive sleep apnea and snoring with oral appliance therapy: an update for 2015. *J Clin Sleep Med*. 2015;11(7):773-827.
 46. Maurer JT. Update on surgical treatments for sleep apnea. *Swiss Med Wkly*. 2009;139(43-44):624-629.
 47. Aurora RN, Casey KR, Kristo D, et al. Practice parameters for the surgical modifications of the upper airway for obstructive sleep apnea in adults. *Sleep*. 2010;33(10):1408-1413.
 48. Franklin KA, Anttila H, Axelsson S, et al. Effects and side-effects of surgery for snoring and obstructive sleep apnea—a systematic review. *Sleep*. 2009;32(1):27-36.
 49. Haines KL, Nelson LG, Gonzalez R, et al. Objective evidence that bariatric surgery improves obesity-related obstructive sleep apnea. *Surgery*. 2007;141(3):354-358.

PART IV

Gastrointestinal Disease

Liver Disease

The liver has a number of key functions, including metabolism of the byproducts of food, detoxification of drugs, conversion of nitrogenous substances to be excreted by the kidneys, formation of blood clotting factors, metabolism of bilirubin, processing of lipids from the intestines, and storage of glycogen. Obviously then, clinical consequences of liver dysfunction manifest in loss of hepatocellular function, including diminished detoxification, metabolic, elimination, and coagulation problems.¹⁻⁵ Liver dysfunction may be attributed to a number of causes, including acquired infections and other pathologic conditions, as well as drug use. A patient with liver disease presents a significant management challenge for the dentist because the liver plays a vital role in metabolic functions, including the secretion of bile needed for fat absorption; conversion of sugar to glycogen; and excretion of bilirubin, a waste product of hemoglobin metabolism. Impairment of liver function can lead to abnormalities in many biochemical functions performed by the liver, such as synthesis of coagulation factors and drug metabolism, and dental patients with acute or chronic liver disease may be adversely affected. Therefore, significant bleeding may be a problem.¹⁻⁵ In many cases, the liver dysfunction will continue to progress over time. Ultimately, serious end-stage liver dysfunction or cirrhosis may result.

Cirrhosis is the consequence of long-term damage to the liver tissues. This condition is irreversible and leads to fibrosis, resulting in jaundice, ascites, and portal hypertension, as well as significant liver dysfunction. The potential causes of viral hepatitis-related cirrhosis are listed in [Table 10.1](#). Obviously, liver disorders in persons presenting for treatment are of significant clinical interest to dentists in the context of the proper management of such patients. In this chapter, the two most common liver disorders and main causes of cirrhosis, hepatitis and alcoholic liver disease, are presented.

CRITICAL COMPLICATIONS: Patients with chronic liver disease are at high risk during dental treatment for complications such as adverse bleeding, altered drug metabolism, and infection. These events could prove serious. The dentist must be able to detect these patients based on history and clinical findings, refer them for medical diagnosis and management, and work closely with the physician to develop a dental management plan that will be effective and safe for the patient.^{2,4,5}

HEPATITIS

General Description

Hepatitis is inflammation of the liver that may result from infectious or other causes. Examples of hepatitis with infectious causes are viral hepatitis and that associated with infectious mononucleosis, secondary syphilis, and tuberculosis. Approximately 15,000 people in the United States die each year of cirrhosis caused by viral hepatitis.^{6,7} Also, noninfectious hepatitis can result from excessive or prolonged use of toxic substances, including drugs (i.e., acetaminophen, halothane, ketoconazole, methyldopa, and methotrexate) or, more commonly, alcohol.^{2,7-10}

Because the several types of hepatitis have various degrees of impact on dental treatment, each is discussed separately in subsequent sections.

Viral hepatitis is a collective term describing liver inflammation or hepatitis caused by a group of several different viruses. Three viruses, hepatitis A virus (HAV), hepatitis B virus (HBV), and hepatitis C virus (HCV), cause most cases of viral hepatitis in the United States. Because hepatitis A is transmitted primarily in unsanitary conditions, the number of annual cases has declined significantly in the United States in recent years as a result of vaccination programs and food safety efforts.

Unlike HAV hepatitis, infections by HBV and HCV are bloodborne and often persist for years, resulting in ongoing (chronic) but usually asymptomatic liver inflammation and, in some cases, scarring (cirrhosis) that leads to liver failure, liver cancer, or both. Chronic hepatitis is a major cause of liver cancer and chronic liver disease globally and in the United States.^{6,7,10,11}

Epidemiology

Acute viral hepatitis is a common disease that affects 0.5% to 1.0% of persons in the United States with approximately 80,000 new cases each year. The annual incidence of acute hepatitis has been decreasing steadily since 1990, largely because of the use of hepatitis A and B vaccines and decrease in high-risk behaviors.^{9,10} Worldwide, approximately 540 million persons are living with chronic viral hepatitis, with approximately 370 million infected with HBV and approximately 170 million infected with HCV.^{6,7,11}

Chronic hepatitis causes considerable morbidity. Globally, an estimated 78% of primary liver cancer and 57%

TABLE 10.1 Most Common Agents of Acute Viral Hepatitis, With Associated Characteristics

Hepatitis Virus	Size (nm)	Genome	Spread*	Incubation Period (Days)	Fatality Rate (%)	Chronicity Rate (%)	Antibody	Diagnosis ^{††}
A (HAV)	27	RNA	Fecal–oral	15–45; mean, 25	1	None	Anti-HAV	Anti-HAV IgG
B (HBV)	45	DNA	Parenteral	30–180; mean, 75	1	2–7	Anti-HBs	HBsAg (infectious) Anti-HBsAg (recovery) Anti-HBc (acute, persistently infected nonprotective) HBeAg (infectious) Anti-HBeAg (clearing/cleared infection)
C (HCV)	60	RNA	Parenteral Sexual	15–150; mean, 50	<0.1	50–85	Anti-HBc Anti-HBe Anti-HCV	Anti-HCV (previous infection) HCV RNA (infectivity)
D (delta) (HDV)	40	RNA	Parenteral	30–150	2–10	2–7	Anti-HDV	Anti-HDV HD-Ag
E (HEV)	32	RNA	Sexual Fecal–oral	30–60	1	None	Anti-HEV	Anti-HEV

HBc, Hepatitis B core; HBeAg, hepatitis B e antigen; HBsAg, hepatitis B surface antigen; HCC, hepatocellular carcinoma; IgG, immunoglobulin G.

*With parenteral and sexual modes of transmission: Risk groups include intravenous drug users, health care workers, hemodialysis patients, persons of low socioeconomic status, sexual and household contacts of infected persons, persons with multiple sex partners, and patients with a history of transfusion before 1991.

The U.S. Food and Drug Administration requires that all donated whole blood, transfusable components, and plasma for human blood use in the United States be subjected to serologic testing for syphilis, HBsAg, anti-HBc, anti-HCV, and anti-HIV. The current incidence of posttransfusion hepatitis B is approximately 0.002% per transfusion recipient.

A small number of cases of transmission of HAV through clotting factor concentrates also have been reported.

Data from Centers for Disease Control and Prevention: Hepatitis A among persons with hemophilia who received clotting factor concentrate—United States, September–December 1995, *MMWR Morb Mortal Wkly Rep* 45:29–32, 1996.

of liver cirrhosis are caused by chronic viral hepatitis, and about 1 million deaths from viral hepatitis occur each year.^{1,6,7,11} Liver cancer is the fourth leading cause of death from cancer worldwide and the third leading cause among men. In the United States, acute infection leads to chronic viral hepatitis in approximately 4.5 million Americans.^{7,10,11} The vast majority, an estimated 75%, are not aware they are infected. In the absence of appropriate treatment, liver cirrhosis will develop in 15% to 40% of infected persons.^{7,10,11}

Etiology

The clinical manifestations of the five forms of viral hepatitis are quite similar, and the diseases can be distinguished from each other only by serologic assays.^{2,9,11} The five known causes of acute hepatitis are hepatitis virus types A (HAV), B (HBV), C (HCV), D or delta (HDV), and E (HEV) (see Table 10.1). All except HBV

are RNA viruses. Hepatitis A and hepatitis E are forms of *infectious* hepatitis; they are spread largely by the fecal–oral route, are associated with poor sanitary conditions, are highly contagious, occur in outbreaks as well as sporadically, and cause self-limited hepatitis only. Hepatitis B, hepatitis C, and hepatitis D are forms of *serum* hepatitis, are spread largely by parenteral routes and less commonly by intimate or sexual exposure, and are not highly contagious but instead occur sporadically and rarely cause outbreaks. They are capable of leading to chronic infection and, ultimately, to cirrhosis and hepatocellular carcinoma. Cases of an acute viral hepatitis–like syndrome that cannot be identified as being caused by a known hepatitis virus have been reported; this syndrome has been called acute *non-A, non-B, non-C, non-D, non-E (non-A-E) hepatitis* or *acute hepatitis of unknown cause*. Despite many attempts, the viral etiology of non-A-E hepatitis remains unproved.^{2,3a,11}

Chronic Carrier State	Complications [§] of the Liver	Associated Clinical Syndromes	IMMUNIZATION	
			Passive	Active
No	Rare		Immune globulin (0.02 mg/kg)	Harivax, Vaqta, Twinrix
Yes—90% risk of becoming carrier if infected as neonate; 25%–50% risk if infected as infant; 5%–10% risk if infected as adult	Yes—increased risk of cirrhosis and HCC after 25–30 years of infection	Yes	Hepatitis B immune globulin (HBIG) (0.06 mg/kg)	Recombivax, Engerix, Twinrix
Yes—risk of becoming carrier is 80%–90%	Yes—10-fold increased risk of liver cirrhosis within 20 years; 1%–5% of carriers develop HCC by 20 years, risk of HCC with chronic HCV infection exceeds risk with chronic HBV infection	Yes	Not available	None (difficult development because of the many genotypes)
Yes—carrier state in 20%–70%	Yes		Not available	Yes—protected with Recombivax, Engerix , and Twinrix
No	Rare morbidity and mortality except in pregnant women		Not available	Genentech has applied for vaccine patent

†Diagnostic markers of viral hepatitis include elevation of aspartate aminotransferase, alanine aminotransferase, γ -glutamyl transferase, and white blood cell count and prolongation of prothrombin time.

‡*Preactic phase*: anorexia, nausea, vomiting, fatigue, myalgia, malaise, fever. *Icterus*: jaundice, discolored stool, dark urine, hepatosplenomegaly, bleeding disorder. *Serum sickness-like features*: arthralgia, rash, angioedema (seen in 5%–10% of patients).

§Risk for complications and severe liver disease increases with coinfection with HBV and HCV and with chronic alcohol consumption.

|| Immunization is recommended for dental personnel.

Pathophysiology and Complications

The pathogenesis of the liver injury in viral hepatitis is not well understood. None of the five primary agents seems to be directly cytopathic, at least at levels of replication found during typical acute and chronic hepatitis. The timing and histologic appearance of hepatocyte injury in viral hepatitis suggest that immune responses, particularly cytotoxic T-cell responses to viral antigens expressed on hepatocyte cell membranes, may be the major effectors of injury. Other proinflammatory cytokines, natural killer cell activity, and antibody-dependent cellular cytotoxicity also may play modulating roles in cell injury and inflammation during acute hepatitis virus infection. Recovery from hepatitis virus infection usually is accompanied by the appearance of rising titers of antibody against viral envelope antigens, such as anti-HAV, anti-HBs, anti-HCV-E1 and anti-HCV-E2, and anti-HEV; these antibodies may provide at least partial immunity to reinfection.^{1,3a,11}

Clinical Presentation

The course of acute hepatitis is highly variable and ranges in severity from a transient, asymptomatic infection to severe or fulminant disease. The disease may be self-limited with complete resolution, run a relapsing course, or lead to chronic infection. In a typical, clinically apparent course of acute resolving viral hepatitis, the *incubation period* ranges from 2 to 20 weeks, as determined largely on the basis of the viral etiologic agent and exposure dose. During this phase, virus becomes detectable in blood, but serum aminotransferase and bilirubin levels are normal, and antibody is not detected.^{1,3a,10}

The *preicteric phase* of illness is marked by the onset of nonspecific symptoms such as fatigue, nausea, poor appetite, and vague right upper quadrant pain. Virus-specific antibody first appears during this phase. The preicteric phase typically lasts 3 to 10 days but may be of longer duration and even constitute the entire course of illness in patients with subclinical or anicteric forms

of acute hepatitis. Viral titers generally are highest at this point, and serum aminotransferase levels start to increase.^{1,3a,10}

The onset of production of dark urine marks the *icteric phase* of illness, during which jaundice appears and symptoms of fatigue and nausea worsen. Typically, acute viral hepatitis rarely is diagnosed correctly before the onset of jaundice. If jaundice is severe, stool color lightens, often in association with pruritus. Other manifestations may include anorexia, dysgeusia, and weight loss. Physical examination usually shows jaundice and hepatic tenderness. In more severe cases, hepatomegaly and splenomegaly may be present. Serum bilirubin levels (total and direct) rise, and aminotransferase levels generally are higher than 10 times the upper limit of normal, at least at the onset. During the icteric, symptomatic phase, levels of hepatitis virus begin to decrease in serum and liver.^{1,3a,10}

The duration of clinical illness is variable, typically lasting 1 to 3 weeks. Recovery is first manifested by return of appetite and is accompanied by resolution of the serum bilirubin and aminotransferase elevations and clearance of virus. *Convalescence* can be prolonged, however, before full energy and stamina return. Neutralizing antibodies usually appear during the icteric phase and rise to high levels during convalescence.^{1,3a,10}

Complications of acute viral hepatitis include chronic infection, fulminant hepatic failure, relapsing or cholestatic hepatitis, and extrahepatic syndromes. *Chronic hepatitis*, generally defined as illness of at least 6 months' duration, develops in approximately 2% to 7% of adults with hepatitis B and in 50% to 85% of adults with hepatitis C. Hepatitis B, C, and D infections are said to be chronic if viremia persists for more than 6 months, but chronicity can be suspected if viremia persists for 3 months after the onset of symptoms.^{1,3a,10}

Acute liver failure or fulminant hepatitis occurs in 1% to 2% of patients with symptomatic acute hepatitis, perhaps most commonly with hepatitis B and hepatitis D and least commonly with hepatitis C. The disease is called *fulminant* if evidence of hepatic encephalopathy appears; however, the initial symptoms (changes in personality, aggressive behavior, or abnormal sleep patterns) may be subtle or misunderstood. The most reliable prognostic factor in acute hepatic failure is the degree of prolongation of the prothrombin time; other signs of poor prognosis are persistently worsening jaundice, ascites, and decreases in liver size. Serum aminotransferase levels and viral titers have little prognostic value and often decrease with worsening hepatic failure.^{1,3a,10} In a proportion of cases of acute hepatitis, a cholestatic pattern of illness consisting of prolonged and fluctuating jaundice and pruritus develops. Patients may experience one or more clinical relapses and may feel relatively well despite marked jaundice. Cholestatic hepatitis generally is benign and ultimately resolves.^{1,3a,10}

In 10% to 20% of patients with acute hepatitis, a *serum sickness-like syndrome* marked by variable

combinations of rash, hives, arthralgias, and fever develops during the preicteric phase. This immune complex–like syndrome often is mistakenly attributed to other illnesses until the onset of jaundice, at which time the fever, hives, and arthralgias quickly resolve. Other extrahepatic manifestations of acute hepatitis are uncommon but may include severe headaches, encephalitis, aseptic meningitis, seizures, acute ascending flaccid paralysis, nephrotic syndrome, and seronegative arthritis.^{1,3a,10}

Laboratory and Diagnostic Findings

Serologic tests are adequate for the diagnosis of acute viral hepatitis (Table 10.2), so liver biopsy is not recommended unless the diagnosis remains unclear and a therapeutic decision is needed. If biopsy is required, the histologic pattern in acute viral hepatitis is characterized by widespread parenchymal inflammation and spotty necrosis. Inflammatory cells are predominantly lymphocytes, macrophages, and histiocytes. Fibrosis is absent. Results of immunohistochemical stains for hepatitis antigens generally are negative during the acute disease, and there are no reliably distinctive anatomic features in the liver that separate the five viral forms of acute hepatitis from each other.^{1,3a,10}

Medical Management

Although antiviral therapies have not been proved to be effective in prospective controlled trials, recent uncontrolled studies suggest that such therapies may be effective in acute hepatitis B and hepatitis C.^{1,3a,9-12} However, several recommendations are applicable to the management of all patients with acute hepatitis. Bedrest and good nutrition are appropriate for patients who are symptomatic and jaundiced. Alcohol should be avoided until after

TABLE 10.2 Serologic Diagnosis of Acute Hepatitis

Diagnosis	Screening Assays	Supplemental Assays
Hepatitis A	IgM anti-HAV	None needed
Hepatitis B	HBsAg, IgM anti-HBc	HBeAg, anti-HBe, HBV DNA
Hepatitis C	Anti-HCV by EIA	HCV RNA by PCR assay; anti-HCV by immunoblot analysis
Hepatitis D	HBsAg	Anti-HDV
Hepatitis E	History	Anti-HEV
Mononucleosis	History, WBC differential counts	Heterophile antibody
Drug-induced hepatitis	History	

EIA, Enzyme immunoassay; HAV, hepatitis A virus; HBc, hepatitis B core; HBeAg, hepatitis B e antigen; HBsAg, hepatitis B surface antigen; HBV, hepatitis B virus; HCV, hepatitis C virus; HDV, hepatitis D virus; HEV, hepatitis E virus; IgM, immunoglobulin M; PCR, polymerase chain reaction; WBC, white blood cell.

convalescence. Sexual contacts should be limited until partners receive prophylaxis. In hepatitis A, all household contacts should be given immune globulin, and initiation of HAV vaccination is appropriate. In hepatitis B, family members should be vaccinated, and hepatitis B immune globulin (HBIG) also should be given to recent sexual contacts. Patients in whom any signs of fulminant hepatic failure develop (prolongation of the prothrombin time, personality changes, confusion) should be considered for antiviral therapy and be evaluated quickly for possible liver transplantation (see Chapter 21). The success of transplantation for severe, acute viral hepatitis often depends on early referral and careful attention to all details of clinical care, with management provided by an experienced team of physicians. Follow-up evaluation for acute hepatitis should be adequate to show that resolution has occurred, particularly for patients with hepatitis C. Finally, and of greatest importance, all cases of acute hepatitis should be reported to the local or state health department as soon as possible after diagnosis.^{3a,12-14}

HEPATITIS A

Epidemiology

Hepatitis A is highly contagious and is spread largely by the fecal–oral route, especially when sanitary conditions are poor. Hepatitis A has been decreasing in frequency in the United States but is still an important cause of acute liver disease worldwide. Acute hepatitis A can occur in sporadic as well as epidemic forms. Investigation of the source of infection reveals that most cases are caused by direct person-to-person exposure and, to a lesser extent, to direct fecal contamination of food or water. Consumption of shellfish from contaminated waterways is a well known but quite uncommon means of acquiring hepatitis A. Rare instances of spread of hepatitis A by blood transfusions and administration of pooled plasma products have been described. Groups at high risk for acquiring hepatitis A include travelers to developing areas of the world, children in day care centers (and secondarily their parents), men who have sex with men, injection drug users, patients with hemophilia given plasma products, and residents and staff of institutions.^{3a,14-16}

Pathophysiology and Complications

Hepatitis A virus is a small RNA virus that belongs to the family Picornaviridae (genus *Hepatovirus*). The viral genome is 7.5 kilobases (kb) in length and has a single large open reading frame that encodes a polyprotein with structural and nonstructural components. The virus replicates largely in the liver and is assembled in the hepatocyte cytoplasm as a 27-nm particle with a single RNA genome and an outer capsid protein (HAVAg). The virus is secreted into bile and, to a lesser extent, serum. The highest titers of HAV are found in stool (10^6 to 10^{10} genomes per gram) during the incubation period and early symptomatic phase of illness.^{3a,14-16}

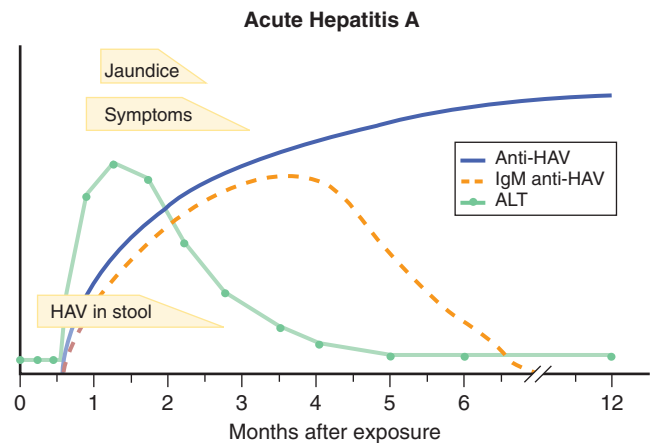

FIG 10.1 Serologic course of acute hepatitis A. ALT, Alanine aminotransferase; HAV, hepatitis A virus. (From Goldman L, Ausiello D, editors: *Cecil textbook of medicine*, ed 23, Philadelphia, 2008, Saunders.)

Clinical Presentation

The clinical course of typical acute hepatitis A (Fig. 10.1) begins with an incubation period that usually is 15 to 45 days in duration (mean, 25 days). Jaundice occurs in 70% of adults infected with HAV but in smaller proportions of children. Antibody to HAV (anti-HAV [IgG antibody]), which develops in all patients infected with the virus, is first detectable shortly before the onset of symptoms; titers then rise to high levels, which persist for life. By contrast, IgM-specific anti-HAV arises early in the disease and persists for only 4 to 12 months. Severe and fulminant cases of hepatitis A can occur, particularly in older adults and in patients with preexisting chronic liver disease. Hepatitis A is the most common cause of relapsing cholestatic hepatitis.^{3a,14-16}

Laboratory and Diagnostic Findings

The diagnosis of acute hepatitis A is made by detection of IgM anti-HAV in the serum of a patient with the clinical and biochemical features of acute hepatitis. Testing for total anti-HAV is not helpful in diagnosis but is used to assess immunity to hepatitis A.^{3a,14-16}

Medical Management

A safe and effective HAV vaccine is available and recommended for all children 1 year of age and older and for persons at increased risk for acquiring hepatitis A, including travelers to endemic areas of the world, men who have sex with men, and injection drug users. HAV vaccine also is recommended for all patients with chronic liver disease and recipients of pooled plasma products, such as patients with hemophilia. Two formulations of HAV vaccine are available in the United States; both consist of inactivated hepatitis A antigen purified from cell culture. Havrix (GlaxoSmithKline, Philadelphia, PA) is recommended to be given as two injections 6 to 12 months apart in an adult dose of 1440 enzyme-linked immunosorbent assay (ELISA) units (1.0 mL) and in a

pediatric (2–18 years of age) dose of 720 ELISA units (0.5 mL). Vaqta (Merck, West Point, PA) is recommended to be given as two injections 6 to 18 months apart in an adult dose of 50 U (1.0 mL) and in a pediatric dose (1–18 years) of 25 U (0.5 mL).^{15,16} A combination HAV–HBV vaccine (Twinrix) (GlaxoSmithKline) also is available; this preparation is recommended for adults who require vaccination against both forms of hepatitis and is given in a three-injection schedule at 0, 1, and 6 months after exposure. HAV vaccines have an excellent safety record, with serious complications occurring in fewer than 0.1% of recipients. Seroconversion rates after HAV vaccine are greater than 95% but are lower among patients with chronic liver disease, human immunodeficiency virus (HIV) infection, and other conditions of immunocompromise.^{15,16}

No specific therapies have been shown to shorten or ameliorate the course of illness in hepatitis A. An important element of management should be prophylaxis for contacts. Persons with fulminant hepatitis should be referred early for possible liver transplantation.^{15,16}

Acute hepatitis A is invariably a self-limited infection. The virus can persist for months, but this condition does not lead to chronic infection, chronic hepatitis, or cirrhosis.

HEPATITIS B

Epidemiology

Hepatitis B is spread predominantly by the parenteral route or by intimate personal contact. It is endemic in many areas of the world, such as Southeast Asia, China, Micronesia, and sub-Saharan Africa. Approximately 350 million people are infected with HBV worldwide.^{1,7,17,18} Lesser rates occur in the Indian subcontinent and the Middle East. In the United States, hepatitis B is the most common cause of acute hepatitis with approximately 4000 new cases of HBV per year (and ≈1.3 million cases of chronic HBV infection), although the incidence is decreasing (because of vaccinations and decreasing high-risk behavior)^{1,3a,9,19} (Fig. 10.2). Investigations of the source of infection reveal that most adult cases are caused by

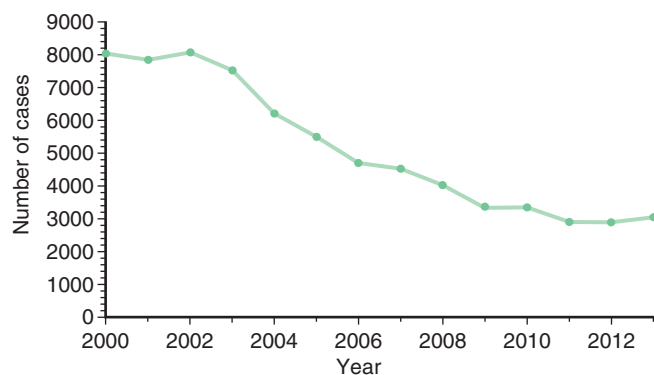

Source: National Notifiable Diseases Surveillance System (NNDSS)

FIG 10.2 Decreased incidence of Hepatitis B in the U.S.

sexual or parenteral contact. Hepatitis B is common in injection drug users, heterosexual persons with multiple sexual partners, and men who have sex with men. Blood transfusion and plasma products are now rarely infectious for hepatitis B because of the institution of routine screening of blood donations for hepatitis B surface antigen (HBsAg) and antibody to hepatitis B core antigen (HBcAg), anti-HBc (IgG antibody). Maternal–infant spread of hepatitis B is another important mode of transmission not only in endemic areas of the world but also in the United States among immigrants from these endemic areas. Routine screening of pregnant women and prophylaxis of newborns are now recommended. Intrafamilial spread of hepatitis B also can occur, although the mode of spread in this situation is not well defined. Unfortunately, lack of attention to standard (formerly universal) precautions and aseptic technique, especially the cleaning of shared medical devices, remains an important root cause of small outbreaks and sporadic cases of acute hepatitis B.^{1,6,7,18}

Pathophysiology and Complications

Hepatitis B virus is a double-shelled, enveloped DNA virus belonging to the family Hepadnaviridae (genus *Orthohepadnavirus*). The viral genome consists of partially double-stranded DNA, is 3.2 kb in length, and possesses four partially overlapping open reading frames that encode the genes for HBsAg (*S* gene), HBcAg (*C* gene), HBV polymerase (*P* gene), and a small protein, HBxAg, that seems to have transactivating functions (*X* gene). The virus infects only humans and higher apes and replicates predominantly in hepatocytes and perhaps to a lesser extent in stem cells in the pancreas, bone marrow, and spleen. The clinical course of hepatitis B with serologic markers is depicted in Fig. 10.3. During both acute and chronic infection, large amounts of HBsAg are detectable

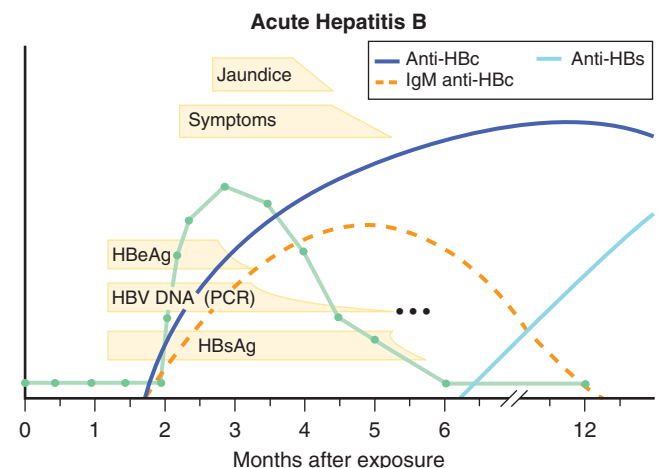

FIG 10.3 Serologic course of acute hepatitis B. HBc, Hepatitis B core; HBeAg, hepatitis B e antigen; HBs, hepatitis B surface; HBsAg, hepatitis B surface antigen; HBV, hepatitis B virus; PCR, polymerase chain reaction. (From Goldman L, Ausiello D, editors: *Cecil textbook of medicine*, ed 23, Philadelphia, 2008, Saunders.)

in serum, mostly in the form of incomplete 20-nm virus-like spherical and tubular particles. Persons who produce large amounts of HBV in serum typically also produce HBeAg, making HBeAg a surrogate marker for high levels of viral replication.^{1,3a,18}

Clinical Presentation

The typical course of acute, self-limited hepatitis B begins with an incubation period of 30 to 150 days (mean, 75 days). During the incubation period, HBsAg, HBeAg, and HBV DNA (see Fig. 10.3) become detectable in serum and rise to high titers, with the virus reaching titers of 10^8 to 10^{11} virions/mL. By the onset of symptoms, anti-HBc rises, and serum aminotransferase levels are elevated. Jaundice appears in one third of adults with hepatitis B and in a lesser proportion of children. Generally, HBV DNA and HBeAg begin to fall at the onset of illness and may be undetectable at the time of peak clinical illness. HBsAg becomes undetectable, and anti-HBs appears during recovery, several weeks to months after loss of HBsAg. Anti-HBs is a long-lasting antibody that is associated with immunity.^{1,3a,17,18}

Laboratory and Diagnostic Findings

The diagnosis of acute hepatitis B can be made on the basis of finding HBsAg in the serum of a patient with the clinical and biochemical features of acute hepatitis. HBsAg also may be present as a result of chronic hepatitis B or the carrier state. Also, a patient with acute hepatitis and HBsAg in serum may have chronic hepatitis and a superimposed form of acute injury, such as acute hepatitis A or D or drug-induced liver disease. Testing for IgM anti-HBc (IgG antibody) is therefore helpful because this antibody arises early and is lost within 6 to 12 months of the onset of illness. Testing for HBeAg, anti-HBe, HBV DNA, and anti-HBs generally is not helpful in the diagnosis of hepatitis B but may be valuable in assessing prognosis.^{1,3a,17,18} Persons who remain HBV DNA or HBeAg positive (or both) at 6 weeks after the onset of symptoms are likely to be developing chronic hepatitis B. Loss of HBeAg or HBV DNA is a favorable serologic finding. Similarly, loss of HBsAg plus the development of anti-HBs denotes recovery.^{1,3a,17,18}

Hepatitis B also is an important cause of fulminant hepatitis. Factors associated with severe outcomes of acute hepatitis B include advanced age, female sex, and perhaps certain strains of virus. Some variants of HBV lack the ability to produce HBeAg because of a mutation in the precore region of the viral genome. These precore or HBeAg-negative mutants are associated with atypical forms of acute and chronic hepatitis B. Several clusters of severe or fulminant hepatitis B have been associated with infection with the HBeAg-negative forms of virus.^{1,3a,17,18}

Medical Management

Vaccination against HBV is recommended for all newborns, children, and adolescents, as well as adults at risk for

acquiring HBV, including health care and public safety workers with exposure to blood, injection drug users, men who have sex with men, persons at risk for sexually transmitted infections (STIs), people traveling internationally to endemic regions, and persons with close contact with patients who have chronic hepatitis B. Two formulations of HBV vaccine are available in the United States; both are made by recombinant techniques using cloned HBV S gene expressed in *Saccharomyces cerevisiae*. For adults, the recommended regimen is three injections of 1.0 mL (20 µg of Energix-B [GlaxoSmithKline]^{1,3a,12} or 10 µg of Recombivax HB [Merck]) given intramuscularly in the deltoid muscle at 0, 1, and 6 months. Prevacination screening for anti-HBs is not recommended except for adults in high-risk groups (e.g., persons born in endemic countries, injection drug users, men who have sex with men, and HIV-infected persons). Postvaccination testing for anti-HBs to document seroconversion is not recommended routinely except in persons whose subsequent clinical management depends on knowledge of their immune status, particularly health care and public safety workers. At present, booster doses are not recommended but may be appropriate for persons at high risk if titers of anti-HBs fall below what is considered protective (10 IU/mL).^{1,3a,12}

Postexposure prophylaxis with HBIG is recommended at birth for infants born to infected mothers and for persons with percutaneous exposure to a patient with hepatitis B. A single dose of HBIG (0.5 mL in newborns of infected mothers and 0.06 mL/kg in other settings and in adults) should be given as soon as possible after exposure, and HBV vaccination should be started immediately. HBIG is unlikely to provide benefit of the time because exposure is longer than 14 days; vaccine alone can be used in these circumstances. For patients who have had sexual or household contact with a person who has chronic hepatitis B, vaccination alone is appropriate; HBIG is recommended in addition for sexual exposure to a person with acute hepatitis B.^{1,3a,16}

The use of antiviral therapy for acute hepatitis B is controversial. Regimens of interferon alfa and lamivudine are established therapies for chronic hepatitis B, but they have not been adequately evaluated for acute infection. In a small study, interferon alfa did not decrease the rate of chronicity or speed recovery. Uncontrolled observations with use of lamivudine in patients with fulminant and severe hepatitis B, however, suggest that this therapy may ameliorate the course of infection. Because of the safety of lamivudine therapy and the unpredictable and potentially serious outcome with severe cases of acute hepatitis B, therapy with lamivudine (100 mg/day until the disease has resolved and results of HBsAg testing have become negative) is prudent for patients with signs or symptoms of fulminant liver disease (rising prothrombin time, severe jaundice), particularly if high levels of HBV DNA are present.^{1,3a,12} Management of patients with acute hepatitis B also should focus on avoidance of further

hepatic injury and prophylaxis of contacts. Patients should be monitored by repeat testing for HBsAg and alanine aminotransferase levels 3 to 6 months later to determine whether chronic hepatitis B has developed.^{1,3a,12} Recently, entecavir plus tenofovir combination therapy has shown benefit in treating patients with multidrug-resistant chronic hepatitis B.²⁰

Chronic hepatitis B develops in 2% to 7% of adults infected with HBV, more commonly in men and in immunosuppressed persons. The risk of chronic infection also correlates with age. It occurs in 90% of newborns infected with HBV and approximately 30% of infants but in fewer than 10% of adults. Chronic hepatitis B is still the third or fourth most common cause of cirrhosis in the United States and is an important cause of liver cancer.^{1,3a,12}

HEPATITIS C

Epidemiology

Approximately 30,000 persons per year in the United States were infected with hepatitis C in 2013 representing an incidence of 0.7 per 100,000 people. Approximately 3.2 million people in the United States have chronic HCV infection. Hepatitis C has a high potential to become a chronic liver problem in approximately 85% of people infected with the virus resulting in more than 3 million chronic hepatitis C cases in the United States.^{1,3a,6,9,18} Hepatitis C is spread predominantly by the parenteral route. There is presently no vaccine for hepatitis C. For all these reasons, hepatitis C is the most significant infectious condition of concern to dental health care professionals.

At highest risk for contracting this disease are injection drug users and persons with multiple parenteral exposures. Sexual transmission of hepatitis C is uncommon. Prospective follow-up evaluation of spouses and sexual partners of patients with chronic hepatitis C shows the risk for sexual transmission to be low (<1% per year of exposure). Maternal–infant spread occurs in approximately 5% of cases, usually in infants whose mothers have high levels of HCV RNA in serum and have experienced a protracted delivery or early rupture of membranes. Other potential sources of HCV are needlestick accidents and either contamination or inadequate sterilization of reusable needles and syringes. There remain, however, many persons with chronic hepatitis C who were infected with the virus by these means in the past. Current studies of acute hepatitis C indicate that more than 60% of cases are attributable to injection drug use; 15% to 20% to sexual exposure (usually involving multiple sexual partners); and only a small proportion to maternal–infant spread, needlestick accidents, and iatrogenic causes. Approximately 10% of cases are not associated with any history of potential exposure and remain unexplained.^{1,3a,6,9,18,21}

Pathophysiology and Complications

Hepatitis C virus is an RNA virus that belongs to the family Flaviviridae (genus *Hepacivirus*). HCV originally

was identified by molecular techniques, and the virus has not been well visualized. HCV probably circulates as a double-shelled enveloped virus, 50 to 60 nm in diameter. The genome is a positive-stranded RNA molecule; it is approximately 9.6 kb in length and contains a single large open reading frame encoding a large polyprotein that is posttranslationally modified into three structural and several nonstructural polypeptides. The structural proteins include two highly variable envelope antigens, E1 and E2, and the relatively conserved nucleocapsid protein C. HCV replicates largely in the liver and is detectable in serum in titers of 10^5 to 10^7 virions/mL during acute and chronic infection.^{1,3a,6,9,18,21} Aside from the obvious significant problems of chronic liver disease, liver failure, and hepatocellular carcinoma, hepatitis C also increases the risk of chronic kidney disease (CKD, see Chapter 12).^{21,22}

Clinical Presentation

The clinical course of acute hepatitis C (Fig. 10.4) begins with an incubation period that ranges from 15 to 120 days (mean, 50 days). During the incubation period, often within 1 to 2 weeks of exposure, HCV RNA can be detected by sensitive assays such as those based on reverse transcriptase–polymerase chain reaction (PCR). HCV RNA persists until well into the clinical course of disease. Antibody to HCV (anti-HCV) arises late in the course of acute hepatitis C and may not be present at the time of onset of symptoms and serum aminotransferase elevations. If the hepatitis is self-limited, HCV RNA soon becomes undetectable in serum; in this situation, titers of anti-HCV generally are modest and eventually may fall to undetectable levels as well.^{1,3a,6,9,18,21}

Laboratory and Diagnostic Findings

The diagnosis of acute hepatitis C generally is based on detection of anti-HCV in serum in a patient with the

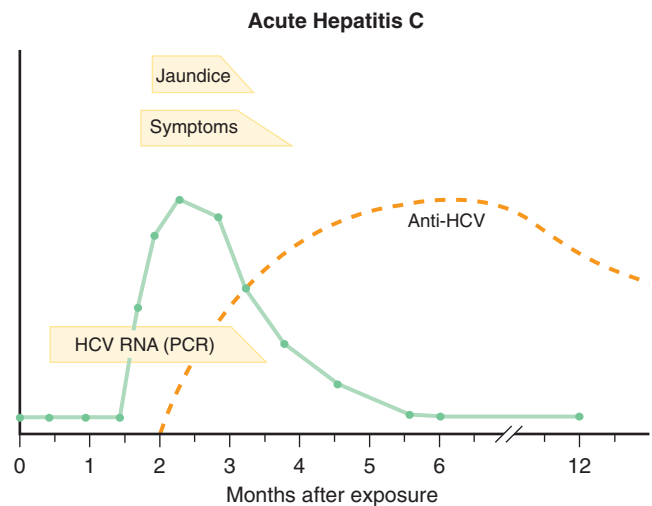

FIG 10.4 Serologic course of acute hepatitis C. HCV, Hepatitis C virus; PCR, polymerase chain reaction. (From Goldman L, Ausiello D, editors: *Cecil textbook of medicine*, ed 23, Philadelphia, 2008, Saunders.)

TABLE 10.3 Laboratory Criteria for the Diagnosis of Hepatitis C

<p>One or more of the following three criteria:</p> <ul style="list-style-type: none"> • Antibodies to HCV (anti-HCV) screening test positive with a signal-to-cutoff ratio predictive of a true positive as determined for the particular assay as defined by the CDC (signal to cut-off ratios: http://www.cdc.gov/hepatitis/HCV/LabTesting.htm)* or • HCV RIBA positive or • NAT for HCV RNA positive (including qualitative, quantitative, or genotype testing) <p>And, if done, meets the following two criteria:</p> <ul style="list-style-type: none"> • Absence of IgM antibody to HAV (if done) (IgM anti-HAV) and • Absence of IgM anti-HBc (if done)
--

*A documented negative HCV antibody laboratory test result followed within 6 months by a positive test result (as described in the laboratory criteria for diagnosis) does not require an acute clinical presentation to meet the surveillance case definition.

Laboratory criteria for the diagnosis of HCV: <http://www.cdc.gov/hepatitis/HCV/Labtesting.htm>. 2015.

CDC, Centers for Disease Control and Prevention; HAV, hepatitis A virus; HCV, hepatitis C virus; NAT, nucleic acid test; RIBA, recombinant immunoblot assay.

clinical and biochemical features of acute hepatitis. The diagnostic criteria for Hep C is detailed in [Table 10.3](#). The clinical course of hepatitis C with serologic markers is depicted in [Fig. 10.4](#). In some patients, however, detectable levels of anti-HCV do not develop until weeks or months after the onset of illness, so retesting for anti-HCV during convalescence or direct tests for HCV RNA are necessary to exclude the diagnosis of acute hepatitis C in a patient who tests negative for all serologic markers. Several commercial tests for HCV RNA are now licensed and are reliable in detecting HCV RNA at levels greater than 100 copies/mL. Tests that quantify the HCV RNA level also are available, but measuring viral levels is not clinically useful in diagnosis or monitoring of acute hepatitis C.^{1,3a,6,9,18,21}

Medical Management

At present, there are no means of prevention of hepatitis C other than avoidance of high-risk behaviors and appropriate use of standard precautions. There is no vaccine. Injection drug use is currently the most common cause of newly acquired cases of hepatitis C. In this regard, needle exchange programs and education regarding the risks of drug use, including intranasal cocaine, and the risk of transmission from shared injection equipment are important.^{1,3a,6,9,18,21}

Accidental needlestick exposure is perhaps the most frequent issue in prevention of transmission. At present, neither immune globulin nor preemptive therapy with antiviral agents or interferon is recommended in this situation. Monitoring by means of determination of aminotransferase levels and HCV RNA and anti-HCV testing (at baseline and again at 1 and 6 months after exposure) is appropriate. This approach allows for early intervention and treatment^{1,3a,6,9,18,21} ([Table 10.4](#)).

Therapy with peginterferon alfa and ribavirin^{1,21} has been shown to be beneficial in chronic hepatitis C; such therapy leads to sustained clearance of virus and resolution of disease in slightly more than 50% of cases. The role of therapy during acute infection is still unresolved. Because acute disease progresses to chronic infection in 50% to 85% of patients, the issue of early therapy often arises. Several studies have now documented that more than 90% of patients with acute hepatitis C treated with peginterferon with or without ribavirin for 24 weeks experience resolution of disease and sustained loss of HCV RNA.^{1,21,23,24} The possible roles of HCV genotyping in guiding therapy and limiting therapy to 12 to 16 weeks in patients who become seronegative for HCV RNA within 4 weeks of starting therapy are currently under investigation.^{1,21,23,24} Combinations of antiviral agents seem to be the most promising treatment of hepatitis C. The addition of boceprevir to standard therapy for HCV with peginterferon–ribavirin significantly increased the response in previously untreated adults with HCV infection.^{1,21,23,24}

Sofosbuvir and velpatasvir have demonstrated superior viral control as well.

Chronic HCV genotype-1 infection has been effective in clinical trials with ledipasvir and sofosbuvir as has grazoprevir plus elbasvir in treatment-naïve and treatment-experienced patients with hepatitis C. Additionally, simeprevir plus sofosbuvir in HCV genotype 1-infected patients has shown benefit, although there is a possibility of long-term recurrence with some of these therapies.²⁵⁻²⁸

The major complication of acute hepatitis C is the development of chronic hepatitis. The clinical course depicted in [Fig. 10.4](#) is not typical because hepatitis C does not resolve in 50% to 85% of cases but rather progresses to chronic infection. In this situation, HCV RNA remains detectable, and aminotransferase levels generally remain elevated, often in a fluctuating pattern. In some instances, aminotransferase levels become normal despite persistence of viremia. Other complications include the development of immune complex phenomena and cryoglobulinemia, although these complications are more typical of chronic disease. Fulminant hepatitis resulting from HCV is rare; in several large surveys of acute liver failure, none of the cases could be attributed to HCV.^{1,3a,21}

HEPATITIS D

Epidemiology

Hepatitis D is linked to hepatitis B, and consequently its epidemiology is similar. HDV can be spread by the parenteral route and through sexual contact. People at greatest risk are chronic carriers of hepatitis B and persons who have repeated parenteral exposures. In the United States and Western Europe, delta hepatitis is most common in injection drug users and, before routine screening of blood donations, recipients of blood products, including persons with hemophilia and thalassemia. Delta

TABLE 10.4 Recommendations for Management After Accidental Exposure to Blood of a Person Infected With Hepatitis Virus

Infectivity Status of Source Person	Unvaccinated HCW	Vaccinated HCW,* Known Responder	Vaccinated HCW, Known Nonreceptor	Vaccinated HCW, Response Unknown
HBsAg positive	1 dose of HBIG (0.06 mL/kg IM) as soon as possible (preferably within 24 hours) + initiate hepatitis B vaccine	No treatment	Administer one dose of HBIG + hepatitis B vaccine <i>or</i> two doses of HBIG, with second dose 1 month after the first	Test exposed worked for anti-HBsAg; with inadequate response (<10 mU/mL), one dose of HBIG + hepatitis B vaccine booster dose
HBsAg negative	Initiate hepatitis B vaccine series	No treatment	No treatment	No treatment
If unknown, not tested	Initiate hepatitis B vaccine series	No treatment	If known high-risk source, consider treating as for HBsAg-positive source	Test exposed** worked for anti-HBsAg; with inadequate response, initiate revaccination

**After a percutaneous or permucosal exposure, the blood of the source person (and of the exposed person) should be tested for HBsAg, anti-hepatitis C virus (HCV), and human immunodeficiency virus antibody. Testing should be done in accordance with state laws and where appropriate pretest and posttest counseling are available. Currently, no treatment is available or recommended for occupational postexposure to HCV, hepatitis E virus, and non-A-E hepatitis viruses.

Data from Centers for Disease Control: Recommendations for follow-up of health-care workers after occupational exposure to hepatitis C virus, *MMWR Morb Mortal Wkly Rep* 46:603-606, 1997.

Also, current data suggest that a hepatitis A virus (HAV) percutaneous or permucosal exposure in an occupational setting is unlikely to result in transmission of HAV. Unvaccinated persons (younger than 2 years of age) recently exposed to HAV are advised to receive a single 0.02-mL/kg intramuscular (IM) injection of immune globulin according to the Advisory Committee on Immunization Practices recommendations.

Data from Centers for Disease Control and Prevention: Prevention of hepatitis A through active or passive immunization: recommendation of the Advisory Committee on Immunization Practices, *MMWR Recomm Rep* 48[RR-12]:1-31, 1999.

*Exposed worker vaccinated against hepatitis B virus.

HBIG, Hepatitis B immune globulin; HBsAg, hepatitis B surface antigen; HCW, health care worker.

Data from Centers for Disease Control and Prevention: Immunization of health-care workers: recommendations of the Advisory Committee on Immunization Practices (ACIP) and the Hospital Infection Control Practices Advisory Committee (HICPAC), *MMWR Recomm Rep* 46(RR-18):1-42, 1997.

hepatitis is endemic in the Amazon basin and central Africa and is common in some European and Mediterranean countries, including southern Italy, Greece, and eastern Europe.^{1,3a}

Pathophysiology and Complications

The hepatitis delta virus is a unique RNA virus that requires HBV for replication. The viral genome is a short, 1.7-kb circular single-stranded molecule of RNA that has a single open reading frame and a highly conserved, nontranslated region that resembles the self-replicating element of viroids. The single open reading frame encodes delta antigen, and RNA editing can vary the size of the molecule to produce either a small (195 amino acids) or large (214 amino acids) delta antigen. The small delta antigen promotes the replication of HDV RNA; the large delta antigen promotes viral assembly and secretion into serum as the mature 36-nm delta viral particle.^{1,3a}

Clinical Presentation

Delta hepatitis occurs in two clinical patterns termed *coinfection* and *superinfection*. Delta coinfection is the simultaneous occurrence of acute HDV and acute HBV infections. Clinically and serologically, it resembles acute hepatitis B but may manifest a second elevation in aminotransferase levels associated with the period of delta virus replication. The diagnosis of acute delta coinfection

can be made in patients with clinical features of acute hepatitis who have HBsAg, anti-HDV, and IgM anti-HBc in serum. Immunoassays for anti-HDV are commercially available and reliable, although the antibody may appear late during the illness. In patients suspected of having delta hepatitis, repeat testing for anti-HDV during convalescence is appropriate.^{1,3a,7}

Laboratory and Diagnostic Findings

Acute delta superinfection is the occurrence of acute HDV infection in a person with chronic hepatitis B or the HBsAg carrier state. The diagnosis of superinfection can be made in a patient with clinical features of acute hepatitis who has HBsAg and anti-HDV but no IgM anti-HBc in serum. Superinfection with HDV is more frequent than coinfection and is far more likely to lead to chronic delta hepatitis. Other tests that are helpful in making the diagnosis of ongoing HDV infection are determinations of serum HDV RNA (detectable by PCR assay) and HDV antigen (detectable by immunoblot analysis); both of these tests are currently research assays and not standardized. Delta antigen also can be detected readily in liver biopsy specimens with immunohistochemical staining.^{1,3a,7}

Medical Management

Delta hepatitis can be prevented by preventing hepatitis B. The severity of delta hepatitis is another compelling

rationale for routine hepatitis B vaccination in areas of the world where delta hepatitis is endemic. There are no means of prevention of delta hepatitis in a person who is already an HBsAg carrier; in this situation, avoidance of further exposure is important.

No specific therapies are available for acute delta hepatitis. Lamivudine and other anti-HBV agents are ineffective against HDV replication. Most cases of acute coinfection resolve; patients with superinfection should be treated when it is clear that chronic delta hepatitis has supervened.^{1,3a,7}

Delta hepatitis tends to be more severe than hepatitis B alone and is more likely to lead to fulminant hepatitis and to cause severe chronic hepatitis and ultimately cirrhosis.^{1,3a,7}

HEPATITIS E

Epidemiology

Hepatitis E is responsible for epidemic and endemic forms of non-A, non-B hepatitis that occur in less developed areas of the world. Large outbreaks have been described from India, Pakistan, China, northern and central Africa, and Central America. In studies from India and Egypt, hepatitis E has accounted for a high proportion of cases of sporadic acute hepatitis. In the United States and Western Europe, hepatitis E is rare, with most cases being imported or caused by zoonotic spread from swine or rats that harbor a similar virus. HEV is spread by the fecal–oral route, and most cases can be traced to exposure to contaminated water under poor hygienic conditions. Hepatitis E seems to be less contagious than hepatitis A, the other form of infectious hepatitis, and secondary cases are rare.^{1,3a,7}

Pathophysiology and Complications

Hepatitis E virus is a small nonenveloped, single-stranded RNA virus that is currently unclassified. The viral genome is 7.5 kb in length and encodes three open reading frames—the first, ORF1, for the nonstructural proteins responsible for viral replication; the second, ORF2, for the capsid protein (HEV antigen); and the third, ORF3, for a short protein of unknown function. The virus and HEV antigen can be detected in hepatocytes during acute infection. The highest levels of virus are detectable in stool during the incubation period of the disease. Viruses similar to HEV are found in other species, and strains found in domesticated swine may be infectious in humans.^{1,3a,7}

Clinical Presentation

The clinical course of hepatitis E resembles that of other forms of hepatitis. The incubation period is 15 to 60 days (mean, 35 days). The disease frequently is cholestatic, with prominence of bilirubin and alkaline phosphatase elevations.^{1-3a,7} Hepatitis E also tends to be more severe than other forms of epidemic jaundice, with a fatality

rate of 1% to 2% and a particularly high rate of acute liver failure in pregnant women. HEV virions and antigen can be detected in stool and liver during the incubation period and early symptomatic phase, but these tests are not practical methods of diagnosis. ELISAs for IgM and IgG antibody to HEV (anti-HEV) have been developed and are reactive in at least 90% of patients at the onset of clinical illness. These tests are neither generally available nor standardized, however. In addition, anti-HEV is found in 1% to 2% of the normal population, which may represent resolved subclinical cases of hepatitis E acquired during travel or as a result of exposure to livestock or other infected animals.^{1-3a,7}

Laboratory and Diagnostic Findings

The diagnosis of hepatitis E should be considered in a patient with acute hepatitis who has recently traveled to an endemic area, particularly if tests for other forms of hepatitis are nonreactive. Detection of anti-HEV, particularly of the IgM subclass, is sufficient to make the diagnosis in this situation.^{1-3a,7}

There are no known means of prevention or treatment of hepatitis E. Immune globulin, even when prepared from plasma obtained from populations with a high rate of hepatitis E, does not seem to be effective. No specific modalities of treatment have been evaluated. Travelers (particularly pregnant women) to areas of the world where hepatitis E is endemic should be cautioned regarding drinking water and uncooked food. Recombinant vaccines against HEV have been developed and shown to be effective in animal models of hepatitis E. Efficacy trials of an HEV vaccine are now under way in endemic areas.^{1-3a}

The diagnostic approach to the patient with clinical features of acute hepatitis begins with a careful history for risk factors and possible exposure; for medication use, including herbal and over-the-counter drugs; and for alcohol use. The onset and progression of symptoms may give clues to the presence of other causes of liver or biliary tract disease, such as alcohol abuse or gallstones. Biochemical laboratory tests, including determinations of serum bilirubin, alanine and aspartate aminotransferases (ALT and AST), alkaline phosphatase (reported variously as ALP or alk phos), lactate dehydrogenase, albumin, and prothrombin time and a complete blood cell count (CBC), are valuable in defining whether the clinical picture is typical of acute hepatitis (high aminotransferases, normal or modest elevations in alkaline phosphatase and lactate dehydrogenase) or resembles that in obstructive jaundice or alcoholic liver disease.^{1-3a} In atypical cases, an anti-nuclear antibody assay to evaluate for autoimmune hepatitis and a Venereal Disease Research Laboratory (VDRL) test to exclude secondary syphilis are needed. The presence of fever and atypical lymphocytosis points to mononucleosis. The presence of hemolysis should suggest Wilson disease. Serologic tests that are helpful in all cases of acute hepatitis are shown in [Table 10.2](#).^{1-3a}

HEPATITIS NON–A–E

Epidemiology

Cases of acute hepatitis that appear to be viral in etiology but cannot be attributed to any known virus are called *hepatitis non–A–E*. Various candidate viruses have been reported in association with this disease, including paramyxoviruses, togaviruses, and flaviviruses (GB virus C [GBV-C], hepatitis G virus, and TT virus), but none has been clearly linked to the clinical entity. In serologic surveys of cases of acute hepatitis in Western countries, 2% to 20% of cases cannot be attributed to any of the five known hepatitis viruses.^{1-3a}

Clinical Presentation

The clinical features of non–A–E hepatitis are similar to those of recognized forms of acute hepatitis. In most cases of non–A–E hepatitis, no clear source of exposure can be identified. Rare cases have been reported after blood transfusion. The absence of typical risk factors for viral hepatitis suggests that in some instances, non–A–E hepatitis may be due to nonviral causes, such as an autoimmune process, environmental exposure, or drugs.^{1-3a}

Laboratory and Diagnostic Findings

Non–A–E hepatitis is a diagnosis of exclusion.^{1-3a}

Medical Management

There are no means of either treatment or prevention of non–A–E hepatitis.

The syndrome of non–A–E hepatitis has been particularly associated with the complications of acute liver failure and aplastic anemia. Hepatitis non–A–E is a more common cause of fulminant hepatic failure than both hepatitis A and hepatitis B combined and often accounts for 30% to 40% of cases. Chronic hepatitis develops in approximately one third of patients with non–A–E hepatitis, and cirrhosis ultimately develops in a small percentage.^{1-3a}

Little to no risk exists for transmission of HAV, HEV, and non–A–E hepatitis viruses from occupational exposure of dental health care workers to persons infected with these viruses. By contrast, risk for transmission of HBV is well recognized, and a lesser risk is present for HCV infection after occupational exposure to infected blood or body fluids containing infected blood. HCV is less infectious and less efficient in transmission than HBV. After percutaneous or other sharps injury in health care workers involving exposure to contaminated blood, the risk of contracting HBV infection is reported to range from 6% to 30%, with potential infectiousness correlating with presence of HBeAg in the serum (i.e., serum with HBeAg and HBsAg may be 10 times more infectious than serum with HBsAg alone). Recommendations for post-exposure are presented in [Table 10.4](#). Moreover, HBV can survive for at least 1 week in dried blood on environmental surfaces and contaminated needles and instruments. By contrast, the seroconversion rate for accidental

blood exposure to HCV is between 2% and 8%. By comparison, the risk of contracting HIV infection after a percutaneous or other sharps injury is 0.3%.^{2,11}

The role of saliva in HBV or HCV transmission, except by percutaneous or permucosal routes, does not appear to be significant. During the past several decades, HBV transmission has been documented to occur from dental health care workers to dental patients.⁹ Transmission of HCV from dental health care worker to patient has not been reported, but cardiac surgeons are recognized to have transferred this virus to several of their patients.^{2,11}

Pathophysiology and Complications

Icterus (jaundice), the accumulation of bilirubin in the plasma, epithelium, and urine, is associated with hepatitis in approximately 70% of cases of HAV, approximately 30% of cases of HBV infection, and approximately 25% of cases of HCV and HEV. Bilirubin is a degradation product of hemoglobin and one of the major constituents of bile, to which it confers the characteristic yellowish color. Bilirubin normally is transported to the liver by way of the plasma. In the liver, it conjugates with glucuronic acid, and then it is excreted into the intestine, where it aids in the emulsification of fats and stimulates peristalsis.^{1,3a} In the presence of liver disease, bilirubin tends to accumulate in the plasma as a consequence of decreased liver metabolism and transport. Jaundice usually becomes clinically apparent when the plasma level of bilirubin approaches 2.5 mg/100 mL (normal is less than 1 mg/100 mL). If the plasma bilirubin does not reach this level, the patient is anicteric (without jaundice), thus explaining nonicteric hepatitis.^{1,3a} Most cases of viral hepatitis, especially types A and E, resolve without any complications. HBV, HCV, and HDV can persist and replicate in the liver when the virus is not completely cleared from the organ. Potential outcomes with hepatitis include recovery, persistent infection (or carrier state), dual infection, chronic active hepatitis, fulminant hepatitis, cirrhosis, hepatocellular carcinoma, and death. Dual infections and the chronic consumption of alcohol lead to more severe disease. Approximately 16,000 people die annually because of complications related to hepatitis infection.^{1,3a,7}

Fulminant Hepatitis. A serious complication of acute viral hepatitis is fulminant hepatitis, characterized by massive hepatocellular destruction and a mortality rate of approximately 80%. The condition occurs more commonly among older adults and patients with chronic liver disease. Coinfection or superinfection with HBV and HDV or infection by a single hepatitis virus can cause fulminant disease. Mutant strains of these viruses have been proposed to be causative. In the United States, each year more than 100 persons die of fulminant hepatitis A and hepatitis E, and approximately 350 persons die of HBV-HDV-associated fulminant disease. HCV rarely causes fulminant hepatitis.^{1,3a,7}

Chronic Infection. Chronic infection (carrier state) is characterized by the persistence of low levels of virus in the liver and serum viral antigens (HBsAg, HBeAg, and HCVAg) for longer than 6 months without signs of liver disease. Persons with this condition potentially are infectious to others. The rate of carrier establishment varies depending on the virus, age, and health of the patient.^{1,3a} For example, approximately 50% to 90% of infants, 25% of children, and 6% to 10% of adults infected with HBV become carriers. By contrast, 70% to 90% of adults infected with HCV develop a persistent carrier state.^{1,3a} With both viruses, men and immunosuppressed persons are more commonly affected. Approximately 0.1% to 0.5% of the general population in the United States (>4 million persons) are carriers of HBV, HCV, or both, and 5% to 15% of the populations of China, Southeast Asia, sub-Saharan Africa, most Pacific Islands, and the Amazon Basin are HBV carriers.^{1,3a,6,7} This marked difference reflects the endemicity of hepatitis B in these latter countries.

The carrier rate among dentists in the United States has decreased, but the risk is still estimated to be 3 to 10 times that in the general population. The highest HCV carrier rates (20%) are found among injection drug users and persons with hemophilia. Health care workers show an approximately 1% to 2% prevalence. The lowest rates of anti-HCV are found among blood donors, with about 0.5% to 1.0% being positive. Approximately 2% to 5% of acute coinfections of HBV and HDV result in chronic infections. Superinfections are more frequent than coinfections and result in a chronic carrier state in more than 70% of persons.^{1-3a,6,7} The carrier state may persist for decades or cause liver disease by progressing to chronic active hepatitis.

Chronic active hepatitis is characterized by active virus replication in the liver, HBsAg and HBeAg or HCVAg in the serum, signs and symptoms of chronic liver disease, persistent hepatic cellular necrosis, and elevation of liver enzymes for longer than 6 months. Approximately 3% to 5% of patients infected with HBV, 25% of HBV carriers, and 40% to 50% of those infected with HCV develop chronic active hepatitis.^{22,23} Worldwide approximately 500 million people are infected with HBV or HCV, accounting for more than 1 million deaths per year. In the United States, approximately 1.3 million people (0.4%) have chronic HBV, and approximately 3.2 million people (1.2%) have chronic HCV.^{1,3a,6,7} HBV- and HCV-related chronic liver destruction and the resulting fibrosis lead to cirrhosis in approximately 20% of cases of chronic hepatitis. Approximately 1% to 5% of these patients develop primary hepatocellular carcinoma. An estimated 4000 persons die each year from HBV-related cirrhosis, 10,000 die from HCV-related cirrhosis, and more than 800 die from HBV- and HCV-related liver cancer.^{1,3a,6,7} The correlation with liver cancer is 30 to 100 times stronger for chronic carriers than for uninfected persons and is particularly strong in some selected Asian populations.^{3a,18}

Liver cancer, primarily hepatocellular carcinoma, is the third leading cause of death from cancer worldwide and the ninth leading cause of cancer deaths in the United States.^{3a,6,7,9,21} Chronic HBV and HCV infections account for an estimated 78% of global cases of hepatocellular carcinoma. The average annual incidence rate of hepatocellular carcinoma is approximately 3.0 per 100,000 persons and has increased significantly over the past 10 years.^{3a,6,7,9,21} The data demonstrate a continuation of long-term increases in incidence of hepatocellular carcinoma and persistent relevant racial or ethnic disparities.^{6,7,9} Development of viral hepatitis services, including screening with care referral for persons chronically infected with HBV or HCV, full implementation of vaccine-based strategies to eliminate hepatitis B, and improved public health surveillance, is needed to help reverse the trend in hepatocellular carcinoma.^{1,6,7,9}

Chronic infection with hepatitis C also increases the risk for the development or progression of CKD (see Chapter 12).²²

Clinical Presentation. After an incubation phase that varies with the infecting virus, approximately 10% of hepatitis A, 60% to 70% of hepatitis C, and 70% to 90% of hepatitis B cases are asymptomatic. When manifestations occur, the clinical features of acute viral hepatitis are similar and are discussed together. Many of the signs and symptoms are common to many viral illnesses and may be described as flulike. This clinical picture is especially characteristic of the early, or prodromal, phase. Patients classically exhibit three phases of acute illness.^{1,3a,6,9,21}

The *prodromal (preicteric) phase* usually precedes the onset of jaundice by 1 or 2 weeks and consists of abdominal pain, anorexia, intermittent nausea, vomiting, fatigue, myalgia, malaise, and fever. With hepatitis B, 5% to 10% of patients demonstrate serum sickness-like manifestations, including arthralgia or arthritis, rash, and angioedema.^{1,3a,6,9,21}

The *icteric phase* is heralded by the onset of clinical jaundice, manifested by a yellow-brown cast to the conjunctivae, skin, oral mucosa, and urine. Many of the nonspecific prodromal symptoms may subside, but gastrointestinal (GI) manifestations (e.g., anorexia, nausea, vomiting, right upper quadrant pain) may increase, especially early in this phase. Hepatomegaly and splenomegaly frequently are noted. This phase lasts 2 to 8 weeks and is part of the clinical course in at least 70% of patients infected with HAV, 30% of those acutely infected with HBV, and 25% to 30% of patients acutely infected with HCV.^{1,3a,6,9,21}

During the *convalescent or recovery (posticteric) phase*, symptoms disappear, but hepatomegaly and abnormal liver function values may persist for a variable period. This phase can last for weeks or months, with recovery times for hepatitis B and hepatitis C generally longer. The usual sequence is recovery (clinical and biochemical) within approximately 4 months after the onset of jaundice. HBV

infrequently is associated with clinical syndromes, including polyarteritis nodosa, glomerulonephritis, and leukocytoclastic vasculitis. Coagulopathy, encephalopathy, cerebral edema, and fulminant hepatitis are rare.^{1,3a,6,9,21} Chronic hepatitis is associated with liver abnormalities but often is asymptomatic for 10 to 30 years. Nonspecific symptoms of chronic hepatitis C (loss of weight, easy fatigue, sleep disorder, difficulty in concentrating, right upper quadrant pain, and liver tenderness) may not appear until hepatic fibrosis, cirrhosis, or hepatocellular carcinoma are present. The hepatic damage is caused by both the cytopathic effect of the virus and the inflammatory changes secondary to immune activation. Extrahepatic immunologic disorders associated with chronic HCV infection result from the production of autoantibodies and include immune complex–mediated disease (vasculitis, polyarteritis nodosa); autoimmune disorders (rheumatoid arthritis, glomerulonephritis, thrombocytopenic purpura, thyroiditis, pulmonary fibrosis); and two immunologic disorders, lichen planus and Sjögren-like syndrome (lymphocytic sialadenitis).^{1,3a,6,9,21} If these diseases or signs of advanced liver disease (bleeding esophageal varices, ascites, jaundice, spider angioma, dark urine) develop, testing for chronic hepatitis is recommended.^{1,3a,6,9,21} HDV infection often results in severe acute hepatitis or rapidly progressive chronic liver disease. Whereas coinfection usually results in transient and self-limiting disease, superinfection more often results in severe clinical disease, indicated by sudden exacerbation, in a chronic carrier of HBV.^{1,3a,6,9,21}

Laboratory Findings

Serologic testing is necessary to detect hepatitis B and C. The laboratory criteria for the diagnosis of hepatitis C are listed in [Table 10.3](#).

The standard battery of tests that are most helpful in assessing liver disease includes determinations of total and direct bilirubin; albumin; prothrombin time; and the serum enzymes ALT, AST, and alkaline phosphatase. Interpretation of these results in concert with careful history taking and a physical examination may suggest a specific type of liver injury, allowing a directed evaluation, risk assessment for surgical procedures, and estimation of prognosis.^{1,7} Bilirubin is a breakdown product of heme (ferroprotoporphyrin IX). Hyperbilirubinemia may be the result of overproduction of bilirubin through excessive breakdown of hemoglobin; impaired hepatocellular uptake, conjugation, or excretion of bilirubin; or regurgitation of unconjugated and conjugated bilirubin from damaged hepatocytes or bile ducts. The presence of conjunctival icterus suggests a total serum bilirubin level of at least 3.0 mg/dL.^{1,7}

Aminotransferases. The serum aminotransferases (also called transaminases), the most sensitive markers of acute hepatocellular injury, have been used to identify liver disease since the 1950s. ALT (formerly serum glutamate-pyruvate transaminase [SGPT]) and AST (formerly serum glutamate-oxaloacetate transaminase [SGOT]) catalyze

the transfer of the α -amino groups of alanine and l-aspartic acid, respectively, to the α -keto group of ketoglutaric acid. AST, present in cytosol and mitochondria, is widely distributed throughout the body; it is found, in order of decreasing concentration, in the liver, cardiac muscle, skeletal muscle, kidneys, brain, pancreas, lungs, leukocytes, and erythrocytes. Increases in serum values of the aminotransferases reflect either damage to tissues rich in these enzymes or changes in cell membrane permeability that allow ALT and AST to leak into serum; hepatocyte necrosis is not required for the release of aminotransferases, and the degree of elevation of the aminotransferases does not correlate with the extent of liver injury.^{1,7}

Alkaline Phosphatase. The term *alkaline phosphatase* applies generally to a group of isoenzymes distributed widely throughout the body. The isoenzymes of greatest clinical importance in adults are in the liver and bone because these organs are the major sources of serum alkaline phosphatase. Hepatobiliary disease leads to increased serum alkaline phosphatase levels through induced synthesis of the enzyme and leakage into the serum, a process mediated by bile acids.^{1,7} A low serum alkaline phosphatase level may be observed in patients with Wilson disease, especially those presenting with fulminant hepatitis and hemolysis, possibly because of reduced activity of the enzyme owing to displacement of the cofactor zinc by copper.^{1,3a,7,10} The serum transaminases, AST^{1,3a,7,10} and ALT,^{1,3a,7,10} are sensitive indicators of liver injury and acute viral hepatitis, with ALT being a more specific indicator. Also useful in the diagnosis of hepatitis are elevated levels of serum bilirubin, alkaline phosphatase (heat fraction), γ -glutamyl transpeptidase (GGT), and lactate dehydrogenase; an increased white blood cell count; and prolongation of the prothrombin time. Antigen-antibody serologic tests are required for identifying the viral agent and in distinguishing among acute, resolved, and chronic infections.^{1,3a,7,10}

PREVENTION

Prevention Through Active Immunization

The risk of viral hepatitis is reduced by receiving active immunization. At present, two vaccines are available for HAV, two vaccines are available for HBV, one vaccine (Twinrix) is available for combination hepatitis A and B, and one vaccine (Comvax) is available for hepatitis B and *Haemophilus influenzae* type b (in combination with *Neisseria meningitidis* OMPC) in infants. The hepatitis A vaccine was first approved for use in the United States in 1995. Harivax and Vaqta are the formalin-inactivated whole virus vaccines used specifically to prevent HAV infection. The HAV vaccines are safe, highly immunogenic, and recommended for patients 2 years of age and older.¹⁵

The vaccine originally was derived from pooled donor plasma; however, this form is no longer available. The two vaccines licensed for prevention of HBV infection (Engerix-B and Recombivax HB) are produced by

recombinant DNA technology. These vaccines are administered in three doses over a 6-month period and produce an effective antibody response in more than 90% of adults and 95% of infants, children, and adolescents. The conversion rate is based on data obtained for injections given in the deltoid muscle because injections administered in the buttocks resulted in development of effective antibody titers in only 81% of recipients. Adverse effects with all three vaccines include soreness at the injection site, fever, chills, flulike symptoms, arthralgia, and rarely neuropathy. No risk for development of viral infection in association with use of these vaccines, including the original plasma-derived vaccine, has been documented.^{6,16,18}

The duration of immunity and the need for booster doses remain controversial. Current information based on experience with the plasma-derived HBV indicates that immunity remains effective for more than 10 years. Current guidelines published by the Centers for Disease Control and Prevention (CDC) Advisory Committee on Immunization Practices recommend booster doses only for persons who did not respond to the primary vaccine series.^{6,9,16,18}

During the decade after vaccine licensure, vaccination of target populations of persons at high risk for contracting HBV infection became the accepted approach to prevention (Box 10.1). At the top of the list are health care workers, including dentists, for whom inoculation with the vaccine is strongly recommended. Implementation of a posttesting strategy is important for identifying persons who are nonresponders.^{6,9,16,18}

A strategy to interrupt HBV transmission in all age groups was developed in 1991 and updated in 1995. The current strategy includes (1) prevention of perinatal HBV

infection, (2) routine vaccination of all infants, and (3) vaccination of selected adolescents and adults not vaccinated as infants. Implementation of this strategy also eventually should control hepatitis D in parallel with control of hepatitis B.^{6,16,18}

Prevention Through Passive Immunization

Treatment of viral hepatitis can be accomplished by administering early postexposure immune globulins or postexposure hepatitis B vaccine (see earlier under “Prevention Through Active Immunization”). Immune serum globulin is derived from a pool of antibodies collected from human plasma that is free of HBsAg, HCV, and HIV. This sterile solution contains antibodies against both hepatitis A and hepatitis B. Another type of immune globulin is called *hepatitis B immune globulin* (HBIG). It is specially prepared from preselected plasma that is high in titers of anti-HBs. Administration of both immune globulin and HBIG is safe, but they interact adversely with live attenuated vaccines (i.e., measles, mumps, rubella [MMR] vaccine) if given within 5 months of each other.^{6,9,16,18}

TREATMENT

As with many viral diseases, therapy basically is palliative and supportive. Bedrest and fluids may be prescribed, especially during the acute phase. A nutritious and high-calorie diet is advised. Alcohol and drugs metabolized by the liver are not to be ingested. Viral antigen and ALT levels should be monitored for 6 months to determine whether the hepatitis is resolving. Chronic hepatitis rarely resolves spontaneously. Standard therapy for patients with chronic hepatitis is administration of interferon (alfa-2b) (3–10 million units given three times weekly for 6 months to 1 year). Treatment of chronic HCV until now has used two types of drugs in combination. One type, interferon, targets an infected person’s immune system, stimulating the immune system to attack the virus. The second type of drug, ribavirin (Rebetol, Copegus), interferes with the production of the ribonucleic acid (RNA) that makes up the genetic material of HCV. The genetic material of HCV is responsible for taking over the infected human cells and directing the cells to produce more virus, at the same time interfering with normal function of the cells. If the genetic material cannot be reproduced, no new virus forms, and the spread of virus to other cells in the body is halted. Unfortunately, however, existing virus remains. (The patient still is infected.)^{1,18-24}

Interferon therapy normalizes ALT levels in up to 17% of patients infected with HDV, 30% of those infected with HCV, and 40% of those infected with HBV and reduces the risk for development of hepatocellular carcinoma.^{1,18-24} Response is better when interferon is initiated early in the course of the disease. Treatment costs are high, and only 10% to 30% of patients achieve long-term remission. Adverse effects (fatigue, flulike symptoms, and

BOX 10.1 Persons at Substantial Risk for Hepatitis B Who Should Receive Vaccine

- Individuals with occupational risk
- Health care workers
- Public safety workers
- Clients and staff of institutions for developmentally disabled individuals
- Hemodialysis patients
- Recipients of certain blood products
- Household contacts and sex partners of HBV carriers
- Adoptees from countries where HBV infection is endemic
- International travelers
- Illicit drug users
- Sexually active homosexual and bisexual men (men who have sex with men)
- Sexually active heterosexual men and women (who have multiple partners)
- Inmates of long-term correctional facilities

HBV, Hepatitis B virus.

Data from the Centers for Disease Control and Prevention: *Hepatitis B information for health professionals*: <http://www.cdc.gov/hepatitis/HBV/index.htm>.

bone marrow suppression) are common, and up to 15% of patients experience significant side effects that result in the discontinuation of treatment. Treatment with peginterferon is standard and fairly effective.^{1,18-24} The addition of lamivudine (a nucleoside analogue active against HBV) or ribavirin (a guanosine analogue active against HCV) gains a virologic response in an additional 15% to 25%.^{1,18-24} Ribavirin (1000 mg/day) also is an effective agent for treatment but has many side effects and adverse interactions.^{1,11,18-24} More recent clinical trials have indicated that telaprevir, ledipasvir, and sofosbuvir are effective for treating hepatitis C that previously has been ineffectively treated with other agents.²⁶ Sofosbuvir and velpatasvir have also recently been used together and demonstrated efficacy in reducing viral load in patients with chronic hepatitis C.²⁵ The use of combination therapies (Viekera Pak containing ombitasvir, paritaprevir, and ritonavir) was approved in 2015 and has also shown effectiveness for chronic hepatitis C treatment.²⁸ Recent clinical trials (2015) have also demonstrated effectiveness of grazoprevir plus elbasvir for hepatitis C, particularly in patients with coexisting renal disease.²⁷

Depending on the severity of the liver damage (as determined by laboratory tests or liver biopsy, combination therapy is recommended.^{1,11,18-28} Corticosteroids usually are reserved for patients with fulminant hepatitis. Liver transplantation is a last resort for patients who develop cirrhosis (see [Chapter 21](#)).^{1,11}

DENTAL MANAGEMENT

Treatment Considerations in Specific Patient Groups

The identification of potential or actual carriers of HBV, HCV, and HDV is problematic because in most instances, carriers cannot be identified by history. The inability to identify potentially infectious patients extends to HIV infection and other STIs. Therefore, all patients with a history of viral hepatitis must be managed as though they were potentially infectious (see [Box 10.1](#)).

The recommendations for infection control practice in dentistry published by the CDC and the American Dental Association have become the standard of care to prevent cross-infection in dental practice (see [Appendix B](#)).²⁹ These organizations strongly recommend that all dental health care workers who provide patient care receive vaccination against HBV and implement standard precautions during the care of all dental patients. In addition, Occupational Safety and Health Administration (OSHA) standards require employers to offer hepatitis B vaccine for free to employees occupationally exposed to blood or other potentially infectious materials. No recommendations exist for immunization against the other hepatitis viruses.^{1,3b,9,16}

Patients With Active Hepatitis. No dental treatment other than urgent care (absolutely necessary work) should

be rendered for a patient with active hepatitis unless the patient has attained clinical and biochemical recovery ([Box 10.2](#)). Urgent care should be provided only in an isolated operator with strict adherence to standard precautions (see [Appendix B](#)). Aerosols should be minimized, and drugs that are metabolized in the liver should be avoided as much as possible ([Box 10.3](#)). If surgery is necessary, a preoperative prothrombin time and bleeding time should be obtained and abnormal results discussed with the physician. The dentist should refer patients who have acute hepatitis for medical diagnosis and treatment.^{4,5,8}

Patients With a History of Hepatitis. Most carriers of HBV, HCV, and HDV are unaware that they have had hepatitis. An explanation is that many cases of hepatitis B and hepatitis C apparently are mild, subclinical, and nonicteric. Such cases may be essentially asymptomatic or resemble a mild viral disease and therefore go undetected. Thus, the only practical method of protection from exposure to potential infection associated with providing dental care for persons with undiagnosed hepatitis or with other undetected infectious diseases is to adopt a strict program of clinical asepsis for all patients (see [Appendix B](#)). In addition, use of the hepatitis B vaccine further decreases the threat of hepatitis B infection. Inoculation of all dental personnel with hepatitis B vaccine is strongly urged.

For patients who provide a positive history of hepatitis, additional historical information occasionally can be of some help in determining the type of disease.^{4,5,8}

An additional aspect of a prudent approach to provision of clinical care for patients with a history of hepatitis of unknown type is to use the clinical laboratory to screen for the presence of HBsAg or anti-HCV. Such screening may be indicated even in persons who specifically indicate which type of hepatitis they had, because information provided in patient histories of this type is unreliable 50% of the time.^{4,5,8}

Patients at High Risk for Hepatitis B Virus or Hepatitis C Virus Infection. Several groups are at unusually high risk for HBV and HCV infection (see [Box 10.1](#)).^{1-5,9} Screening for HBsAg and anti-HCV is recommended in persons who fit into one or more of these categories unless they are already known to be seropositive. Even if a patient is found to be a carrier, no modifications in treatment approach theoretically would be necessary. Information derived from such screening may nevertheless be of benefit in certain situations. If a patient is found to be a carrier, this knowledge could be of extreme importance for the modification of lifestyle. In addition, the patient might have undetected chronic active hepatitis, which could lead to bleeding complications or drug metabolism problems.^{1-5,9} Finally, if an accidental needle-stick or puncture wound occurs during treatment and the dentist is not vaccinated (or antibody titer status is unknown), knowing whether the patient was HBsAg or HCV positive would be of extreme importance in

BOX 10.2 Dental Management Considerations in Patients With Liver Disease**P****Patient Evaluation and Risk Assessment (See Box 1.1)**

- Evaluation is directed at determining the nature, severity, control, and stability of disease.

Potential Issues and Factors of Concern**A**

Analgesics	NSAIDs, including aspirin, and acetaminophen, as well as codeine and meperidine, should be avoided or their use very limited in persons who have end-stage liver disease.
Antibiotics	Antibiotic prophylaxis is not recommended; however, patients who have severe liver disease may be more susceptible to infection. Selection of antibiotic agent is based on risk and severity of dental infection. Avoid use of metronidazole and vancomycin.
Anesthesia	Higher doses may be required to achieve adequate anesthesia in presence of alcoholic liver disease. Knowledge of current liver function is important to establish proper dosages. Epinephrine (1:100,000, in a dose of no more than 2 carpules) in local anesthetics generally is not associated with any problems, but patients should be monitored closely.
Anxiety	Use anxiety and stress reduction techniques as needed but avoid benzodiazepines.
Allergy	No issues

B

Breathing	No issues
Bleeding	Excessive bleeding may occur in patients with end-stage liver disease. Most such patients will have reductions in coagulation factors and thrombocytopenia, so they are at greater risk for postsurgical bleeding; they may need vitamin K or platelet or clotting factor replacement (or both).
Blood pressure	Monitor blood pressure because it may be significantly increased with portal hypertension in patients with end-stage liver disease.
Blood tests	HBsAg testing for HBV status as well as anti-HBs and anti-HCV testing as indicated by history and exposure

C

Chair position	No issues
Consultation	When the patient is under good medical management, the dental treatment plan is unaffected. However, consultation with the patient's physician to establish the level of chronic liver disease and control (CBC, ALT/AST) and to identify bleeding tendencies (PT, BT) and altered drug metabolism is recommended as part of the management program. Elective treatment should be delayed for patients with any form of active hepatitis.

D

Devices	No issues
Drugs	Because many medications are metabolized in the liver, certain drugs may need to be avoided or reduced in dosage. Limit or avoid use of acetaminophen, aspirin, ibuprofen, codeine, meperidine, diazepam, barbiturates, metronidazole, and vancomycin. Refer to a good drug reference. The use of epinephrine or other pressor amines (in gingival retraction cord or to control bleeding) must be limited, especially if portal hypertension is present.

E

Equipment	No issues
Emergencies and urgent care	For patients with severe liver disease who require urgent care, consider treating in a special care clinic or hospital. When emergency dental treatment is necessary in patients with active hepatitis, isolation may be necessary. After consulting with a physician, provide limited care only for pain control, treatment of acute infection, or control of bleeding until condition improves.

F

Follow-up	It is important to follow up with the patient postoperatively to be certain that there are no complications.
-----------	--

ALT, Alanine aminotransferase; AST, aspartate aminotransferase; BT, Bleeding time; CBC, complete blood count; HBsAg, hepatitis B surface antigen; HBV, hepatitis B virus; HCV, hepatitis C virus; NSAID, nonsteroidal antiinflammatory drug; PT, prothrombin time.

determining the need for HBIG, vaccination, and follow-up medical care.²⁹

Patients Who Are Hepatitis Carriers. If a patient is found to be a hepatitis B carrier (HBsAg positive) or has a history of hepatitis C, standard precautions (see Appendix B) must be followed to prevent transmission of infection. In addition, some hepatitis carriers may have chronic active hepatitis, leading to compromised liver

function and interference with hemostasis and drug metabolism. Physician consultation and laboratory screening of liver function are advised to determine current status and future risks.²⁹

Patients With Signs or Symptoms of Hepatitis. Any patient who has signs or symptoms suggestive of hepatitis should not receive elective dental treatment but instead should be referred immediately to a physician (see Box

BOX 10.3 Dental Drugs Metabolized Primarily by the Liver

Local Anesthetics*

Lidocaine (Xylocaine)
Mepivacaine (Carbocaine)
Prilocaine (Citanest)
Bupivacaine (Marcaine)

Analgesics

Aspirin[†]
Acetaminophen (Tylenol, Datril)[‡]
Codeine[‡]
Meperidine (Demerol)[‡]
Ibuprofen (Motrin)[†]

Sedatives

Diazepam (Valium)[‡]
Barbiturates[‡]

Antibiotics

Ampicillin
Tetracycline
Metronidazole[§]
Vancomycin[§]

*Most of these agents appear to be safe for use in patients with liver disease when given in appropriate amounts.

[†]Limit dose or avoid if severe liver disease (acute hepatitis and cirrhosis) or hemostatic abnormalities are present.

[‡]Limit dose or avoid if severe liver disease (acute hepatitis and cirrhosis) or encephalopathy is present, or if taken with alcohol.

[§]Avoid if severe liver disease (acute hepatitis and cirrhosis) is present.

10.2). Necessary emergency dental care can be provided by using an isolated operatory and minimizing aerosol production.^{1,3b}

Drug Administration

No special drug considerations are needed for a patient who has completely recovered from viral hepatitis. If the patient has chronic active hepatitis, however, or is a carrier of HBsAg or HCV and has impaired liver function, the dosage for drugs metabolized by the liver should be decreased or such drugs avoided if possible, as advised by the patient's physician (see Box 10.2). As a guideline, drugs metabolized in the liver should be considered for diminished dosage when one or more of the following factors are present (see Table 10.4): Child-Pugh classification as well as the Model of End-Stage Liver Disease (MELD) system: (1) elevation of aminotransferase levels to greater than four times normal; (2) elevation of serum bilirubin above 35 mM/L or 2 mg/dL; (3) serum albumin levels less than 35 g/L; and (4) signs of ascites, encephalopathy, and malnutrition. Many drugs commonly used in dentistry are metabolized principally by the liver, but in other than the most severe cases of hepatic disease, these drugs can be used, although in limited amounts (see Box 10.3). A one-procedure dose of three cartridges

of 2% lidocaine (120 mg) is considered to represent a relatively limited amount of drug.^{4,5}

Treatment Planning Modifications

Treatment planning modifications are not required for patients who have recovered from hepatitis.

Oral Manifestations and Complications. A problem that may be associated with chronic hepatitis and significant liver damage (or cirrhosis) is abnormal bleeding (see Chapter 24). The bleeding problem can be the result of abnormal synthesis of blood clotting factors, abnormal polymerization of fibrin, inadequate fibrin stabilization, excessive fibrinolysis, or thrombocytopenia associated with splenomegaly that accompanies chronic liver disease. Before any surgery is undertaken, a platelet count should be performed to determine whether platelet replacement may be required before surgery and should be discussed with the patient's physician (see Chapter 24).^{1-5,30}

Chronic viral hepatitis increases the risk for hepatocellular carcinoma. This malignancy rarely metastasizes to the jaw (<30 cases had been reported as of 2015).^{31,32} However, the incidence of hepatocellular carcinoma is on the rise in the United States. Oral metastases primarily manifest as hemorrhagic expanding masses located in the premolar and ramus region of the mandible.^{31,32}

POSTEXPOSURE PROTOCOLS FOR HEALTH CARE WORKERS

To reduce the risk of transmission of hepatitis viruses, the CDC has published postexposure protocols for percutaneous or permucosal exposures to blood. Implementation of the protocol is dependent on the virus present in the source person and the vaccination status of the exposed person (e.g., a dental health care worker) (see Table 10.4).²⁹

The CDC guidelines for exposures involving HBV outline protocols for both vaccinated and unvaccinated persons. For example, a vaccinated health care worker who sustains a needlestick or puncture wound contaminated with blood from a patient known to be HBsAg positive should be tested for an adequate titer of anti-HBs if those levels are unknown. If the levels are inadequate, the worker should immediately receive an injection of HBIG and a vaccine booster dose. (The risk of contracting HBV infection from a sharps injury in health care workers from HBV carriers may approach 30%.) If the antibody titer is adequate, however, nothing further is required. If an unvaccinated person sustains an inadvertent percutaneous or permucosal exposure to hepatitis B, immediate administration of HBIG and initiation of the vaccine are recommended.²⁹

Although no postexposure protocol or vaccine is available yet for HCV infection, current CDC guidelines include the following recommendations: (1) The source person should receive baseline testing for anti-HCV, (2) exposed persons should receive baseline and follow-up

testing at 6 months for anti-HCV and liver enzyme activity, (3) anti-HCV enzyme immunoassay positive results should be confirmed by recombinant immunoblot assay (RIBA), (4) postexposure prophylaxis with immunoglobulin or antiviral agents should be avoided, and (5) health care workers should be educated regarding the risk and prevention of bloodborne infections.²⁹

EXPOSURE CONTROL PLAN

With respect to hepatitis viruses, OSHA mandates that all employers maintain an exposure control plan and protect their employees from the hazards of bloodborne pathogens by using standard precautions and providing the following as a minimum: (1) hepatitis B vaccinations to employees, (2) postexposure evaluation and follow-up, (3) recordkeeping for exposure data, (4) generic bloodborne pathogens training, and (5) personal protective equipment made available at no cost. All dentists should be familiar with OSHA's compliance directive "Enforcement Procedures for the Occupational Exposure to Bloodborne Pathogens" (CPL 02-02-069; available at http://www.osha.gov/pls/oshaweb/owadisp.show_document?p_table=DIRECTIVES&p_id=257).³³

ALCOHOLIC LIVER DISEASE

Definition

Excessive alcohol consumption causes alcoholic liver disease and ultimately cirrhosis of the liver and worsens other liver disorders such as viral hepatitis.² Alcohol is hepatotoxic and its metabolite, acetyl aldehyde, is fibrinogenic. The quantity and the duration of alcohol ingestion required to produce cirrhosis are not clear. However, the typical alcoholic with cirrhosis has a history for at least 10 years of daily consumption of a pint or more of whiskey, several quarts of wine, or an equivalent amount of beer.^{2,8,34-39} A relationship exists between excessive alcohol ingestion and liver dysfunction, leading to end-stage liver disease or cirrhosis. Also implicated in the pathogenesis of alcoholic liver disease are *cytokines*. Alcohol-induced influx of endotoxin (lipopolysaccharides) from the gut into the portal circulation can activate Kupffer cells, leading to enhanced chemokine release. Chemokines, in turn, directly and indirectly damage liver hepatocytes. Curiously, only 10% to 15% of heavy alcohol users ever develop cirrhosis, a fact probably explained by hereditary, nutrition, and biochemical differences among individual patients.^{2,8,34-39}

The lack of treatment of alcohol abuse leads to significant morbidity and mortality rates. Chapter 30 discusses dental patients with alcohol abuse. Current figures indicate that more than 100,000 persons die annually in the United States as a consequence of alcohol abuse, and more than 20% of all hospital admissions are alcohol related. Cirrhosis is a sequela of alcohol abuse and the 10th leading cause of death among adults in the United States. In

addition, ethanol alone or with other drugs such as benzodiazepines probably is responsible for more toxic overdose deaths than those attributable to any other agent.^{2,8,34-39}

Pathophysiology and Complications

Alcohol has a deleterious effect on neural development, the corticotropin-releasing hormone system, metabolism of neurotransmitters, and the function of neurotransmitter receptors. As a result, the acetylcholine and dopaminergic systems are impaired, causing sensory and motor disturbances (e.g., peripheral neuropathies). Prolonged abuse of alcohol contributes to malnutrition (folic acid deficiency), anemias, and decreased immune function. Increased mortality rates have been noted for men who consume more than three drinks daily.^{2,8,34-39}

The pathologic effects of alcohol on the liver are expressed as one of three disease entities. These conditions may exist alone but commonly appear in combination. The earliest change seen in alcoholic liver disease is so-called *fatty liver*, characterized by presence of a fatty infiltrate. The hepatocytes become engorged with fatty lobules and distended, with enlargement of the entire liver. No other structural changes usually are noted. This condition may emerge after only moderate usage of alcohol for a brief time; however, it is considered completely reversible.^{2,8,34-39}

A second and more serious form of alcoholic liver disease is *alcoholic hepatitis*. This diffuse inflammatory condition of the liver is characterized by destructive cellular changes, some of which may be irreversible. The irreversible changes can lead to necrosis. Nutritional factors may play a significant role in the progression of this disease. For the most part, alcoholic hepatitis is considered a reversible condition; however, it can be fatal if damage is widespread.^{2,8,34-39}

The third and most serious form of alcoholic liver disease is *cirrhosis*, which generally is considered an irreversible condition characterized by progressive fibrosis and abnormal regeneration of liver architecture in response to chronic injury or insult (i.e., prolonged and heavy use of ethanol) (Fig. 10.5). Cirrhosis results in the progressive deterioration of the metabolic and excretory functions of the liver, ultimately leading to hepatic failure. Hepatic failure is manifested by a myriad of health problems. Some of the more important of these are esophagitis, gastritis, and pancreatitis, which contribute to generalized malnutrition, weight loss, protein deficiency (including coagulation factors), impairment of urea synthesis and glucose metabolism, endocrine disturbances, encephalopathy, renal failure, portal hypertension, and jaundice. Accompanying portal hypertension is the development of ascites and esophageal varices (Fig. 10.6). In some patients with cirrhosis, blood from bleeding ulcers and esophageal varices is incompletely metabolized to ammonia, which travels to the brain and contributes to encephalopathy. In addition, chronic large consumption of ethanol

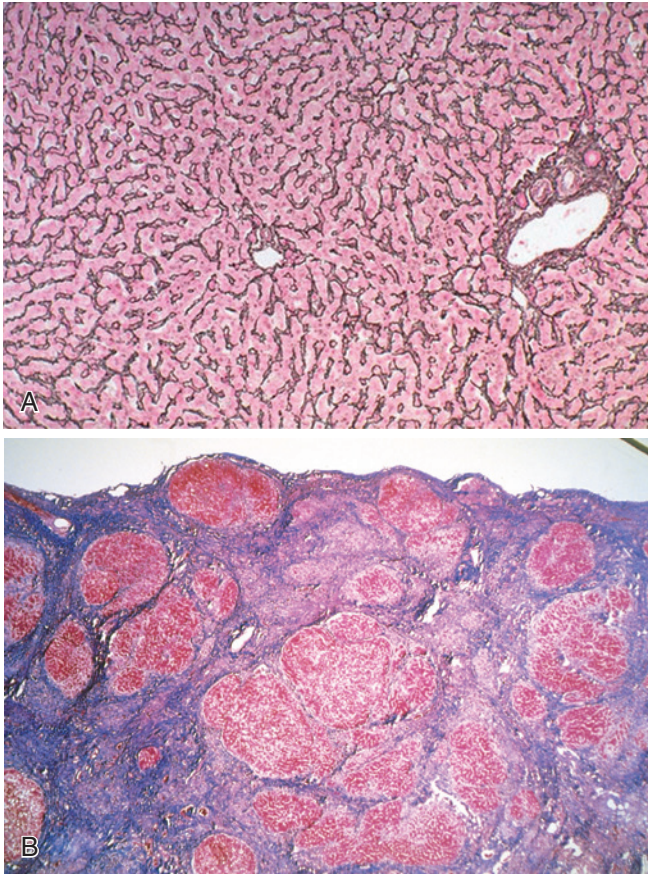
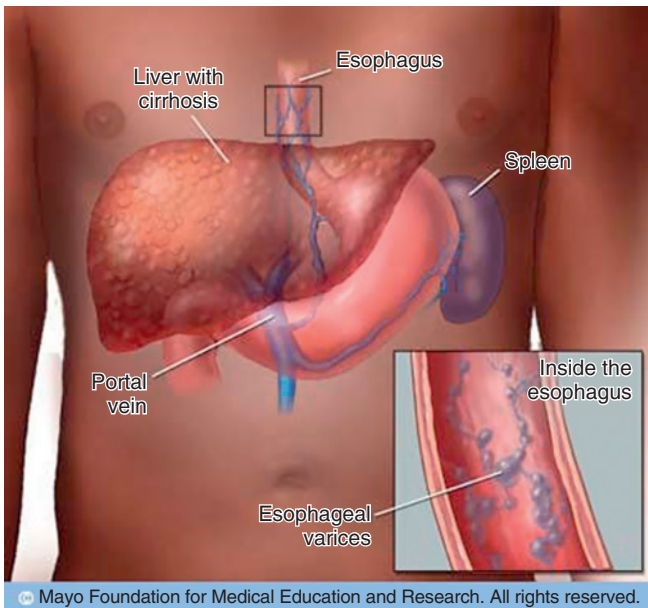

FIG 10.5 Photomicrographs showing liver architecture. **A**, Normal liver. **B**, Liver in alcoholic cirrhosis. (A, From Klatt EC: In *Robbins & Cotran atlas of pathology*, ed 2, Philadelphia, 2010, Saunders. B, From Kumar V, Abbas AK, Mitchell RN et al, editors: *Robbins basic pathology*, ed 8, Philadelphia, 2007, Saunders.)



© Mayo Foundation for Medical Education and Research. All rights reserved.

FIG 10.6 Esophageal varices from an alcoholic patient.

can result in dementia and psychosis (Wernicke and Korsakoff syndromes), cerebellar degeneration, upper alimentary tract cancer and liver cancer, and hematopoietic changes.^{2,8,34-39}

Classically, severe alcoholic steatohepatitis (formerly called “alcoholic hepatitis”) is characterized by the sudden development of tender hepatomegaly, jaundice, and fever in a person who has been drinking heavily. Often, the illness is associated with a flulike prodrome that includes malaise, anorexia, and weakness. These symptoms sometimes prompt reduced alcohol ingestion, which in turn may precipitate an alcohol withdrawal syndrome (see [Chapter 30](#)). Some affected persons require hospitalization because of decompensated liver disease or associated conditions such as alcohol withdrawal syndrome, GI bleeding, infection, or pancreatitis. Although most people gradually recover during early abstinence, others deteriorate despite abstinence and aggressive management of their associated problems.^{2,8,34-39}

Bleeding tendencies are a significant feature in advanced liver disease. The basis for the diathesis is in part a deficiency of coagulation factors, especially the prothrombin group (factors II, VII, IX, and X). These factors all rely on vitamin K as a precursor for production (see [Chapter 24](#)). Vitamin K is absorbed from the large intestine and stored in the liver, where it is converted into an enzymatic cofactor for the carboxylation of prothrombin complex proteins. Widespread hepatocellular destruction as seen in cirrhosis decreases the liver’s storage and capacity for conversion of vitamin K, leading to deficiencies of the prothrombin-dependent coagulation factors. In addition to these deficiencies, thrombocytopenia may be caused by hypersplenism secondary to portal hypertension and to bone marrow depression. Anemia and leukopenia also may result from toxic effects of alcohol on the bone marrow and nutritional deficiencies. Accelerated fibrinolysis also is seen.^{2,8,34-39}

The combination of hemorrhagic tendencies and severe portal hypertension (which causes thrombocytopenia as a consequence of sequestration of platelets in the spleen) sets the stage for episodes of GI bleeding, epistaxis, ecchymoses, or ruptured esophageal varices. Most patients with advanced cirrhosis die of complications of hepatic coma, often precipitated by massive hemorrhage from esophageal varices or intercurrent infection.^{2,8,34-39}

Ethanol abuse predisposes the person engaging in such behaviors to infection by several mechanisms. The liver’s resident cell population in patients with alcoholism is exposed to high concentrations of ethanol. The Kupffer cells, representing more than 80% of tissue macrophages in the body, become impaired with continued bathing of the liver sinusoids in alcohol. Alcohol-induced impairment of Kupffer cell function and T-cell responses results in increased risk of infection. Although cirrhosis generally is considered to be an end-stage condition, some evidence suggests that at least partial reversibility of the process is possible with complete and permanent removal

of the offending agent during the early phase of cirrhosis.^{2,8,34-39}

Clinical Presentation

The behavioral and physiologic effects of alcohol depend on the amount of intake, its rate of increase in plasma, concomitant use of other drugs or concurrent medical problems, and the past experience with alcohol. Chronic heavy alcohol intake can result in clinically significant cognitive impairment (even when the affected person is sober) or distress. The pattern displayed usually is one of intermittent relapse and remission. If the dependency problem is allowed to progress untreated, the development of other psychiatric problems (anxiety, antisocial behavior, and affective disorders) is common, with the emergence of alcohol amnestic disorder, in which the patient is unable to learn new material or to recall known material, in some cases. Alcoholic blackouts also may be a feature. In some patients, alcohol-induced dementia and severe personality changes develop.^{2,8}

Clinically, with the possible exception of enlargement, no visible manifestations of a fatty liver are present, and the diagnosis usually is made incidentally in conjunction with evaluation for another illness. The clinical presentation of alcoholic hepatitis often is nonspecific and may include features such as nausea, vomiting, anorexia, malaise, weight loss, and fever. More specific findings include hepatomegaly, splenomegaly, jaundice, ascites, ankle edema, and spider angiomas. With advancing disease, encephalopathy and hepatic coma may ensue, ending in death.^{2,35,36}

Alcoholic cirrhosis may remain asymptomatic for many years until sufficient destruction of the liver parenchyma has occurred to produce clinical evidence of hepatic failure. Ascites, spider angiomas (Fig. 10.7), ankle edema, and jaundice may be the earliest manifestations, but frequently hemorrhage from esophageal varices is the initial sign. The hemorrhagic episode may herald rapid progression

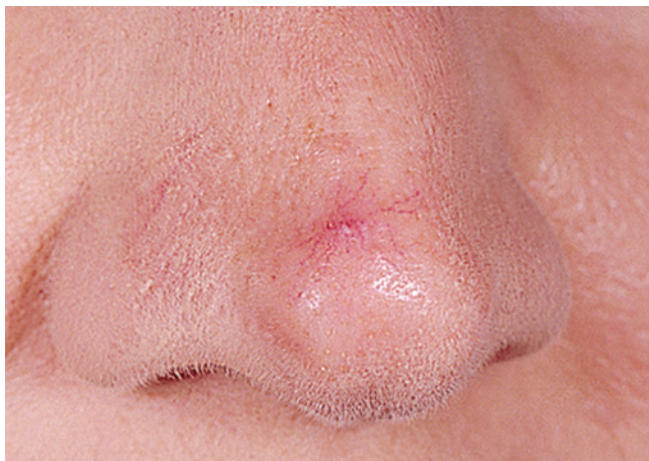

FIG 10.7 Spider angioma. (From Swartz MH: *Textbook of physical diagnosis*, ed 6, Philadelphia, 2010, Saunders.)

to hepatic encephalopathy, coma, and death. Other, less specific signs of alcoholic liver disease include anemia, purpura, ecchymoses, gingival bleeding, palmar erythema, nail changes, and parotid gland enlargement (known as sialadenosis)^{2,8,34-39} (Fig. 10.8).

Laboratory Findings

Laboratory findings in alcoholic liver disease range in significance from minimal abnormalities caused by a fatty liver to manifestations of alcoholic hepatitis and cirrhosis. Liver abnormalities cause elevations of bilirubin, alkaline phosphatase, AST, ALT, GGT, amylase, uric acid, triglyceride, and cholesterol levels. Leukopenia (or leukocytosis) or anemia often is present. A simple screen for alcoholism can be performed using a sequential Mult-Analyzer-20 and CBC with differential. Elevated blood levels of GGT and mean corpuscular volume are highly suggestive of alcoholism, and an AST-to-ALT ratio of at least 2 is 90% predictive of alcoholic liver disease. The carbohydrate-deficient transferrin test also is used to screen for and monitor clinical status in alcohol dependency.^{2,8,34-39}

Alcoholic liver disease also leads to deficiencies of clotting factors reflected as elevations in the prothrombin time and partial thromboplastin time. Thrombocytopenia may be present owing to hepatosplenomegaly, causing a decreased platelet count. Increased fibrinolytic activity may be evidenced by a prolonged thrombin time or a decreased euglobulin clot lysis time (see Chapter 24).^{2,8,34-39}

Medical Management

The absolute best management for alcoholic liver disease is total abstinence. In fact, significant improvement in alcoholic fatty degeneration of hepatic cells can be seen in only 18 months after abstinence.² However, of course, often that is very difficult to achieve.^{2,34,35,40} Treatment of patients with alcoholism consists of three basic steps.



FIG 10.8 Painless enlargement of the parotid glands associated with alcoholism.

The first and second steps consist of identification and intervention, respectively. A thorough physical examination is performed to evaluate organ systems that could be impaired. This assessment includes a search for evidence of liver failure, GI bleeding, cardiac arrhythmia, and glucose or electrolyte imbalance. Hemorrhage from esophageal varices and hepatic encephalopathy require immediate treatment. Ascites mandates measures to control fluids and electrolytes, alcoholic hepatitis often is treated with glucocorticoids, and infection or sepsis is managed with antimicrobial agents. During this phase, the patient may refuse to accept the diagnosis and often will deny that a problem exists (see [Chapter 30](#)).^{2,8,34-39}

The third step is to manage the central nervous system (CNS) depression caused by the rapid removal of ethanol. Administration of a benzodiazepine, such as diazepam or chlordiazepoxide, with gradual decrease in serum levels of the drug occurring over a 3- to 5-day period, alleviates alcohol withdrawal symptoms. The beta-blockers clonidine and carbamazepine are more recent additions to the pharmacotherapeutic management of withdrawal.^{2,8,34-39}

After treatment of withdrawal has been completed, the patient is educated about the disease of alcoholism. The education program should include teaching family members and friends to stop protecting the patient from the problems caused by alcohol. Attempts are made to help the patient with alcoholism achieve and maintain a high level of motivation toward abstinence. Other interventions are aimed at helping the patient with alcoholism to readjust to life without alcohol and to reestablish a functional lifestyle. The drug disulfiram has been used for some patients during alcohol rehabilitation. Disulfiram inhibits aldehyde dehydrogenase, causing accumulation of acetaldehyde blood levels and thus sweating, nausea, vomiting, and diarrhea when taken with ethanol. Naltrexone (an opioid antagonist) and acamprosate (an inhibitor of the γ -aminobutyric acid [GABA] system) may be used to decrease the amount of alcohol consumed or shorten the period during which alcohol is used in cases of relapse. Untreated disease that progresses to cirrhosis requires alcohol withdrawal and management of any complications that arise. End-stage cirrhosis cannot be reversed and is remedied only by liver transplantation (see [Chapter 21](#)).^{2,41}

Recently, some new concepts for the treatment of chronic cirrhosis have emerged. Because the main pathology associated with cirrhosis is decreased blood supply, fibrosis, and scarring of the liver parenchyma, investigators are successfully using angiogenic agents to essentially grow new blood vessels to supply liver tissue and decrease the damage from cirrhosis.⁴²

Dental Management

In addition to the aforementioned considerations, and upon identification of the dental patient with significant liver disease, there are some major areas of concern in providing dental treatment (see [Box 10.2](#)).

A CBC with differential and determinations of AST and ALT, bleeding time, thrombin time, and prothrombin time are needed to identify the patient for potential problems. Abnormal laboratory values, on a background of suggestive findings on the clinical examination or a positive history, constitute the basis for referral to a physician for definitive diagnosis and treatment. A patient with untreated alcoholic liver disease is not a candidate for elective, outpatient dental care and should be referred to a physician. After good medical management has been instituted and the patient appears stable, dental care may be provided after consultation with the physician.^{2,4,5,8,36,39}

If a patient provides a history of alcoholic liver disease or alcohol abuse, the physician should be consulted to verify the patient's current status; medications; laboratory values; and contraindications to medications, surgery, or other treatment. When a patient has not been seen by a physician within the past several months, screening laboratory tests should be ordered, including a CBC with differential and determinations of AST and ALT, platelet count, thrombin time, and prothrombin time before invasive procedures are undertaken.^{2,4,5,8,36,39}

Antibiotics. Patients with chronic liver disease may be somewhat susceptible to infection, but there is rarely a need for antibiotic prophylaxis. However, there is a risk for infection or spread of infection in the patient who has alcoholic liver disease. Risk increases with surgical procedures or trauma, which can introduce oral microorganisms into the blood circulation, with less efficient elimination by the reticuloendothelial system owing to impaired cellular function. Antibiotic prophylaxis is not needed if oral infection is absent. Of greater concern is the risk for spread of a preexisting infection, because bacterial infections are more serious and sometimes fatal in patients with liver disease.^{2,4,5,8,36,39} To identify patients likely to respond poorly to invasive procedures and infections, the clinician should consider using one of the assessment formulas for staging liver disease (i.e., Child-Pugh or MELD classification scheme) ([Table 10.5](#)) as well as identifying whether a history of bacterial infections (e.g., spontaneous bacterial peritonitis, pneumonia, bacteremia) exists. Consultation with the patient's physician regarding the use of antibiotics should be considered for persons with moderate to severe disease (Child-Pugh class B or C—characterized by ascites, encephalopathy, elevated bilirubin levels, or increase in systolic blood pressure). Antibiotics should be provided when infection is present and unlikely to resolve without such treatment.^{2,4,5,8,36,39,42}

Some antibiotics may be contraindicated, or their dose may require adjustment. There may be some issues with analgesics as well (see [Box 10.3](#)).

Bleeding. Precautionary measures to minimize the risk for bleeding (see [Chapter 24](#)), including a prothrombin time test that is particularly sensitive to deficiency of factor VII, also are indicated.^{2,4,5,8} Bleeding diatheses should

TABLE 10.5 The Two Most Commonly Used Scoring Systems in Grading Cirrhosis

1. CHILD-PUGH-TURCOTTE (CPT) SCORE (RANGE, 5-15)			
Parameter	Points Ascribed		
	1	2	3
Ascites	None	Grade 1–2 (or easy to treat)	Grade 3–4 (or refractory)
Hepatic encephalopathy	None	Grade 1–2 (or induced by a precipitant)	Grade 3–4 (or spontaneous)
Bilirubin (mg/dL)	<2	2–3	>3
Albumin (g/dL)	>3.5	2.8–3.5	<2.8
Prothrombin time (seconds > control) <i>or</i>	<4	4–6	>6
INR	<1.7	1.7–2.3	>2.3

CPT Classification			
Child A: score of 5–6			
Child B: score of 7–9			
Child C: score of 10–15			

2. MODEL OF END-STAGE LIVER DISEASE (MELD) SCORE (RANGE, 6–40)			
Score = $[0.957 \times \ln \text{creatinine (mg/dL)} + 0.378 \times \ln \text{bilirubin (mg/dL)} + 1.12 \times \ln \text{INR} + 0.643] \times 10$			

INR, International normalized ratio; *ln*, natural logarithm.

be managed in conjunction with the physician and may entail use of local hemostatic agents, fresh-frozen plasma, vitamin K, platelets, and antifibrinolytic agents. Hemostatic measures are particularly important when major invasive or traumatic procedures are performed in a patient who has been assigned an American Society of Anesthesiologists category of III or higher and exhibits signs of jaundice, ascites, or clubbing of the fingers or with alcoholic liver disease of Child-Pugh class B or C or MELD grade of moderate-severe (see Table 10.4).^{2,40}

Capacity to Tolerate Care

Drug Considerations. An area of concern in patients with liver disease is the unpredictable metabolism of drugs.^{2,4,5,8,36,39} This concern is twofold: In mild to moderate alcoholic liver disease, significant enzyme induction is likely to have occurred, leading to an increased tolerance of local anesthetics, sedative and hypnotic drugs, and general anesthesia. Thus, larger-than-normal doses of these medications may be required to obtain the desired effects.^{2,4,5,8,36,39}

Also, with more advanced liver destruction, drug metabolism may be markedly diminished, potentially leading to an increased or unexpected effect. For example, if acetaminophen is used in usual therapeutic doses in chronic alcoholism or if acetaminophen is taken with alcohol during a fasting state, severe, fatal hepatocellular disease may result. The dentist should exercise caution in use of the drugs listed in Box 10.3 when treating patients with chronic alcoholism. The dose may need to be adjusted (e.g., half the regular adult dose may be appropriate if cirrhosis or alcoholic hepatitis is present), or a specific agent or class of drugs may be contraindicated as advised by the patient's physician. Again, the presence of more than one of the following findings is suggestive that drug metabolism will be impaired: aminotransferase levels

elevated to higher than four times normal; serum bilirubin level elevated above 35 mM/L (2 mg/dL); serum albumin level less than 35 g/L; and signs of ascites, encephalopathy, or malnutrition (see Table 10.4).^{2,4,5,8,36,39}

Treatment Planning Modifications. Patients with cirrhosis tend to have more plaque, calculus, and gingival inflammation than patients without the condition. This seems to be the case in any patient who is a substance abuser and is related to oral neglect rather than to any inherent property of the abused substance. As indicated by the degree of neglect and extent of caries and periodontal disease, the dentist should not provide extensive care until the patient demonstrates an interest in and ability to care for the dentition.^{4,5,43}

Liver enzyme induction and CNS effects of alcohol in patients with alcoholism can require use of increased amounts of local anesthetic or additional anxiolytic procedures. Appointments with these patients may therefore require more than the scheduled time if this manifestation was not anticipated.

Oral Complications and Manifestations. Poor hygiene and neglect (as evidenced by caries) are prominent oral manifestations of chronic alcoholism. In addition, a variety of other abnormalities may be found (Box 10.4). Patients with cirrhosis have been reported to have impaired gustatory function and are malnourished. Nutritional deficiencies can result in glossitis and loss of tongue papillae, along with angular or labial cheilitis, which may be complicated by concomitant candidal infection. Vitamin K deficiency, disordered hemostasis, portal hypertension, and splenomegaly (causing thrombocytopenia) can result in spontaneous gingival bleeding and mucosal ecchymoses and petechiae. In some instances, unexplained gingival bleeding has been the initial complaint of patients with alcoholism. Also, a sweet, musty odor to the breath is

BOX 10.4 Features Suggestive of Advanced Alcoholic Liver Disease

Systemic complications

Traumatic or unexplained injuries (driving under the influence, bruises, cuts, scars, broken teeth)

Attention and memory deficits

Encephalopathy

Slurred speech

Spider angiomas

Jaundice (sclerae, mucosa)

Peripheral edema (edematous puffy face, ankle edema)

Ascites

Palmar erythema, white nails or transverse pale band on nails

Ecchymoses, petechiae, or prolonged bleeding

Failure to fulfill role obligations at work, school, home (e.g., missed dental appointments)

Increased levels of bilirubin >35 mg/mL, aminotransferases (>4× normal), alkaline phosphatase, and γ -glutamyl transpeptidase; increased mean corpuscular volume and decreased serum albumin (<35 mg/mL)

Oral Complications

Poor oral hygiene

Oral neglect: caries, gingivitis, periodontitis

Glossitis

Angular or labial cheilosis

Candidiasis

Gingival bleeding

Oral cancer

Petechiae

Ecchymoses

Jaundiced mucosa

Parotid gland enlargement

Alcohol (sweet musty) breath odor

Impaired healing

Bruxism

Dental attrition

Xerostomia

associated with liver failure, as is jaundiced mucosal tissue.^{2,8,43,44}

A bilateral, painless hypertrophy of the parotid glands, termed *sialadenosis*, is a frequent finding in patients with cirrhosis. The enlarged glands are soft and nontender and are not fixed to the overlying skin. The condition appears to be caused by a demyelinating polyneuropathy that results in abnormal sympathetic signaling, abnormal acinar protein secretion, and acinar cytoplasmic swelling. In *sialadenosis*, the parotid ducts remain patent and produce clear salivary flow.^{8,44,45}

Alcohol abuse and tobacco use are strong risk factors for the development of oral squamous cell carcinoma, and as with all patients, the dentist must be aggressive in the detection of unexplained or suspicious soft tissue lesions (especially leukoplakia, erythroplakia, or ulceration) in patients with chronic alcoholism. Sites with a marked predilection for development of oral squamous cell

carcinoma include the lateral border of the tongue and the floor of the mouth (see Chapter 26).

REFERENCES

1. Wedemeyer H, Pawlotsky JM. Viral hepatitis. In: Goldman L, Schafer AI, eds. *Cecil Textbook of Medicine*. 25th ed. Elsevier; 2016:966-973, [Chapter 150]. ISBN 978-1-4377-1604-7.
2. Chalasani NP, Goldman L, Schafer AI, eds. *Alcoholic and Non-Alcoholic Steatohepatitis, Cecil Textbook of Medicine*. 25th ed. Elsevier; 2016:966-973, [Chapter 155]. ISBN 978-1-4377-1604-7.
- 3a. Ghany M, Hoofnagle JH. Approach to the patient with liver disease. In: Kasper D, Fauci A, Hauser S, et al, eds. *Harrison's Principles of Internal Medicine*. 19th ed. New York: McGraw-Hill; 2015.
- 3b. Firriolo FJ. Dental management of patients with end-stage liver disease. *Dent Clin North Am*. 2006;50:563-590, vii.
4. Golla K, Epstein JB, Cabay RJ. Liver disease: current perspectives on medical and dental management. *Oral Surg Oral Med Oral Pathol Oral Radiol Endod*. 2004;98:516-521.
5. Friedlander AH. Alcohol use and dependence. *J Am Dent Assoc*. 2003;134:731-740.
6. Centers for Disease Control and Prevention. Surveillance for acute viral hepatitis—United States, 2013. <http://www.cdc.gov/hepatitis/statistics/2013surveillance/index.htm>.
7. Nelson PK, Mathers BM, Cowie B, et al. Global epidemiology of hepatitis B and hepatitis C in people who inject drugs: results of systematic reviews. *Lancet*. 2011;378(9791):571-583.
8. Friedman LS. Surgery in the patient with liver disease. *Trans Am Clin Climatol Assoc*. 2010;121:192-204.
9. Durham DP, Scrip LA, Brucec RD, et al. The impact of enhanced screening and treatment on hepatitis C in the U.S. *Clin Infect Dis*. 2016;62(3):298-304.
10. Miyake Y, Iwasaki Y, Kobashi H, et al. Clinical features of autoimmune hepatitis diagnosed based on simplified criteria of the International Autoimmune Hepatitis Group. *Dig Liver Dis*. 2010;42:210-215.
11. Fassio E. Hepatitis C and hepatocellular carcinoma. *Ann Hepatol*. 2010;9(suppl):119-122.
12. Centers for Disease Control and Prevention. Hepatitis B information for health professionals (website): <http://www.cdc.gov/hepatitis/HBV/index.htm>. 2015.
13. Weismuller TJ, Fikatas P, Schmidt J, et al. Multicentric evaluation of model for end-stage liver disease-based allocation and survival after liver transplantation in Germany—limitations of the “sickest first” concept. *Transpl Int*. 2011;24:91-99.
14. Watanabe T, Soga K, Hirono H, et al. Features of hepatocellular carcinoma in cases with autoimmune hepatitis and primary biliary cirrhosis. *World J Gastroenterol*. 2009;15:231-239.
15. American Academy of Pediatrics Committee on Infectious Diseases. Hepatitis A vaccine recommendations. *Pediatrics*. 2008;120:189-199.
16. Advisory Committee on Immunization Practices (ACIP) Centers for Disease Control and Prevention (CDC).

- Update: prevention of hepatitis A after exposure to hepatitis A virus and in international travelers. Updated recommendations of the Advisory Committee on Immunization Practices (ACIP). *MMWR Morb Mortal Wkly Rep.* 2007;56:1080-1084.
17. Fujiwara A, Sakaguchi K, Fujioka S, et al. Fibrosis progression rates between chronic hepatitis B and C patients with elevated alanine aminotransferase levels. *J Gastroenterol.* 2008;43:484-491.
 18. Obika M, Shinji T, Fujioka S, et al. Hepatitis B virus DNA in liver tissue and risk for hepatocarcinogenesis in patients with hepatitis C virus-related chronic liver disease. A prospective study. *Intervirology.* 2008;51:59-68.
 19. Current treatment options for viral hepatitis. Medscape. <http://emedicine.medscape.com/article/177792-treatment>. Aug 3, 2015.
 20. Hung CH, Hu TH, Lu SN, et al. Tenofovir versus entecavir in treatment of chronic hepatitis B virus with severe acute exacerbation. *Antimicrob Agents Chemother.* 2015;59(6):3168-3173.
 21. Simmons B. Long-term treatment outcomes of patient infected with hepC virus. *Clin Infect.* 2015;61(5):730-740.
 22. Fabrizi F, Verdesca S, Messa P, et al. Hepatitis C virus infection increases the risk of developing chronic kidney disease. *Dig Dis Sci.* 2015;60(12):3801-3809.
 23. Poordad F, McCone J Jr, Bacon BR, et al, SPRINT-2 Investigators. Boceprevir for untreated chronic HCV genotype 1 infection. *N Engl J Med.* 2011;364:1195-1204.
 24. Zeuzem P. Peginterferon alfa-2a in patients with chronic hepatitis C. *N Engl J Med.* 2000;343:1666-1669.
 25. Foster GR, Afdahl SK, Roberts SK, et al. Sofosbuvir and velpatasvir for HCV genotype 2 and 3 infection. *New Engl J Med.* 2015;373(27):2608-2613.
 26. Afdhal N, Reddy R, Nelson D, et al. Ledipasvir and sofosbuvir for previously treated hep C type 1 infection. *New Engl J Med.* 2014;370(16):1220-1229.
 27. Roth D. Grazoprevir plus elbasvir in treatment-naive and treatment-experienced patients with hepatitis C virus genotype 1 infection and stage 4-5 chronic kidney disease (the C-SURFER study): a combination phase 3 study. *Lancet.* 2015;386(10003):1537-1545.
 28. Dhawan VK, Anand BS. Hepatitis C Treatment & Management with Viekira pak (ombitasvir, paritaprevir, ritonavir). <http://www.hepatitisfoundation.org/HEPATITIS/Hepatitis-overview.html?gclid=CJL03aKI1MkCFYMDaQod7NkLfw>.
 29. CDC Guidelines for Infection Control in Dental Health-Care Settings — 2003. <http://www.cdc.gov/oralhealth/infectioncontrol/#socialMediaShareContainer>.
 30. Brennan MT, Hong C, Furney SL, et al. Utility of an international normalized ratio testing device in a hospital-based dental practice. *J Am Dent Assoc.* 2008;139:697-703.
 31. Severi T, van Malenstein H, Verslype C, et al. Tumor initiation and progression in hepatocellular carcinoma: risk factors, classification, and therapeutic targets. *Acta Pharmacol Sin.* 2010;31:1409-1420.
 32. Sanyal AJ, Yoon SK, Lencioni R. The etiology of hepatocellular carcinoma and consequences for treatment. *Oncologist.* 2010;15(suppl 4):14-22.
 33. OSHA's compliance directive "Enforcement Procedures for the Occupational Exposure to Bloodborne Pathogens" (CPL 02-02-069); Available at http://www.osha.gov/pls/oshaweb/owadisp.show_document?p_table=DIRECTIVES&p_id=257.
 34. Rehm J, Kanteres F, Lachenmeier DW. Unrecorded consumption, quality of alcohol and health consequences. *Drug Alcohol Rev.* 2010;29:426-436.
 35. Katoonizadeh A, Laleman W, Verslype C, et al. Early features of acute-on-chronic alcoholic liver failure: a prospective cohort study. *Gut.* 2010;59:1561-1569.
 36. Stokkeland K, Ebrahim F, Ekbom A. Increased risk of esophageal varices, liver cancer, and death in patients with alcoholic liver disease. *Alcohol Clin Exp Res.* 2010;34:1993-1999.
 37. Yerian L. Histopathological evaluation of fatty and alcoholic liver diseases. *J Dig Dis.* 2011;12:17-24.
 38. Cohen JL, Nagy LE. Pathogenesis of alcoholic liver disease: interactions between parenchymal and non-parenchymal cells. *J Dig Dis.* 2011;12:3-9.
 39. Beier JL, Arteel GE, McClain CJ. Advances in alcoholic liver disease. *Curr Gastroenterol Rep.* 2011;13:56-64.
 40. Gex L, Bernard C, Spahr L. Child-Pugh, MELD and Maddrey scores. *Rev Med Suisse.* 2010;6:1803-1804, 1806-1808.
 41. Varma V, Webb K, Mirza DF. Liver transplantation for alcoholic liver disease. *World J Gastroenterol.* 2010;16:4377-4393.
 42. Calderone V, Gallego J, Fernandez-Miranda G, et al. Sequential functions of CPEB1 and CPEB4 regulate pathologic expression of VEGF and angiogenesis in chronic liver disease. *Gastroenterology.* 2015;doi:10.1053/j.gastro.2015.11.038.
 43. Lindroth J. Management of acute dental pain in the recovering alcoholic. *Oral Surg Oral Med Oral Pathol Oral Radiol Endod.* 2003;95:492-497.
 44. McCullough AJ, O'Shea RS, Dasarthy S. Diagnosis and management of alcoholic liver disease. *J Dig Dis.* 2011;12:257-262.
 45. Ojha J, Bhattacharyya I, Islam N, et al. Xerostomia and lichenoid reaction in a hepatitis C patient treated with interferon-alpha: a case report. *Quintessence Int.* 2008;39:343-348.

Gastrointestinal Disease

Gastrointestinal (GI) diseases such as peptic ulcer disease (PUD), inflammatory bowel disease (IBD), and pseudomembranous colitis are common and may affect the delivery of dental care. These patients can have several issues of clinical importance that require consideration by dental practitioners. The dentist must be cognizant of the patient's condition, must monitor for symptoms indicative of initial disease or relapse, and must be aware of drugs that interact with GI medications or that may aggravate these conditions. In addition, oral manifestations of GI disease are common, so the dentist must be familiar with oral patterns of systemic disease.

Awareness: Some patients who have GI disease are at risk for worsening of their condition as a result of dental treatment. Evaluation is critical to assess those at risk.

PEPTIC ULCER DISEASE

A peptic ulcer is a well-defined break in the GI mucosa (at least 0.5 mm in diameter) that results from chronic acid or pepsin secretions and the destructive effects of and host response to *Helicobacter pylori*.¹ Peptic ulcers develop principally in regions of the GI tract that are proximal to acid and pepsin secretions (Fig. 11.1). The first portion of the duodenum is the location of most ulcers in Western populations, whereas gastric ulcers are more frequent in Asia.¹ The upper jejunum rarely is involved.² PUD usually is chronic and focal in distribution; only about 10% of patients have multiple ulcers.

EPIDEMIOLOGY

Peptic ulcer disease is one of the most common human ailments, once affecting up to 15% of the population in industrialized countries. Current estimates suggest that 5% to 10% of the world population is affected, and about 350,000 new cases are diagnosed annually in the United States.^{3,4} The incidence of peptic ulceration peaked between 1900 and 1950 and progressively decreased thereafter.^{1,5} The decline in northern Europe and the United States may be the result of decreased cigarette and aspirin consumption, increased use of vegetable cooking oils (a rich source of raw materials for synthesis of prostaglandins, which have cytoprotective properties), and better sanitation leading to fewer *H. pylori* infections.⁶ The disease affects 5% to 7% of northern Europeans and accounts

for about 200,000 hospitalizations annually in the United States. Peptic ulcers are rare in Greenlander Eskimos, southwestern Native Americans, Australian aborigines, and Indonesians.⁷

About two thirds of persons with ulcers are men, and the peak prevalence of peptic ulceration occurs in older adults.¹ First-degree relatives have a threefold greater risk of developing the disease.⁸ Persons who smoke and are heavy drinkers of alcohol are more prone to development of the disease. An association with blood type O also is recognized. A higher prevalence is seen among patients with hyperparathyroidism and hypersecretory states (e.g., renal dialysis, Zollinger-Ellison syndrome, mastocytosis). Ingestion of nonsteroidal antiinflammatory drugs (NSAIDs), including aspirin, for longer than 1 month is associated with an annual rate of 2% to 4% for GI bleeding or ulcer complications in these patients.^{9,10}

The disease is rare in children, with only 1 in 2500 pediatric hospital admissions attributable to peptic ulceration.¹¹ When a peptic ulcer is diagnosed in a child younger than 10 years of age, the condition most often is associated with an underlying systemic illness, such as severe burn injury or other major trauma. Most deaths that result from PUD occur in patients older than 65 years of age. An average dental practice of 2000 adult patients is predicted to serve about 100 patients with PUD.

ETIOLOGY

Peptic ulcers result when the balance between aggressive factors that are potentially destructive to the GI mucosa and defensive factors that usually are protective of the mucosa is disrupted (Fig. 11.2). The primary aggressive factor is *H. pylori* (formerly *Campylobacter pylori*). This organism is associated with more than 80% of duodenal and gastric ulcers in the United States and more than 90% in other parts of the world.¹ Use of NSAIDs is the second most common cause of PUD. Other risk factors include advanced age, psychological and physical stress, acid hypersecretion, cigarette smoking, use of certain drugs (Table 11.1), and major comorbid disease.^{1,12} In addition, cystic fibrosis predisposes to ulcers because it reduces bicarbonate secretion, and cytomegalovirus infection is a rare cause of PUD in human immunodeficiency virus (HIV)-infected persons.^{1,13}

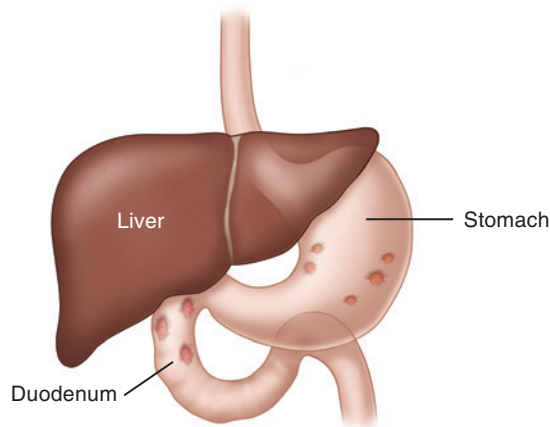

A



B

FIG 11.1 A, Location of peptic ulceration (*shaded areas*). *Darker-stippled areas* are higher risk sites. **B**, Peptic ulcer of the duodenum (B, From Kumar V, Abbas A, Fausto N, editors: *Robbins & Cotran pathologic basis of disease*, ed 7, Philadelphia, 2005, Saunders. Courtesy of Robin Foss, University of Florida–Gainesville.)

H. pylori is a microaerophilic, gram-negative, spiral-shaped motile bacillus with four to six flagella.¹⁴ *H. pylori* was first reported to reside in the antral mucosa by Marshall and Warren.¹⁵ The organism is an adherent but noninvasive bacterium that resides at the interface between the surface of the gastric epithelium and the overlying mucous gel. It produces a potent urease that hydrolyzes urea to ammonia and carbon dioxide. This urease may protect bacteria from the immediate acidic environment by increasing local pH while damaging mucosa through generation of its byproduct, ammonia. Upregulation of cyclooxygenase-2 (COX-2), chemotaxis of neutrophils, and the cellular immune response are involved in the local tissue damage that subsequently occurs.

Humans are the only known hosts of *H. pylori*. This bacterium infects 0.5% of adults annually, a rate that has been declining since the early 1990s.¹⁶ *H. pylori* is acquired primarily during childhood, possibly as a result of entry from the oral cavity via contaminated food and poor sanitary habits. The organism resides in the oral cavity,¹⁷ from which it probably descends to colonize the

TABLE 11.1 Drugs That Increase the Risk of Peptic Ulcer Disease

Drug	Frequency
NSAIDs, aspirin	Very common
Anticoagulants	Less common
Amphetamines, crack cocaine	Less common
Corticosteroids, mycophenolate	Less common
Oral bisphosphonates	Less common
Serotonin reuptake inhibitors	Less common

NSAID, Nonsteroidal antiinflammatory drug.

gastric mucosa. *H. pylori* can persist in the stomach indefinitely, and infection with the bacterium remains clinically silent in most affected persons. The rate of *H. pylori* acquisition is higher in developing than in developed countries. In developing countries, 80% of the population carries the bacterium by the age of 20 years, but in the United States, only 20% of 20-year-old individuals are infected. The prevalence of infection in the United States among African Americans and Hispanics is twice that for whites.¹⁸ Infection is correlated with lower socioeconomic status, contaminated drinking water, and familial overcrowding, especially during childhood. Approximately 20% of infected persons go on to develop PUD,¹² suggesting that other physiologic and psychological (stress) factors are required for presentation of this disease.¹⁹

Use of NSAIDs is an etiologic factor in about 15% of cases of peptic ulcer.¹ These drugs directly damage mucosa, reduce mucosal prostaglandin production, and inhibit mucus secretion. Ulcers caused by NSAIDs are located more often in the stomach than in the duodenum. Risk with NSAID use increases with age older than 60 years; high-dosage long-term therapy; use of NSAIDs with long plasma half-lives (e.g., piroxicam) rather than those with short half-lives (i.e., ibuprofen); and concomitant use of alcohol, corticosteroids, anticoagulants, or aspirin.²⁰ Use of orally administered nitrogen-containing bisphosphonate drugs (alendronate, risedronate) for the treatment of osteoporosis and immunosuppressive medications such as mycophenolate is associated with development of esophageal and gastric ulcers.²¹

H. pylori-negative, non-NSAID ulcer disease accounts for about 10% of cases and occurs more often in older adults.

PATHOPHYSIOLOGY AND COMPLICATIONS

Ulcer formation is the result of a complex interplay of aggressive and defensive factors (see Fig. 11.2). Resistance to acidic breakdown normally is provided by the mucosa, mucus and prostaglandin production, blood flow, bicarbonate secretion, and ion carrier exchange. Additional resistance is gained from the actions of antibacterial proteins such as lysozyme, lactoferrin, interferon, and α -defensin, or cryptdin.

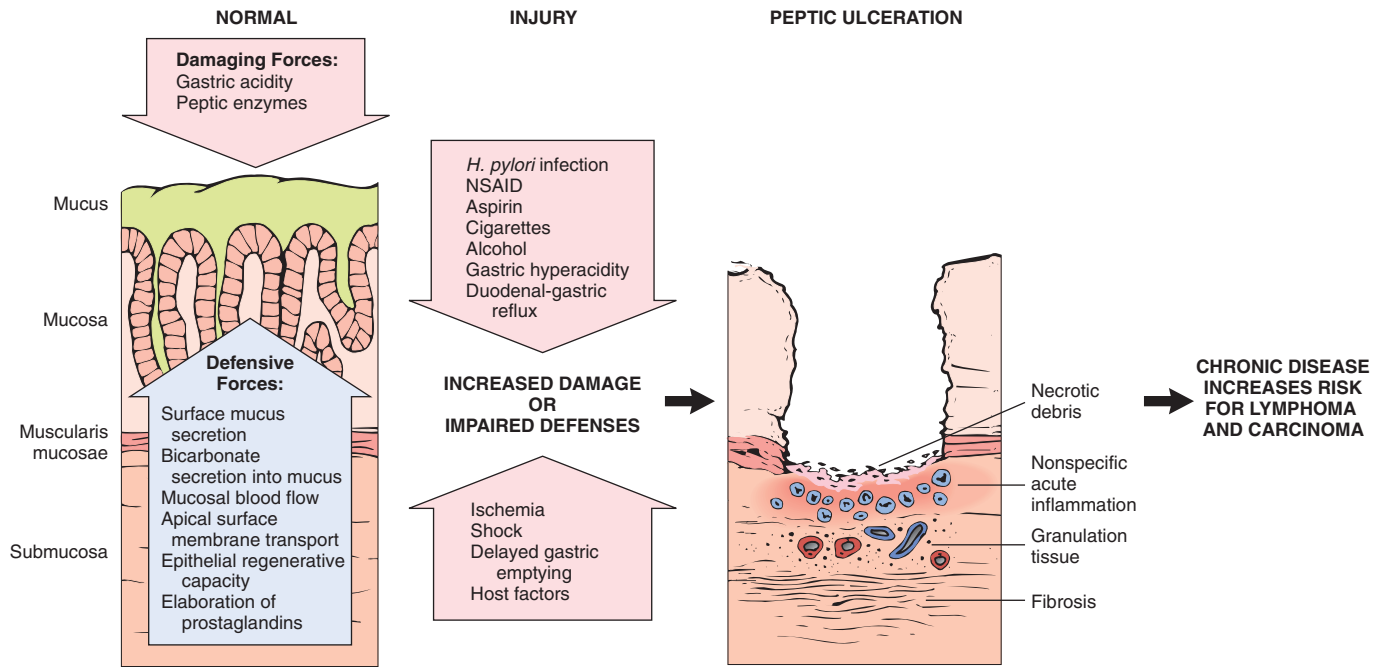

FIG 11.2 Complex interplay of aggressive and defensive factors involved in the formation of peptic ulcer disease. *NSAID*, Nonsteroidal antiinflammatory drug. (Modified from Kumar V, Abbas A, Fausto N, editors: *Robbins & Cotran pathologic basis of disease*, ed 7, Philadelphia, 2005, Saunders.)

Under normal circumstances, food stimulates gastrin release, gastrin stimulates histamine release by enterochromaffin-like cells in the stomach, and parietal cells secrete hydrogen ions and chloride ions (hydrochloric acid). Vagal nerve stimulation, caffeine, and histamine also are stimulants of parietal cell secretion of hydrochloric acid. Aggressive factors include vagal overactivity and agents and events that enhance the release of pepsin, gastrin, and histamine.¹ Physical and emotional stress; obsessive-compulsive behavior; parasitic infections; and drugs such as caffeine, high-dose corticosteroids, and phenylbutazone enhance hypersecretion of stomach acid. Alcohol and NSAIDs are directly injurious to gastric mucosa. Alcohol alters cell permeability and can cause cell death. NSAIDs including aspirin disrupt mucosal resistance by impairing prostaglandin production and denaturing mucous glycoproteins. Hyperparathyroidism enhances gastrin secretion, and renal dialysis does not adequately remove circulating gastrin. Smoking tobacco and family history are risk factors independent of gastric acid secretion for PUD.^{22,23} Tobacco smoke, similar to other aggressive factors, can affect gastric mucosa by reducing levels of nitric oxide, which is important for stimulating mucus secretion and maintaining mucosal blood flow.²⁴

H. pylori is strongly associated with PUD²⁵; however, the mechanism whereby infection with *H. pylori* results in PUD is not completely understood. Current evidence suggests that *H. pylori* causes inflammation of the gastric mucosa by producing proteases and increasing gastrin release by

G cells, which leads to increased gastric acid production, acute gastritis, and eventually ulcer formation.²⁶

Complications associated with PUD vary with the degree of destruction of the GI epithelium and supporting tissues. Superficial ulcers are characterized by the presence of necrotic debris, fibrin and subjacent inflammatory infiltrate, granulation tissue, and fibrosis. Ulcers that penetrate through the fibrotic tissue into the muscularis layer (muscularis mucosae) can perforate into the peritoneal cavity (peritonitis) or into the head of the pancreas. Arteries or veins in the muscularis layer may be eroded by ulcers (bleeding ulcer), giving rise to acute hemorrhage, anemia, and potential shock. Untreated ulcers often heal by fibrosis, which can lead to pyloric stenosis, gastric outlet obstruction, dehydration, and alkalosis. Complications are more common in older adults and those with comorbid liver, kidney, and malignant disease.²⁷ Approximately 5% of those with duodenal ulcers die annually as a result of such complications.²⁸

H. pylori is associated with the development of a low-grade gastric mucosa-associated lymphoid tissue (MALT) lymphoma.²⁹ Accordingly, *H. pylori* has been classified by the World Health Organization as a definite (class I) human carcinogen.³⁰

Peptic ulcers rarely undergo carcinomatous transformation. Ulcers of the greater curvature of the stomach have a greater propensity for malignant degeneration than do those of the duodenum. Eradication of *H. pylori* helps to halt the progression of atrophic gastritis and thus reduces the risk of malignant transformation.^{31,32}

CLINICAL PRESENTATION

Signs and Symptoms

Although many patients with active peptic ulcer report no ulcer symptoms, most experience epigastric pain that is long-standing (several hours), sharply localized, and recurrent. The pain is described as “burning” or “gnawing” but may be “ill-defined” or “aching.” The discomfort of a duodenal ulcer manifests most commonly on an empty stomach and frequently awakens the patient in the middle of the night. Ingestion of food, milk, or antacids provides rapid relief in most cases. In contrast, patients with gastric ulcers are unpredictable in their response to food; in fact, eating may precipitate abdominal pain. Epigastric tenderness often accompanies the condition.¹

Changes in the character of pain may indicate the development of complications. For example, increased discomfort, loss of antacid relief, or pain radiating to the back may signal deeper penetration or perforation of the ulcer. Protracted vomiting a few hours after a meal is a sign of gastric outlet (pyloric) obstruction. Melena (bloody stools) or black tarry stools indicate blood loss due to GI hemorrhage.

LABORATORY AND DIAGNOSTIC FINDINGS

A peptic ulcer is diagnosed primarily by fiberoptic endoscopic biopsy and laboratory testing for *H. pylori*.¹ During endoscopy, a biopsy of the marginal mucosa adjacent to the ulcer is performed to confirm the diagnosis and rule out malignancy. A rapid urease test is then performed to detect the bacterial product urease in the mucosal biopsy specimen. Microscopic analysis of biopsied tissue prepared with Giemsa, acridine orange, and Warthin-Starry stains is effective in the microscopic detection of *H. pylori* (Fig. 11.3). Culture of the organism is reserved for cases in which antimicrobial resistance is suspected because the technique is tedious, difficult, and no more sensitive than routine histologic analysis.

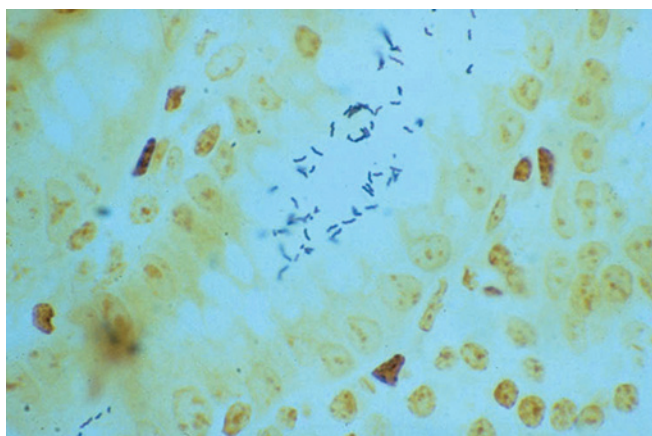

FIG 11.3 *Helicobacter pylori* organisms (dark rods) evident in the lumen of the intestine. (Warthin-Starry stain.) (Courtesy of Eun Lee, Lexington, KY.)

Nonendoscopic laboratory tests include urea breath tests (UBTs) and, less commonly, *H. pylori* fecal antigen tests. A UBT is a highly sensitive, noninvasive test that involves the ingestion of urea labeled with carbon-13 (¹³C) or carbon-14 (¹⁴C). Degradation of urea by the bacillus releases ¹³C or ¹⁴C in expired carbon dioxide.³³ These tests are advantageous because they indirectly measure the presence of *H. pylori* before treatment and its eradication after treatment. Upper GI imaging is infrequently performed because it lacks the sensitivity of biopsy. A low red blood count may occur in persons with a GI bleed.

MEDICAL MANAGEMENT

Most patients with PUD suffer for several weeks before going to a doctor for treatment. If the peptic ulcer is confined and uncomplicated and *H. pylori* is not present, an antisecretory drug, such as a proton pump inhibitor (PPI), is administered for 10 to 14 days (Table 11.2); treatment is for 4 or more weeks if complications occur. If the patient is infected with *H. pylori*, inhibitors of gastric acid secretion and at least two antimicrobial agents are recommended. Various treatment regimens are used, which vary by country and prevalence of *H. pylori* antibiotic resistance (Box 11.1).³⁴ The conventional regimen is “triple” therapy because antisecretory drugs, such as PPIs, provide rapid relief of pain and accelerate healing, and their use in combination with at least two antibiotics is effective in eradicating *H. pylori* in more than 90% of treated patients.^{1,35} Therapy is typically given for 10 to 14 days, and eradication of infection should be confirmed afterward because of growing antibiotic resistance. Quadruple therapy is used in areas where high prevalence of antimicrobial resistance occurs.

Before 2000, more than 50% of patients with PUD experienced recurrences after treatment. Such recurrence was likely because regimens consisting solely of antisecretory drugs were the treatment of choice; however, these drugs alone do not eradicate *H. pylori* infection and are noncurative of PUD. Eradication of *H. pylori* with antibiotic treatment reduces the rate of recurrence of peptic ulceration by 85% to 100%.³⁵ Reemergence of an ulcer usually is traced to the persistence of *H. pylori* after treatment because of inappropriate drug choice, discontinuance of drug therapy, lack of behavior modification, or bacterial resistance.²

In all patients who undergo peptic ulcer therapy, ulcerogenic factors (e.g., use of alcohol, aspirin or other NSAIDs, and corticosteroids; consumption of foods that aggravate symptoms and stimulate gastric acid secretion; persistent stress) should be eliminated to accelerate healing and limit relapses. Patients benefit from smoking cessation, that is perforation rates are higher in smokers, and continued smoking results in a higher relapse rate after treatment and lower rates of eradication of *H. pylori*.³⁵ When *H. pylori* is successfully eradicated, cigarette

TABLE 11.2 Antisecretory Drugs

Class	Drug	Trade Name	Dental Considerations
Histamine H ₂ receptor antagonists	Cimetidine	Tagamet	Delayed liver metabolism of benzodiazepines; reversible joint symptoms with preexisting arthritis
	Ranitidine	Zantac	—
	Famotidine	Pepcid	Anorexia, dry mouth
	Nizatidine	Axid	Potentially increased serum salicylate levels with concurrent aspirin use
Proton pump inhibitors (PPIs)	Omeprazole—rapid-release form	Prilosec, Zegarid	PPIs can reduce absorption of ampicillin, ketoconazole, and itraconazole; may increase the concentration of benzodiazepines, warfarin, and phenytoin. Dental providers should check drug interaction resources before prescribing anti-infective drugs in these patients.
	Lansoprazole	Prevacid	Can be associated with vitamin B ₁₂ deficiency
	Pantoprazole	Protonix, Protium	
	Rabeprazole	Aciphex	
	Esomeprazole	Nexium	
Prostaglandins*	Dexlansoprazole	Dexilant	
	Misoprostol	Cytotec	Diarrhea, cramps

*Not a first-line drug for treating patients with peptic ulcer disease (PUD). Used in the prevention of PUD and in users of nonsteroidal antiinflammatory drugs.

BOX 11.1 Antimicrobial Regimens for the Treatment of *Helicobacter pylori* Infection in Peptic Ulcer Disease

Triple Therapy

PPI (e.g., omeprazole 20 mg bid or lansoprazole 30 mg bid, esomeprazole 40 mg qd) *plus* clarithromycin* 500 mg bid (or metronidazole 500 mg bid) *and* amoxicillin 1 g bid for 10 to 14 days

PPI *plus* clarithromycin 500 mg bid *and* metronidazole 500 mg bid for 10 to 14 days

Bismuth compound qid *plus* tetracycline 500 mg qid *and* metronidazole 500 mg qid for 14 days

Quadruple Therapy

PPI (2 capsules of 30 mg of lansoprazole) *plus* 525 mg bismuth subsalicylate qid, 500 mg metronidazole tablet qid, *and* 2 g of amoxicillin suspension qid (or 500 mg tetracycline qid)

Salvage Therapy

A combination of levofloxacin 250–500 mg bid, amoxicillin 1000 mg bid, and a PPI bid for 10 to 14 days can be used as salvage therapy after unsuccessful attempts to eradicate *Helicobacter pylori* using other regimens.

*Avoid using a triple therapy regimen with clarithromycin if the clarithromycin resistance rate is >15% in the community. Patients with peptic ulcer disease testing negative for *H. pylori* should be treated with antisecretory agents: H₂ receptor antagonists (cimetidine, ranitidine, famotidine, and nizatidine) or a proton pump inhibitor (PPI).

bid, Twice a day; QD, every day; qid, four times a day.

Based on: Peptic ulcer disease. In *Ferri's clinical advisor*. 2016, 943-944, e1, Philadelphia, 2016, Elsevier and Peptic ulcer disease. In Greenberger N, Blumberg R, Burakoff, R editors: *Current diagnosis and treatment: gastroenterology, hepatology & endoscopy*, ed 3. New York, 2016, McGraw Hill <http://accessmedicine.mhmedical.com.ezproxy.uky.edu/ViewLarge.aspx?figid=105183359>.

smoking does not appear to increase the risk of recurrence.³⁶

Elective surgical intervention (e.g., dissection of the vagus nerves from the gastric fundus) largely has been abandoned in the management of PUD. Today, surgery is reserved primarily for complications of PUD such as significant bleeding (when unresponsive to coagulant endoscopic procedures), perforation, and gastric outlet obstruction. On occasions when PUD is associated with hyperparathyroidism and parathyroid adenoma, surgical removal of the affected gland is the treatment of choice. Resolution of GI disease occurs after abnormal endocrine function is terminated. Vaccines against *H. pylori* continue to be investigated.³⁷

DENTAL MANAGEMENT

Identification. The dental provider must identify intestinal symptoms through a careful history that is taken before dental treatment is initiated because many GI diseases, although they are chronic and recurrent, remain undetected for long periods. This history includes a careful review of medications (e.g., aspirin and other NSAIDs, oral anticoagulants) and level of alcohol consumption that may result in GI bleeding. If GI symptoms are suggestive of active disease, a medical referral is needed. When the patient returns from the physician and the condition is under control, the dentist should update current medications in the dental record, including the type and dosage, and should follow physician guidelines. Furthermore, periodic physician visits should be encouraged to afford early diagnosis and cancer screenings for at-risk patients.

Risk Assessment. The dentist is responsible for establishing the severity and stability of a patient with a known history of PUD. Severe disease or poor control is evident

by ongoing pain, blood in the stool, anemia, or recent physician visits or hospitalization in which medical treatment has not remedied the condition.

Recommendations

Antibiotics: Infection Risk. Antibiotics used during PUD therapy would likely keep most dental infections in check. However, the selection of antibiotics for dental issues may need to be altered based on the antibiotics used recently in the treatment of PUD.

Bleeding. Bleeding from oral tissues is not an issue with PUD. In contrast, GI bleeding associated with PUD can be of major concern and lead to significant complications that can delay dental treatment.

Capacity to Tolerate Care. Routine dental treatment may be provided during medical therapy for peptic ulceration; however, the decision should be based on patient comfort, convenience, and severity of disease. A patient with ongoing signs and symptoms of active PUD is not a candidate for routine dental care.

Drug Considerations. Of primary importance are the impact and interactions of certain drugs prescribed to patients with PUD (Box 11.2). In general, the dentist should avoid prescribing aspirin, aspirin-containing compounds, and other NSAIDs to patients with a history of PUD because of the irritative effects of these drugs on the GI epithelium. Acetaminophen and compounded acetaminophen products are recommended instead. If NSAIDs are used, a COX-2-selective inhibitor (e.g., celecoxib [Celebrex]) given in combination with a PPI or misoprostol (Cytotec), 200 µg four times per day—a prostaglandin E₁ analogue—is advised for short-term use to reduce the risk of GI bleeding.³⁸ Analgesic selection should be based on patient risk factors (previous GI bleeding; advanced age, use of alcohol, anticoagulants, or steroids) and the lowest dose for the shortest period to achieve the desired effect. Histamine H₂ receptor antagonists and sucralfate are not beneficial selections because they do not appear to protect patients from NSAID-induced complications.³⁹

Acid-blocking drugs, such as cimetidine, decrease the metabolism of certain dentally prescribed drugs (i.e., diazepam, lidocaine, tricyclic antidepressants) and enhance the duration of action of these medications (see Table 11.2). Under such circumstances, dosing of anesthetics, benzodiazepines, and antidepressants that are metabolized in the liver may require adjustment. Antacids also impair the absorption of tetracycline, erythromycin, oral iron, and fluoride, thereby preventing attainment of optimal blood levels of these drugs. To avoid this problem, antibiotics and dietary supplements should be taken 2 hours before or 2 hours after antacids are ingested.

Oral Complications and Manifestations

H. pylori is found in dental plaque and may serve as a reservoir of infection and reinfection along the alimentary tract.^{40,41} Good oral hygiene measures and periodic scaling

and prophylaxis may be useful in reducing the spread of this organism. The need for rigorous hygiene measures should be explained to the patient and consideration given to laboratory detection of oral organisms in patients who have a history of PUD and are symptomatic or are experiencing recurrences.

The use of systemic antibiotics for PUD may result in *fungal overgrowth* (candidiasis) in the oral cavity. The dentist should be alert to identifying oral fungal infections, including median rhomboid glossitis, in this patient population (Fig. 11.4). A course of antifungal agents (see Appendix C) should be prescribed to resolve the fungal infection.

Vascular malformations of the lip and *erosion of the enamel* are two less common oral manifestations of PUD. The former have been reported to range in size from a small macule (microcherry) to a large venous pool, and they typically occur in older men with PUD.⁴² Enamel erosion is the result of persistent regurgitation of gastric juices into the mouth when pyloric stenosis occurs (Fig. 11.5). The finding of such erosion combined with a history of reflux indicates that the patient must be evaluated by a physician.

Medications taken by patients for the treatment of PUD can produce oral manifestations. PPIs can alter taste perception. Cimetidine and ranitidine may have a toxic effect on bone marrow; infrequently, they cause anemia, agranulocytosis, or thrombocytopenia. Mucosal ulcerations may be a sign of agranulocytosis, anemia may manifest

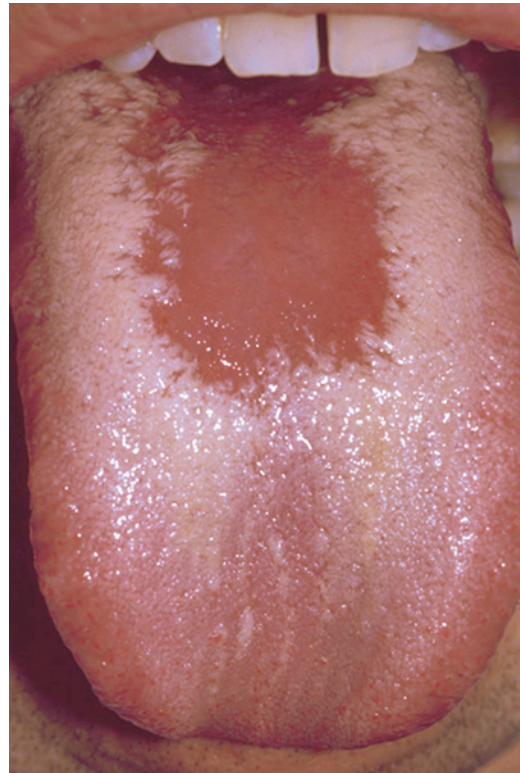

FIG 11.4 Median rhomboid glossitis caused by antibiotic use.

BOX 11.2 Dental Management Considerations in Patients With Gastrointestinal Disease

A**Awareness**

Dental treatment and dental drug administration can contribute to or worsen GI disease.

P**Patient Evaluation and Risk Assessment (see Table 1.1)**

- Evaluate and determine whether GI signs or symptoms (disease) or comorbid conditions exist.
- Obtain medical consultation if patient's disease is poorly controlled, if signs or symptoms appear suggesting an undiagnosed condition, or if the diagnosis is uncertain.

Potential Issues and Factors of Concern**A**

Analgesics	Avoid prescribing aspirin, aspirin-containing compounds, and other NSAIDs for patients with a history of PUD or IBD. Use acetaminophen-containing products or celecoxib (Celebrex) in combination with a PPI or misoprostol (Cytotec).
Antibiotics	Selection of antibiotics for oral infections may be influenced by recent use of antibiotics for PUD; certain drugs can increase the risk of intestinal flare-up in patients with IBD. Avoid long-term use of antibiotics, especially in older and debilitated persons, to minimize the risk of pseudomembranous colitis. Monitor for signs or symptoms (diarrhea, GI distress) suggestive of pseudomembranous colitis or disease worsening. Contact patient's physician if GI symptoms worsen while patient is on antibiotics so that alternative therapies can be initiated.
Anesthesia	No issues
Anxiety	Intraoperative sedation can be provided by an oral, inhalation, or intravenous route.

B

Bleeding	Concurrent use of acid-blocking drugs and PPIs with warfarin (Coumadin) can enhance blood levels of the anticoagulant. Obtain CBC if medication profile increases patient risk for anemia, leukopenia, thrombocytopenia, or bleeding.
Blood pressure	No issues

C

Chair position	Chair position should be based on patient comfort relative to the GI disorder or comorbidities.
----------------	---

D

Devices	No issues
Drugs	Lower doses of diazepam, lidocaine, or TCAs may be required if the patient is taking acid-blocking drugs, such as cimetidine, which decreases the metabolism of some dentally prescribed drugs and enhances the duration of action of these medications. PPIs may reduce absorption of select antibiotics and antifungals. Monitor effects of immunosuppressant medications. If patient has recently taken corticosteroids, dosage modification generally is not needed; however, the clinician should evaluate the need for supplemental steroids as indicated by health status, level of anxiety or fear, presence of infection, and invasiveness of the dental procedure (see Box 15.2).

E

Equipment	No issues
Emergencies and urgent care	No issues

F

Follow-up	Schedule appointments during periods of remission. Be flexible in scheduling appointments; disease flare-ups can be unpredictable. Shorter appointments may be necessary. Increased risk for medical complications could affect scheduling—for example: <ul style="list-style-type: none"> • PUD is more likely in patients older than 65 years of age and those with previous history of ulcer complications; prolonged use of NSAIDs; and concomitant use of anticoagulants, corticosteroids, or bisphosphonates. • IBD flare-ups are more likely when the patient is reporting symptoms and has a fever. • Pseudomembranous colitis is more likely in patients older than 65 years of age and those with history of recent hospitalization or taking broad-spectrum antibiotics (clindamycin, cephalosporins, ampicillin) or multiple antibiotics or with HIV-seropositive status associated with immune suppression. • Patients with persistent <i>Helicobacter pylori</i> are at increased risk for MALT lymphoma; patients with Crohn disease or ulcerative colitis are at increased risk for colon cancer. Routine physician evaluation of these patients is advised.
-----------	---

CBC, Complete blood count; GI, gastrointestinal; IBD, inflammatory bowel disease; MALT, gastric mucosa-associated lymphoid tissue; NSAID, nonsteroidal antiinflammatory drug; PPI, proton pump inhibitor; PUD, peptic ulcer disease; TCA, tricyclic antidepressant.



FIG 11.5 Perimylolysis. Destruction of palatal enamel of maxillary incisors in a patient with persistent regurgitation.

as mucosal pallor, and thrombocytopenia as gingival bleeding or petechiae. Xerostomia has been associated with the use of famotidine and anticholinergic drugs, such as propantheline (Pro-Banthine). A chronic dry mouth renders the patient susceptible to bacterial infection (caries and periodontal disease) and fungal disease (candidiasis). Erythema multiforme has been associated with the use of cimetidine, ranitidine, omeprazole, and lansoprazole.

INFLAMMATORY BOWEL DISEASE

Inflammatory bowel disease is a term encompassing two idiopathic diseases of the GI tract: ulcerative colitis and Crohn disease. The main criteria that separate the two diseases are the site and extent of tissue involvement; thus, it is logical to consider these clinical entities together. *Ulcerative colitis* is a mucosal disease that is limited to the large intestine and rectum. In contrast, *Crohn disease* is a transmural process (involving the entire thickness of the bowel wall) that may produce “patchy” ulcerations at any point along the alimentary canal from the mouth to the anus but most commonly involves the distal ileum and proximal colon.

EPIDEMIOLOGY

The incidence and prevalence of IBD vary widely by race and geographic location. Occurrence is much higher among Jews and whites than in blacks, and it is considerably higher in the United States and northern and western Europe than in Africa and Asia, although the incidence is rising in Asia.⁴³ Fifteen to 25 new cases of IBD per 100,000 people are diagnosed annually in the United States, Australia, and Europe,^{44,45} and currently a more than 1 million people in the United States are affected.⁴⁶ Peak age at onset is 20 to 40 years (young adulthood). However, a second incidence peak for Crohn disease has been noted in the seventh decade. Children are known to develop IBD, and the incidence in this population is

rising.⁴⁷ Crohn disease and ulcerative colitis affect men and women equally. A 10-fold increased risk of disease in first-degree relatives of patients strongly suggests that genetic factors are involved.⁴⁸ Environment factors also are contributory: Crohn disease occurs more often in smokers, but smoking protects against ulcerative colitis.⁴³ Breastfeeding also appears to reduce the risk of IBD.⁴⁹ In the average general dentistry practice with 2000 adult patients, approximately 5 adults are predicted to have IBD.

ETIOLOGY

Ulcerative colitis and Crohn disease are inflammatory diseases of unknown cause that are generally thought to be associated with immune dysfunction in response to environmental factors in genetically susceptible persons. Numerous genetic susceptibility genes have been identified, including *Nod2*, *ATG16L1*, interleukin (IL)-23 receptor gene, tumor necrosis factor (TNF) superfamily (TNFSF15) gene, and Toll-like receptor (TLR)-4 gene. Mutations in these genes impair the immune response and/or cellular homeostasis, thereby contributing to inefficient recognition and clearing of bacteria and cell degradation products by intestinal epithelium leading to inflammation and increased permeability of the intestinal wall.^{50,51} At present, no specific enteric microbe has been determined to be responsible for inducing the proinflammatory responses observed in IBD; however, microbial diversity is reduced in patients with active IBD.

PATHOPHYSIOLOGY AND COMPLICATIONS

Both ulcerative colitis and Crohn disease are the result of a dysregulated innate immune response to commensal bacteria that triggers T cells (T_H 17) and a humoral (antibody) response.

Ulcerative Colitis. Ulcerative colitis is an inflammatory disease that targets the large intestine characterized by remissions and exacerbations. It starts in the colon and rectum region and may spread proximally to involve the entire large intestine. Histopathologic findings include epithelial necrosis, edema, vascular congestion, distorted crypt architecture, and monocellular infiltration. Persistent disease causes epithelial erosions and hemorrhage, pseudopolyp formation, crypt abscesses, and submucosal fibrosis. Chronic deposition of fibrous tissue may lead to fibrotic shortening, thickening, and narrowing of the colon.

Ulcerative colitis usually is a lifelong disease, and progression to its more severe forms predisposes affected persons to toxic dilatation (toxic megacolon) and dysplastic changes (carcinoma) of the intestine. *Toxic megacolon* is the result of disease extension through deep muscular layers. The colon dilates because of weakening of the wall, and intestinal perforation then becomes likely. Associated fever, electrolyte imbalance, and volume depletion are reported. *Carcinoma of the colon* is 10 times

more likely in patients with ulcerative colitis than in the general population. Likelihood of malignant transformation increases with proximal extension of involvement and with long-standing disease (>8–10 years), at a rate of 0.5% to 2% per year.⁵²

Crohn Disease. Crohn disease is a chronic, relapsing idiopathic disease that is characterized by segmental distribution of intestinal mucosal ulcers (so-called “skip lesions”) interrupted by normal-appearing mucosa. Although the distal ileum and the proximal colon are affected most frequently, any portion of the bowel may be involved. In gross specimens, the intestine displays sharply noncontinuous regions of thickened bowel wall, irregular glandular openings, mucosal fissuring, ulcerations, erosions, and benign strictures (Fig. 11.6). With chronic disease, the intestinal mucosa takes on a nodular or “cobblestone” appearance as a result of dense inflammatory infiltrates and submucosal thickening. Transmural involvement of the intestinal wall and noncaseating epithelioid granulomas of the intestine and mesenteric lymph nodes are classic features of the disease. As a result, the mesentery thickens and fixes the intestine in one

position. Mesenteric fat tissue contributes numerous immune-regulating adipokines that influence the disease process.⁵³

At the microscopic level, ulcerative colitis and Crohn disease are characterized by infiltrative lesions of the bowel wall that contain activated inflammatory cells (neutrophils and macrophages), immune-based cells (lymphocytes and plasma cells), and noncaseating granulomas.⁵⁴ Crohn disease is further characterized by defects in mucosal immunity and in the mucosal barrier that result in increased intestinal permeability, increased adherence of bacteria, and decreased expression of defensins.⁴⁷ The clinical course in Crohn disease consists of remissions and relapses; relapses are more common in persons who smoke tobacco. Unremitting disease is complicated by small bowel stenosis and fistula formation. Most patients who have Crohn disease require at least one operation for their condition.⁴² Long-standing colonic Crohn disease increases the risk for the development of colorectal cancer.

CLINICAL PRESENTATION

Signs and Symptoms

Ulcerative Colitis. Patients with ulcerative colitis experience three prominent symptoms: (1) attacks of diarrhea, (2) rectal bleeding (or bloody diarrhea), and (3) abdominal cramps. Onset may be sudden or insidious, but in most cases, the disease continues along a chronic intermittent course. Dehydration, fatigue, weight loss, and fever caused by malabsorption of water and electrolytes frequently accompany the condition. Extraintestinal manifestations may include arthritis, erythema nodosum or pyoderma gangrenosum, eye disorders such as iritis and uveitis, and growth failure. Although many patients enjoy long periods of remission, fewer than 5% remain symptom-free over a 10-year period; about 50% experience a relapse in any given year.⁵⁵

Crohn Disease. Initial manifestations of Crohn disease consist of recurrent or persistent diarrhea (often without blood), right lower quadrant abdominal pain or cramping, anorexia, and weight loss. Unexplained fever, malaise, arthritis, uveitis, and features related to malabsorption often emerge next. However, symptoms vary from patient to patient according to the site and extent of involved tissue, with three major patterns recognized: (1) disease of the ileum and cecum, (2) disease confined to the small intestine, and (3) disease confined to the colon. Variability in symptoms and the episodic pattern contribute to the average 3-year delay in diagnosis from onset of symptoms.⁵⁴ Intestinal complications from chronic inflammatory damage include transmural fibrosis, intestinal fissuring, and formation of fistulas or abscesses. These complications are common; 70% to 80% of patients require surgery within their lifetime. Malabsorption is an additional complication that can result in a striking degree of weight loss, growth failure, anemia, and clubbing of the fingers. Reduced bone mineral density (i.e., osteoporosis) also

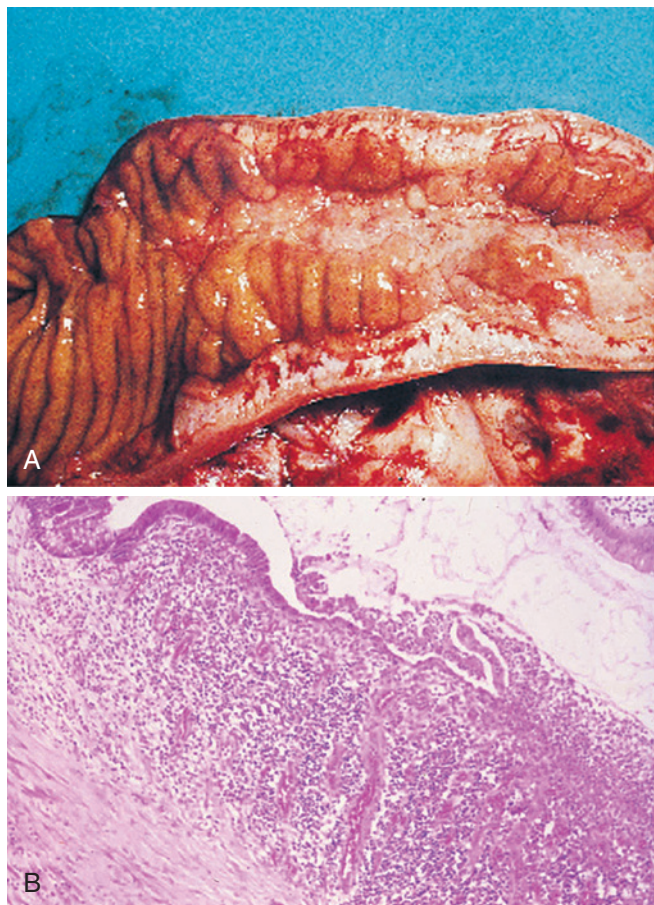

FIG 11.6 A, Crohn disease that exhibits ulceration of the intestinal mucosa. **B**, Low-power micrograph showing ulcerated intestinal mucosa of Crohn disease with dense inflammatory infiltrate. (A, From MC, Dhillon AP, Lewis WG, et al: *Inflammatory bowel disease*, London, 1998, Mosby.)

results from malabsorption and chronic corticosteroid use. Extraintestinal manifestations (e.g., peripheral arthritis, erythema nodosum, aphthous, uveitis, episcleritis, hepatic complications) occur in about 20% of patients.⁴⁸

LABORATORY AND DIAGNOSTIC FINDINGS

The diagnosis of IBD is based primarily on clinical findings, results of endoscopy and biopsy, and observations on histopathologic examination of intestinal mucosa. Abdominal radiographic imaging, including computed tomography and magnetic resonance enterography, and stool examinations also may provide supportive evidence.⁴⁸

Endoscopic and histopathologic evaluation of ulcerative colitis show friable, granular, erythematous, and eroded mucosa of the colon, with regions of edema and chronic inflammation. Crohn disease, in contrast, features patchy erosions and ulcerations, with noncaseating granulomas that can arise in any part of the GI tract. Blood tests in IBD may show anemia (deficiencies of iron, folate, or vitamin B₁₂) caused by malabsorption, decreased levels of serum total protein and albumin (as a result of malabsorption), inflammatory activity (evidenced as elevated erythrocyte sedimentation rate and increased C-reactive protein titer), and an elevated platelet or leukocyte count in conjunction with a negative microbial stool sample. Anti-*Saccharomyces cerevisiae* (yeast) antibodies are elevated in 40 to 70% of patients who have Crohn disease but in fewer than 15% of those with ulcerative colitis.

MEDICAL MANAGEMENT

Ulcerative colitis and Crohn disease can be managed by an array of drugs but not cured. Antidiarrheal and antiinflammatory medications (e.g., sulfasalazine, 5-aminosalicylic acid [5-ASA], corticosteroids) generally are first-line drugs.^{48,55} Immunosuppressive agents and antibiotics are used as second-line drugs. Third-line approaches for management of Crohn disease in persons who are refractory to steroid treatment include biologic agents such as monoclonal antibody (infliximab [Remicade]) against TNF or a specific interleukin and if needed surgical resection to remove the diseased portion of the colon. Supportive therapy including bedrest, dietary manipulation, and nutritional supplementation often is required. Dietary intervention with fish oil supplements may be beneficial to persons with Crohn disease.⁵⁶

Drugs containing 5-ASA remain the mainstay of treatment for ulcerative colitis and play a small role in management of Crohn disease.^{48,57} These drugs—sulfasalazine, mesalamine (Asacol [Procter & Gamble Pharmaceuticals, Cincinnati, OH]), Pentasa [Shire US Inc., Wayne, PA]), olsalazine, and balsalazide—are covalently bound to 5-ASA, which is released when cleaved by colonic bacteria. The released 5-ASA delivers local antiinflammatory effects within the intestine. Because use of sulfasalazine is associated with adverse effects (nausea, headache, fever,

arthralgia, rash, anemia, agranulocytosis, cholestatic hepatitis) and because this agent is not well delivered past the proximal bowel, controlled-release oral formulations of 5-ASA (mesalamine, olsalazine, and balsalazide) that dissolve in the distal ileum and colon are used; rectal suppositories or enemas also are used. Of note, 5-ASA drugs are potentially nephrotoxic, so physician monitoring of renal function is advised.

Corticosteroids often are combined with sulfasalazine to induce remission in patients who are experiencing flare-ups. Steroids are not prescribed for maintenance therapy because several adverse effects are associated with long-term use. When severe attacks produce abdominal tenderness, dehydration, fever, vomiting, and severe bloody diarrhea, the patient should be hospitalized and parenteral corticosteroids administered. After about 2 weeks, or when a satisfactory response is achieved, oral steroids are substituted for parenteral steroids, and the dosage is gradually reduced until the drug is no longer needed.

Immunomodulator drugs such as azathioprine (Imuran), its metabolite 6-mercaptopurine, methotrexate, or cyclosporine are used in patients who have active disease that is unresponsive to corticosteroids and in corticosteroid-dependent patients to reduce the amount of steroid needed and to limit dose-dependent adverse effects of steroids.⁵⁷ Immunomodulators may be given for years; however, their use is limited by their toxicity (flulike symptoms, leukopenia, pancreatitis, hepatitis, and life-threatening infections); thus, white blood cell count and liver function tests must be monitored routinely. Bone marrow and hematopoietic stem cell transplantation has been associated with permanent remission.^{58,59}

Several biologics are used to manage IBD, including anti-TNF monoclonal antibody therapy (infliximab, adalimumab, and golimumab), as well as natalizumab (anti- α_4 -integrin) and vedolizumab (anti- $\alpha_4\beta_7$ -integrin). Their use is generally reserved for severe disease (more than one relapse per year) that is refractory to other drugs and for maintenance of remission.⁶⁰ These drugs are expensive and require either slow intravenous (IV) infusion (infliximab, natalizumab, vedolizumab) generally performed at 8-week intervals or subcutaneous injections every 2 to 4 weeks.⁶¹ Greater efficacy and a lower rate of side effects occur when biologics are given in combination with other antiinflammatory and immunomodulator drugs.

Antibiotics (metronidazole or ciprofloxacin) have been used for treatment of active Crohn disease (e.g., abscesses) and to maintain remission. They also are used after surgery when toxic colitis develops or when fever and leukocytosis are present. Additional medications such as opioids, cromolyn sodium, and supplemental iron sometimes are used for their different effects, as required: antidiarrheal, anti-mast cell release, and treatment of anemia, respectively.

Surgery is recommended for severe cases of IBD that do not respond to corticosteroids and to manage serious

complications (e.g., massive hemorrhage, obstruction, perforation, toxic megacolon, carcinomatous transformation). Total proctocolectomy with ileostomy is the standard but infrequent treatment for intractable ulcerative colitis. Approximately 50% of patients with Crohn disease require some form of surgery within 10 years of diagnosis, and 40% have recurrent disease, thus necessitating additional resections.⁶²

DENTAL MANAGEMENT

Identification and Risk Assessment. The dentist should identify those with GI signs and symptoms and make a referral to a physician for further evaluation. The dentist should also evaluate the patient with IBD to determine the severity and level of control of the condition. The severity of disease can be assessed by taking the patient's temperature and by reviewing the patient's symptoms to ascertain the number of diarrheal bowel movements occurring per day and whether blood is present in the stool. Patients who have less than four bowel movements per day with little or no blood, no fever, few symptoms, and a sedimentation rate below 20 mm/hr are considered to have mild disease and can receive dental care in the dentist's office. Patients with moderate disease (i.e., between mild and severe) or severe disease—the latter defined as having six or more bowel movements per day with blood, fever, anemia, and a sedimentation rate higher than 30 mm/hr—are poor candidates for dental care and should be referred to their physicians.

Recommendations

Antibiotics: Risk of Infection. The majority of patients who have IBD are at low risk for infection; however, persons taking immunosuppressive therapy in conjunction with biologics are at increased risk of infection. Another concern to the dentist is the administration of antibiotics in this population. Some antibiotics can promote overgrowth of *Clostridium difficile*, leading to symptomatic flares and diarrhea (see next section). Although data on specific antibiotics and flares in this patient population are lacking, clindamycin and penicillins have documented association with pseudomembranous colitis. Dentists who provide antibiotics are encouraged to minimize the use of clindamycin, if possible, and should advise the patient to report a symptomatic flare (diarrhea) so that the physician can be alerted to check for *C. difficile*, with consequent modification of therapy as appropriate.

Appointments. The severity, clinical course, and ultimate prognosis of IBD are highly variable and can have an impact on routine dental care. Most patients with IBD experience intermittent attacks, with asymptomatic remissions between attacks. Patients often require physical rest and emotional support throughout the disease because anxiety and depression may be severe. Only urgent dental care is advised during acute exacerbations of GI disease. Elective dental procedures should be scheduled during

periods of remission when complications are absent and a feeling of well-being has returned. Flexibility in appointment scheduling may be required because of the unpredictability of the disease.

Bleeding. Bleeding generally is not an issue with these patients unless a flare-up is accompanied by thrombocytopenia or one or more of the immunosuppressant drugs taken by the patient cause thrombocytopenia. When elective surgical procedures are scheduled for patients with IBD who take sulfasalazine, the dentist should review preoperatively the patient's systemic health and obtain a complete blood count with differential and bleeding times. This preoperative assessment can be important because in addition to the immunosuppressive effects of IBD medications, sulfasalazine is associated with pulmonary, nephrotic, and hematologic abnormalities (i.e., a variety of anemias, leukopenia, and thrombocytopenia).

Capacity to Tolerate Care. The use of a steroid drug by a patient with IBD can be of clinical concern because corticosteroids can suppress adrenal function and reduce the ability of the patient to withstand stress. Current guidelines recommend that the patient take the usual daily dose of corticosteroids before the dental appointment and that the dentist provide adequate pain and anxiety control (see [Box 15.1](#)). Supplemental corticosteroids may be required in rare circumstances if the patient's health is poor, infection is present, the patient is fearful, and surgery is being performed (see [Chapter 15](#)).

Drug Considerations. Patients with IBD are likely to be taking antiinflammatory drugs, corticosteroids, or immunomodulators, which can have an impact on dental care. The use of antiinflammatory drugs and the involvement of the intestinal tract suggest that aspirin and other NSAIDs are to be avoided. Acetaminophen may be used alone or in combination with opioids. Alternatively, cotherapy with a COX-2 inhibitor (celecoxib) and a PPI can provide pain relief and simultaneous protection of the GI mucosa. A careful drug history should be obtained to avoid prescribing additional opioids to patients who take these medications to manage their intestinal pain (see [Box 11.2](#)).

Immunosuppressors (azathioprine and 6-mercaptopurine) are associated with the development of pancytopenia in approximately 5% of patients. In addition, a thorough head and neck examination should be performed in patients who take immunosuppressants because of their increased risk for lymphoma and infection (e.g., infectious mononucleosis, recurrent herpes). The presence of fever without an obvious causative illness in this select patient population mandates prompt referral to the physician.

Oral Complications and Manifestations

Several oral complications have been associated with IBD. Aphthous-like lesions occur in up to 20% of patients with ulcerative colitis ([Fig. 11.7](#)). Oral lesions erupt generally during GI flare-ups. The ulcers are mildly painful and may be of the major or minor variety. They typically

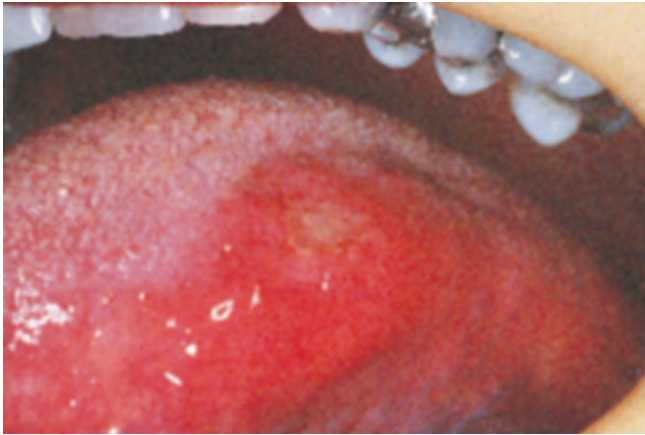

FIG 11.7 Oral ulceration associated with ulcerative colitis. (From Allison MC, Dhillon AP, Lewis WG, et al: *Inflammatory bowel disease*, London, 1998, Mosby.)

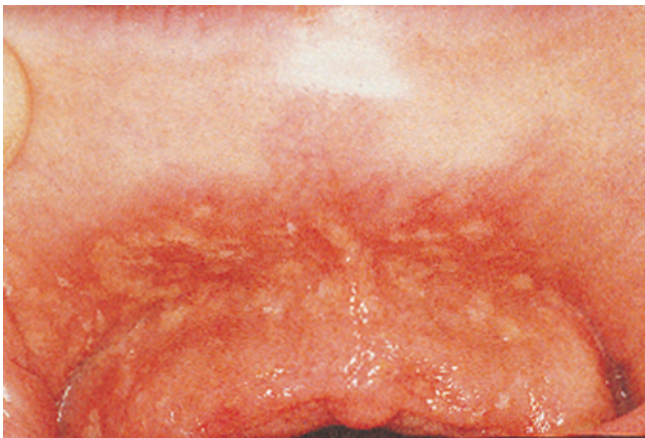

FIG 11.8 Pyostomatitis vegetans. Pustular raised lesions of palate in a patient with ulcerative colitis. (From Allison MC, Dhillon AP, Lewis WG, et al: *Inflammatory bowel disease*, London, 1998, Mosby.)

are located on the alveolar, labial, and buccal mucosa, as well as the soft palate, uvula, and retromolar trigone, and they may be difficult to distinguish from aphthous lesions. Granularity or presence of irregular margins may be helpful in the diagnosis.

Pyostomatitis vegetans also can affect patients with ulcerative colitis and may aid in the diagnosis. To date, fewer than 60 cases have been reported in the literature.⁶³ This form of stomatitis produces raised papillary, vegetative projections or pustules on an erythematous base of the labial mucosa, gingiva, and palate (Fig. 11.8). The tongue rarely is involved. Without treatment, the initial erythematous appearance worsens, with eventual degeneration into an ulcerative and suppurative mass. Treatment of both the aphthous-like lesions and pyostomatitis vegetans requires medical control of the colitis. Oral lesions that persist after antiinflammatory drug therapy typically respond to repeated topical steroid applications. The vegetative growths can be eradicated by surgical means.

Unique oral manifestations of Crohn disease occur in approximately 20% of patients and may precede the diagnosis of GI disease by several years. Features include atypical mucosal ulcerations and diffuse swelling of the lips and cheeks (orofacial granulomatosis). Oral ulcers appear as linear mucosal ulcers with hyperplastic margins or papulonodular “cobblestone” proliferations of the mucosa, often in the buccal vestibule and on the soft palate. Oral lesions are intermittent but chronically present. They become symptomatic when intestinal disease is exacerbated.⁶⁴ Similar to the oral lesions associated with ulcerative colitis, oral ulcerations of Crohn disease resolve when the GI state is medically controlled. Topical steroids are beneficial during symptomatic phases.

Use of sulfasalazine has been associated with toxic effects on bone marrow, resulting in anemia, agranulocytosis, or thrombocytopenia, which can manifest as a bald tongue, an oral infection, or bleeding, respectively. Corticosteroid use can result in osteopenia, which may involve the alveolar bone. Additional information on the oral management of these abnormalities is found in Appendix C.

PSEUDOMEMBRANOUS COLITIS

Pseudomembranous colitis is a severe and sometimes fatal form of colitis that results from the overgrowth of *C. difficile* in the large colon. Overgrowth results from the loss of competitive anaerobic gut bacteria, most commonly through the use of broad-spectrum antibiotics, but it also can result from heavy metal intoxication, sepsis, and organ failure. The causative organism, *C. difficile*, produces and releases potent enterotoxins that induce colitis and diarrhea. Rarely, other pathogenic microbes may cause pseudomembranous colitis.^{65,66}

EPIDEMIOLOGY

Pseudomembranous colitis is the most common nosocomial infection of the GI tract.⁶⁶ The incidence is about 50 cases per 100,000 persons in the United States and is rising.^{65,67} The reported incidence varies with the type and frequency of antibiotic exposure. No gender predilection exists; however, the disease is most common in older adults, patients in hospitals and nursing homes, those who receive tube feeding, and those who have suppressed immune systems.^{65,67} Infants and young children rarely are affected.

ETIOLOGY

C. difficile, the causative agent in 90% to 99% of pseudomembranous colitis cases, is a gram-positive, spore-forming anaerobic rod that has been found in sand, soil, and feces. Spores may survive on contaminated surfaces for months and are relatively resistant to many disinfectants. *C. difficile* colonizes the gut in 2% to 3% of asymptomatic adults and up to 50% of older adults.⁶⁶

The risk of disease increases in areas where spores are inhaled (e.g., hospitals, farmyards) and when broad-spectrum antibiotics are in prolonged use. Risk also increases with obesity, concurrent irritable bowel disease, and use of PPIs.⁶⁸ The most frequently offending antimicrobial agents are broad-spectrum agents and those that target anaerobic flora of the colon. The highest risk is associated with clindamycin (2%–20% of usage) or ampicillin or amoxicillin (5%–9% of usage) and third-generation cephalosporins (<2% of usage). Macrolides, penicillins, trimethoprim–sulfamethoxazole (Bactrim, Septra), and tetracycline are involved less frequently, and aminoglycosides, antifungal agents, metronidazole, and vancomycin are rarely causative. In general, oral antibiotics are more often causative than parenteral antibiotics.^{65,69}

PATHOPHYSIOLOGY AND COMPLICATIONS

As commensal intestinal bacteria are eliminated, *C. difficile* overgrows and produces enzymes that mediate tissue degradation, as well as three toxins, A, B, and a binary toxin that bind to intestinal mucosal cells, resulting in cytoskeletal disaggregation and altered vascular permeability, respectively. As cells (enterocytes) die, fluid is lost, and microscopic and macroscopic pseudomembranes form in the distal colon. Mild disease is characterized by patchy distribution; severe disease manifests with large, coalescent plaques and extensive denuded areas (Fig. 11.9). Histopathologic findings include epithelial necrosis; distended goblet cells; leukocyte infiltration of the lamina propria; and pseudomembranous plaques consisting of inflammatory cells, mucin, fibrin, and sloughed mucosal cells. Complications include recurrences, perforation, toxic megacolon, and death.⁶⁶

CLINICAL PRESENTATION

Signs and Symptoms

Although the course of illness can be variable, diarrhea is the most common presenting manifestation of pseudomembranous colitis. In mild cases, the stool is watery and loose. In severe cases, bloody diarrhea is accompanied by abdominal pain, cramping, and fever. Diarrhea often begins within the first 4 to 10 days of antibiotic administration but may develop 1 day to 8 weeks after drug administration. Severe dehydration, metabolic acidosis, hypotension, peritonitis, and toxic megacolon are serious complications of untreated disease.

LABORATORY AND DIAGNOSTIC FINDINGS

Pseudomembranous colitis is associated with leukocytosis, leukocyte-laden stools, and a stool sample positive for *C. difficile* or one of its toxins, as determined by tissue culture assay or enzyme immunoassay. Colonic yellow-white pseudomembranes that are 5 to 10 mm in diameter often are visible on colonoscopy or sigmoidoscopy.



FIG 11.9 Pseudomembranous colitis from *Clostridium difficile* infection. **A**, Gross photograph showing plaques of yellow fibrin and inflammatory debris adhering to a reddened colonic mucosa. **B**, Low-power micrograph showing superficial erosion of the mucosa and adherent pseudomembrane of fibrin, mucus, and inflammatory debris. (From Kumar V, et al, editors: *Robbins & Cotran pathologic basis of disease*, ed 8, Philadelphia, 2010, Saunders.)

MEDICAL MANAGEMENT

First-line treatment of pseudomembranous colitis involves discontinuing use of the offending antimicrobial agent along with introducing an antibiotic that will eradicate the toxin-producing *C. difficile*.⁷⁰ In patients with mild disease, cessation of the offending antibiotic is all that may be needed. In moderate disease, oral metronidazole (Flagyl) (500 mg three times a day for 10–14 days) is recommended. Vancomycin (125–500 mg four times a day for 10–14 days) is recommended for patients whose disease is severe or unresponsive to metronidazole.^{66,71} However, *C. difficile* spores can survive treatment, and relapse occurs in more than 20% of patients. Hydration and IV fluids are provided to correct electrolyte and fluid imbalances. Recurrences are managed with vancomycin, fidaxomicin, or rifaximin, with or without probiotics or alternatively with fecal bacteriotherapy.

Dental Management Recommendations

Antibiotics. The practitioner should be cognizant that the use of certain systemic antibiotics—especially clindamycin, ampicillin, and cephalosporins—is associated with a higher risk of pseudomembranous colitis in older, debilitated patients and in those with a previous history of pseudomembranous colitis (see Box 11.2). The risk increases

with higher doses, longer duration of administration, and greater number of antimicrobials used. The decision to use an antibiotic and the duration of use should be based on sound clinical judgment that these drugs are indeed necessary and should not be prescribed in a cavalier manner. The dentist also should be aware that pseudomembranous colitis has been reported after short-term use of clindamycin in the American Heart Association prophylactic regimen.⁷²

Appointment. Elective dental care should be delayed until after pseudomembranous colitis has resolved.

Drug Considerations and Oral Manifestations

The use of systemic antibiotics for the treatment of patients with pseudomembranous colitis can result in fungal overgrowth (candidiasis) in the oral cavity (see Fig. 11.4). Metronidazole can cause peripheral neuropathy, nausea and a metallic taste.

REFERENCES

- Kuipers E, Blaser M. Acid peptic disease. In: Goldman L, Schafer A, eds. *Goldman-Cecil Medicine*. Philadelphia: Saunders/Elsevier; 2016:908-918.
- Yuan Y, Padol IT, Hunt RH. Peptic ulcer disease today. *Nat Clin Pract Gastroenterol Hepatol*. 2006;3(2):80-89.
- Zagari RM, Eusebi LH, Rabitti S, et al. Prevalence of upper gastrointestinal endoscopic findings in the community: a systematic review of studies in unselected samples of subjects. *J Gastroenterol Hepatol*. 2016.
- Shaheen NJ, Hansen RA, Morgan DR, et al. The burden of gastrointestinal and liver diseases, 2006. *Am J Gastroenterol*. 2006;101(9):2128-2138.
- Xia B, Xia HH, Ma CW, et al. Trends in the prevalence of peptic ulcer disease and *Helicobacter pylori* infection in family physician-referred uninvestigated dyspeptic patients in Hong Kong. *Aliment Pharmacol Ther*. 2005;22(3):243-249.
- Hollander D, Tarnawski A. Is there a role for dietary essential fatty acids in gastroduodenal mucosal protection? *J Clin Gastroenterol*. 1991;13(suppl 1):S72-S74.
- Lam SK. Differences in peptic ulcer between East and West. *Baillieres Best Pract Res Clin Gastroenterol*. 2000;14(1):41-52.
- Sonnenberg A, Everhart JE. The prevalence of self-reported peptic ulcer in the United States. *Am J Public Health*. 1996;86(2):200-205.
- Huang ES, Strate LL, Ho WW, et al. Long-term use of aspirin and the risk of gastrointestinal bleeding. *Am J Med*. 2011;124(5):426-433.
- Voutilainen M, Mantynen T, Farkkila M, et al. Impact of non-steroidal anti-inflammatory drug and aspirin use on the prevalence of dyspepsia and uncomplicated peptic ulcer disease. *Scand J Gastroenterol*. 2001;36(8):817-821.
- Drumm B, Rhoads JM, Stringer DA, et al. Peptic ulcer disease in children: etiology, clinical findings, and clinical course. *Pediatrics*. 1988;82(3 Pt 2):410-414.
- Borum ML. Peptic-ulcer disease in the elderly. *Clin Geriatr Med*. 1999;15(3):457-471.
- Chiu HM, Wu MS, Hung CC, et al. Low prevalence of *Helicobacter pylori* but high prevalence of cytomegalovirus-associated peptic ulcer disease in AIDS patients: comparative study of symptomatic subjects evaluated by endoscopy and CD4 counts. *J Gastroenterol Hepatol*. 2004;19(4):423-428.
- Graham DY. *Helicobacter pylori* infection in the pathogenesis of duodenal ulcer and gastric cancer: a model. *Gastroenterology*. 1997;113(6):1983-1991.
- Marshall BJ, Warren JR. Unidentified curved bacilli in the stomach of patients with gastritis and peptic ulceration. *Lancet*. 1984;1(8390):1311-1315.
- Nakajima S, Nishiyama Y, Yamaoka M, et al. Changes in the prevalence of *Helicobacter pylori* infection and gastrointestinal diseases in the past 17 years. *J Gastroenterol Hepatol*. 2010;25(suppl 1):S99-S110.
- Tan VP, Wong BC. *Helicobacter pylori* and gastritis: untangling a complex relationship 27 years on. *J Gastroenterol Hepatol*. 2011;26(suppl 1):42-45.
- Malaty HM, Evans DG, Evans DJ Jr, et al. *Helicobacter pylori* in Hispanics: comparison with blacks and whites of similar age and socioeconomic class. *Gastroenterology*. 1992;103(3):813-816.
- Levenstein S, Rosenstock S, Jacobsen RK, et al. Psychological stress increases risk for peptic ulcer, regardless of *Helicobacter pylori* infection or use of nonsteroidal anti-inflammatory drugs. *Clin Gastroenterol Hepatol*. 2015;13(3):498-506. e1.
- Zullo A, Hassan C, Campo SM, et al. Bleeding peptic ulcer in the elderly: risk factors and prevention strategies. *Drugs Aging*. 2007;24(10):815-828.
- Modi A, Siris ES, Steve Fan CP, et al. Gastrointestinal events among patients initiating osteoporosis therapy: a retrospective administrative claims database analysis. *Clin Ther*. 2015;37(6):1228-1234.
- Leoci C, Ierardi E, Chiloiro M, et al. Incidence and risk factors of duodenal ulcer. A retrospective cohort study. *J Clin Gastroenterol*. 1995;20(2):104-109.
- Kikendall JW, Evalul J, Johnson LF. Effect of cigarette smoking on gastrointestinal physiology and non-neoplastic digestive disease. *J Clin Gastroenterol*. 1984;6(1):65-79.
- Maity P, Biswas K, Roy S, et al. Smoking and the pathogenesis of gastroduodenal ulcer—recent mechanistic update. *Mol Cell Biochem*. 2003;253(1-2):329-338.
- Huang JQ, Sridhar S, Hunt RH. Role of *Helicobacter pylori* infection and non-steroidal anti-inflammatory drugs in peptic-ulcer disease: a meta-analysis. *Lancet*. 2002;359(9300):14-22.
- White JR, Winter JA, Robinson K. Differential inflammatory response to *Helicobacter pylori* infection: etiology and clinical outcomes. *J Inflamm Res*. 2015;8:137-147.
- Leontiadis GI, Molloy-Bland M, Moayyedi P, et al. Effect of comorbidity on mortality in patients with peptic ulcer bleeding: systematic review and meta-analysis. *Am J Gastroenterol*. 2013;108(3):331-345. quiz 46.
- Ahsberg K, Ye W, Lu Y, et al. Hospitalisation of and mortality from bleeding peptic ulcer in Sweden: a

- nationwide time-trend analysis. *Aliment Pharmacol Ther.* 2011;33(5):578-584.
29. Zucca E, Bertoni F, Roggero E, et al. Molecular analysis of the progression from *Helicobacter pylori*-associated chronic gastritis to mucosa-associated lymphoid-tissue lymphoma of the stomach. *N Engl J Med.* 1998;338(12):804-810.
 30. Schistosomes, liver flukes and *Helicobacter pylori*. IARC Working Group on the Evaluation of Carcinogenic Risks to Humans. Lyon, 7-14 June 1994. *IARC Monogr Eval Carcinog Risks Hum.* 1994;61:1-241.
 31. Take S, Mizuno M, Ishiki K, et al. Baseline gastric mucosal atrophy is a risk factor associated with the development of gastric cancer after *Helicobacter pylori* eradication therapy in patients with peptic ulcer diseases. *J Gastroenterol.* 2007;42(suppl 17):21-27.
 32. Zhou L, Lin S, Ding S, et al. Relationship of *Helicobacter pylori* eradication with gastric cancer and gastric mucosal histological changes: a 10-year follow-up study. *Chin Med J.* 2014;127(8):1454-1458.
 33. Ozturk E, Yesilova Z, Ilgan S, et al. A new, practical, low-dose 14C-urea breath test for the diagnosis of *Helicobacter pylori* infection: clinical validation and comparison with the standard method. *Eur J Nucl Med Mol Imaging.* 2003;30(11):1457-1462.
 34. Ferri F. Peptic ulcer disease. In: Ferri F, ed. *Ferri's Clinical Advisor 2016.* Philadelphia: Elsevier; 2016:943-944.
 35. Forbes GM, Glaser ME, Cullen DJ, et al. Duodenal ulcer treated with *Helicobacter pylori* eradication: seven-year follow-up. *Lancet.* 1994;343(8892):258-260.
 36. Borody TJ, George LL, Brandl S, et al. Smoking does not contribute to duodenal ulcer relapse after *Helicobacter pylori* eradication. *Am J Gastroenterol.* 1992;87(10):1390-1393.
 37. Milani M, Sharifi Y, Rahmati-Yamchi M, et al. Immunology and vaccines and nanovaccines for *Helicobacter pylori* infection. *Expert Rev Vaccines.* 2015;14(6):833-840.
 38. Chan FK, Wong VW, Suen BY, et al. Combination of a cyclo-oxygenase-2 inhibitor and a proton-pump inhibitor for prevention of recurrent ulcer bleeding in patients at very high risk: a double-blind, randomised trial. *Lancet.* 2007;369(9573):1621-1626.
 39. Ehsanullah RS, Page MC, Tildesley G, et al. Prevention of gastroduodenal damage induced by non-steroidal anti-inflammatory drugs: controlled trial of ranitidine. *BMJ.* 1988;297(6655):1017-1021.
 40. Shames B, Krajden S, Fuksa M, et al. Evidence for the occurrence of the same strain of *Campylobacter pylori* in the stomach and dental plaque. *J Clin Microbiol.* 1989;27(12):2849-2850.
 41. Nguyen AM, el Zaatari FA, Graham DY. *Helicobacter pylori* in the oral cavity. A critical review of the literature. *Oral Surg Oral Med Oral Pathol Oral Radiol Endod.* 1995;79(6):705-709.
 42. Gius JA, Boyle DE, Castle DD, et al. Vascular formations of the lip and peptic ulcer. *JAMA.* 1963;183:725-729.
 43. Colombel JF, Vernier-Massouille G, Cortot A, et al. Salomez JL. [Epidemiology and risk factors of inflammatory bowel diseases]. *Bull Acad Natl Med.* 2007;191(6):1105-1118. discussion 18-23.
 44. Jacobsen BA, Fallingborg J, Rasmussen HH, et al. Increase in incidence and prevalence of inflammatory bowel disease in northern Denmark: a population-based study, 1978-2002. *Eur J Gastroenterol Hepatol.* 2006;18(6):601-606.
 45. Wilson J, Hair C, Knight R, et al. High incidence of inflammatory bowel disease in Australia: a prospective population-based Australian incidence study. *Inflamm Bowel Dis.* 2010;16(9):1550-1556.
 46. Centers for Disease Control and Prevention. Inflammatory bowel disease (IBD): Epidemiology of the IBD. Available at: <http://www.cdc.gov/ibd/ibd-epidemiology.htm>. Accessed 25 February 2016.
 47. Benchimol EI, Fortinsky KJ, Gozdyra P, et al. Epidemiology of pediatric inflammatory bowel disease: a systematic review of international trends. *Inflamm Bowel Dis.* 2011;17(1):423-439.
 48. Lichtenstein G. Inflammatory bowel disease. In: Goldman L, Schafer A, eds. *Goldman-Cecil Medicine.* Philadelphia: Saunders/Elsevier; 2016:935-943.
 49. Rigas A, Rigas B, Glassman M, et al. Breast-feeding and maternal smoking in the etiology of Crohn's disease and ulcerative colitis in childhood. *Ann Epidemiol.* 1993;3(4):387-392.
 50. Schirbel A, Fiocchi C. Inflammatory bowel disease: established and evolving considerations on its etiopathogenesis and therapy. *J Dig Dis.* 2010;11:266-276.
 51. Molodecky N, Kaplan G. Environmental risk factors for inflammatory bowel disease. *Gastroenterol Hepatol.* 2010;6(5):339-346.
 52. Lukas M. Inflammatory bowel disease as a risk factor for colorectal cancer. *Dig Dis.* 2010;28:619-624.
 53. Batra A, Zeitl M, Siegmund B. Adipokine signaling in inflammatory bowel disease. *Inflamm Bowel Dis.* 2009;15:1897-1905.
 54. Rogler G, Andus T. Cytokines in inflammatory bowel disease. *World J Surg.* 1998;22:382-389.
 55. Katz JA. Management of inflammatory bowel disease in adults. *J Dig Dis.* 2007;8:65-71.
 56. Ruggiero C, Lattanzio F, Lauretani F, et al. Omega-3 polyunsaturated fatty acids and immune-mediated diseases: inflammatory bowel disease and rheumatoid arthritis. *Curr Pharm Des.* 2009;15:4135-4148.
 57. Kornbluth A, Sachar DB, Practice Parameters Committee of the American College of G. Ulcerative colitis practice guidelines in adults: American College of Gastroenterology, Practice Parameters Committee. *Am J Gastroenterol.* 2010;105(3):501-523. quiz 24.
 58. Annaloro C, Onida F, Lambertenghi Delilieri G. Autologous hematopoietic stem cell transplantation in autoimmune diseases. *Expert Rev Hematol.* 2009;2(6):699-715.
 59. Kashyap A, Forman SJ. Autologous bone marrow transplantation for non-Hodgkin's lymphoma resulting in long-term remission of coincidental Crohn's disease. *Br J Haematol.* 1998;103(3):651-652.
 60. Danese S. New therapies for inflammatory bowel disease: from the bench to the bedside. *Gut.* 2012;61(6):918-932.
 61. Colombel JF, Sandborn WJ, Reinisch W, et al. Infliximab, azathioprine, or combination therapy for Crohn's disease. *N Engl J Med.* 2010;362(15):1383-1395.

62. Kristo I, Stift A, Bergmann M, et al. Surgical recurrence in Crohn's disease: are we getting better? *World J Gastroenterol*. 2015;21(20):6097-6100.
63. Femiano F, Lanza A, Buonaiuto C, et al. Pyostomatitis vegetans: a review of the literature. *Med Oral Patol Oral Cir Bucal*. 2009;14(3):E114-E117.
64. Lourenco SV, Hussein TP, Bologna SB, et al. Oral manifestations of inflammatory bowel disease: a review based on the observation of six cases. *J Eur Acad Dermatol Venereol*. 2010;24(2):204-207.
65. Surawicz CM. Antibiotic-associated diarrhea and pseudomembranous colitis: are they less common with poorly absorbed antimicrobials? *Chemotherapy*. 2005;51(suppl 1):81-89.
66. Gerding DN, Johnson S. Clostridial infections. In: Goldman L, Schafer AI, eds. *Goldman-Cecil Medicine*. Philadelphia: Saunders/Elsevier; 2016:1924-1931.
67. McFarland LV. Renewed interest in a difficult disease: clostridium difficile infections—epidemiology and current treatment strategies. *Curr Opin Gastroenterol*. 2009;25(1):24-35.
68. Vassallo A, Tran MC, Goldstein EJ. *Clostridium difficile*: improving the prevention paradigm in healthcare settings. *Expert Rev Anti Infect Ther*. 2014;12(9):1087-1102.
69. Salkind AR. *Clostridium difficile*: an update for the primary care clinician. *South Med J*. 2010;103(9):896-902.
70. Kociulek LK, Gerding DN. Breakthroughs in the treatment and prevention of *Clostridium difficile* infection. *Nat Rev Gastroenterol Hepatol*. 2016.
71. Cohen SH, Gerding DN, Johnson S, et al. Clinical practice guidelines for *Clostridium difficile* infection in adults: 2010 update by the society for healthcare epidemiology of America (SHEA) and the infectious diseases society of America (IDSA). *Infect Control Hosp Epidemiol*. 2010;31(5):431-455.
72. Thornhill MH, Dayer JM, Prendergast B, et al. Incidence and nature of adverse reactions to antibiotics used as endocarditis prophylaxis. *J Antimicrob Chemother*. 2015;70:2382-2388.

PART V

Genitourinary Disease

Chronic Kidney Disease and Dialysis

Kidney disease can be caused by acute (i.e., bacterial infection, obstruction in the urinary tract, or damage to the renal parenchyma) or chronic conditions. Chronic kidney disease (CKD) is emphasized in this chapter because patients with CKD are more likely to present for dental care than those with acute disease.

Chronic kidney disease is a worldwide problem that continues to increase in prevalence.¹⁻³ CKD is associated with many serious medical problems; thus, dentists need to recognize the clinical status of these patients and must be cognizant of the possible adverse outcomes, as well as the principles of proper management. Progressive kidney disease can result in reduced renal function and ultimate kidney failure with effects on multiple organ systems. Potential manifestations include anemia, abnormal bleeding, electrolyte and fluid imbalance, hypertension, drug intolerance, and skeletal abnormalities that can affect the delivery of dental care. In addition, patients who have severe and progressive disease may require artificial filtration of the blood through dialysis or kidney transplantation (see [Chapter 21](#)). This chapter reviews the current knowledge on CKD and presents principles for dental management.

The kidneys have several important functions: They regulate fluid volume, filter waste and toxins, maintain acid–base balance of plasma; synthesize and release hormones (erythropoietin, 1,25-dihydroxycholecalciferol, and renin); are responsible for drug metabolism; and serve as the target organ for parathormone and aldosterone. Under normal physiologic conditions, 25% of the circulating blood perfuses the kidney each minute. The blood is filtered through a complex series of tubules and glomerular capillaries within the *nephron*, the functional unit of the kidney ([Fig. 12.1](#)). Ultrafiltrate, the precursor of urine, is produced in nephrons at a rate of about 125 mL/min/1.73 m².

DEFINITION

Chronic kidney disease is defined as abnormalities of kidney structure or function, present for 3 months or longer, with implications for health.^{4,5} It results from direct damage to nephrons or from progressive, chronic bilateral deterioration of nephrons. In CKD, the kidney damage is rarely repaired; thus, progressive disease (i.e., uremia and kidney failure) can lead to death. The rate of

destruction and severity of disease depend on the underlying causative disorders and contributing factors, with diabetes and hypertension recognized as the primary etiologies.^{2,6}

The National Kidney Foundation defines a five-stage classification system for CKD ([Table 12.1](#)) based on the glomerular filtration rate (GFR).^{7,8} *Stage 1* is characterized by normal or only slightly increased GFR associated with some degree of kidney damage. This stage usually is asymptomatic, with a slight (10%–20%) decline in renal function. *Stage 2* is marked by a mildly decreased GFR. *Stage 3* is evidenced as a moderately decreased GFR (30–59 mL/min), with loss of 50% or more of normal renal function. Upon arriving at stage 3, persons are at higher risk for progressive CKD. *Stage 4* is defined by a severely decreased GFR (15–29 mL/min). *Stage 5* is reflected by *renal failure*, wherein 75% or more of the approximately 2 million nephrons have lost function (GFR <15 mL/min). With disease progression (stages 2–5), nitrogen products accumulate in the blood, and the kidneys perform fewer excretory, endocrine, and metabolic functions, with eventual loss of the ability to maintain normal homeostasis. The resultant clinical syndrome—caused by renal failure, retention of excretory products, and interference with endocrine and metabolic functions—is called *uremia*.

EPIDEMIOLOGY

More than 23 million people (an estimated 11% of the adult population) in the United States have some form of kidney disease.² The early stages of CKD (stages 1–3) tend to be asymptomatic and constitute 96.5% of the disease.⁹ However, more than 871,000 people have end-stage renal disease (ESRD), and each year, more than 100,000 new cases of kidney failure are diagnosed.²

The prevalence of CKD is increasing by approximately 4% per year, most rapidly in patients older than 65 years of age and in those who have diabetes and hypertension. CKD occurs more commonly in men; African, Native, and Asian Americans; and those between the ages of 45 and 64 years. In fact, 24.5% of people 60 years and older have CKD, and more than 90% of patients with kidney failure are older than 18 years of age.²

Chronic kidney disease has well-known associations with cardiovascular disease, diabetes, and aging.

Laboratory findings consistent with stage 3 or higher CKD are present in 14% of persons with hypertension without diabetes, 20% of persons with diabetes, and 25% of persons older than 70 years of age.^{2,10} Approximately 90,000 Americans die annually as a result of kidney failure, most caused by cardiovascular system–related disease. The average dental practice that treats 2000 adults is likely to include 220 patients with physiologic evidence of CKD.

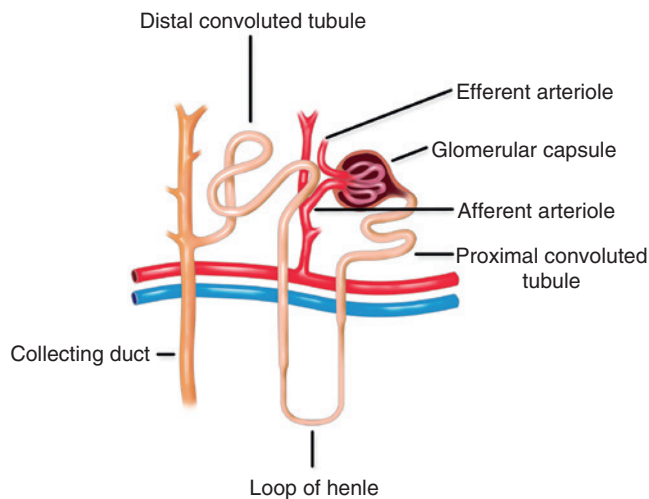

FIG 12.1 The nephron. (Courtesy of Matt Hazzard, University of Kentucky.)

ETIOLOGY

End-stage renal disease is caused by conditions that destroy nephrons. The four most common causes of ESRD are diabetes mellitus (44%), hypertension (28%), chronic glomerulonephritis (16%), and polycystic kidney disease (4.5%).⁶ Other common causes, in decreasing order, are tubular interstitial nephritis, systemic lupus erythematosus, neoplasm, obstructive nephropathies, and acquired immunodeficiency syndrome (AIDS) nephropathy.² Hereditary and environmental factors such as amyloidosis, congenital disease, hyperlipidemia, immunoglobulin A nephropathy, and silica and smoke exposure also contribute to the disease. Age older than 60 years is the highest risk factor for CKD.¹¹

PATHOPHYSIOLOGY AND COMPLICATIONS

The kidneys filter about 180 L/day through the function of approximately 2 million nephrons. Deterioration and destruction of functioning nephrons are the underlying pathologic processes of renal failure.⁶ The nephron includes the glomerulus, tubules, and vasculature. Various diseases affect different segments of the nephron at first, but the entire nephron eventually is affected. For example, whereas hypertension affects the vasculature first, glomerulonephritis affects the glomeruli first. Importantly, nephrons that are lost are not replaced. However, because of compensatory hypertrophy of the remaining nephrons, normal renal function is maintained for a time. During

TABLE 12.1 Classification of Stages of Chronic Kidney Disease (CKD) and Associated Comorbid Conditions

CKD Stage	Description	GFR (mL/min/1.73 m ²)	Frequency of Comorbid Conditions
1	Chronic kidney damage; normal or ↑ GFR	≥90	Anemia: 4% HTN: 40% DM: 9%
2	Mild ↓ GFR	60–89	Anemia: 4% HTN: 40% DM: 13%
3	Moderate ↓ GFR	30–59	Anemia: 7%
3a		45–59	HTN: 55%
3b		30–44	DM: 20% HPT: >50% 5-yr mortality rate: 24%
4	Severe ↓ GFR	15–29	Anemia 29% HTN 77% DM 30% HPT >50% 5-yr mortality rate: 46%
5	Kidney failure—ESRD	<15 (or dialysis)	Anemia 69% HTN 75% DM 40% HPT >50% 5-yr mortality rate: >50%

DM, Diabetes mellitus; ESRD, end-stage renal disease; GFR, glomerular filtration rate; HPT, hyperparathyroidism; HTN, hypertension.

Data from Mitch WE: Chronic kidney disease. In Goldman L, Ausiello D, editors: *Goldman-Cecil medicine*, ed 25, Philadelphia, 2016, Saunders, pp 833-41.

this period of relative renal insufficiency, homeostasis is preserved. The patient remains asymptomatic and demonstrates minimal laboratory abnormalities such as a diminished GFR. Normal function is maintained until greater than 50% of nephrons are destroyed. Subsequently, compensatory mechanisms are overwhelmed, and the signs and symptoms of uremia appear. In terms of morphology, the end-stage kidney is markedly reduced in size, scarred, and nodular (Fig. 12.2).

A patient in early renal failure may remain asymptomatic, but physiologic changes invariably develop as the disease progresses. Such changes result from the loss of nephrons. Renal tubular malfunction causes the sodium pump to lose its effectiveness, and sodium excretion occurs. Along with sodium, excessive amounts of dilute urine are excreted, which accounts for the polyuria that is commonly encountered.⁶

Patients with advanced renal disease develop *uremia*, which is uniformly fatal if not treated. Failing kidneys are unable to concentrate and filter the intake of sodium, which contributes to the drop in urine output, development of fluid overload, hypertension, insulin resistance, risk for severe electrolyte disturbances (sodium depletion and hyperkalemia—higher-than-normal levels of potassium),

and cardiac disease. These cardiovascular system–related events cause approximately half of the deaths occurring annually among patients with ESRD.^{6,12}

The buildup of nonprotein nitrogen compounds in the blood, mainly urea, as a consequence of loss of glomerular filtration function, is called *azotemia*. Level of azotemia is measured as blood urea nitrogen (BUN). Acids also accumulate because of tubular impairment. The buildup of waste products serves as a substrate for the development of metabolic acidosis, the major result of which is ammonia retention. In the later stages of renal failure, acidosis causes nausea, anorexia, and fatigue. Patients may hyperventilate to compensate for the metabolic acidosis. With acidosis superimposed on ESRD, adaptive mechanisms already are taxed beyond normal levels, and any increase in demand can lead to serious consequences. For example, sepsis or a febrile illness can result in profound acidosis and may be fatal.⁶

Patients with ESRD demonstrate several hematologic abnormalities, including anemia, leukocyte and platelet dysfunction, and coagulopathy. Anemia, caused by iron deficiency, decreased erythropoietin production by the kidney, inhibition of red blood cell (RBC) production, hemolysis, bleeding episodes, and shortened RBC survival, is one of the most common manifestations of ESRD. Most of these effects result from unidentified toxic substances in uremic plasma and from other factors.^{6,13} Host defense is compromised by nutritional deficiencies, leukocyte dysfunction, depressed cellular immunity, and hypogammaglobulinemia. This diminished capacity leads to diminished granulocyte chemotaxis, phagocytosis, and bactericidal activity, making affected persons more susceptible to infection.¹⁰

Hemorrhagic diatheses, characterized by tendency toward abnormal bleeding and bruising, are common in patients with ESRD and are attributed primarily to abnormal platelet aggregation and adhesiveness, decreased platelet factor 3, impaired prothrombin consumption, and loss of clotting factors with proteinuria. Defective platelet production also may play a role. Platelet factor 3 enhances the conversion of prothrombin to thrombin by activated factor X.¹⁰

The cardiovascular system is affected by hyperlipidemia, athero- and arteriosclerosis, and arterial hypertension—the latter caused by sodium chloride (NaCl) retention, fluid overload, and inappropriately high renin levels. Congestive heart failure and hypertrophy of the left ventricle, which may compromise coronary artery blood flow, are relatively common developments. These complications, along with electrolyte disturbances, put patients with ESRD at increased risk for sudden death from myocardial infarction.¹⁴

A variety of bone disorders are seen in ESRD; these are collectively referred to as *renal osteodystrophy*. Decreased kidney function results in decreased 1- α -hydroxylation of vitamin D, which leads to reduced intestinal absorption of calcium (thereby contributing to

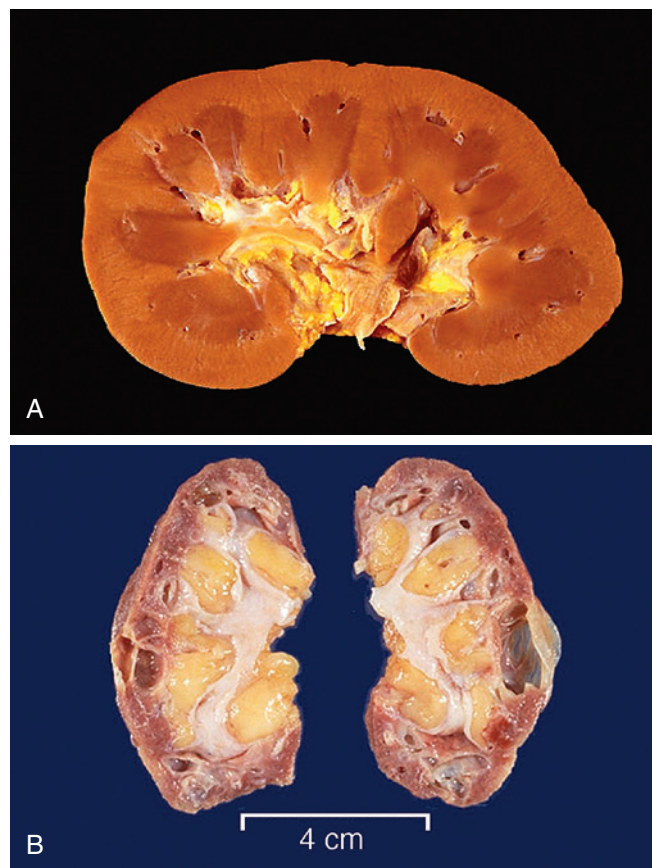

FIG 12.2 Gross renal anatomy. **A**, A normal kidney. **B**, Atrophic kidneys from a patient with chronic glomerulonephritis. (From Klatt EC: *Robbins and Cotran atlas of pathology*, ed 2, Philadelphia, 2010, Saunders.)

hypocalcemia). With advanced CKD and the loss of nephrons, renal phosphate excretion drops, and the bone attempts to buffer the acid buildup by releasing calcium and phosphates. This leads to demineralization, weak bones, and calcium–phosphate complexes in blood. The resulting low levels of serum ionized calcium stimulate the parathyroid glands to secrete parathyroid hormone (PTH), which results in *secondary hyperparathyroidism*.⁶ PTH has three main functions:

- Inhibiting the tubular reabsorption of phosphorus
- Stimulating renal production of the vitamin D necessary for calcium metabolism
- Enhancing vitamin D absorption within the intestine

High levels of PTH are sustained, however, because in ESRD, the failing kidney does not synthesize 1,25-dihydroxycholecalciferol, the active metabolite of vitamin D; thus, calcium absorption in the gut is inhibited. PTH activates tumor necrosis factor and interleukin-1, which mediate bone remodeling, calcium mobilization from bones, and increased excretion of phosphorus, potentially leading to formation of renal and metastatic calcifications. Levels of fibroblast growth factor 23 (FGF-23), a key regulator of phosphorus and vitamin D metabolism, also increase and result in inhibition of osteoblast maturation and matrix mineralization.¹² The progression of osseous changes is as follows: *osteomalacia* (increased unmineralized *osteoid* bone matrix) followed by *osteitis fibrosa* (bone resorption with lytic lesions and marrow fibrosis) (Fig. 12.3) and, finally, *osteosclerosis*



FIG 12.3 Lytic lesion in the anterior mandible of a patient with hyperparathyroidism. (Courtesy of L.R. Bean, Lexington, KY.)

of variable degree (enhanced bone density) (Fig. 12.4). With renal osteodystrophy in children, bone growth is impaired, along with a tendency for spontaneous fractures with slow healing, myopathy, aseptic necrosis of the hip, and extraosseous calcifications.

CLINICAL PRESENTATION

Clinical features of renal failure are illustrated in Fig. 12.5. Although the type and extent of manifestations vary with severity and the particular patient, they must be recognized in the context of the patient's overall physical status. Also, the effects of renal failure are often widespread and can involve multiple systems (e.g., >40% of patients with ESRD also have diabetes, and >25% have concurrent hypertension).²

Signs and Symptoms

Patients with CKD may show few clinical signs or symptoms until the condition progresses to stage 3. At this stage and beyond, patients may complain of a general ill feeling, fatigue, weakness, headaches, nausea, loss of appetite, and weight loss. With further progression, anemia; leg cramps; insomnia; dark urine; and an increased need to urinate, especially at night (nocturia), often develop. The anemia produces pallor of the skin and mucous membranes and contributes to the symptoms of lethargy and dizziness.

Patients with renal failure are more likely to experience bone pain (e.g., pain in the lower back, hips, knees) and

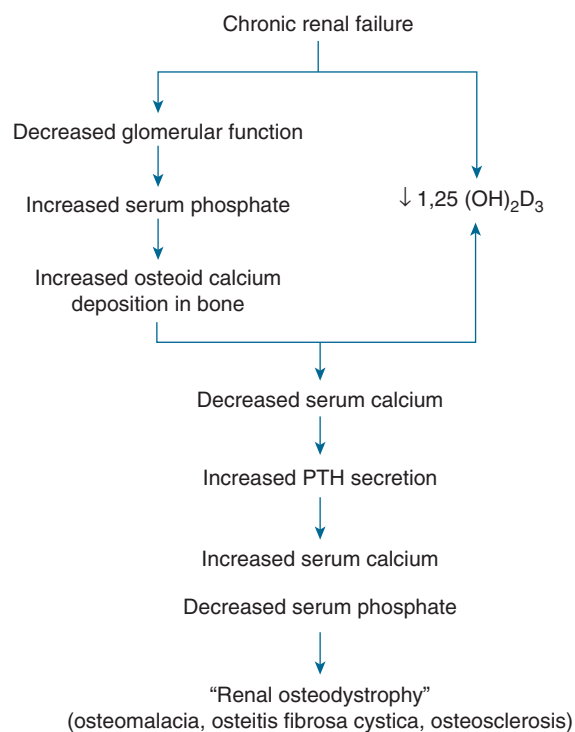

FIG 12.4 Summary of changes that result in renal osteodystrophy. PTH, Parathyroid hormone.

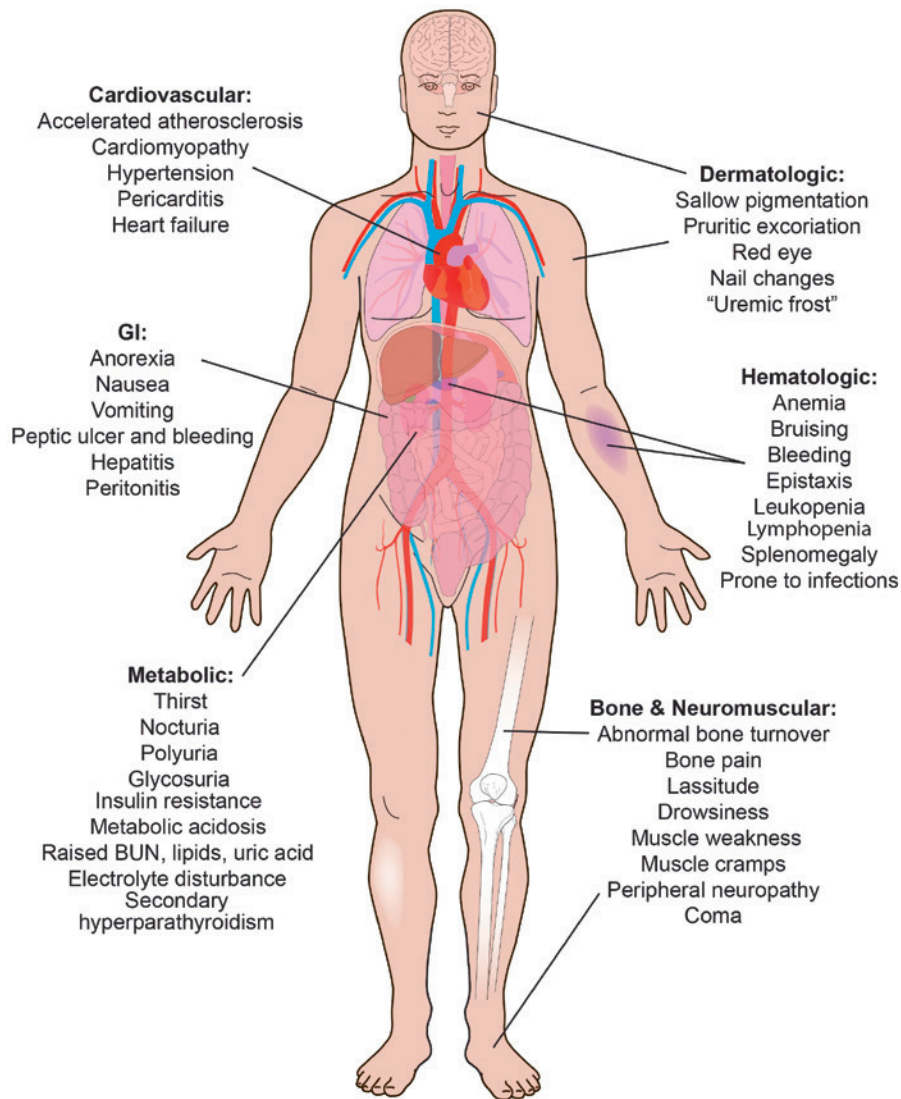

FIG 12.5 Clinical features of chronic renal failure. (Courtesy Matt Hazzard, University of Kentucky.)

develop GI signs and symptoms such as anorexia, nausea, and vomiting, generalized gastroenteritis, and peptic ulcer disease. Uremic syndrome commonly causes malnutrition and diarrhea. Patients demonstrate mental slowness or depression and become psychotic in later stages. They also may exhibit signs of peripheral neuropathy and muscular hyperactivity (twitching, restless legs). Convulsions may be a late manifestation that directly correlates with the degree of azotemia. Additional findings may include stomatitis manifested by oral ulceration and candidiasis (Fig. 12.6), parotitis, or smell and taste disturbances. A urine-like odor to the breath may be detected.^{10,15}

Because of the bleeding diatheses that accompany ESRD, hemorrhagic episodes are common, particularly occult GI bleeding. In patients who receive dialysis, however, benefits include improved control of uremia and less severe bleeding. Skin manifestations associated with bleeding



FIG 12.6 Oral candidiasis in a patient with end-stage renal disease.

diatheses include ecchymoses, petechiae, purpura, and gingival or mucous membrane bleeding (e.g., epistaxis). In addition, hyperpigmentation of the skin occurs with ESRD, which is characterized by a brownish-yellow appearance caused by the retention of carotene-like pigments normally excreted by the kidney. These pigments may cause profound pruritus. An occasional finding is a whitish coating on the skin of the trunk and arms produced by residual urea crystals left when perspiration evaporates (“uremic frost”).⁶

Cardiovascular manifestations of ESRD include hypertension, congestive heart failure (shortness of breath, orthopnea, dyspnea on exertion, peripheral edema), and pericarditis.^{6,10}

LABORATORY AND DIAGNOSTIC FINDINGS

The diagnosis of kidney disease is based on history; physical evidence; laboratory evaluation; and, in select disorders, imaging and biopsy. Evaluation includes measures of blood pressure, GFR, urinalysis, serum BUN, serum creatinine, creatinine clearance, and electrolytes.

The most basic test of kidney function is urinalysis, which is the physical, chemical, and microscopic examination of urine. Urinalysis typically looks for proteinuria, hematuria, cellular casts, specific gravity, pH, and a range of chemicals.

The GFR is the best measure of overall kidney function, and the most significant protein in the urine is albumin (albuminuria). Together these two measures are used to determine the severity and prognosis of CKD.⁵ Fig. 12.7

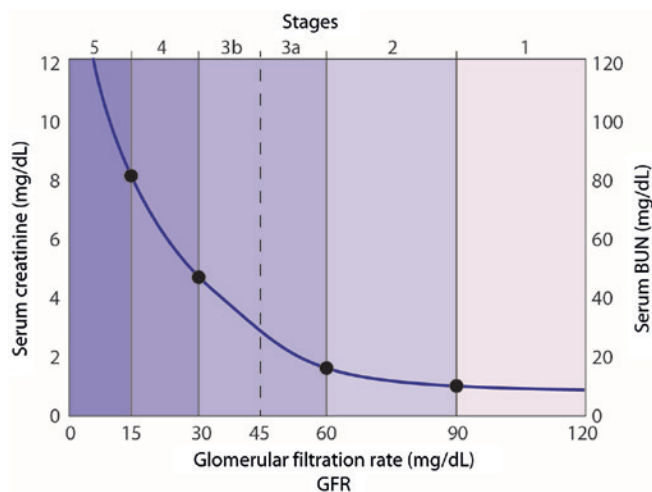

FIG 12.7 Relationship of renal function to serum enzymes and glomerular filtration rate (GFR). Of note, patients often remain asymptomatic as renal failure develops until the GFR drops below 20 mL/min, albuminuria exceeds 300 mg/g, the creatinine clearance drops below 20 mL/min, and the blood urea nitrogen (BUN) is above 20 mg/dL. In fact, uremic syndrome is rare before the BUN concentration exceeds 60 mg/dL. (Courtesy of Matt Hazzard, University of Kentucky.)

and Table 12.2 illustrate additional laboratory test results that help to measure kidney function.

Serum creatinine level is a measure of muscle breakdown and filtration capacity of the nephron. The creatinine concentration is proportional to the glomerular filtration and can be measured in serum as well as urine. The creatinine clearance compares the creatinine concentrations in blood and urine (in a 24-hour urine collection). BUN is a commonly used indicator of kidney function; however, it is not as specific as creatinine clearance or serum creatinine level because BUN is also influenced by liver function and conditions that affect blood flow.⁶ Other tests used to assess and monitor kidney disease include determinations of serum electrolytes involved in acid–base regulation and calcium and phosphorus metabolism (see Table 12.2), complete blood count, PTH levels, bone density measures, and urine immunoelectrophoresis.⁶

MEDICAL MANAGEMENT

Conservative Care

Clinical practice guidelines for the management of CKD have been addressed by national and international experts.^{5,7,8} The goals of treatment are to retard the progress of disease and to preserve the patient’s quality of life. A conservative approach, which may be adequate for prolonged periods, is recommended for stage 1 and stage 2 CKD. Conservative care involves decreasing the retention of nitrogenous waste products and controlling hypertension, fluids, and electrolyte imbalances. These improvements are accomplished by dietary modifications, including instituting a low-protein diet and limiting fluid, sodium, and potassium intake. Comorbid conditions such as diabetes, hypertension, congestive heart failure, and hyperparathyroidism are corrected or controlled during the earliest stage possible. Anemia, malnutrition, and bone disease (e.g., hyperparathyroidism) typically are managed beginning in stage 3. By stage 4, care by a nephrologist is recommended, and preparations for renal replacement therapy begin. In stage 5, or when uremic features appear or intractable fluid overload occurs, dialysis is started. Renoprotective strategies for slowing progression of CKD and addressing comorbid conditions are summarized in Table 12.3.^{9,16-18}

Dialysis

Dialysis is a medical procedure that artificially filters blood. Dialysis becomes necessary when the number of nephrons diminishes to the point that azotemia is unpreventable or uncontrollable. The initiation of dialysis is an individual patient decision that becomes important when the GFR drops below 30 mL/minute/1.73 m². More than 400,000 people receive dialysis in the United States, at a cost of more than \$7 billion a year. The procedure can be accomplished by peritoneal dialysis or hemodialysis.^{4,16,19}

TABLE 12.2 Laboratory Values for the Assessment of Renal Function and Failure

Laboratory Test	Reference Value	Indicator* of Renal Insufficiency (Stages II–IV)	Indicator of Renal Failure (Stage V)
URINE			
Albuminuria	<30 mg/g	30–300 mg/g	>300 mg/g
Creatinine clearance (CCr)	85–125 mL/min (women) 97–140 mL/min ³⁴	50–90 mL/min	Moderate: 10–50 mL/min; severe: <10 mL/min
Glomerular filtration rate (GFR) [†]	100–150 mL/min	15–89 mL/min	Moderate: <15 mL/min; severe: <10 mL/min
SERUM			
Blood urea nitrogen (BUN)	8–18 mg/dL (3–6.5 mmol/L)	20–30 mg/dL	Moderate: 30–50 mg/dL; severe: >50 mg/dL
Creatinine	0.6–1.20 mg/dL	2–3 mg/dL	Moderate: 3–6 mg/dL; severe: >6 mg/dL

*Secondary indicators of renal function. Normal reference values: calcium, 8.2–11.2 mg/dL; chloride, 95–103 mmol/L; inorganic phosphorus, 2.7–4.5 mg/dL; potassium, 3.8–5 mmol/L; sodium, 136–142 mmol/L; total carbon dioxide for venous blood, 22–26 mmol/L; and uric acid, 2.4–7.0 mg/dL.

[†]GFR is often calculated using the Cockcroft-Gault equation, the Modification of Diet in Renal Disease (MDRD) Study equation, or the Chronic Kidney Disease Epidemiology Collaboration (CKD-EPI) equation.

Adapted from National Kidney Foundation: K/DOQI clinical practice guidelines for chronic kidney disease: evaluation, classification, and stratification, *Am J Kidney Dis* 39:S1–S266, 2002 and Evaluation and management of chronic kidney disease: synopsis of the kidney disease: improving global outcomes 2012 clinical practice guideline, *Ann Intern Med* 158:825–30, 2013.

TABLE 12.3 Renoprotective Strategies for Slowing Progression* of Chronic Kidney Disease and Addressing Comorbid Conditions

Parameter	Goal	Intervention
Lifestyle modifications	Smoking cessation, achieving ideal body weight, exercising for 30 min 5× week	Counseling, exercise program, medical appointments every 3–6 months
Lipid lowering	LDL <100 mg/dL	Dietary counseling, statins
Blood pressure control (mm Hg)	<130/80 mm Hg for proteinuria with excretion <1 g protein/day; <125/75 mm Hg for proteinuria with excretion >1 g/day	ACE inhibitors, ARBs, sodium, restriction, diuretics, beta-blockers
Dietary protein and potassium restriction	<2 g/day and 40–70 mEq/day, respectively	Dietary counseling
Reduction in proteinuria	<0.5 g/day	ACE inhibitors, ARBs
Glycemic control	HgbA _{1c} <7%	Dietary counseling, oral hypoglycemic agents, insulin
Anemia management	Hemoglobin 10–12 g/dL	Injections of ferumoxytol IV (Feraheme) or recombinant human erythropoietin (epoetin alfa or darbepoetin alfa)
Control of PTH levels to prevent secondary hyperparathyroidism	PTH: stage 3, 35–70 pg/mL; stage 4, 70–110 pg/mL; stage 5, 150–300 pg/mL	Low-phosphate diet + use of nonaluminum phosphate binders (e.g., calcium carbonate) + vitamin D analogue

*One third of stage 4 CKD patients will progress to ESRD within 3 years.

ACE, Angiotensin-converting enzyme; ARB, angiotensin receptor blocker; HgbA_{1c}, hemoglobin A1c; IV, intravenous; LDL, low-density lipoprotein; PTH, parathyroid hormone. Adapted from Carey WD, editor: *Cleveland Clinic: current clinical medicine*, ed 2, St. Louis, 2010, Saunders and Abboud H, Henrich WL: Clinical practice. Stage IV chronic kidney disease, *N Engl J Med* 362:56–65, 2010.

Peritoneal dialysis is performed on about 36,000 Americans.²⁰ It may be provided as continuous cyclic peritoneal dialysis (CCPD) or chronic ambulatory peritoneal dialysis (CAPD). With both modalities, a hypertonic solution is instilled into the peritoneal cavity through a permanent peritoneal catheter. After a time, the solution and dissolved solutes (e.g., urea) are drawn out. The older method, CCPD, also known as automated peritoneal

dialysis (APD), uses a machine to perform three to five dialysate exchanges while the patient sleeps (for 8–10 hours). During the day, excretory fluids accumulate in the patient's abdomen until dialysis is repeated that evening.²¹

Chronic ambulatory peritoneal dialysis is a more commonly used procedure. Dialysis performed using this method (Fig. 12.8) requires shorter exchange periods of



FIG 12.8 Chronic ambulatory peritoneal dialysis catheter site in the abdominal wall. (From Lewis SM, Dirksen SR, Heitkemper MM, et al, editors: *Medical surgical nursing*, ed 8, St. Louis, 2011, Mosby. Courtesy of Mary Jo Holechek, Baltimore, MD.)

30 to 45 minutes four to five times per day. Exchanges are performed manually, with instillation of 1.5 to 3 L of dialysate into the peritoneal cavity. The catheter is sealed, and every 3 to 6 hours, the dialysate is allowed to drain into a bag strapped to the patient, and new dialysate is instilled by gravity. CAPD allows the patient more freedom than CCPD. However, both methods allow patients to perform routine functions between exchanges (e.g., walking, working).¹⁶

The advantages of peritoneal dialysis are its relatively low initial cost, ease of performance, reduced likelihood of infectious disease transmission, and absence of requirement for anticoagulation. Disadvantages include the need for frequent sessions, risk of peritonitis (≈ 1 case per patient every 1.5 years), frequent association with abdominal hernia, and significantly lower effectiveness than that for hemodialysis. Its principal use is in patients in acute renal failure or those who require only occasional dialysis.

In the United States, most dialysis patients (88%) receive hemodialysis.^{2,22,23} Hemodialysis is the method of choice when azotemia occurs and dialysis is needed on a long-term basis. Treatments are performed every 2 or 3 days, depending on need. Usually 3 to 4 hours is required for each session (Fig. 12.9). Hemodialysis consumes an enormous amount of the patient's time and is extremely confining. However, between dialysis sessions, patients lead relatively normal lives.²³

More than 80% of the people who receive hemodialysis in the United States do so through a permanent and surgically created arteriovenous graft or fistula, usually placed in the forearm. Access is achieved by cannulation of the fistula with a large-gauge needle (Fig. 12.10). Approximately 18% of patients receive dialysis through a temporary or permanent central catheter while the permanent access site is healing or when all other access options have been exhausted. Patients are "plugged in" to the hemodialysis machine at the fistula or graft site,



FIG 12.9 Patient undergoing hemodialysis. (From Ignatavicius D, Workman ML: *Medical-surgical nursing: patient-centered collaborative care*, ed 6, St. Louis, 2010, Saunders.)



FIG 12.10 Site of a surgically created arteriovenous fistula, with subsequent dilation and hypertrophy of the veins. (From Kumar P, Clark ML: *Kumar and Clark's clinical medicine*, ed 7, Edinburgh, 2009, Saunders.)

and blood is passed through the machine, filtered, and returned to the patient. Heparin usually is administered during the procedure to prevent clotting.²²

Although hemodialysis is a lifesaving technique, dialysis provides only about 15% of normal renal function, and complications develop as a result of the procedure. Serum

calcium concentrations require close regulation that is achieved using calcium supplements, active forms of vitamin D (i.e., calcitriol, alfacalcidol, paricalcitol, or doxercalciferol), or dialysate that contains calcium.¹⁸ Improper blood levels contribute to muscle tetany and oversecretion of PTH. Dialysis-related amyloidosis is common in persons on dialysis for more than 5 years as a consequence of deposition of proteins present in the blood on joints and tendons, causing pain and stiffness. Anemia is a common feature of renal failure and dialysis and is treated with recombinant human erythropoietin. The risk of hepatitis B, hepatitis C, and human immunodeficiency virus (HIV)²⁴ infections is increased because dialyzers usually are disinfected—not sterilized—between uses, and patients usually have multiple blood exposures. A 2002 national survey reported that among patients maintained on hemodialysis, the prevalence of hepatitis B surface antigen positivity (carriers of hepatitis B) was 1.0%; of hepatitis C seropositive status, 7.8%; and of HIV seropositivity, 1.5%. Although all three viruses constitute a reservoir of potential infection, only hepatitis B virus and hepatitis C virus have been reported to be transmitted nosocomially in dialysis centers in the United States.^{23,25}

Infection of the arteriovenous fistula is a possibility and can result in septicemia, septic emboli, infective endarteritis, and infective endocarditis. *Staphylococcus aureus* is the most common cause of vascular access infection and related bacteremia in these patients. The risk of fistula infection from surgical procedures (e.g., urogenital, oral surgical, dental) is considered to be low. A related concern is risk for infection and antibiotic-resistant infection. Of note, rates of tuberculosis and vancomycin- and methicillin-resistant infections are higher among patients maintained on long-term hemodialysis than in the general public.^{23,26}

As with all patients with ESRD, drugs that are metabolized primarily by the kidney or that are nephrotoxic must be avoided in patients receiving dialysis.^{27,28}

Another problem associated with dialysis is abnormal bleeding. Patients with ESRD have bleeding tendencies secondary to altered platelet aggregation and decreased platelet factor 3. Hemodialysis is associated with the additional problem of platelet destruction by mechanical trauma of the procedure. Aluminum contamination of the dialysate water may interfere with heme synthesis, contributing to the development of anemia and osteomalacia.²² Also, the process of hemodialysis may activate prostaglandin I₂ (prostacyclin), which can reduce platelet aggregation.

The 5-year survival rate of dialysis patients is 35%. An expected 7.1 years of remaining life occurs on average when dialysis is begun between age 50 and 54 years.² An alternative to long-term dialysis is renal transplantation (see Chapter 21). Transplantation provides an average of 17.2 years of expected life remaining but also is associated with a significant number of issues.

DENTAL MANAGEMENT

Patient Under Conservative Care

Medical Considerations

Identification. The National Kidney Foundation's guidelines recommend that high-risk groups (i.e., patients with diabetes and hypertension) be screened for CKD. Thus, medical referrals should be made for screening when diabetes and hypertension are present and when other known risk factors are present (e.g., patients who are obese, smoke, have cardiovascular disease, or have family members with ESRD). Likewise, any patient who has signs and symptoms of kidney disease (e.g., hematuria, repeated urinary tract infections or edema) but has not been assessed should be referred to a physician for diagnosis and treatment. This simple step in coordinating care can improve the patient's awareness of his or her health and minimize patient morbidity and mortality associated with CKD.

Risk Assessment. Risk assessment begins with knowing the patient's GFR, the stage of CKD, and the extent of albuminuria. With CKD graded stage 1 to 3, problems generally do not arise in the provision of outpatient dental care if the patient's disease is well controlled and conservative medical care is being provided. With CKD of stage 4 or higher, consultation with the patient's physician is suggested before dental care is provided. If the patient is in advanced stages of renal failure or has another comorbid condition (e.g., diabetes mellitus, hypertension, systemic lupus erythematosus) or if severe albuminuria or electrolyte imbalance is present, dental care may best be provided after physician consultation in a hospital-like setting. Deferral of treatment may be required until the status of the patient has been ascertained and the CKD is adequately controlled (Box 12.1).

Recommendations. In developing recommendations for dental patients who have kidney disease, the dentist must consider the type and degree of kidney dysfunction, the medical care being provided, and the dental procedure planned.

Antibiotics. Patients who have CKD (stages 1–3) and are not receiving dialysis generally have few issues with infection, so they generally do not require additional antibiotic considerations. However, when invasive procedures are planned for a patient with CKD above stage 3, the dentist should consult with the physician to assess the need for antibiotics. Alterations in drug dosage may be needed, depending on the amount of renal function retained. If an orofacial infection occurs, aggressive management with the use of culture and sensitivity testing and appropriate antibiotics is generally necessary.

Bleeding. Because of the potential for bleeding problems, if an invasive procedure is planned, the patient should undergo pretreatment screening for bleeding disorders, and a platelet count should be obtained (see Chapter 24). Hematocrit level and hemoglobin count also should be obtained for assessment of anemia. Any

BOX 12.1

Dental Management Considerations in Patients With End-Stage Renal Disease Under Conservative Care

P

Patient Evaluation and Risk Assessment (See Box 1.1)

- Evaluate and determine whether renal disease exists.
- Obtain medical consultation if patient's disease is poorly controlled, if signs and symptoms point to an undiagnosed condition, or if the diagnosis is uncertain.

Potential Issues and Factors of Concern

A

Analgesics	Dosage adjustment likely when GFR is <50 mL/min. Avoid long-term use of NSAIDs in CKD. Avoid narcotics in CKD because these drugs can cause prolonged sedation and respiratory depression.
Antibiotics	Dosage adjustments likely when GFR is <50 mL/min. Aggressively manage orofacial infections with culture and sensitivity testing and antibiotics. Consider hospitalization for severe infection or major procedures. A loading dose may be required when infection and CKD are concurrent.
Anesthetics (local)	Dosage adjustment generally is not required.
Antianxiety	Dosage adjustment for single-dose benzodiazepines is not necessary.

B

Bleeding	Screen for bleeding disorder before invasive procedures. Pay meticulous attention to good surgical technique. Excessive bleeding may occur in the patient with untreated or poorly controlled CKD. Use topical hemostatic agents.
Blood pressure	Monitor BP closely because hypertension is common in CKD. Refer patient for physician evaluation if BP is elevated.

C

Chair position	If patient is on antihypertensive medication, assist her or him to regain equilibrium in upright position before exiting dental chair.
----------------	--

D

Devices	No issues
Drugs (interactions, allergies, or supplementation)	Adjust dosage of drugs metabolized by the kidney when GFR is <50 mL/min, per Table 12.4. Avoid nephrotoxic drugs (aminoglycosides, acetaminophen in high doses, acyclovir, aspirin, other NSAIDs, tetracycline).

E

Emergencies	Minimize risk for emergencies by avoiding invasive procedures and long appointments if disease is unstable (poorly controlled) or advanced (CKD stage 3 or higher).
-------------	---

Receiving Hemodialysis

P

Patient Evaluation and Risk Assessment (See Box 1.1)

- Same as for conservative care recommendations
- Also determine liver function status and assess for presence of opportunistic infection in these patients because of increased risk for development of carrier state with hepatitis B and C viruses and human immunodeficiency virus.²⁰

Potential Issues and Factors of Concern

- Same as for conservative care recommendations, plus the following issues:

A

Antibiotics	Consider antimicrobial prophylaxis if abscess is present (based on guidelines; see Box 12.3).
-------------	---

D

Day of appointment	Avoid dental care on day of hemodialysis (especially within first 6 hours afterward); best to treat on day after
Devices	Avoid arm with AV shunt for blood pressure measurements and delivery of IV medications. Also see Box 12.3.
Drugs (interactions, allergies, or supplementation)	Adjust drug dosages based on Table 12.4. Consider corticosteroid supplementation if indicated (see Table 15.2).

F

Follow-up	Patients who have had CKD should be contacted to ensure that the postoperative course proceeds without complications.
-----------	---

AV, Arteriovenous; BP, blood pressure; CKD, chronic kidney disease; GFR, glomerular filtration rate; NSAID, nonsteroidal antiinflammatory drug.

abnormal values should be discussed with the physician. Few problems are encountered with nonhemorrhagic dental procedures when the hematocrit level is above 25%. If bleeding is anticipated, hematocrit levels can be raised with the use of erythropoietin under the guidance

of the physician. A less desirable option is RBC transfusion, which carries the risks of sensitization and bloodborne infection.

When surgical procedures are undertaken, meticulous attention to good surgical technique is necessary to

decrease the risks of excessive bleeding and infection. Local hemostatic agents (topical thrombin, microfibrillar collagen, absorbable gelatin sponge, suture) should be available and used during dental surgical procedures performed on patients with uremia. Desmopressin should be avoided.²⁸ Conjugated estrogens are helpful when a longer duration of action is required; however, 1 week of therapy usually is needed to guarantee efficacy. High-purity plasma-derived products such as cryoprecipitate (a plasma derivative rich in factor VIII, fibrinogen, and fibronectin) may be used in refractory cases in consultation with the patient's hematologist. Platelet transfusions are used infrequently because of the associated risk of immunogenic sensitization.

Blood Pressure. When dental treatment is provided on an outpatient basis, blood pressure should be closely monitored before and during the procedure. Patients should be informed that good control of blood pressure will benefit both kidney and overall health.

Capacity to Tolerate Care. In patients whose kidney function is deteriorating (GFR <50 mL/min), elective dental care should be delayed until consultation is obtained and the patient is medically stable. Patients who take large doses of corticosteroids (e.g., ≥ 10 mg/day of prednisone or equivalent), as often prescribed for medical management of ESRD, may develop adrenal insufficiency. To avoid an adrenal crisis in patients on such regimens, the dental clinician should ensure that the usual corticosteroid dose is taken before surgical procedures and must monitor the patient closely during the postsurgical phase of care (see Chapter 15).²⁵

Drug Considerations. A major concern in the treatment of patients with ESRD is the potential for toxic effects on the kidneys and other adverse effects associated with drugs prescribed by the health care provider.²⁸ Accordingly, dentists should know which drugs to use, which to avoid, and the correct drug dosage for the patient situation (Table 12.4). Some drugs are excreted primarily by the kidneys, and certain agents are inherently nephrotoxic. As a general rule, drugs excreted by the kidneys are eliminated twofold less efficiently when the GFR drops to 50 mL/min and thus may reach toxic levels at lower GFR. In such circumstances, the drug dosage needs to be reduced, and the timing of administration must be prolonged. Nephrotoxic drugs such as acyclovir, aminoglycosides, aspirin, nonsteroidal antiinflammatory drugs (NSAIDs), and tetracycline should generally be avoided in patients with renal impairment. NSAIDs inhibit prostaglandin synthesis, resulting in vasoconstriction and reduced renal perfusion. Acetaminophen also is nephrotoxic and may cause renal tubular necrosis at high doses, but it is probably safer than aspirin in these patients when used for a short time frame because acetaminophen is metabolized in the liver. An alternative analgesic is tramadol.²⁸ Tetracyclines, except for doxycycline, worsen renal impairment by inhibiting protein synthesis and have been associated with kidney deterioration in the dental setting.²⁹

Drug frequency and dosage adjustments are required during advanced CKD for reasons besides nephrotoxicity and renal metabolism. For example, (1) a low serum albumin value reduces the number of binding sites for circulating drugs, thereby enhancing drug effects; (2) uremia can modify hepatic metabolism of drugs (increasing or decreasing clearance)^{30,31}; (3) antacids can affect acid–base or electrolyte balance, further complicating uremic effects on electrolyte balance; (4) larger initial doses may be required in the presence of substantial edema or ascites, whereas smaller initial doses may be required if dehydration or severe debilitation is present; and (5) aspirin and other NSAIDs potentiate uremic platelet defects, so these antiplatelet agents may need to be avoided if invasive procedures are performed³² (see Table 12.4).

Although nitrous oxide and diazepam are antianxiety agents that require little modification for use in patients with ESRD, the hematocrit or hemoglobin concentration should be measured before intravenous sedation to ensure adequate oxygenation. Drugs that depress the central nervous system (barbiturates, narcotics) are best avoided in the presence of uremia because the blood–brain barrier may not be intact, so excessive sedation may result. Opioid use, if needed, requires dosage adjustment for CKD patients, and meperidine should be avoided in patients with CKD because its metabolite can accumulate, leading to seizures. When the hemoglobin concentration is below 10 g/100 mL, general anesthesia is not recommended for patients with ESRD.³³

Oral Complications and Manifestations. Box 12.2 lists some common oral manifestations of chronic renal failure.¹⁵ A red-orange discoloration of the cheeks and mucosa is associated with pruritus, and deposition of carotene-like pigments appears when renal filtration is decreased. Salivary flow may be diminished, resulting in xerostomia and parotid infections.^{34,35} Candidiasis is more frequent when salivary flow is diminished. Patients frequently complain of an altered or metallic taste, and saliva is altered in composition, has a higher pH, and

BOX 12.2 Oral Manifestations of Chronic Kidney Failure

- Pallor; pigmentation, and petechiae (also ecchymosis) of oral mucosa
- Dry mouth (xerostomia), altered taste (dysgeusia), halitosis
- Infections: candidiasis, periodontitis, parotid infections
- Enamel defects of developing dentition (hypoplasia and hypocalcification)
- Osteodystrophy (radiolucent jaw lesions)
- Uremic stomatitis*

*Noted in severe end-stage renal disease.

Data from Proctor R, Kumar N, Stein A, et al: Oral and dental aspects of chronic renal failure, *J Dent Res* 84:199-208, 2005 and Patil S, Khaandelwal S, Doni B, et al: Oral manifestations in chronic renal failure patients attending two hospitals in North Karnataka, India. *Oral Health Dent Manag* 11:100-106, 2012.

TABLE 12.4 Drug Adjustments in Chronic Renal Disease

Drug and Usual Dose	Route of Elimination or Metabolism	Removed by Dialysis	Method	Dosage Adjustment for Renal Failure*		Supplement Dose After Hemodialysis
				GFR (mL/min)		
				10–50	<10	
ANALGESICS						
Acetaminophen 650 mg q4h	Liver	HD: Yes PD: No	I, D	No adjustment	q8h	No
Aspirin 650 mg q6h	Liver	Yes	D	50%	Avoid	Yes
Celecoxib (Celebrex) 100–200 mg q12h	Liver	No	D	Avoid if GFR <30 mL/min	Avoid	No
Codeine 30–60 mg q4–6h	Liver	No	D	75%	Avoid	No
Ibuprofen (Motrin) 400–800 mg q8h	Liver	No	—	No adjustment	Avoid	No
Meperidine ⁺ (Demerol) 50 mg q4h	Liver	No	D	75%	50%	No
Tramadol (Ultram) 50–100 mg q6h	Kidneys	No	I	q6–12h	50% q12h	Yes
ANESTHETICS						
Articaine, lidocaine, mepivacaine, prilocaine	Esterases (articaine), liver (lidocaine, mepivacaine, and prilocaine)	No	—	No adjustment		N/A
ADJUNCTIVE ANALGESIC						
Gabapentin (Neurontin) 200–600 mg q8h	Kidneys	Yes	D	200–600 mg q12–24h	<100 mg once daily	Yes
ANTIMICROBIALS						
Acyclovir—(Zovirax) 200–800 mg q4h	Kidneys	Yes	I, D	q8h	q12h	Yes
Amoxicillin 500 mg q8h	Kidneys	Yes	I	q8–12h	q12–24h	Yes
Azithromycin (Zithromax) 250–500 mg q24h	Liver	ND	—	No adjustment	Avoid	
Cephalexin (Keflex) 250–500 mg q6h	Kidneys	Yes	I	q6–8h	q12–24h	Yes
Clarithromycin 250 mg q12h	Liver	ND	D	50%–100% q12h	50% q12h	ND
Clindamycin (Cleocin) 150–300 mg q6h	Liver	No	D	No adjustment		No
Doxycycline (Vibramycin) 100 mg q12h	Liver	No	—	No adjustment		No
Erythromycin 250–500 mg q6h	Liver	No	—	No adjustment		No
Fluconazole (Diflucan) 100–200 mg q24h	Kidneys	Yes	D	50%	25%	Yes
Metronidazole (Flagyl) 250–500 mg q8–12h	Liver	Yes	—	No adjustment		Yes (HD)
Tetracycline [†] (Sumycin, Aureomycin) 250–500 mg q6–12h	Kidneys	No	I	Avoid	Avoid	No
BENZODIAZEPINE						
Diazepam (Valium), [‡] 2–5 mg q12h, triazolam (Halcion) 0.125 mg at bedtime	Liver	No	D	No adjustment		No

TABLE 12.4 Drug Adjustments in Chronic Renal Disease—cont'd

Drug and Usual Dose	Route of Elimination or Metabolism	Removed by Dialysis	Dosage Adjustment for Renal Failure*		Supplement Dose After Hemodialysis	
			Method	GFR (mL/min)		
				10–50		<10
CORTICOSTEROID						
Dexamethasone, hydrocortisone, prednisone 5–10 mg/day	Local site and liver	No	—	No adjustment	No	
SEDATIVE HYPNOTIC						
Chloral hydrate 250–500 mg/day	Liver and red blood cells, kidneys	Yes	—	Contraindicated		

*25% means 25% of usual dosage.

[†]Acyclovir, tetracyclines, and aminoglycosides are nephrotoxic and should be avoided in patients with chronic kidney disease (CKD). Cevimeline (Evovac), ceftriaxone, clindamycin, nafcillin, penicillin G, penicillin VK, and pilocarpine (Salagen) do not need dosage adjustment during CKD. Nonsteroidal antiinflammatory drugs can aggravate sodium retention and edema; full-dose aspirin can aggravate coagulopathy.

[‡]Use with great caution. Active metabolites can accumulate in renal failure; reduce dose if drug will be given longer than a few days.

D, Dosage reduction; *I*, interval extension between doses; *GFR*, glomerular filtration rate; *HD*, hemodialysis; *ND*, no data, *PD*, peritoneal dialysis; *q*, every. Modified from Aronoff GR, Bennett WM, Berns JS, et al: *Drug prescribing in renal failure: dosing guidelines for adults and children*, ed 5, Philadelphia, 2007, American College of Physicians and Golightly LK, Teitelbaum I, Kiser TH, Levin DA, et al, editors: *Renal pharmacology*, New York, 2013, Springer.

may have a characteristic ammonia-like odor, which results from a high urea content.^{36,37} Poor oral hygiene, halitosis, gingivitis, periodontal disease, and tooth loss are more common in patients with stage 3 or higher CKD.^{35,38,39}

Uremic stomatitis is a rare condition generally associated with acute renal failure and BUN levels are greater than 55 mg/dL. Early changes typically include red, burning mucosa covered with gray exudates and later by frank ulceration. Adherent white patches called *uremic frost* caused by urea crystal deposition are more common on the skin but may be seen on the oral mucosa and can resemble hairy leukoplakia. Bleeding tendencies are evident as petechiae and ecchymoses on the labial and buccal mucosa, soft palate, and margins of the tongue and as gingival bleeding³⁵ (Fig. 12.11).

Tooth-specific changes also may be seen. Enamel hypoplasia and hypocalcification are evident when ESRD begins at an early age. In the developing dentition, red-brown discoloration and a slight delay in eruption have been reported. Tooth erosion from persistent vomiting may be seen. Pulp narrowing or obliteration has been documented.^{15,38} Caries, however, is not a feature because salivary urea inhibits the metabolic end products of bacterial plaque and increases the buffering capacity of saliva, thus preventing a drop in pH sufficient to attain cariogenic levels.¹⁵

Specific osseous changes of the jaws accompany chronic renal failure. The most classically described osseous change is the triad of loss of lamina dura, demineralized bone (resulting in a “ground-glass” appearance), and localized and expansile radiolucent jaw lesions (central giant cell granulomas, also called brown tumors), the latter from secondary hyperparathyroidism. Other osseous findings

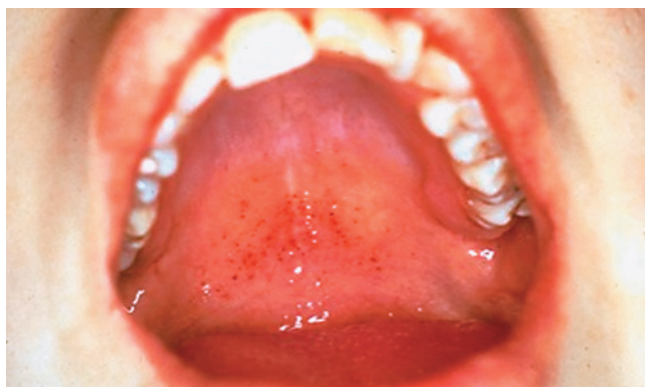

FIG 12.11 Palatal petechiae in a patient with end-stage renal disease.

include widened trabeculations, loss of cortication, calcified extraction sites (so-called “socket sclerosis”), and metastatic calcifications within soft tissue and the skull.¹⁵ Vascular calcifications of the carotid arteries are common.⁴⁰

Patients with CKD who take calcium channel blocker hypotensive medication as well as renal transplant recipients who take cyclosporine may exhibit gingival enlargement. The clinical presentation is similar to that caused by phenytoin (Dilantin).

Treatment Planning Modifications. Persons with CKD often exhibit evidence of poor oral hygiene, low salivary flow, and unmet dental needs. In these patients, the goal of restoring dental health must address these factors while balancing their medical needs. Oral hygiene instruction and frequent periodic recall appointments are important for the maintenance of long-term oral health. Meticulous oral hygiene, frequent professional prophylaxis, and

antiplaque measures (chlorhexidine or triclosan rinses) also help to reduce the effects of drug-induced gingival enlargement in transplant recipients taking cyclosporine. When an acceptable level of oral hygiene has been established, no contraindication exists to routine dental care, provided that proper attention is paid to the systemic health of the patient.

Patients Receiving Dialysis

Medical Considerations

Risk Assessment. In assessing risk for dental patients with kidney disease who receive dialysis, the dentist must consider the type dialysis, degree of kidney dysfunction, comorbidities (anemia, bone involvement, altered immune function and hemostasis), oral health status, and the dental procedure planned. For example, peritoneal dialysis presents no additional problems with respect to dental management. However, this is not the case with patients who are receiving hemodialysis (see [Box 12.1](#)). The arteriovenous fistula surgically created for the dialysis procedure in these patients is susceptible to infection (endarteritis) and may become a source of bacteremia, resulting in infective endocarditis. Infective endocarditis has been associated with hemodialysis even in the absence of preexisting cardiac defects.^{41,42} Although the risk factors for infective endocarditis in this setting have not been fully established, altered host defenses, altered cardiac output and mechanical stresses, and bacterial seeding and growth on the shunt are recognized as important.

Infective endocarditis occurs in 2% to 9% of patients receiving hemodialysis. This rate is significantly higher than that reported in persons with rheumatic heart disease. Most such infections are secondary to spread of staphylococcal infections that develop at the site of the graft, fistula, or catheter. Approximately 10% to 17% of cases are caused by organisms that can arise from the oropharynx (*Streptococcus viridans*, *Lactobacillus* spp.).⁴² The following devices are considered to place the patient at increased risk for bacterial seeding over that associated with primary arteriovenous fistulas: dual-lumen cuffed venous catheters and polytetrafluoroethylene grafts, newly placed grafts, and long-term catheters.

Recommendations

Antibiotics. On the basis of an apparently low risk associated with oral bacteria,⁴¹ the American Heart Association's 2003 guidelines⁴² do not include a recommendation for prophylactic antibiotics before invasive dental procedures are performed on patients with intravascular access devices to prevent endarteritis or infective endocarditis except if an abscess is being incised and drained ([Box 12.3](#)). This position is supported by systematic reviews of the literature.⁴³⁻⁴⁵

Risk of Infection. Patients who are dependent on long-term dialysis, especially those with diabetes, are prone to infection.^{46,47} In addition, rates of tuberculosis and vancomycin- and methicillin-resistant infections are higher among such patients than in the general public.²⁶ Thus,

BOX 12.3 Antibiotic Prophylaxis Recommendations for Use With Existing Nonvalvular Cardiovascular Devices

- Antibiotic prophylaxis is *NOT* routinely recommended after device placement for patients who undergo dental, respiratory, gastrointestinal, or genitourinary procedures.
- Antibiotic prophylaxis is recommended for patients with these devices if they undergo incision and drainage of infection at other sites (e.g., abscess) or replacement of an infected device.
- Antibiotic prophylaxis is recommended for patients with residual leak after device placement for attempted closure of the leak associated with patent ductus arteriosus, atrial septal defect, or ventricular septal defect.

Adapted from Baddour LM, Bettmann MA, Bolger AF, et al: AHA: Nonvalvular cardiovascular device-related infections, *Circulation* 108:2015-2031, 2003.

efforts should be directed at identifying signs of orofacial infections and eliminating oral sources of infection. Patients with active tuberculosis should not receive dialysis until the disease is rendered inactive (see [Chapter 7](#)). Selection of antibiotics for hemodialysis patients with oral infections should be prudent and based on appropriate criteria (see [Table 12.4](#)).

Patients who undergo hemodialysis also can benefit from periodic testing for hepatitis viruses and HIV, because vaccination or antiviral agents can be administered to reduce the risk of complications of these diseases. The dentist should be aware that a negative test result in the past is not predictive of their current status. Patients may have acquired the disease since they were last tested, or they may be carriers of other infectious viruses (e.g., Epstein-Barr virus, cytomegalovirus) that can cause hepatic injury (see [Chapter 10](#)) or immune deficiency. Accordingly, the use of standard infection control procedures is warranted for dental procedures performed in all patients.

Patients who are carriers of hepatitis viruses may have altered hepatic function and may be at risk for the development of liver cancer. Liver function should be assessed before hemorrhagic procedures are performed (see [Chapter 10](#)). Proper follow-up with the patient's physician is also advised.

Bleeding. Hemodialysis tends to aggravate bleeding tendencies through physical destruction of platelets and the associated use of heparin. Therefore, determination of the status of hemostasis is important before oral surgery is performed. Screening tests, such as activated partial thromboplastin time (aPTT) and platelet count, should be ordered. Higher risk occurs in patients who have elevated values on these laboratory tests and a history of GI bleeding (see [Chapter 24](#)). Although increased risk for bleeding is anticipated in these patients, several management modifications can be used to reduce the chance of serious bleeding:

- Providing dental treatment at the optimum time, usually on the day after hemodialysis, because on the day of dialysis, patients typically are fatigued and may have a tendency to bleed. The activity of heparin lasts for 3 to 6 hours after infusion, and delay of treatment is prudent until that medication is eliminated from the bloodstream.
- Obtaining primary closure and, as needed, using pressure and local hemostatic agents (e.g., absorbable gelatin sponge, thrombin, oxidized cellulose, absorbable collagen, chitosan dressing, and cyanoacrylate). Tranexamic acid can be used (see [Chapter 24](#)), but the dosage should be adjusted in consultation with the physician.
- Performing major surgical procedures on the day after the end of the week of hemodialysis treatment to provide additional time for clot retention before dialysis is resumed. For example, for a patient on a Monday, Wednesday, Friday weekly hemodialysis regimen, surgery performed on Saturday allows an additional day for clot stabilization before hemodialysis is resumed on Monday of the following week.
- Contacting the nephrologist, as indicated, to request that the heparin dose be reduced or eliminated during the first hemodialysis session after the surgical procedure. Of note, hemodialysis can be performed without heparin when hemostasis and clot retention are especially critical.
- Administering protamine sulfate (usually by a physician) if dental care is necessary the day of hemodialysis. This agent will block the anticoagulant effects of heparin.

Blood Pressure. The clinician should be aware of other cardiovascular considerations in patients undergoing hemodialysis. For example, the arm that contains the arteriovenous shunt should be protected from application of the blood pressure cuff, blood drawing, and the introduction of intravenous medications. An inflated blood pressure cuff or tourniquet may potentially collapse the shunt, rendering it useless. Likewise, venipuncture of the shunt should be avoided to prevent the complication of phlebitis that can occur from administration of intravenous medications and thrombus development that may jeopardize the shunt.

Capacity to Tolerate Care. Comorbid conditions such as cardiovascular disease and diabetes are common in patients receiving dialysis. Moreover, approximately 40% of patients on dialysis have congestive heart failure, and 39% of them die of cardiovascular complications each year.³⁹ These patients often take several medications to control hypertension, diabetes, congestive heart failure, or hypercoagulability (i.e., anticoagulation). Dental care must be provided only when the patient is medically stable, and treatment should be planned with an understanding of the required medications and the appropriate dental precautionary measures (see [Chapters 3, 4, 6, and 24](#)).³³

In addition, patients receiving dialysis are at increased risk of bone fracture, so appropriate precautions should be implemented.

Drug Considerations. Dentists should be aware that hemodialysis removes some drugs from the circulating blood; this may shorten the duration of effect of prescribed medications. The chance that a given drug will be dialyzed is governed by four factors: (1) molecular weight and size, (2) degree of protein binding,³¹ (3) volume of drug distribution, and (4) endogenous drug clearance.³⁰ For example, larger molecule (>500 daltons) drugs are poorly dialyzed. Drugs removed during hemodialysis are those with low capacity for binding to plasma proteins. However, uremia may greatly alter the normal degree of protein binding. A drug such as phenytoin that normally is highly protein bound exhibits lower plasma protein binding during uremia and is available to a greater extent for dialysis removal. Drugs with high lipid affinity exhibit high tissue binding and are not available for dialysis removal. Also, efficient liver clearing of a drug greatly reduces the effect of dialysis treatment.

In general, dosing of drugs should be tailored to occur after dialysis to ensure active drug levels are reached until the next dosing, and dosage amounts and intervals should be adjusted in accordance with current evidence (see [Table 12.4](#)) and advice from the patient's physician.^{28,48}

Oral Complications and Manifestations. Hemodialysis reverses many of the severe oral pathologic changes associated with ESRD. However, uremic odor, dry mouth, taste change, and tongue and mucosal pain are signs and symptoms that persist in many of these patients. Petechiae, ecchymoses, higher plaque and calculus indices, and lower levels of salivary secretion are more common among patients undergoing hemodialysis than healthy patients. Secondary hyperparathyroidism along with the associated osseous changes in the jaws has been reported in more than 30% of patients receiving hemodialysis; high levels of PTH are associated with increased mortality.⁴⁹

Patient With Renal Transplant

Approximately 190,000 ESRD patients have a functioning transplanted kidney.⁵⁰ Patients who have a transplanted kidney may require special management precautions, including the need for corticosteroids or antibiotic prophylaxis and the need for management of oral infection and gingival overgrowth caused by cyclosporine therapy (see [Chapter 21](#)).

REFERENCES

1. Foundation NK Global facts: about kidney disease. <https://www.kidney.org/kidneydisease/global-facts-about-kidney-disease>. Accessed 26 March 2016.
2. Saran R, Li Y, Robinson B, et al. US Renal Data System 2015 Annual Data Report: Epidemiology of Kidney Disease in the United States. *Am J Kidney Dis*. 2016;67(3 suppl 1):A7-A8.

3. Grams ME, Chow EK, Segev DL, et al. Lifetime incidence of CKD stages 3-5 in the United States. *Am J Kidney Dis.* 2013;62(2):245-252.
4. Levey AS, Coresh J, Balk E, et al. National Kidney Foundation practice guidelines for chronic kidney disease: evaluation, classification, and stratification. *Ann Intern Med.* 2003;139(2):137-147.
5. Stevens PE, Levin A, Kidney Disease: Improving Global Outcomes Chronic Kidney Disease Guideline Development Work Group M. Evaluation and management of chronic kidney disease: synopsis of the kidney disease: improving global outcomes 2012 clinical practice guideline. *Ann Intern Med.* 2013;158(11):825-830.
6. Landry DW, Bazari H. Approach to the patient with renal disease. In: Goldman L, ed. *Goldman-Cecil Medicine.* Philadelphia: Saunders/Elsevier; 2016:728-736.
7. National Kidney Foundation. K/DOQI Clinical practice guidelines for chronic kidney disease: evaluation, classification, and stratification. *Am J Kidney Dis.* 2002;39:S1-S266.
8. Inker LA, Astor BC, Fox CH, et al. KDOQI US commentary on the 2012 KDIGO clinical practice guideline for the evaluation and management of CKD. *Am J Kidney Dis.* 2014;63(5):713-735.
9. Carey WD, ed. *Cleveland Clinic: Current Clinical Medicine.* 2nd ed. St. Louis: Saunders; 2010.
10. Bargman JM, Skorecki K. Chronic kidney disease. In: Fauci AS, Braunwald E, Kasper DL, et al, eds. *Harrison's Principles of Internal Medicine.* New York: McGraw Hill; 2008:1761-1771.
11. United States Renal Data System. CKD in the general population. http://www.usrds.org/2015/view/v1_01.aspx. Accessed 26 March 2016.
12. Pun PH, Smarz TR, Honeycutt EF, et al. Chronic kidney disease is associated with increased risk of sudden cardiac death among patients with coronary artery disease. *Kidney Int.* 2009;76(6):652-658.
13. Galbusera M, Remuzzi G, Boccardo P. Treatment of bleeding in dialysis patients. *Semin Dial.* 2009;22(3):279-286.
14. Thomas R, Kanso A, Sedor JR. Chronic kidney disease and its complications. *Prim Care.* 2008;35(2):329-344, vii.
15. Proctor R, Kumar N, Stein A, et al. Oral and dental aspects of chronic renal failure. *J Dent Res.* 2005;84(3):199-208.
16. National Kidney and Urologic Diseases Information Clearinghouse (NKUDIC). Treatment Methods for Kidney Failure: Peritoneal Dialysis. 2010. Bethesda, MD. <http://kidney.niddk.nih.gov/kudiseases/pubs/peritoneal/>.
17. National Kidney Foundation. KDOQI Clinical Practice Guideline for Diabetes and CKD: 2012 Update. *Am J Kidney Dis.* 2012;60(5):850-886.
18. National Kidney Foundation. K/DOQI clinical practice guidelines for bone metabolism and disease in chronic kidney disease. *Am J Kidney Dis.* 2003;42(4 suppl 3):S1-S201.
19. Slinin Y, Greer N, Ishani A, et al. Timing of dialysis initiation, duration and frequency of hemodialysis sessions, and membrane flux: a systematic review for a KDOQI clinical practice guideline. *Am J Kidney Dis.* 2015;66(5):823-836.
20. National Institute of Diabetes and Digestive and Kidney Diseases. Kidney Disease Statistics for the United States. U.S. Department of Health and Human Services. <http://www.niddk.nih.gov/health-information/health-statistics/Pages/kidney-disease-statistics-united-states.aspx>. Accessed 28 March 2016.
21. Finelli L, Miller JT, Tokars JI, et al. National surveillance of dialysis-associated diseases in the United States, 2002. *Semin Dial.* 2005;18(1):52-61.
22. Liu KD, Chertow GM. Dialysis in the treatment of renal failure. In: Fauci AS, Braunwald E, Kasper DL, et al, eds. *Harrison's Principles of Internal Medicine.* New York: McGraw Hill; 2008:1772-1776.
23. Tokoff-Rubin N. Treatment of irreversible renal failure. In: Goldman L, Ausiello D, eds. *Cecil Medicine.* 23th ed. Philadelphia: Saunders Elsevier; 2008:936-947.
24. Tokars JI, Miller ER, Alter MJ, et al. National surveillance of dialysis-associated diseases in the United States, 1997. *Semin Dial.* 2000;13(2):75-85.
25. Marik PE, Varon J. Requirement of perioperative stress doses of corticosteroids: a systematic review of the literature. *Arch Surg.* 2008;143(12):1222-1226.
26. Centers for Disease Control, Prevention. Invasive methicillin-resistant *Staphylococcus aureus* infections among dialysis patients—United States, 2005. *MMWR Morb Mortal Wkly Rep.* 2007;56(9):197-199.
27. Aronoff GR, Bennett WM, Berns JS, et al. *Drug Prescribing in Renal Failure.* Philadelphia: American College of Physicians; 2007.
28. *Renal Pharmacotherapy: Dosage Adjustment of Medications Eliminated by the Kidneys.* New York: Springer; 2013.
29. Miller CS, McGarity GJ. Tetracycline-induced renal failure after dental treatment. *J Am Dent Assoc.* 2009;140(1):56-60.
30. Gabardi S, Abramson S. Drug dosing in chronic kidney disease. *Med Clin North Am.* 2005;89(3):649-687.
31. Plantinga LC, Crews DC, Coresh J, et al. Prevalence of chronic kidney disease in US adults with undiagnosed diabetes or prediabetes. *Clin J Am Soc Nephrol.* 2010;5(4):673-682.
32. De Rossi SS, Glick M. Dental considerations for the patient with renal disease receiving hemodialysis. *J Am Dent Assoc.* 1996;127(2):211-219.
33. Lockhart PB, Gibson J, Pond SH, et al. Dental management considerations for the patient with an acquired coagulopathy. Part 1: coagulopathies from systemic disease. *Br Dent J.* 2003;195(8):439-445.
34. Gavalda C, Bagan J, Scully C, et al. Renal hemodialysis patients: oral, salivary, dental and periodontal findings in 105 adult cases. *Oral Dis.* 1999;5(4):299-302.
35. Kho HS, Lee SW, Chung SC, et al. Oral manifestations and salivary flow rate, pH, and buffer capacity in patients with end-stage renal disease undergoing hemodialysis. *Oral Surg Oral Med Oral Pathol Oral Radiol Endod.* 1999;88(3):316-319.
36. Tomas I, Marinho JS, Limeres J, et al. Changes in salivary composition in patients with renal failure. *Arch Oral Biol.* 2008;53(6):528-532.

37. Kshirsagar AV, Moss KL, Elter JR, et al. Periodontal disease is associated with renal insufficiency in the Atherosclerosis Risk In Communities (ARIC) study. *Am J Kidney Dis.* 2005;45(4):650-657.
38. Davidovich E, Davidovits M, Eidelman E, et al. Pathophysiology, therapy, and oral implications of renal failure in children and adolescents: an update. *Pediatr Dent.* 2005;27(2):98-106.
39. Chambrone L, Foz AM, Guglielmetti MR, et al. Periodontitis and chronic kidney disease: a systematic review of the association of diseases and the effect of periodontal treatment on estimated glomerular filtration rate. *J Clin Periodontol.* 2013;40(5):443-456.
40. Lee JY, Antoniazzi MC, Perozini C, et al. Prevalence of carotid artery calcification in patients with chronic renal disease identified by panoramic radiography. *Oral Surg Oral Med Oral Pathol Oral Radiol.* 2014;118(5):612-618.
41. Robinson DL, Fowler VG, Sexton DJ, et al. Bacterial endocarditis in hemodialysis patients. *Am J Kidney Dis.* 1997;30(4):521-524.
42. Baddour LM, Bettmann MA, Bolger AF, et al. Nonvalvular cardiovascular device-related infections. *Circulation.* 2003;108(16):2015-2031.
43. Lockhart PB, Loven B, Brennan MT, et al. The evidence base for the efficacy of antibiotic prophylaxis in dental practice. *J Am Dent Assoc.* 2007;138(4):458-474, quiz 534-5, 437.
44. Oliver R, Roberts GJ, Hooper L, et al. Antibiotics for the prophylaxis of bacterial endocarditis in dentistry. *Cochrane Database Syst Rev.* 2008;(4):CD003813.
45. Termine N, Panzarella V, Ciavarella D, et al. Antibiotic prophylaxis in dentistry and oral surgery: use and misuse. *Int Dent J.* 2009;59(5):263-270.
46. Wakasugi M, Kawamura K, Yamamoto S, et al. High mortality rate of infectious diseases in dialysis patients: a comparison with the general population in Japan. *Ther Apher Dial.* 2012;16(3):226-231.
47. Christensen L, Evans H, Cundick D, et al. Necrotizing fasciitis case presentation and literature review. *N Y State Dent J.* 2015;81(4):24-28.
48. Matzke GR, Aronoff GR, Atkinson AJ Jr, et al. Drug dosing consideration in patients with acute and chronic kidney disease—a clinical update from Kidney Disease: Improving Global Outcomes (KDIGO). *Kidney Int.* 2011;80(11):1122-1137.
49. Tentori F, Wang M, Bieber BA, et al. Recent changes in therapeutic approaches and association with outcomes among patients with secondary hyperparathyroidism on chronic hemodialysis: the DOPPS study. *Clin J Am Soc Nephrol.* 2015;10(1):98-109.
50. National Kidney Foundation. Fast Facts. <https://www.kidney.org/news/newsroom/factsheets/FastFacts> - Ref. Accessed 28 March 2016.

Sexually Transmitted Diseases

DEFINITION

Sexually transmitted diseases (STDs) are a major global health problem. The worldwide burden is difficult to estimate across the more than 30 infectious diseases known to be transmitted through sexual contact (Box 13.1); however, the World Health Organization (WHO) reports there are almost 1 million new cases each day collectively for the four most prevalent reportable bacterial STDs, namely chlamydia, gonorrhea, trichomoniasis, and syphilis.¹ The Centers for Disease Control (CDC) has reported incidence estimates for these same four STDs of close to 5 million new infections per year in the United States.² Adding data for the four most prevalent viral STDs, namely human papillomavirus (HPV), herpes simplex virus (HSV), hepatitis B virus (HBV), and human immunodeficiency virus (HIV) infections, these eight STDs account for an incidence of 20 million new infections annually and a prevalence of 110 million new and existing infections combined in the United States.³ Of note, more than 50% of new infections occur in younger adults (aged 15–24 years). The cost to the U.S. health care system is estimated to be greater than \$15 billion.⁴ In a dental practice of 2000 patients, approximately 600 to 700 patients would be found to have a new or existing STD.

The morbidity and mortality of STDs vary from minor inconvenience to severe health consequences and death. The diagnosis of an STD can also have significant psychosocial effects. STDs have important implications for the dental team, and prompt recognition, diagnosis, and management of STDs are of paramount importance. Oral health care providers may intercept patients who have STDs while eliciting their history or by recognizing oral manifestations of STDs during the head and neck examination. However, it is important to remember that patients may not always divulge that they have a STD, or they may have asymptomatic disease and be unaware that they have an active infection. STDs can be transmitted by contact with blood, saliva, and oral lesions (if present) or, in the case of some viral STDs, via asymptomatic viral shedding. As such, the dental team should assume that all patients are potentially infectious and must adhere to standard infection control precautions (see Appendix B). A single STD is accompanied by additional STDs in about 10% of cases, and STDs increase the risk for HIV infection.^{5,6} Prevention is critical, and oral health care providers

can provide patient education to minimize transmission, particularly concerning oral contact.

Most dentists do not routinely obtain a sexual history on all patients but should be familiar with how to obtain a sexual history should the need arise (Box 13.2). An understanding about the epidemiology, etiopathogenesis (the cause and development of a disease or abnormal condition), clinical course and manifestations, diagnosis, and medical management of STDs can provide a strong basis for the identification of the oral manifestations and the dental considerations of patients with STDs. Discussion in this chapter is limited to gonorrhea, syphilis, selected human herpesvirus, and HPV infections because these entities are of special interest or importance to dental practice and serve to illustrate basic principles. Readers are referred to Chapters 10 and 18 for information about hepatitis B virus infection and HIV/AIDS.

COMPLICATIONS

Sexually transmitted diseases have important implications for clinical practice in dentistry: STDs are transmitted by intimate interpersonal contact, which can result in oral manifestations. Dental health professionals need to be cognizant of these manifestations as a basis for referral of patients for proper medical treatment. Some STDs can be transmitted by direct contact with lesions, blood, or saliva, and because many affected persons may be asymptomatic, the dentist should approach all patients as though disease transmission were possible and must adhere to standard precautions. A single STD is accompanied by additional STDs in about 10% of cases, and STD-associated genital ulceration increases the risk for HIV infection. Pathogens responsible for STDs can exhibit antimicrobial resistance, so proper treatment is essential.

Some STDs are incurable, but all are preventable. Patient interaction with dental health care workers can be an important component of STD control by providing opportunities for diagnosis, education, and information regarding access to treatment.

GONORRHEA

Gonorrhea is caused by *Neisseria gonorrhoeae*. Humans are the only natural hosts for this disease, and gonorrhea is transmitted almost exclusively via sexual contact,

BOX 13.1 Classification of Sexually Transmitted Diseases

Bacterial

Bacterial vaginosis	<i>Atopobium vaginae</i> , <i>Bacteroides</i> spp., <i>Fusobacterium</i> spp., <i>Gardnerella vaginalis</i> , <i>Mobiluncus</i> spp., <i>Mycoplasma hominis</i> , <i>Peptostreptococcus</i> spp., <i>Porphyromonas</i> spp., <i>Prevotella</i> spp., <i>Ureaplasma urealyticum</i>
Chancroid	<i>Haemophilus ducreyi</i>
Chlamydia	<i>Chlamydia trachomatis</i>
Giardiasis	<i>Giardia lamblia</i>
Gonorrhea	<i>Neisseria gonorrhoeae</i>
Granuloma inguinale (donovanosis)	<i>Klebsiella granulomatis</i>
Nongonococcal, non-chlamydial urethritis in men	<i>Mycoplasma genitalium</i> <i>Ureaplasma urealyticum</i>
Salmonellosis	<i>Salmonella</i> spp.
Shigellosis	<i>Shigella</i> spp.
Streptococcal infection	<i>Streptococcus</i> group B spp.
Syphilis	<i>Treponema pallidum</i>
Trichomoniasis	<i>Trichomoniasis vaginalis</i>

Ectoparasites

Pubic lice (crabs)	<i>Phthirus pubis</i>
Scabies	<i>Sarcoptes scabiei</i>

Fungal

Vulvovaginal candidiasis	<i>Candida</i> spp., <i>Torulopsis</i> spp.
--------------------------	---

Protozoal

Amebiasis	<i>Entamoeba histolytica</i>
Enterobiasis	<i>Enterobius vermicularis</i>

Viral

Condyloma acuminatum (genital warts)	Human papillomavirus infection (HPV-6, HPV-11)
Cytomegalovirus infection	Cytomegalovirus (CMV)
Genital herpes	Herpes simplex viruses (HSV-1, HSV-2)
HIV infection/acquired immunodeficiency syndrome (AIDS)	Human immunodeficiency virus (HIV)
Hepatitis B	Hepatitis B virus (HBV)
Hepatitis C	Hepatitis C virus (HCV)
Molluscum contagiosum	Poxvirus
Zika virus infection	Zika virus

whether genital–genital, oral–genital, or rectal–genital. Gonorrhea primarily infects the urethra, cervix, rectum, and oropharynx, although it also can infect other sites such as the conjunctiva.

EPIDEMIOLOGY

Of the three nationally reported notifiable STDs (chlamydia, gonorrhea, and syphilis), gonorrhea is the second

BOX 13.2 Taking a Sexual History

Partners

- Are you currently sexually active? (Are you having sex?)
 - If no, have you ever been sexually active?
- In recent months, how many sex partners have you had?
- In the past 12 months, how many sex partners have you had?
- Are your sex partners men, women, or both?

Practices

- I am going to be more explicit here about the kind of sex you've had over the past 12 months to better understand if you are at risk for sexually transmitted diseases (STDs).
- What kind of sexual contact do you have or have you had? Genital (penis in the vagina)? Anal (penis in the anus)? Oral (mouth on penis, vagina, or anus)?

Past History of STDs

- Have you ever been diagnosed with an STD? When? How were you treated?
- Have you had any recurring symptoms or diagnoses?
- Have you ever been tested for HIV or other STDs?
- Has your current partner or any former partners ever been diagnosed or treated for an STD? Were you tested for the same STD(s)?
- If yes, when were you tested? What was the diagnosis? How was it treated?

Protection From STDs

- Do you and your partner(s) use any protection against STDs?
- If so, what kind of protection do you use?
- How often do you use and have you used protection?

Adapted from the U.S. Department of Health and Human Services, Centers for Disease Control and Prevention, Atlanta, GA, 2014: *Guide to taking a sexual history*. <https://www.cdc.gov/std/treatment/sexualhistory.pdf>.

most common behind chlamydia with an incidence of 350,062 new cases reported in the United States to the CDC in 2014 (i.e., 110.7 cases per 100,000 persons). This represents an increase in 10 cases per 100,000 over the previous 5-year interval.² Marginally more new cases were reported in men than women; more than 50% of cases are in 15- to 24-year old individuals; and the incidence among non-Hispanic blacks are more than 10 times the rates among whites, although the rates in blacks show a decreasing trend.

ETIOPATHOGENESIS

N. gonorrhoeae, an aerobic gram-negative β -proteobacteria, typically exists as diplococci with pili (hairlike surface structures) and a marked tropism for human mucosae. It replicates easily in warm, moist areas and preferentially requires high humidity and a specific temperature and pH for optimum growth. It is a fragile bacterium that is readily killed by drying, so it is not easily transmitted by fomites. *N. gonorrhoeae* displays differential invasiveness based on the type of host epithelium with which it interacts. Columnar epithelium (as found in the mucosal

lining of the urethra and cervix) and transitional epithelium (as in the pharynx and rectum) are highly susceptible to infection, but stratified squamous epithelium (skin and mucosal lining of the oral cavity) is generally resistant to infection. Fig. 13.1 depicts the areas of relative epithelial susceptibility to *N. gonorrhoeae* infection in the oral cavity and oropharynx.

N. gonorrhoeae demonstrates a propensity for antibiotic resistance, which has become a major global issue.⁷

CLINICAL PRESENTATION

Infection in men usually begins in the anterior urethra after sexual exposure and a 2- to 5-day incubation period. Typically, the acute infection is symptomatic and leads to urethritis, a purulent urethral discharge, and dysuria. Asymptomatic infection can occur in a minority of men. The infection may remain localized or may extend posteriorly to involve the epididymis, prostate, seminal vesicles, or bladder. Epididymitis can lead to infertility.

In contrast to men, infection in the majority of women is asymptomatic, which is problematic because patients may not seek medical care for their problem and as a result constitute a reservoir of infection. The incubation takes 5 to 10 days. Most symptomatic infections lead to a cervicitis with resultant purulent drainage and dyspareunia and less commonly urethritis. Bartholin glands and Skene ducts may also be affected. An ascending infection may involve the endometrium, fallopian tubes, ovaries, and pelvic peritoneum, and gonorrhea is a common cause of pelvic inflammatory disease (PID), which affects about 1 million women each year in the United States. PID can be symptomatic (backache and abdominal pain may be present) and may contribute to tubal scarring, leading to infertility or ectopic pregnancy. Perinatal transmission accounts for a small percentage of cases of gonorrhea in the United States, causing gonococcal conjunctivitis and arthritis of the newborn, which if untreated can cause blindness or joint infection.

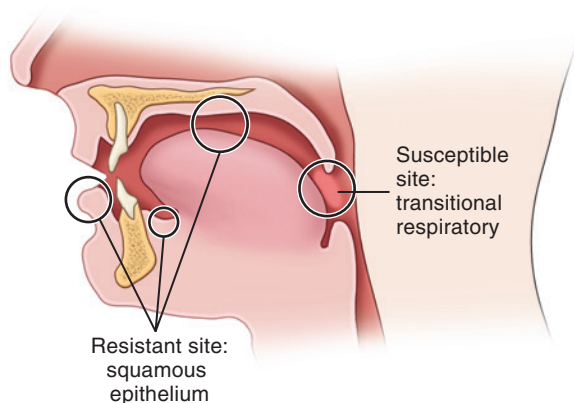

FIG 13.1 Areas of relative epithelial susceptibility to infection by *Neisseria gonorrhoeae* within the oral cavity or oropharynx.

In both genders, anorectal gonorrhea may occur after anal–genital intercourse. It is commonly less intense than genital infection, but similar symptoms, including a copious purulent discharge, soreness, and pain, may be noted. Pharyngeal infection is detected in 3% to 7% of heterosexual men, 10% to 20% of heterosexual women, and 10% to 25% of homosexual men, and the lower rates in heterosexual men support that it is more likely to occur after fellatio compared with cunnilingus or oral–oral contact. Oropharyngeal infection is typically asymptomatic or manifests as a mild sore throat and clinically is associated with diffuse, nonspecific inflammation. In symptomatic cases, the oropharynx may appear erythematous, with tiny pustules (Fig. 13.2), and can involve the palatine tonsils, which become enlarged with or without a yellowish exudate,⁸ and may be associated with cervical lymphadenopathy. The likelihood of transmission of pharyngeal gonorrhea to the genitalia is less common than that of genital–pharynx or genital–genital transmission. Disseminated gonorrhea also can occur infrequently (1%–2% of cases) and may result in a variety of disorders, including migratory arthritis, skin and mucous membrane lesions, endocarditis, meningitis, PID, and pericarditis.

LABORATORY AND DIAGNOSTIC FINDINGS

In symptomatic patients with a purulent discharge, Gram stain (or methylene blue/gentian violet) demonstrating gram-negative diplococci within neutrophils is the best point-of-care diagnostic for *N. gonorrhoeae* infection (Fig. 13.3).⁹ In an asymptomatic patient or a patient without purulent discharge (as may be the case in endocervical, rectal, or pharyngeal infections), Gram staining has poor accuracy and is not indicated.

Culture and nucleic acid amplification testing (NAAT) are both widely available for gonorrhea testing. The CDC recommends NAAT as the first-line diagnostic for *N. gonorrhoeae*, for both symptomatic and asymptomatic genital tract and for extragenital site infections, although the U.S. Food and Drug Administration (FDA) has only



FIG 13.2 Gonococcal infection of the oropharynx.

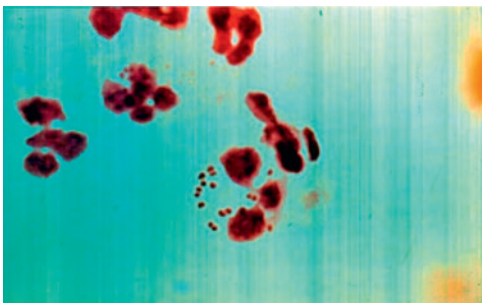

FIG 13.3 Smear demonstrating gram-negative diplococci within neutrophils. (Source: <http://www.public-domain-image.com/free-images/science/microscopy-images/gonorrhea-neisseria-gonorrhoeae/histopathology-in-an-acute-case-of-gonococcal-urethritis-using-gram-stain-technique/attachment/histopathology-in-an-acute-case-of-gonococcal-urethritis-using-gram-stain-technique>.)

approved NAAT platforms in genital tract infections.¹⁰ Given the strong likelihood for co-infection with *C. trachomatis*, these platforms are typically bundled to test for both organisms. Culture for *N. gonorrhoeae* is indicated in patients who have received a CDC-recommended antimicrobial regimen and yet have a persistent NAAT-positive result. Culture can be coupled with antimicrobial sensitivity testing, which is important given the propensity of *N. gonorrhoeae* for antimicrobial resistance.

MEDICAL MANAGEMENT

Because of antimicrobial sensitivity, the CDC has updated treatment recommendations¹⁰ and now recommends dual therapy of a single dose of ceftriaxone 250 mg intramuscularly (IM) plus a single dose of azithromycin 1 g orally for the treatment of uncomplicated gonococcal infection of the cervix, urethra, pharynx, or rectum in adults (regimens for other sites, children, or during pregnancy are different). An alternative regimen, when ceftriaxone is unavailable, is a single dose of cefixime 400 mg orally plus the azithromycin 1 g orally. For patients with a cephalosporin allergy, the CDC recommends a single dose of gemifloxacin 320 mg orally plus a single dose of azithromycin 2 g orally or a single dose of gentamicin 240 mg IM plus a single dose of azithromycin 2 g orally. All sexual partners should be tested and treated, and patients who have been treated yet who have persistent signs or symptoms should undergo culture and antibiotic sensitivity testing.

DENTAL CONSIDERATIONS

A patient with a known recent gonorrhea infection that has been administered appropriate antibiotic therapy poses little threat of disease transmission to the dental team. Patients in this category can receive dental care within days

of beginning antibiotic treatment. Patients with an active pharyngitis and other oral signs or symptoms suggestive of an active infection of unclear etiology should be promptly referred to a physician for further evaluation.

ORAL MANIFESTATIONS

Reports of gonorrhea involving the oral cavity (i.e., sites other than the oropharynx) are rare and summarized in two reviews.^{8,11} Encountering patients with a symptomatic pharyngitis warrants referral for further evaluation.

SYPHILIS

Syphilis is an STD caused by *Treponema pallidum*. As with gonorrhea, humans are the only known natural hosts for syphilis. Broadly, there are early infectious stages (known as primary and secondary syphilis), and if untreated, there is a latent stage followed by a noninfectious late stage (tertiary syphilis). Late stage manifestations are diverse and have led to the historical designation of syphilis as the “great imitator” disease, which includes the imitation of malignancy. The primary site of syphilitic infection is the genitalia, although primary lesions also occur extragenitally, including the oral cavity. Congenital syphilis is also possible. Syphilis remains an important infection in contemporary medicine because of the morbidity it can cause.

EPIDEMIOLOGY

Of the three nationally reported notifiable STDs, syphilis is the least common with an incidence of 19,999 new primary and secondary syphilis cases reported in the United States to the CDC in 2014 (i.e., 6.3 cases per 100,000 persons),² a rate that has almost doubled over the past decade. The estimated number of new and existing infections (i.e., including all stages of syphilis prevalence) in 2014 was 63,450. More than 10 men are infected for every woman, with the highest incidence in black men, although the greatest increases have been reported in men who have sex with men (MSM), which is concerning because of the increased risk for the transmission of HIV infection.

Congenital syphilis occurs when a fetus is infected in utero by an infected mother. In 2014, a rate of 11.6 per 100,000 live births was reported, demonstrating an increasing trend since 2012.

ETIOPATHOGENESIS

Treponema pallidum is a slender, fragile microaerophilic spirochete. It is transmitted predominantly sexually, by genital–genital, oral–genital, or rectal–genital contact with contaminated sores. However, transmission also may occur through kissing¹² or as a bloodborne infection and may be transmitted to fetuses, leading to congenital syphilis.

T. pallidum is easily killed by heating, drying, disinfecting, and using soap and water; as such, transmission by fomites is unlikely. It is believed that *T. pallidum* does not invade completely intact skin; however, it can invade intact mucosal epithelium and gain entry via minute abrasions or hair follicles. Within a few hours after invasion, spread to the lymphatics and the bloodstream occurs, resulting in early widespread dissemination of the disease. The risk of transmission occurs during the primary, secondary, and early latent stages of disease but not in late syphilis.

CLINICAL PRESENTATION

The clinical manifestations of syphilis are classically divided according to stages of disease, with each stage having its own unique signs and symptoms. These stages are primary, secondary, latent, tertiary, and congenital. Patients are most infectious during the first 2 years of the disease. It is important to note that many infected persons do not develop symptoms for years, yet they remain at risk for late complications if not treated.

Primary Syphilis

This stage is characterized by the chancre, a solitary (although multiple chancres are possible) round, often painless, somewhat firm lesion that develops at the site of contact with the infectious organism. The chancre usually occurs within 2 to 3 weeks (range, 10–90 days) after exposure (Figs. 13.4 and 13.5), and patients are infectious before it appears. The lesion begins as a small



FIG 13.4 Primary syphilis: chancre of the penis. (From Habib TP, Campbell JI Jr, Chapman MS, et al: *Skin disease: diagnosis and treatment*, ed 2, St. Louis, Mosby, 2005.)

papule and enlarges to form a surface erosion or ulceration that commonly is covered by a yellowish hemorrhagic crust that is teeming with *T. pallidum*. Enlarged, painless, and firm regional lymphadenopathy is typically present. The chancre usually subsides in 3 to 6 weeks without treatment, leaving variable scarring in the form of a healed papule. More than 80% of chancres occur on the genitalia, and the most common extragenital site is the oral cavity or oropharynx (others include the fingers, nipples, perineum, anus, and rectum). If adequate treatment is not provided, the infection progresses to secondary syphilis.

Secondary Syphilis

The manifestations of secondary syphilis appear 6 to 8 weeks after initial exposure and are associated with the hematogenous spread and associated systemic immunologic response to *T. pallidum*. The chancre may or may not have completely resolved by this time. There is a wide spectrum of systemic signs and symptoms, including fever, malaise, headache, arthralgias, generalized lymphadenopathy, and patchy hair loss and a generalized eruption of the skin and mucous membranes, including the oral cavity (see [Oral Manifestations](#) section). In some cases, secondary syphilis can be asymptomatic. The skin rash is maculopapular (Fig. 13.6, A) with well-demarcated and reddish brown areas involving the trunk and with a predilection for the palms and soles; they are typically not itchy. Warty lesions, known as condyloma lata, may involve the genitalia, the oral cavity, or both. Lues maligna is a rare and severe manifestation of secondary syphilis in immunocompromised patients, such as those with HIV infection.¹³ The lesions of skin and mucous membranes are highly infectious. Without treatment, secondary syphilis ultimately



FIG 13.5 Chancre on the tongue seen in primary syphilis. (From Ibsen DAC, Phelan JA: *Oral pathology for the hygienist*, ed 4, St. Louis, Saunders, 2003.)

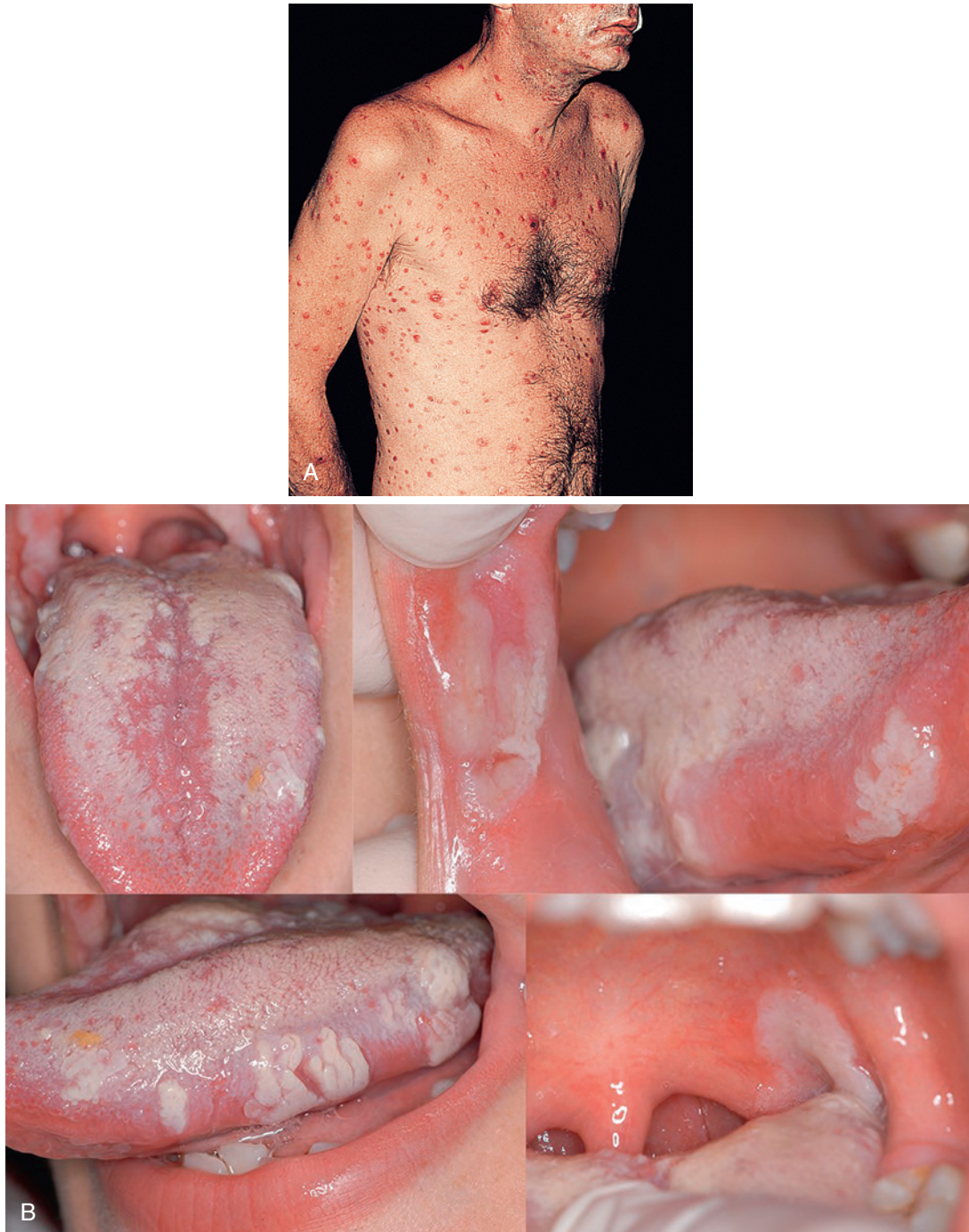

FIG 13.6 Lesions of secondary syphilis. **A**, Profuse papular rash. **B**, Multiple oral lesions, including mucous patches, and nonwipeable white plaques. (A, From Habib TP, Campbell JI Jr, Chapman MS, et al: *Skin disease: diagnosis and treatment*, ed 2, St. Louis, Mosby, 2005. B, From Dr. Stefania Leuci, Federico II University of Naples, Italy.)

resolves; however, infection progresses to latent or late stages.

Latent Syphilis

Latent syphilis is defined as the third stage of the untreated infection. Patients are seroreactive but are asymptomatic and do not show clinical evidence of disease. Latent syphilis

is divided into early latent syphilis (i.e., disease acquired within the preceding year) and late latent syphilis (>1 year). During the first 4 years of latent syphilis, patients may have mucocutaneous relapses and are considered infectious. After 4 years, relapses typically do not occur, and patients are considered noninfectious. The latent stage may last for many years or even for the remainder of the

person's life. In some untreated patients, however, progression to tertiary syphilis occurs.

Tertiary Syphilis

The tertiary (late) stage occurs in 10% to 40% of untreated persons, generally several years after disease onset. It is the destructive stage of the disease, although patients are considered noninfectious. Any organ of the body may become involved, and some have classified tertiary disease into three subtypes: neurosyphilis, cardiovascular, and gummatous disease. Neurosyphilis can result in a meningitis-like syndrome, Argyll Robertson pupils (which react to accommodation but not to light), altered tendon reflexes, general paresis, tabes dorsalis (degeneration of dorsal columns of the spinal cord and sensory nerve trunks), difficulty in coordinating muscle movements, or insanity. Cardiovascular syphilis is essentially vascular in nature and the end product of an obliterative endarteritis. This can lead to carotid and aortic stenosis and may ultimately manifest as an aneurysm of the ascending aorta. The gumma, which is the classic localized lesion of tertiary syphilis, may involve the skin, mucous membranes (including the oral cavity), bone, or within any organ. It is believed to be the end result of a hypersensitivity reaction and is basically a noninfectious inflammatory granulomatous lesion with a central zone of necrosis.

Congenital Syphilis

Syphilis may occur congenitally if the mother is infected while pregnant (i.e., secondary to treponemal bacteremia), and transplacental infection can occur as early as 9 to 10 weeks in utero. Approximately 25% of pregnancies result in stillbirth, and 12% result in neonatal death.¹⁴ The majority of newborns (>80%) are asymptomatic. The disease persists worldwide because a substantial number of women do not receive antenatal syphilis testing. There are early and late clinical manifestations.¹⁵ Early signs, manifesting at birth or up to 2 years after birth, may include hepatomegaly and associated liver dysfunction, hematologic abnormalities, mucocutaneous findings (i.e., maculopapular rash, a rhinitis secondary to nasal inflammation, perioral and perineural condylomata lata), and bone changes (osteochondritis and periostitis causing pseudoparalysis) and, less commonly, neurologic manifestations. Late stage congenital syphilis is rare, and there is a classic triad of congenital syphilis known as Hutchinson's triad that includes interstitial keratitis of the cornea, eighth nerve deafness, and dental abnormalities (see [Oral Manifestations](#)). In addition, rhinitis can lead to a saddle nose caused by cartilage destruction, rhagades, neurologic sequelae (including mental retardation), and bony abnormalities such as frontal bossing.

LABORATORY AND DIAGNOSTIC FINDINGS

T. pallidum has never been cultured successfully on any type of medium and is difficult to stain for microscopic

examination. Historically, the definitive diagnosis of syphilis has been made from microscopic examination of fresh lesion exudates during the primary and early secondary stages using positive dark-field microscopic examination. Other direct testing includes direct fluorescence antibody (DFA) tests or polymerase chain reaction (PCR). However, such testing is no longer widely available, not indicated to detect all stages of syphilis, and cannot be used to monitor the disease after treatment. With the advent of serologic tests, the traditional diagnosis of syphilis is based on clinical findings in conjunction with a two-step testing algorithm using a nontreponemal "screening" test followed by a confirmatory specific treponemal test.

Nontreponemal Testing

The nontreponemal tests include the Venereal Disease Research Laboratory (VDRL) slide test and the rapid plasma reagin (RPR) test. These tests, both equally valid but noncomparable, detect an antibody-like substance called reagin, which is a surrogate for the immunologic response to a syphilis infection. They are less specific but can better assess current disease activity. The initial test is qualitative, and if positive, a quantitative step is performed that generates "titers" values reported as serologic dilutions (e.g., 1:2, 1:4, 1:8). They are consistently positive and yield the highest titers between 3 and 8 weeks after the appearance of the primary chancre. A fourfold change in titers (e.g., 1:4 to 1:16 or 1:32 to 1:8) is the threshold signifying a clinically meaningful change in serial test results. In primary syphilis, nontreponemal test results usually revert to negative within 12 months after successful treatment. In secondary syphilis, up to 24 months may be required for the patient to become seronegative. Occasionally, a patient will remain seropositive for the rest of his or her life or will test positive with an associated infection or condition (false positive). With tertiary syphilis, many patients remain seropositive for life.

Treponemal Testing

These include the fluorescent treponemal antibody absorption test (FTA-ABS), *T. pallidum* particle agglutination assay (TPPA), *T. pallidum* hemagglutination assay (TPHA), and various immunoassays (i.e., enzyme immunoassays [EIAs], chemiluminescent immunoassays [CIAs], and microbead immunoassays [MIAs]). These are highly specific, but a positive test result cannot differentiate between current and past infection because antibodies remain positive in most patients.

A newer three-step "reverse" algorithm has been adopted with the intent to better capture those with a past history of infection and early stage disease. A treponemal immunoassay is performed first and if reactive is followed by a qualitative nontreponemal test. If this second test result is negative, a final quantitative nontreponemal test is performed. Recently, the FDA has approved a rapid point-of-care treponemal screening test

known as the Syphilis Health Check. These point-of-care tests have similar performance to the laboratory treponemal tests and may facilitate screening in resource limited settings.¹⁶

MEDICAL MANAGEMENT

Testing for concomitant HIV infection and the diagnosis and management of infection in the patient's sexual partners are recommended. Parenteral injection of long-acting benzathine penicillin G, 2.4 million IU IM in a single dose, remains the recommended and predictable treatment for primary, secondary, or early latent syphilis in adults; 50,000 IU/kg of penicillin G should be used for children or infants.¹⁷ As with gonorrhea, infectiousness is reversed rapidly, probably within a matter of hours after injection. A more intensive regimen is indicated for those with late latent or tertiary syphilis: injections of 2.4 million IU IM once a week for 3 weeks (i.e., total of 7.2 million IU). Neurosyphilis or ocular syphilis is managed more effectively with either 18 to 24 million IU of aqueous crystalline penicillin G delivered intravenously (IV) or 2.4 million IU procaine penicillin G given IM daily plus probenecid 500 mg four times a day, with both regimens given over a 10- to 14-day period. Neonates with possible congenital syphilis should be assessed by means of clinical, radiographic, and laboratory tests of blood and cerebrospinal fluid (CSF) for VDRL. If results prove presence of the disease or suggest that syphilis is highly probable, then the infant should be treated with IV penicillin G for at least 10 days. The first-line drug for patients allergic to penicillin (except for pregnant patients) is oral doxycycline (100 mg orally twice a day for 2 weeks) or tetracycline 500 mg four times a day for 2 weeks. Desensitization to penicillin is recommended for pregnant patients allergic to penicillin. Patients with primary or secondary syphilis who are otherwise immunocompetent should be retested at 6 and 12 months to monitor for seroconversion. HIV-infected patients and those with late latent or tertiary syphilis require more intensive or longer surveillance, respectively. The Jarisch-Herxheimer reaction is an acute febrile reaction that is frequently accompanied by chills, myalgias, and headache that occur within 24 hours after initiation of antibiotic therapy for syphilis. It occurs most often (i.e., in 50% patients) after treatment for early syphilis.

DENTAL CONSIDERATIONS

Lesions of untreated primary and secondary syphilis are infectious, as are the patient's blood and saliva. Even after treatment has begun, its absolute effectiveness cannot be determined except through conversion of the positive serologic test to negative; however, early reversal of infectiousness is to be expected after antibiotic treatment has been initiated. The time required for this conversion varies from a few months to longer than 1 year. Therefore,

patients who are currently under treatment or who remain seropositive for syphilis after receiving treatment should be viewed as potentially infectious. Still, any necessary dental care may be provided with adherence to standard precautions unless oral lesions are present. Dental treatment can commence after oral lesions have been successfully treated.

ORAL MANIFESTATIONS

Oral syphilitic chancres and mucous patches are usually painless unless they become secondarily infected. Both lesions are highly infectious. Oral chancres (see Fig. 13.4) are typically solitary lesions that may involve the lips, tongue, oropharynx, or other oral sites and may be associated with lymphadenopathy.^{18,19} They begin as a round papule that erodes into a painless ulcer with a smooth surface. Size can vary from a few millimeters to more than 2 cm. Sometimes chancres may demonstrate induration. The oral manifestations of secondary syphilis (present in >30% of patients) (Fig. 13.6, B) are highly variable and include single or multiple lesions such as mucous patches, maculopapular lesions (i.e., the likely counterpart to the skin rash), erosions, ulcerations including a peculiar "snail-track" variety, white plaques resembling leukoplakia,²⁰ and papulonodular lesions.¹⁹ The intraoral mucous patch is often asymptomatic and appears as a slightly raised grayish plaque and may involve multiple oral sites.²¹ The oral gumma of tertiary syphilis is rare. It typically presents as a solitary lesion that most commonly involves the tongue and palate, which may be exophytic, indurated, and with surface ulceration. Palatal gummas may erode bone and perforate into the nasal cavity or maxillary sinus, creating an oronasal or oral-antral fistula. An atrophic or interstitial glossitis has also been reported in tertiary syphilis.²² Oral manifestations of congenital syphilis include peg-shaped permanent central incisors with notching of the incisal edge (Hutchinson's incisors) (Fig. 13.7), defective molars with multiple supernumerary cusps (mulberry molars),²³ a high narrow palate, and perioral rhagades (skin fissures).

The manifestations of syphilis, the "great imitator," can mimic malignant neoplasms; however, the evidence



FIG 13.7 Congenital syphilis: Hutchinson's teeth.

for syphilis as a causative agent for cancer is not clear. Historically, syphilis has been identified as a risk factor for oral squamous cell carcinoma, particularly of the tongue in patients with syphilitic glossitis associated with tertiary syphilis,²⁴ although case control studies with multivariate analyses controlling for other risk factors have not been performed.

GENITAL HERPES SIMPLEX VIRUS INFECTIONS

Genital herpes is an incurable painful infection involving the anogenital region that is caused by one of two closely related types of HSV type 1 and type 2. The disease consists of acute and recurrent phases and is associated with high rates of subclinical infection and asymptomatic viral shedding.

EPIDEMIOLOGY

Genital herpes is an important STD in the United States and the world. Seroprevalence for genital HSV infection is challenging to assess. The serologic presence of antibodies to these viruses is indicative of past infection. HSV-2 antibodies correlate to a sexual or genital transmission, but it is difficult to differentiate between oral versus genital HSV-1 infection. Recent data from a genital herpes vaccine trial in a cohort of baseline HSV-seronegative women aged 18 to 30 years revealed that more than twice as many incident primary genital infections are caused by HSV-1, suggesting increasing trend in oral–genital transmission.²⁵ A current conservative estimate for genital herpes caused by HSV-1 infection is 50%, and this translates to a global genital HSV seroprevalence (for 15- to 49-year-old individuals) estimated of at least 544 million.²⁶ The CDC reports approximately 24 million Americans have HSV-2 infection, with more than 750,000 new infections annually.³ Yet these estimates do not include HSV-1 infection, and data from the National Health and Nutrition Examination Survey (NHANES) study reported seroprevalence for HSV-1 and HSV-2 in the general U.S. population (from 2005–2010) of 53.9% and 15.7%, respectively,²⁷ suggesting a significant underestimation of genital herpes for the general population. HSV-2 seroprevalence is approximately twice as high for women (22%) as men (11%) and almost three times as high for non-Hispanic blacks (56%) as whites (21%).²⁸ HSV-2 infection is associated with three times the risk for acquiring HIV infection.⁶

ETIOPATHOGENESIS

Herpes simplex virus belongs to a family of eight human herpesviruses that includes cytomegalovirus (CMV), Epstein-Barr virus (EBV), varicella-zoster virus, human herpesvirus type 6 (HHV-6), human herpesvirus type 7 (HHV-7), and Kaposi sarcoma–associated herpesvirus

(HHV-8). HSV-1 is the causative agent of most herpetic infections that occur above the waist, especially involving the oral mucosa (i.e., primary herpetic gingivostomatitis, recurrent herpes labialis, and recurrent intraoral herpes), nasal mucosa, eyes, brain, and skin. The majority of primary infections with HSV-1 are subclinical and thus are never known to the infected person. Transmission to others usually occurs through close contact through transfer of infective saliva such as touching, kissing, or oral sexual contact. Autoinoculation via the face, fingers, eyes, and genitalia may also occur. HSV-2 is transmitted predominantly by sexual contact, primarily through contact with an asymptomatic viral shedder, although it may also be transmitted nonsexually. HSV may also be transmitted to a newborn from an infected mother (neonatal herpes).²⁹

The pathogenesis of HSV-1 and HSV-2 infections are similar, and the lesions of skin and mucous membranes have a similar appearance. During the initial exposure, epithelial and epidermal and other permissive cells are “invaded” (i.e., viral particles attach and fuse with cell membranes, or the entire virion may be enveloped by cell membranes, via a series of glycoprotein interactions), and viral replication occurs. Characteristic cellular changes include ballooning degeneration, intranuclear inclusion bodies, and the formation of multinucleated giant cells. With cellular destruction comes inflammation and increasing edema, which result in formation of papules that progress to fluid-filled vesicles. These vesicles rupture, leaving an ulcerated surface that if exposed to the air will eventually crust over.

During the primary infection, progeny enter the ends of local peripheral neurons and migrate up the axon to the regional ganglia (HSV-1 primarily in the trigeminal and HSV-2 primarily in the sacral ganglia, respectively), where they reside as a latent infection. A “nonprimary” infection is also possible, defined as the first infection by HSV in an individual who already has been infected with the other type. The virus reactivates after exposure to trauma, sunlight, menses, intercourse, or immune suppression. The reactivated progeny migrate down the axon and can produce a recurrent infection with lesions similar to the primary infection, albeit typically less severe in nature and more localized.

CLINICAL PRESENTATION

The clinical manifestations of genital herpes are divided into primary and recurrent infections.

Primary Infection

The clinical course of the primary infection is variable, but lymphadenopathy and viremia are prominent features. In otherwise immunocompetent individuals, the infection is contained by the host’s immune system and runs its course within 10 to 20 days. However, spread to other epidermal sites (e.g., herpetic whitlow [infection of the fingers], keratoconjunctivitis [eyes]) and in neonates during

childbirth has been documented. In rare cases, infants and immunosuppressed persons can develop systemic and widespread infection that may result in significant morbidity and death.

Newly acquired genital infections may be symptomatic in approximately two thirds of HSV-1 and 40% of HSV-2 infections, and of those that are asymptomatic, a greater percentage occur in men.³⁰ After an incubation period of 2 to 10 days, the lesions of primary genital herpes may appear. In women, both internal and external genitalia may be involved, as well as the perineal region and the skin of the thighs and buttocks. In men, the external genitalia and the skin of the inguinal area may be involved. Lesions in moist areas tend to ulcerate early and are painful and, depending on their location, may cause dysuria. Lesions on exposed dry areas tend to remain pustular or vesicular and then crust over. Painful regional lymphadenopathy accompanies infection along with headache, malaise, myalgia, and symptoms of fever. These subside in approximately 2 weeks, and healing occurs in 3 to 5 weeks.

Recurrent Infection

Outbreaks of recurrent genital herpes typically occur two to six times per year and are generally less severe than the primary infection. Of the two HSV serotypes that can infect the sacral ganglia, HSV-2 is more efficient in reactivating; genital recurrences in those infected by HSV-2 are about four times as likely as those infected with HSV-1.³¹ Also, immune suppression increases the risk for more frequent and severe recurrences. A prodrome of localized itching, tingling, paresthesia, pain, and burning may be noted and is variably followed by a vesicular eruption (Fig. 13.8). Healing occurs in 10 to 14 days. Constitutional symptoms are generally absent.

HSV-1 and HSV-2 lesions are highly infectious and therefore can be transmitted to other individuals or to other sites on the patient. The infectious period of herpetic lesions is of uncertain length, but positive viral cultures are detected most often from stages before crusting. Therefore, one should assume that all herpetic lesions (i.e., papular, vesicular, pustular, and ulcerative) before completion of crusting are infectious. Between recurrences, infected persons intermittently shed the virus from the anogenital region (i.e., asymptomatic shedding), which can also lead to transmission.

LABORATORY AND DIAGNOSTIC FINDINGS

Samples taken from active genital lesions may be cultured or undergo NAATs or direct immunofluorescence (DIF) of viral antigens to confirm viral types. Cytopathologic testing is typically not recommended, although staining for HSV infection may be helpful. Viral culture is slow (≈ 5 days), expensive, and technique sensitive (i.e., the specimen must be placed in viral transport medium and refrigerated). Real-time PCR assays are highly accurate,



FIG 13.8 Recurrent herpes simplex virus infection of the foreskin. (From Habif TP, Campbell JI Jr, Chapman MS, et al: *Skin disease: diagnosis and treatment*, ed 2, St. Louis, Mosby, 2005.)

rapid, and less technique sensitive; can provide quantitative results; and, importantly, can be used to assess asymptomatic viral shedding. DIF is a rapid test but can only be used on rich fresh samples. Samples should be taken ideally within 24 hours of the initial clinical manifestations and taken from the base of the vesicular lesions.³²

Serology to detect HSV-1 or HSV-2 immunoglobulin (Ig) G is reliable to show past infection. HSV IgM serology is not reliable for a recent or early infection. Seroconversion can take several weeks to months in some cases, so repeat testing may be warranted if a patient tests seronegative at baseline.

MEDICAL MANAGEMENT

Evidence-based management strategies for genital herpes are related either to the treatment of patients diagnosed with an acute outbreak (either the primary or recurrent infections) or to the prevention of recurrent infections. All patients and their partners should receive counseling regarding the natural history of genital herpes, sexual and perinatal transmission, and ways to reduce transmission.

In those presenting with the first clinical episode of genital herpes, treatment includes oral antiviral therapy with acyclovir, famciclovir, or valacyclovir.^{33,34} All three are nucleoside analogue drugs that act as DNA chain terminators during virus replication in infected cells. Topical acyclovir therapy is substantially less effective than systemic drug administration, and its use is not recommended for genital herpes. Use of systemic antiviral drugs can shorten the duration, frequency, and symptoms of outbreaks and can reduce the frequency of asymptomatic

shedding and the risk of transmission.³⁵ However, antiviral agents do not eliminate the virus from the latent state, nor do they affect subsequent risk, frequency, or severity of recurrence after drug use is discontinued. However, antiviral drugs are effective when given preventatively (predominantly in those with a latent infection) or at least 1 day within the appearance of symptoms.³³ Daily suppressive antiviral therapy can be implemented for patients with frequent recurrences (more than five recurrences per year). Safety and efficacy have been documented among patients given daily therapy with acyclovir for as long as 6 years and among those given valacyclovir and famciclovir for 1 year. Suppressive therapy has not been associated with emergence of clinically significant acyclovir resistance among immunocompetent patients. Because the frequency of recurrence tends to diminish over time in many patients, current recommendations include discussing periodically the possibility of discontinuing suppressive therapy to reassess the need for continued therapy.

Acyclovir, famciclovir, and valacyclovir have been assigned pregnancy category C, B, and B, respectively, by the FDA. Accordingly, famciclovir and valacyclovir are considered relatively safe to administer to pregnant women.

Current treatment recommendations by the CDC³⁶ (Box 13.3) are directed toward primary, recurrent, and suppressive genital herpes therapy. These protocols may also be used for oral infections. IV antiviral agents (acyclovir, cidofovir, and foscarnet) are reserved for severe or complicated infections and may be required for immune-suppressed patients.

Despite extensive research, there is currently no effective vaccine for HSV infection.³⁷

DENTAL CONSIDERATIONS AND ORAL MANIFESTATIONS

Genital herpes may rarely be transmitted from genital sites to the oral cavity (Fig. 13.9).

Herpes simplex virus–induced lesions involving the oral and perioral tissues, irrespective of cause or viral subtype, are infectious during the papular, vesicular, and ulcerative stages, and elective dental treatment should be delayed until the herpetic lesion has completely healed. Dental manipulation during these infectious stages poses risks of (1) inoculation to a new site on the patient, (2) infection to the dental care worker, and (3) aerosol or droplet inoculation of the conjunctivae of the patient or of dental personnel. After the lesion has crusted, it can be considered as relatively noninfectious. Antiviral agents may be required to prevent recurrence after dental treatment has been provided.³⁸ Management of oral HSV infections is covered in Appendix C.

A problem of particular concern to dentists is herpetic infection of the fingers or nail beds contracted by dermal contact with a herpetic lesion of the lip or oral cavity of a patient. The infection is called a herpetic whitlow or a

BOX 13.3 Regimens Recommended by the Centers for Disease Control and Prevention for the Treatment of Genital Herpes

Primary Episode of Genital Herpes* (Moderate- to High-Quality Evidence^{33,34})

Acyclovir 400 mg orally three times a day for 7–10 days, or
Acyclovir 200 mg orally five times a day for 7–10 days, or
Famciclovir 250 mg orally three times a day for 7–10 days, or
Valacyclovir 1 g orally twice a day for 7–10 days

Recurrent Infection

Acyclovir 400 mg orally three times a day for 5 days, or
Acyclovir 200 mg orally five times a day for 5 days, or
Acyclovir 800 mg orally twice a day for 5 days, or
Famciclovir 125 mg orally twice a day for 5 days, or
Valacyclovir 500 mg orally twice a day for 3 to 5 days, or
Valacyclovir 1000 mg orally once a day for 5 days

Daily Suppressive Therapy (Moderate- to High-Quality Evidence³³)

Acyclovir 400 mg twice daily, or
Famciclovir 250 mg orally twice a day, or
Valacyclovir 500 mg orally once a day, or
Valacyclovir 1000 mg orally once a day

*Note: Treatment may be extended if healing is incomplete after 10 days of therapy. Higher dosages of antivirals are indicated for patients who have more than 10 recurrences per year and for immunocompromised patients.

herpetic paronychia (Fig. 13.10). It is serious, debilitating, and recurrent.³⁹ Also, asymptomatic HSV shedding at oral or nonoral sites can trigger erythema multiforme, a mucocutaneous eruption characterized by “target” papules and ulcers that result from an immune response to the virus.

INFECTIOUS MONONUCLEOSIS

Although not classically defined as an STD, infectious mononucleosis is discussed in this chapter because transmission occurs through intimate personal contact. In more than 90% of cases, IM is caused by a primary EBV infection (the remaining approximately 10% of cases caused by other organisms, including CMV, HHV-6, HIV, adenovirus, and toxoplasmosis). Children, adolescents, and young adults are most commonly affected, and transmission of the virus occurs primarily by way of the oropharyngeal route during close personal contact (i.e., intimate kissing). Infectious mononucleosis produces a clinical triad of fever, sore throat, and lymphadenopathy and is associated with lymphocytosis.

EPIDEMIOLOGY

More than 90% of adults worldwide have been infected with EBV.⁴⁰ EBV seroprevalence increases during childhood,



FIG 13.9 Primary herpes simplex type 2 occurring in the oral cavity documented by laboratory testing. (From Sapp JP, Eversole LS, Wysocki GP: *Contemporary oral and maxillofacial pathology*, ed 2, St. Louis, Mosby, 2004.)



FIG 13.10 Herpetic whitlow. (From Habib TP, Campbell JI Jr, Chapman MS, et al: *Skin disease: diagnosis and treatment*, ed 2, St. Louis, Mosby, 2005.)

with the highest rates in non-Hispanic blacks aged 15 to 19 years ($\approx 78\%$).⁴¹ No gender predilection has been noted. Having numerous sexual partners increases the risk for acquisition of EBV. Only about 25% of teenagers who are infected with EBV develop infectious mononucleosis.

ETIOPATHOGENESIS

Epstein-Barr virus is a B-lymphotropic herpesvirus that is transmitted primarily after exposure to oropharyngeal

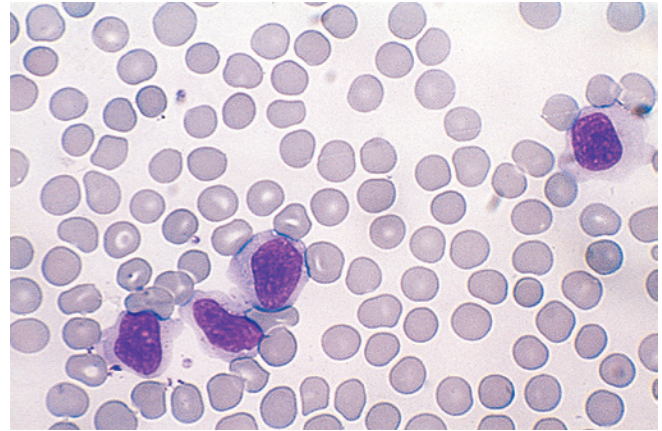

FIG 13.11 Atypical lymphocytes in infectious mononucleosis. (From Kumar V, Abbas A, Fausto N: *Robbins & Cotran's pathologic basis of disease*, ed 7, Philadelphia, 2005, Saunders.)

secretions, predominantly by kissing. Infrequently, it is transmitted through shared infected drinks, eating utensils, or infected blood products. The incubation time is approximately 6 weeks. A prodromal period of 3 to 5 days precedes the clinical phase, which typically lasts 7 to 20 days. During the prodromal phase, the virus infects oropharyngeal epithelial cells and spreads to B lymphocytes in the tonsillar crypts. Infected B lymphocytes circulate through the reticuloendothelial system, triggering a marked CD8⁺ T-lymphocytic response (Fig. 13.11).⁴² The combination of reactive lymphocytes, the cytokines they produce, and the B cell-produced (heterophile) antibodies directed against EBV antigens contributes to the clinical manifestation of the acute infection. After the acute infection, the virus remains latent in B lymphocytes for the life of the host. About 40% of asymptomatic herpesvirus-seropositive adults carry EBV in their saliva on any given day.⁴³

CLINICAL PRESENTATION

Infectious mononucleosis usually is asymptomatic when found in children; however, when young adults are affected, about 75% are symptomatic. A meta-analysis of clinical features reported the most common presentations include any lymphadenopathy (predominantly cervical), sore throat, and malaise and fatigue.⁴⁴ Less common manifestations include palatal petechial hemorrhage; posterior cervical, axillary, or inguinal lymphadenopathy; pharyngeal or tonsillar exudate; and cutaneous rash. Other signs and symptoms include fever, headache, decreased appetite, nausea and vomiting, myalgias (body aches), arthralgias, splenomegaly, hepatomegaly, and jaundice. Symptoms typically dissipate within 3 weeks of onset.

Complications are rare (<1%) but can include splenic rupture (particularly in patients who play sports during the infection), airway obstruction caused by pharyngitis,

meningoencephalitis, hemolytic anemia, and thrombocytopenia. Infectious mononucleosis and EBV are unlikely to be the underlying cause for chronic fatigue syndrome, but EBV and a history of infectious mononucleosis are strong risk factors for the development of multiple sclerosis, EBV-associated lymphomas, and nasopharyngeal carcinoma.⁴⁵

LABORATORY AND DIAGNOSTIC FINDINGS

The diagnosis of infectious mononucleosis cannot be made by clinical examination alone, and laboratory testing is necessary for confirmation. A white blood cell count demonstrating lymphocytosis (>50%) with blood smears revealing more than 10% atypical “reactive” lymphocytes is highly predictive (see Fig. 13.11). Other laboratory testing includes the nonspecific heterophile antibody test, specific enzyme immunoassay antibody tests, and PCR. Heterophile antibodies are IgM antibodies that bind (agglutinate) to erythrocytes from nonhuman species such as sheep and horses.⁴⁶ This process forms the basis for the inexpensive rapid latex agglutination test (Monospot test). This test can lead to false-negative results (up to 25%, particularly during early infection), and in 2014, the CDC advised against its use, favoring the highly accurate, albeit more expensive, antibody tests to the viral capsid antigen (VCA-IgM and VCA-IgG) and EBV nuclear antigen (EBNA). A positive VCA-IgM result is commensurate with the primary infection; positive results for VCA-IgG and EBNA show a history of past infection. PCR testing can also be used for detecting primary infection.⁴⁷ After EBV-associated mononucleosis has been diagnosed, EBV copy numbers in the blood can be used to monitor the severity and progression of the infection, particularly in an immunocompromised patient.⁴⁸

MEDICAL MANAGEMENT

Infectious mononucleosis is largely the result of the immune response to EBV, and there are no pharmacotherapies indicated for the disease. As such, treatment is tailored to symptoms and consists of bedrest, fluids, acetaminophen or nonsteroidal antiinflammatory agents for pain control, and gargling and irrigation with saline solution or lidocaine to relieve sore throat symptoms. Antiviral drugs such as acyclovir can inhibit EBV replication, but they are not indicated for acute infectious mononucleosis except in severe cases or in immunocompromised patients. Systemic corticosteroids are not recommended unless there is evidence of airway obstruction.⁴⁹ Vigorous activity is to be avoided to reduce the risk of splenic rupture. About 20% of patients with symptomatic infectious mononucleosis have concurrent β -hemolytic streptococcal pharyngotonsillitis and should be treated with penicillin VK if they are not allergic to penicillin; they should not be treated with ampicillin, which can cause a hypersensitivity reaction

and skin rash. Most patients feel better and return to normal activities within 1 month.

Despite active research, there are currently no vaccines to prevent infectious mononucleosis.⁵⁰

DENTAL CONSIDERATIONS

Patients with infectious mononucleosis may come to a dentist because of oral signs and symptoms and should be referred to a physician for evaluation and treatment. Routine dental treatment should be delayed for about 4 weeks until the patient has recovered.

ORAL MANIFESTATIONS

Patients (particularly adolescents) presenting with palatal petechiae, enlarged tonsils, pharyngitis with tonsillar exudate, and with cervical lymphadenopathy should raise suspicion of infectious mononucleosis. Patients with a history of infectious mononucleosis may be at risk for developing EBV-associated Hodgkin and non-Hodgkin lymphomas. These lymphomas may manifest as persistent cervical lymphadenopathy or oral cavity lesions.

GENITAL WARTS AND HUMAN PAPILLOMAVIRUS INFECTIONS

Human papillomaviruses are small, double-stranded, nonenveloped DNA viruses that infect and replicate in mucosal and cutaneous sites. More than 120 genotypes of HPV have been identified, and more than 40 types are known to be sexually transmitted and to affect the anogenital epithelium.⁵¹ Each HPV subtype exhibits preferential anatomic sites of infection and a propensity for altering epithelial growth and replication. The spectrum of disease that is induced is dependent on the type of HPV infection, location, and immune response. Subtypes of HPV have been classified as “high-risk” or “low-risk” types. Low-risk HPVs (>90% of subtypes are HPV-6 and -11) cause benign lesions (involving genital and other nongenital skin and mucosal sites), and high-risk HPV types (predominantly HPV-16 and -18) are strongly associated with intraepithelial lesions and carcinoma of the cervix, vagina, and anus.⁵² HPV-16 is also strongly associated with oropharyngeal cancer (base of tongue and tonsils). [Box 13.4](#) lists HPV-associated lesions and conditions.

EPIDEMIOLOGY

Globally, genital warts are the most common STDs. The global annual incidence of genital warts is estimated to fall within a range from 100 to 200 per 100,000, and the prevalence varies from approximately 0.13% to 0.20% in studies of populations seeking medical care and up to 1% to 5% in studies of general populations undergoing

BOX 13.4 Human Papillomavirus–Associated Lesions and Common Human Papillomavirus Genotypes

Nongenital Benign Lesions Involving the Skin

Common warts (*verrucae vulgaris*)^{1,2,4,7}

Flat plane warts^{3,9}

Plantar warts^{1,2,4,6,3}

Nongenital Benign Lesions Involving Mucosae

Oral papillomata^{6,10}

Focal epithelial hyperplasia (Heck's disease)^{13,32}

Recurrent laryngeal papillomatosis^{6,9}

Oral condylomata^{6,9}

Florid oral papillomatosis (HIV-infected patients)^{6,7,9,18,32}

Genital Benign Lesions

Anogenital warts (*condyloma acuminatum*)^{6,9}

Malignant and Potentially Malignant Disorders

Anal dysplasia and squamous cell carcinoma^{18,20}

Cervical intraepithelial neoplasia and squamous cell carcinoma^{18,20,31,33,35,39,45,52,56}

Penile squamous cell carcinoma^{18,20}

Oropharyngeal squamous cell carcinoma^{18,20}

Vulvar squamous cell carcinoma^{18,20}

genital examinations.⁵³ In the United States, an estimated 80 million people have an active genital HPV infection, and more than 14 million new infections occur annually.³ More than 90% of these infections resolve over time, and the remainder become symptomatic, manifesting as either genital warts or as premalignant or malignant disease (i.e., in those harboring high-risk genotypes infections). At least 50% of sexually active adults will acquire an HPV infection during their lifetime. Genital warts are common in both sexes, and the highest rates of infection occur between the ages of 19 and 26 years. By age 50 years, more than 80% of women will have acquired genital HPV infection. The infection is more common among African American women than white women. The lifetime number of sexual partners is the most important risk factor for the development of genital warts.⁵⁴ Based on data from 2008 to 2012, there are approximately 31,000 HPV-associated cancers diagnosed annually in the United States.⁵⁵

ETIOPATHOGENESIS

Genital HPV can be transmitted by direct contact during sexual contact (i.e., penetrative: vaginal or anal, or nonpenetrative: oral–genital, genital–genital, or manual–genital). Fetal infection is rare but can lead to respiratory papillomatosis. The virus enters the epithelium or epidermis through microtears and infects the basal cell layer. When

the virus is intracellular, it increases the turnover of infected cells. Nononcogenic subtypes, such as HPV-6 and -11 have a strong tendency to induce epithelial hyperplasia, leading to condylomata. Some infections remain episomally in a latent state. Genital lesions (*condyloma acuminatum*) usually appear after an incubation period of 3 weeks to 8 months. There are at least 13 different oncogenic genotypes, of which HPV-16 and -18 are the most commonly detected in human cancers. All oncogenic genotypes have a propensity to induce dysplasia and malignancy, although it typically takes years to decades for malignant transformation to occur.

CLINICAL PRESENTATION

Anogenital warts (*condylomata*) are predominantly external, although they may be found intraanally, intravaginally, or involving the cervix and urethral meatus. Externally, they have a variable clinical appearance, ranging from small multiple confluent sessile papules (<1 mm) to grossly exophytic papillary or warty cauliflower-like lesions measuring up to several centimeters in diameter. In men, these growths may be found on the penis, scrotum, pubic region, and anal and rectal areas. In women, genital warts are commonly found on moist areas on the labia minora and vaginal opening (Fig. 13.12, A). The borders are raised and rounded. The color varies from pink to dusky gray. Most condylomata are asymptomatic; however, patients may report itching, irritation, pain, or bleeding as a result of manipulation or trauma.

LABORATORY AND DIAGNOSTIC FINDINGS

Human papillomavirus does not grow in cell culture, and serologic tests are not routinely performed. Therefore, if the clinical diagnosis *condyloma acuminatum* is uncertain, lesions should be biopsied and examined microscopically. The microscopic appearance consists of a sessile base, with raised epithelial borders, a thick spinous spinosum layer (acanthosis), hyperkeratosis, and often with the presence of koilocytes. If needed, the identification of HPV genotype is typically achieved with the use of commercial DNA and RNA in situ hybridization kits to detect HPV. Some kits can screen for low- versus high-risk HPV genotypes, and others can identify specific genotypes (Fig. 13.12, D). Alternative diagnostics include PCR and immunohistochemistry using anti-HPV antibodies.⁵⁶

MEDICAL MANAGEMENT

As with all STDs, treatment should include the patient's sexual partner(s) to avoid reinfection and protective activities (i.e., abstinence, use of condoms) to reduce transmission. Without treatment, lesions may enlarge and spread, although spontaneous regression can occur.

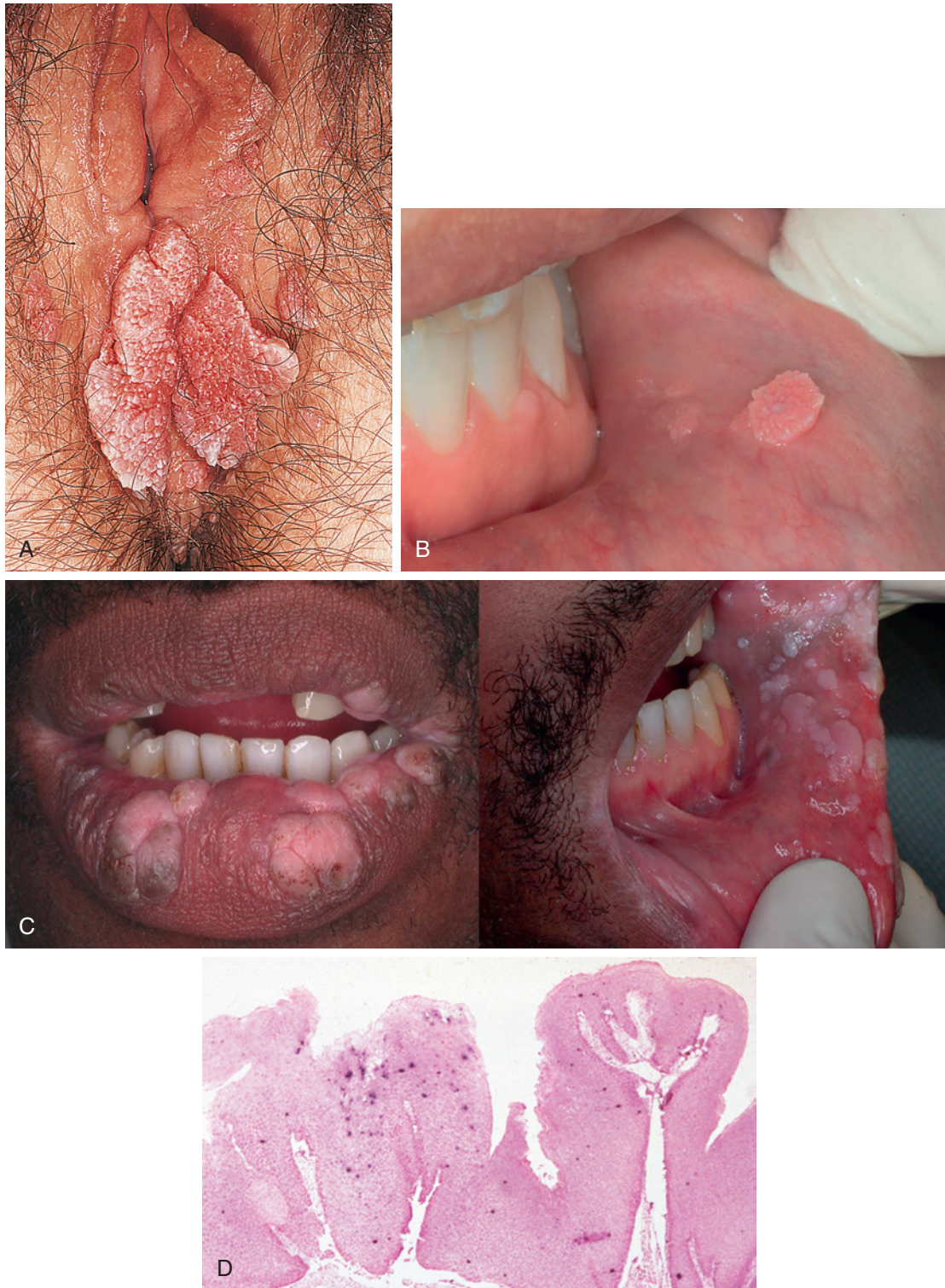

FIG 13.12 Human papillomavirus (HPV) infections. **A**, Large, cauliflower-like wart of the vagina. **B**, Flat-topped papillary oral condylomata of the labial mucosa. **C**, Multiple oral warts in an HIV-infected homosexual man. **D**, In situ hybridization showing HPV DNA as indicated by dark purple stains in the epithelium of a condyloma acuminatum. (A, From Habif TP, Campbell JI Jr, Chapman MS, et al: *Skin disease: diagnosis and treatment*, ed 2, St. Louis, Mosby, 2005.)

Genital Warts

There is a strong evidence base for the management of genital warts that supports the use of a number of regimens that lead to clearance of warts, reduce recurrence, and prevent further transmission.⁵⁷ These include surgical and ablative techniques or the administration of antiproliferative or immunomodulatory agents. Ablative techniques include scalpel excision; electrosurgery; laser removal (i.e., vaporization with a CO₂ laser); cryotherapy; photodynamic therapy; and chemical destruction with local application of trichloroacetic acid, bichloroacetic acid, or potassium hydroxide. Nondestructive topical agents include podophyllotoxin, podophyllin, imiquimod, sinecatechins (e.g., Polyphenon E), cidofovir, and 5-fluorouracil.⁵⁸ Other agents include systemic retinoids and interferon, which may be used topically, intralesionally, or systemically. The CDC-recommended treatments, along with grading of evidence, are provided in [Box 13.5](#).⁵⁹

Cancer

The management of lesions diagnosed with low- or high-grade anogenital squamous intraepithelial disease or squamous cell carcinoma generally involves surgery with or without radiation therapy, chemotherapy, or targeted therapy. Readers are referred to the American Cancer Society's website for additional information.

A major advance occurred in 2006 with the introduction of the quadrivalent HPV vaccine (Gardasil), which covers HPV genotypes 6, 11, 16, and 18. This vaccine is 95% to 100% effective in preventing infection and has been approved for use in girls and women aged 9 to 26 years and boys at 11 or 12 years (labeled for genital warts) and is administered in a three-shot regimen over a 6-month period. Recently, a new nonavalent HPV vaccine (Gardasil 9) has been introduced that covers five additional oncogenic genotypes (31, 33, 45, 52, and 58). Within 6 years of the introduction of the quadrivalent vaccine, the prevalence of HPV-6, -11, -16, and -18 infection in young women has shown a significant reduction (a 64% decrease in the 14- to 19-year age group and a 34% decrease in the 20- to 24-year age group).⁶⁰

ORAL MANIFESTATIONS AND DENTAL CONSIDERATIONS

Oral condylomata acuminatum commonly occur as solitary or multiple lesions on the ventral tongue, gingivae, labial mucosae, and palate ([Fig. 13.12, B](#)). Oral warts in HIV-infected patients, predominantly in the MSM population, may present as solitary lesions or as clusters of multiple lesions that may be florid in their presentation and that can be unesthetic ([Fig. 13.12, C](#)).⁶¹ A number of different HPV genotypes may be detected in these lesions, some

BOX 13.5 Regimens Recommended by the Centers for Disease Control and Prevention for the Treatment of Anogenital Warts

External Anogenital Warts (i.e., Penis, Groin, Scrotum, Vulva, Perineum, External Anus, and Perianus*)

Patient Applied

Imiquimod 3.75% or 5% cream[†] (very low-⁶⁵ to high-⁵⁷ quality evidence in HIV-negative patients, low in HIV-positive patients⁵⁷), or
Podofilox 0.5% solution or gel (high-quality evidence in HIV-negative patients⁵⁷), or
Sinecatechins 15% ointment[†]

Provider Administered

Cryotherapy with liquid nitrogen or cryoprobe, or
Surgical removal:

- Tangential scissor excision, tangential shave excision, curettage (moderate quality evidence⁵⁷) or laser (low evidence vs surgical excision⁵⁷), or
- Electrosurgery (high-quality evidence⁵⁷), or

TCA or CA 80%–90% solution (moderate-quality evidence⁵⁷)

Urethral Meatus Warts

Cryotherapy with liquid nitrogen, or
Surgical removal

Vaginal Warts

Cryotherapy with liquid nitrogen, or
Surgical removal, or
TCA or BCA 80%–90% solution

Note: The use of a cryoprobe in the vagina is not recommended because of the risk for vaginal perforation and fistula formation.

Cervical Warts

Cryotherapy with liquid nitrogen, or
Surgical removal, or
TCA or BCA 80%–90% solution

Note: Management of cervical warts should include consultation with a specialist. For women who have exophytic cervical warts, a biopsy evaluation to exclude high-grade SIL must be performed before treatment is initiated.

Intra-anal Warts

Cryotherapy with liquid nitrogen, or
Surgical removal, or
TCA or BCA 80%–90% solution

Note: Management of intraanal warts should include consultation with a specialist.

*Many persons with external anal warts also have intraanal warts. Thus, persons with external anal warts might benefit from an inspection of the anal canal by digital examination, standard anoscopy, or high-resolution anoscopy.

[†]Might weaken condoms and vaginal diaphragms.

BCA, Bichloroacetic acid; SIL, squamous intraepithelial lesion; TCA, trichloroacetic acid.

of which are high risk.⁶² Such lesions range in color (pink to white), surface topography (flat surfaced to papillary), and size (small 1–2 mm and confluent to large [>1 cm in diameter] and grossly exophytic).

Not all oral warts are transmitted sexually, and when detected during a routine examination, oral health care providers should elicit a careful history to assess the likely mode of transmission. The identification of condylomata in children raises the suspicion of sexual abuse, particularly when autoinoculation by hand-to-genital contact, non-sexual contact, or maternal–fetal transmission has been ruled out. Failure to report signs of an STD to state health officials is a legal offense in some states.

Oral warts typically present little risk for transmission to the oral health care team. Solitary oral warts may be surgically excised and submitted for histopathology. Management of florid oral warts is challenging, and there is no evidence-based treatment. Lesions can be surgically excised or removed by electrocautery or laser. Clearance of warts with the use of topical, intralesional, or systemic agents such as podophyllin, imiquimod, cimetidine, interferon, or cidofovir has been reported, although adverse effects are possible. Strict infection control procedures and high-speed evacuation should be used during laser therapy to avoid cross-contamination of surfaces and inhalation of the virion-laden plume.⁶³

SUMMARY

The dental management of patients with STDs begins with identification. Because they are potentially infectious, the obvious goal is to identify all individuals who have active disease. Unfortunately, this is not possible in every case because some patients will not provide a history or may not demonstrate significant signs or symptoms suggestive of disease. The inability of clinicians to identify potentially infectious patients applies to other diseases as well, such as HIV infection and viral hepatitis. Therefore, it is necessary for all patients to be managed as though they were infectious. The U.S. Public Health Service, through the CDC, has published recommendations for standard precautions to be followed for preventing cross-infection in dentistry (see [Appendix B](#)).⁶⁴ Strict adherence to these recommendations will, for all practical purposes, eliminate the danger of disease transmission between the dental team and patients. New cases of syphilis, gonorrhea, and acquired immunodeficiency syndrome (AIDS) should be reported to the local or state health department. Reasonable suspicion of sexual abuse in children, such as the identification of oral condylomata, should also be reported.

REFERENCES

- Newman L, Rowley J, Vander Hoorn S, et al. Global estimates of the prevalence and incidence of four curable sexually transmitted infections in 2012 based on systematic review and global reporting. *PLoS ONE*. 2015;10:e0143304.
- Sexually Transmitted Disease Surveillance 2014*. Atlanta: Centers for Disease Control and Prevention; 2015.
- Satterwhite CL, Torrone E, Meites E, et al. Sexually transmitted infections among US women and men: prevalence and incidence estimates, 2008. *Sex Transm Dis*. 2013;40:187-193.
- Owusu-Edusei K Jr, Chesson HW, Gift TL, et al. The estimated direct medical cost of selected sexually transmitted infections in the United States, 2008. *Sex Transm Dis*. 2013;40:197-201.
- Fleming DT, Wasserheit JN. From epidemiological synergy to public health policy and practice: the contribution of other sexually transmitted diseases to sexual transmission of HIV infection. *Sex Transm Infect*. 1999;75:3-17.
- Freeman EE, Weiss HA, Glynn JR, et al. Herpes simplex virus 2 infection increases HIV acquisition in men and women: systematic review and meta-analysis of longitudinal studies. *AIDS*. 2006;20:73-83.
- Unemo M, Del Rio C, Shafer WM. Antimicrobial resistance expressed by *Neisseria gonorrhoeae*: a major global public health problem in the 21st century. *Microbiol Spectr*. 2016;4(3):213-237.
- Balmelli C, Gunthard HF. Gonococcal tonsillar infection—a case report and literature review. *Infection*. 2003;31:362-365.
- Little JW. Gonorrhea: update. *Oral Surg Oral Med Oral Pathol Oral Radiol Endod*. 2006;101:137-143.
- Recommendations for the laboratory-based detection of *Chlamydia trachomatis* and *Neisseria gonorrhoeae*—2014. *MMWR Recomm Rep*. 2014;63:1-19.
- Workowski KA, Bolan GA. Sexually transmitted diseases treatment guidelines, 2015. *MMWR Recomm Rep*. 2015;64:1-137.
- Yu X, Zheng H. Syphilitic chancre of the lips transmitted by kissing: a case report and review of the literature. *Medicine (Baltimore)*. 2016;95:e3303.
- Tucker JD, Shah S, Jarell AD, et al. Lues maligna in early HIV infection case report and review of the literature. *Sex Transm Dis*. 2009;36:512-514.
- Gomez GB, Kamb ML, Newman LM, et al. Untreated maternal syphilis and adverse outcomes of pregnancy: a systematic review and meta-analysis. *Bull World Health Organ*. 2013;91:217-226.
- De Santis M, De Luca C, Mappa I, et al. Syphilis infection during pregnancy: fetal risks and clinical management. *Infect Dis Obstet Gynecol*. 2012;2012:430585.
- Jafari Y, Peeling RW, Shivkumar S, et al. Are *Treponema pallidum* specific rapid and point-of-care tests for syphilis accurate enough for screening in resource limited settings? Evidence from a meta-analysis. *PLoS ONE*. 2013;8:e54695.
- Centers for Disease Control and Prevention. Sexually Transmitted Diseases. Treatment Guidelines, 2015: Syphilis. Vol 2016.
- Little JW. Syphilis: an update. *Oral Surg Oral Med Oral Pathol Oral Radiol Endod*. 2005;100:3-9.

19. Leuci S, Martina S, Adamo D, et al. Oral syphilis: a retrospective analysis of 12 cases and a review of the literature. *Oral Dis*. 2013;19:738-746.
20. Compilato D, Amato S, Campisi G. Resurgence of syphilis: a diagnosis based on unusual oral mucosa lesions. *Oral Surg Oral Med Oral Pathol Oral Radiol Endod*. 2009;108:e45-e49.
21. Czerninski R, Pikovski A, Meir K, et al. Oral syphilis lesions—a diagnostic approach and histologic characteristics of secondary stage. *Quintessence Int*. 2011;42:883-889.
22. Captline AM, White NS, Merkow LP, et al. Atrophic luetic glossitis. Report of a case. *Oral Surg Oral Med Oral Pathol*. 1970;30:192-195.
23. Nissanka-Jayasuriya EH, Odell EW, Phillips C. Dental stigmata of congenital syphilis: a historic review with present day relevance. *Head Neck Pathol*. 2016.
24. Michalek AM, Mahoney MC, McLaughlin CC, et al. Historical and contemporary correlates of syphilis and cancer. *Int J Epidemiol*. 1994;23:381-385.
25. Bernstein DI, Bellamy AR, Hook EW 3rd, et al. Epidemiology, clinical presentation, and antibody response to primary infection with herpes simplex virus type 1 and type 2 in young women. *Clin Infect Dis*. 2013;56:344-351.
26. Looker KJ, Garnett GP. A systematic review of the epidemiology and interaction of herpes simplex virus types 1 and 2. *Sex Transm Infect*. 2005;81:103-107.
27. Bradley H, Markowitz LE, Gibson T, et al. Seroprevalence of herpes simplex virus types 1 and 2—United States, 1999-2010. *J Infect Dis*. 2014;209:325-333.
28. Xu F, Sternberg MR, Kottiri BJ, et al. Trends in herpes simplex virus type 1 and type 2 seroprevalence in the United States. *JAMA*. 2006;296:964-973.
29. Brown ZA, Wald A, Morrow RA, et al. Effect of serologic status and cesarean delivery on transmission rates of herpes simplex virus from mother to infant. *JAMA*. 2003;289:203-209.
30. Langenberg AG, Corey L, Ashley RL, et al. A prospective study of new infections with herpes simplex virus type 1 and type 2. Chiron HSV Vaccine Study Group. *N Engl J Med*. 1999;341:1432-1438.
31. Engelberg R, Carrell D, Krantz E, et al. Natural history of genital herpes simplex virus type 1 infection. *Sex Transm Dis*. 2003;30:174-177.
32. Glinsek Biskup U, Ursic T, Petrovec M. Laboratory diagnosis and epidemiology of herpes simplex 1 and 2 genital infections. *Acta Dermatovenerol Alp Pannonica Adriat*. 2015;24:31-35.
33. Hollier LM, Straub H. Genital herpes. *BMJ Clin Evid*. 2011;4:pii 1603.
34. Hollier LM, Eppes C. Genital herpes: oral antiviral treatments. *BMJ Clin Evid* 2015;4:pii 1603.
35. Corey L, Wald A, Patel R, et al. Once-daily valacyclovir to reduce the risk of transmission of genital herpes. *N Engl J Med*. 2004;350:11-20.
36. Centers for Disease Control and Prevention. Sexually transmitted diseases treatment guidelines, 2015: Genital HSV Infection. Vol 2016.
37. McAllister SC, Schleiss MR. Prospects and perspectives for development of a vaccine against herpes simplex virus infections. *Expert Rev Vaccines*. 2014;13:1349-1360.
38. Miller CS, Cunningham LL, Lindroth JE, et al. The efficacy of valacyclovir in preventing recurrent herpes simplex virus infections associated with dental procedures. *JADA*. 2004;135:1311-1318.
39. Lewis MA. Herpes simplex virus: an occupational hazard in dentistry. *Int Dent J*. 2004;54:103-111.
40. Dunmire SK, Hogquist KA, Balfour HH. Infectious mononucleosis. *Curr Top Microbiol Immunol*. 2015;390:211-240.
41. Condon LM, Cederberg LE, Rabinovitch MD, et al. Age-specific prevalence of Epstein-Barr virus infection among Minnesota children: effects of race/ethnicity and family environment. *Clin Infect Dis*. 2014;59:501-508.
42. Balfour HH Jr, Dunmire SK, Hogquist KA. Infectious mononucleosis. *Clin Transl Immunology*. 2015;4:e33.
43. Miller CS, Avdiushko SA, Kryscio RJ, et al. Effect of prophylactic valacyclovir on the presence of human herpesvirus DNA in saliva of healthy individuals after dental treatment. *J Clin Microbiol*. 2005;43:2173-2180.
44. Ebell MH, Call M, Shinholser J, et al. Does this patient have infectious mononucleosis?: the rational clinical examination systematic review. *JAMA*. 2016;315:1502-1509.
45. Lennon P, Crotty M, Fenton JE. Infectious mononucleosis. *BMJ*. 2015;350:h1825.
46. Linderholm M, Boman J, Juto P, et al. Comparative evaluation of nine kits for rapid diagnosis of infectious mononucleosis and Epstein-Barr virus-specific serology. *J Clin Microbiol*. 1994;32:259-261.
47. Jiang SY, Yang JW, Shao JB, et al. Real-time polymerase chain reaction for diagnosing infectious mononucleosis in pediatric patients: a systematic review and meta-analysis. *J Med Virol*. 2016;88:871-876.
48. Balfour HH Jr, Holman CJ, Hokanson KM, et al. A prospective clinical study of Epstein-Barr virus and host interactions during acute infectious mononucleosis. *J Infect Dis*. 2005;192:1505-1512.
49. Rezk E, Nofal YH, Hamzeh A, et al. Steroids for symptom control in infectious mononucleosis. *Cochrane Database Syst Rev*. 2015;(11):CD004402.
50. Cohen JL. Epstein-barr virus vaccines. *Clin Transl Immunology*. 2015;4:e32.
51. Cubie HA. Diseases associated with human papillomavirus infection. *Virology*. 2013;445:21-34.
52. Rautava J, Syrjanen S. Human papillomavirus infections in the oral mucosa. *JADA*. 2011;142:905-914.
53. Patel H, Wagner M, Singhal P, et al. Systematic review of the incidence and prevalence of genital warts. *BMC Infect Dis*. 2013;13:39.
54. Munk C, Svare EI, Poll P, et al. History of genital warts in 10,838 women 20 to 29 years of age from the general population. Risk factors and association with Papanicolaou smear history. *Sex Transm Dis*. 1997;24:567-572.
55. Viens LJ, Henley SJ, Watson M, et al. Human papillomavirus-associated cancers - United States, 2008-2012. *MMWR Morb Mortal Wkly Rep*. 2016;65:661-666.

56. Wititsuwannakul J, Klump VR Jr, McNiff JM, et al. Detecting HPV in cutaneous lesions using anti-HPV antibody immunohistochemistry. *Am J Dermatopathol*. 2013;35:327-331.
57. W. Buck HJ. Warts (genital). *BMJ Clin Evid* 2010;pii 1602.
58. Fathi R, Tsoukas MM. Genital warts and other HPV infections: established and novel therapies. *Clin Dermatol*. 2014;32:299-306.
59. Centers for Disease Control and Prevention. Sexually Transmitted Diseases. Treatment Guidelines, 2015: Anogenital Warts.
60. Markowitz LE, Liu G, Hariri S, et al. Prevalence of HPV after introduction of the vaccination program in the United States. *Pediatrics*. 2016;137:e20151968.
61. Shiboski CH, Patton LL, Webster-Cyriaque JY, et al. The Oral HIV/AIDS Research Alliance: updated case definitions of oral disease endpoints. *J Oral Pathol Med*. 2009;38:481-488.
62. Syrjanen S. Human papillomavirus infection and its association with HIV. *Adv Dent Res*. 2011;23: 84-89.
63. Ilmarinen T, Auvinen E, Hiltunen-Back E, et al. Transmission of human papillomavirus DNA from patient to surgical masks, gloves and oral mucosa of medical personnel during treatment of laryngeal papillomas and genital warts. *Eur Arch Otorhinolaryngol*. 2012;269:2367-2371.
64. *Summary of Infection Prevention Practices in Dental Settings: Basic Expectations for Safe Care*. Atlanta, GA: US Department of Health and Human Services, Centers for Disease Control and Prevention, National Center for Chronic Disease Prevention and Health Promotion, Division of Oral Health; 2016.
65. Grillo-Ardila CF, Angel-Muller E, Salazar-Diaz LC, et al. Imiquimod for anogenital warts in non-immunocompromised adults. *Cochrane Database Syst Rev*. 2014;(11):CD010389.

Endocrine and Metabolic Disease

Diabetes Mellitus

DEFINITION

Diabetes mellitus is a group of metabolic diseases characterized by high blood glucose levels (hyperglycemia) and the inability to produce and/or use insulin. The disease is defined by abnormal blood glucose levels and utilization and is classified by the American Diabetes Association (ADA) into four general types (Box 14.1).¹ Each type is distinguished by the underlying mechanism, and each type demonstrates different levels of glycemia.

Diabetes is a chronic condition that may affect persons of all ages.^{1,2} Persistent hyperglycemia leads to metabolic and vascular complications.³⁻⁹ The vascular complications include premature macrovascular disease and serious microvascular disease. The metabolic component involves the elevation of blood glucose associated with alterations in lipid protein metabolism, resulting from a relative or absolute lack of insulin.³⁻⁵ Maintenance of tight glycemic control can prevent or retard the development of microvascular complications of diabetes, including oral complications.³⁻⁹ The vascular component includes an accelerated onset of nonspecific atherosclerosis and a specific microangiopathy that particularly affects the eyes and kidneys. Retinopathy and nephropathy are eventual complications in nearly every person with chronic diabetes. These complications result in serious and costly morbidity.³⁻⁹

Diabetes mellitus is of importance because:

- Dentists and hygienists will have many patients who have diabetes.
- Dentists and hygienists are in a position as members of a health care team to detect many persons who are not yet diagnosed or poorly controlled.
- Diabetes affects oral health, and oral health affects diabetes (it is bidirectional).
- Dentists and hygienists must be able to render care to patients already under medical management for their disease without endangering their well-being.

A crucial aspect of care of dental patients who have diabetes is determination of the level of disease severity and the level of glycemic control, as well as the presence of complications from diabetes, so that appropriate dental treatment can be provided. Essential to this determination is knowledge of the patient's blood glucose level at the time that dental treatment is provided.

COMPLICATIONS: Patients with diabetes undergoing dental treatment may not be diagnosed and may be at risk for complications such as unconsciousness, infection, bleeding, drug interactions, and side effects. These events could prove serious. The dentist must be able to identify these patients, assess risk based on history and clinical findings, and work closely with the managing physician to develop a dental management plan that will be effective and safe for the patient.

EPIDEMIOLOGY

More than 250 million persons worldwide have diabetes mellitus, and health officials estimate that this figure will exceed 300 million by 2020.¹⁻³ Nearly 30 million Americans, representing almost 9% of the entire population, are living with diabetes. Of these, approximately 25% have not been diagnosed. The ADA projects that by the year 2050, there will be approximately 87 million people with type 2 diabetes in the United States.^{1,2} The disease affects 15.9% of Native Americans and Alaska Natives, 13.2% of blacks, 12.8% of Hispanics, and 7.6% of whites. Diabetes mellitus accounts for about 79,000 deaths per year and is the seventh most common cause of death in the United States.³

Type 2 disease is the most prevalent type of diabetes mellitus.¹⁻⁵ Of patients with diabetes in the United States, more than 90% have type 2 disease. The incidence of type 2 diabetes increases with age and is primarily an adult disease. In contrast, type 1 diabetes occurs in 0.3% of Americans but is more than four times more prevalent than type 2 diabetes in persons younger than 20 years of age. Currently, there are about 26 million persons with type 2 disease (90%) and about 4 million with type 1 disease (10%).¹⁻⁵

The prevalence of diabetes mellitus has increased more than sixfold in the United States over the past 3 decades. The major reason for the dramatic increase is the obesity epidemic, especially in relation to type 2 diabetes.¹⁻⁴ Recent reports indicate that more than 60% of patients with type 2 diabetes are obese at the time of diagnosis, and more than two thirds of U.S. adults are overweight or obese.¹⁻⁴ Obesity is a major factor in the continual rise in the number of cases of diabetes in the United States.⁵⁻¹⁰ Other factors associated with the increasing prevalence of diabetes are the increasing population, increasing life

BOX 14.1 Current Classification of Diabetes

Type 1	<ul style="list-style-type: none"> • Beta cell destruction, usually leading to absolute insulin deficiency • Immune mediated: presence of islet cell or insulin antibodies that identify the autoimmune process, leading to beta cell destruction
Type 2	<ul style="list-style-type: none"> • Idiopathic: no evidence of autoimmunity • Insulin resistance with relative insulin deficiency or insulin secretory defect with insulin resistance
Other specific types	<ul style="list-style-type: none"> • Genetic defects of beta cell function or insulin action, diseases of exocrine pancreas, endocrinopathies, drug- or chemical-induced diabetes, infections, uncommon forms of immune-mediated diabetes, other genetic syndromes • Impaired fasting glucose (impaired glucose tolerance) • Abnormalities of fasting glucose (abnormal glucose tolerance)
Gestational	<ul style="list-style-type: none"> • Any degree of abnormal glucose tolerance during pregnancy diabetes

Data from American Diabetes Association: Standards of care—2011, *Diabetes Care* 34(suppl 1):S11-S61, 2011.

expectancy, and increasing number of affected persons who have offspring who will pass on the disease.⁴⁻¹¹

Etiology

Type 1 diabetes is primarily the result of pancreatic beta cell destruction and is characterized by insulin deficiency.⁴ *Type 2 diabetes* is characterized by insulin resistance and relative insulin deficiency.⁵ The broad category of *other specific types* (see Box 14.1) comprises more than 56 pathologic conditions that are attributed to genetic defects in beta cell function, as well as diseases or infections that cause diabetes. *Gestational diabetes* is abnormal glucose tolerance that first appears or is detected during pregnancy.¹² In addition, there are two types of *prediabetes*: impaired glucose tolerance and impaired fasting glucose.¹¹⁻¹³ Persons who have abnormal blood glucose levels that are not high enough to be classified as diabetes are assigned a diagnosis of prediabetes.¹¹⁻¹³ Fig. 14.1 illustrates the disorders of glycemia according to etiologic types.

Diabetes results from several pathogenic processes ranging from autoimmune destruction of pancreatic beta cells in type 1 diabetes to abnormalities that cause insulin resistance (type 2 diabetes). Type 1 diabetes is thought to be the result of genetic, autoimmune, and environmental factors.⁴⁻⁶ Fig. 14.2 illustrates the sequence of events that

Types	Stages	Hyperglycemia		
	Normoglycemia	Impaired Glucose Tolerance or Impaired Fasting Glucose	Not insulin requiring	Diabetes Mellitus Insulin requiring for control Insulin requiring for survival
Type 1		←—————→		
Type 2		←—————→		
Other Specific Types		←—————→		
Gestational Diabetes		←—————→		

FIG 14.1 Disorders of glycemia: etiologic types, stages, and requirements for insulin. The range of glycemic control is indicated by arrows. (From the American Diabetes Association: Diagnosis and classification of diabetes mellitus, *Diabetes Care* 34(suppl 1):S62-69, 2011.)

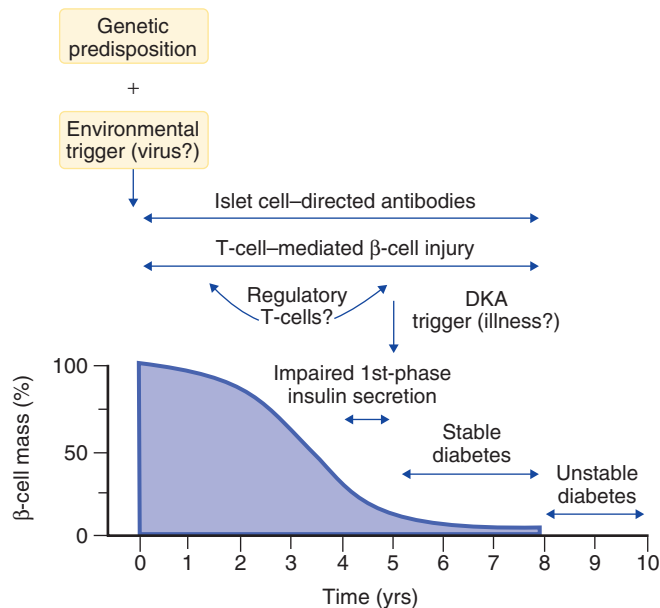

FIG 14.2 Summary of the sequence of events that leads to pancreatic beta cell loss and ultimately to the clinical evolution of type 1 diabetes. *DKA*, Diabetic ketoacidosis.

leads to pancreatic beta cell loss and ultimate diabetes and its progression over time.

The genetic component is demonstrated by data showing concordance rates of 30% to 40% among identical twins. human leukocyte antigen genes on chromosome 6 are linked to type 1 diabetes. Autoantibodies against beta cell constituents are present in 85% to 90% of patients with type 1 diabetes, and destruction of beta cells is modulated by T cells.⁴⁻⁶ Viral infections (mumps, rubella, and coxsackievirus infection) are suggested environmental factors that could trigger the autoimmune response associated with type 1 disease. About 10% to 15% of cases of type 1 diabetes are of unknown etiology (i.e., idiopathic).⁴⁻⁶

Type 2 diabetes has genetic, environmental, and aging components. A positive family history confers a lifetime risk of 38% to the offspring if one parent is affected and 60% if both parents are affected.^{5,6} Identical twin concordance rates approach 100%.^{5,6} The peroxisome proliferator-activated receptor γ (PPAR- γ) gene, which has a key role in regulation of adipogenic differentiation, is a candidate gene of type 2 diabetes; however, the disease is likely multigenic.^{5,6} Together the genetic and environmental factors contribute to defects in insulin receptor function, insulin receptor signal transduction, insulin secretion, glucose transport and phosphorylation, glycogen synthesis, glucose oxidation that contribute to insulin resistance, and accelerated endogenous glucose production. Obesity and lack of physical activity are the primary environmental factors involved in the pathogenesis of type 2 diabetes.^{5,6,11}

Other specific types of diabetes can be caused by specific gene defects, endocrine conditions such as primary

destruction of islet cells through inflammation, cancer, surgery, hyperpituitarism, or hyperthyroidism. Iatrogenic disease that occurs after steroid administration is a known cause.⁵

Gestational diabetes mellitus occurs in 5% to 7% of pregnant women during pregnancy. Obesity during pregnancy is a known risk factor for the condition. After childbirth, the mother's glycemic control usually returns to normal, but these women have an increased risk of developing diabetes within 5 to 10 years. Gestational diabetes enhances the risk for loss of the fetus and is associated with increased size of surviving fetuses. Insulin resistance is the suggested underlying etiopathogenic mechanism. A genetic basis may play a role; however, the underlying genetic factors have not yet been identified.^{5,6,12}

Pathophysiology and Complications

Persistent elevated blood glucose levels put persons at risk for diabetes.^{4,5} In fact, about 11% of people with prediabetes who were followed annually developed overt diabetes each year during the average 3 years of follow-up.^{11,13}

Glucose is rapidly taken up by the pancreatic beta cell and serves as the most important stimulus for insulin secretion.⁴⁻⁶ Insulin remains in circulation for only several minutes (half-life, 4–8 minutes); it then interacts with target tissues (e.g., muscle, liver, fat cells) and binds with cell surface insulin receptors. Secondary intracellular messengers are activated and interact with cellular effector systems, including enzymes and glucose transport proteins.⁴⁻⁶ Lack of insulin or deficient action of insulin leads to abnormalities in carbohydrate, fat, and protein metabolism (i.e., increased production of glucose from glycogen, fat, and protein). This combination of underutilization and overproduction of glucose attained through glycogenolysis and fat metabolism results in glucose accumulation in the tissue fluids and in blood⁴⁻⁶ (Fig. 14.3).

Hyperglycemia leads to glucose excretion in the urine, which results in increased urinary volume.^{3,4} The increase in fluid lost through urine may lead to dehydration and loss of electrolytes. With type 2 diabetes, prolonged hyperglycemia can lead to significant losses of fluid in the urine. When this type of severe dehydration occurs, urinary output drops, and a hyperosmolar nonketotic coma may result. This condition is seen most often in older adults with type 2 diabetes.¹³

Lack of glucose utilization by many cells of the body leads to cellular starvation. The patient often increases intake of food but in many cases still loses weight.^{4,7-9} If these events continue to progress, the person with type 1 diabetes develops metabolic acidosis. For a time, the body may be able to maintain the pH at nearly normal levels, but as the buffer system and respiratory and renal regulators fail to compensate, body fluids become more acidic (i.e., pH falls). Severe acidosis leads to coma and

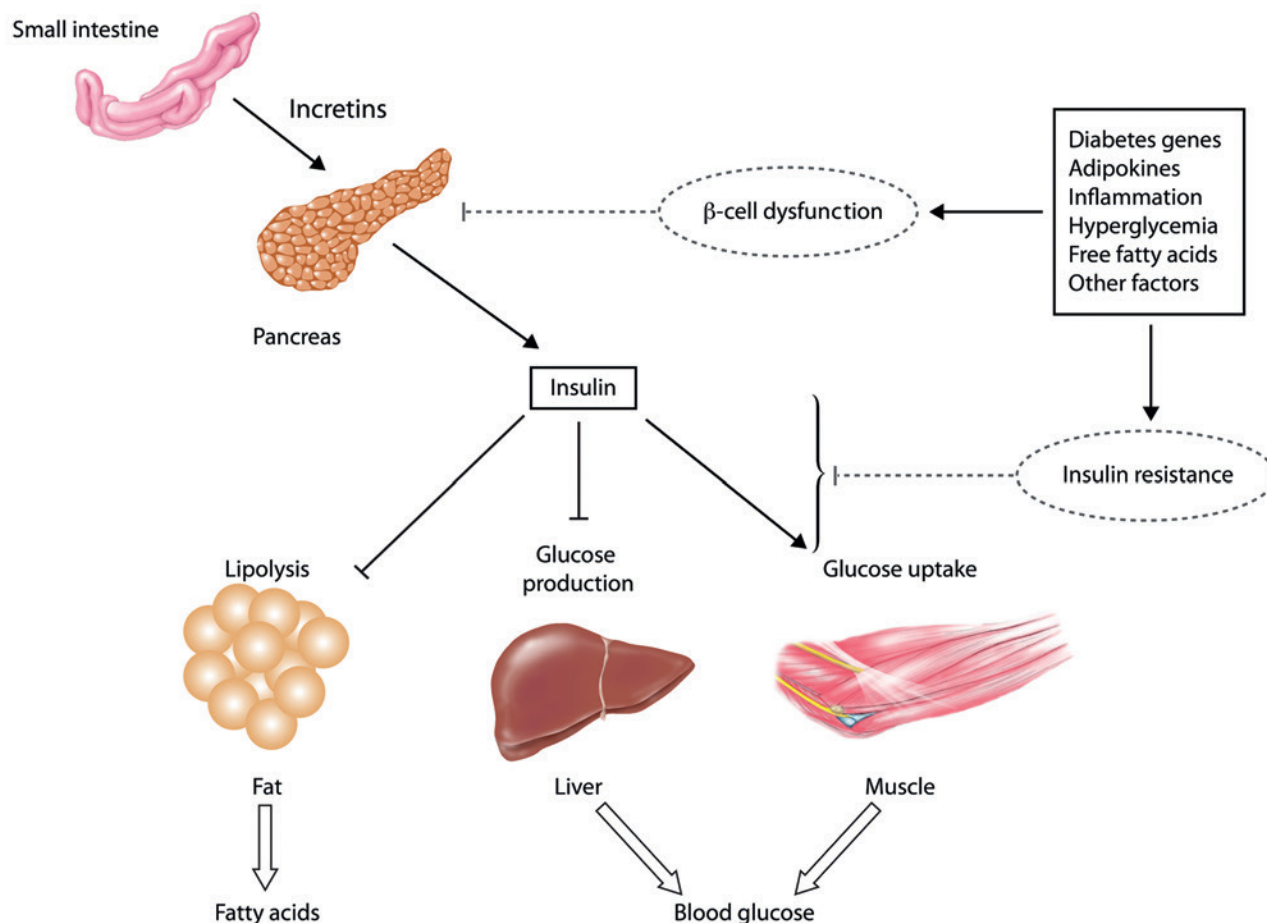

FIG 14.3 Pathophysiology of hyperglycemia and target tissues. (Courtesy of Mary Lous Cahal, University of Kentucky.)

death if it is not identified and treated. The primary manifestations of diabetes—hyperglycemia, ketoacidosis, and vascular wall disease—contribute to the inability of patients with uncontrolled diabetes to fight infection and to characteristic poor wound healing. Therefore, patients with uncontrolled diabetes are more susceptible to infection and infection spread, and healing of traumatic and surgical wounds is delayed.^{4,7-9,14}

Few deaths occur among patients diagnosed before the age of 30 years. However, in persons diagnosed before 40 years of age, fewer than half are still alive by age 55 years.^{4,7-9,15} In addition to decreasing life expectancy by at least 5 to 10 years, the complications of diabetes mellitus lead to significant signs and symptoms that impair the quality of life^{16,17} (Table 14.1).

Complications of diabetes are related to the level of hyperglycemia and pathologic changes that occur within the vascular system and the peripheral nervous system (Box 14.2).^{3,4} The vascular complications result from microangiopathy and atherosclerosis. The mechanisms by which hyperglycemia may lead to microvascular and atherosclerotic complications include increased accumulation of polyols through the aldose reductase pathway,

advanced glycation end products, and increased production of vascular endothelial cell growth factor (VEGF).^{3,4,17} Vessel changes include thickening of the intima, endothelial proliferation, lipid deposition, and accumulation of *para*-aminosalicylic acid–positive material. These changes can be seen throughout the body but have particular clinical importance when they occur within the retina and the small vessels of the kidney.¹⁷⁻¹⁹

Retinopathy occurs in all forms of diabetes. It consists of nonproliferative changes (microaneurysms, retinal hemorrhages, retinal edema, and retinal exudates) and proliferative changes (neovascularization, glial proliferation, and vitreoretinal traction) and is the leading cause of blindness in the United States.^{4,20} Proliferative retinopathy is most common among patients with type 1 diabetes; a much lower incidence is seen among those with type 2 diabetes. Cataracts occur at an earlier age and with greater frequency in those with type 1 diabetes.^{4,20} The typical cataract, senile cataract, is identified in 59% of persons with diabetes aged 35 to 55 years but in only 12% of those without the disease. Young people with diabetes are prone to the development of metabolic cataracts. The risk that a person with diabetes will become

TABLE 14.1 Expected Years of Additional Life in Persons With and Without Diabetes Compared With Given-Age Cohorts

Attained Age of Diabetic (yr)	Expected Years Additional Life in Patients Without Diabetes	Expected Years Additional Life in Patients With Diabetes	Years Lost Because of Diabetes
10	61.5	44.3	17.2
20	51.9	36.1	13.8
30	42.5	30.1	12.4
40	33.3	23.7	9.6

BOX 14.2 Complications of Diabetes Mellitus

- **Metabolic disturbances:** ketoacidosis and hyperosmolar nonketotic coma (type 2 diabetes)
- **Cardiovascular:** accelerated atherosclerosis (coronary heart disease¹); two thirds have high blood pressure; risk for stroke and heart disease death is two to four times higher among people with diabetes
- **Eyes:** retinopathy, cataracts; diabetes is leading cause of new cases of blindness among adults
- **Kidney:** diabetic nephropathy; diabetes is leading cause of renal failure
- **Extremities:** ulceration and gangrene of feet; diabetes is leading cause of non-accident-related leg and foot amputations
- **Diabetic neuropathy:** dysphagia, gastric distention, diarrhea, impotence, muscle weakness or cramps, numbness, tingling, deep burning pain
- **Early death:** diabetes is the seventh leading cause of death in the United States, most commonly caused by cardiovascular disease

Data from Centers for Disease Control and Prevention: *National diabetes fact sheet: national estimates and general information on diabetes and prediabetes in the United States, 2011*. Atlanta, GA, 2011, U.S. Department of Health and Human Services, Centers for Disease Control and Prevention.

blind is 20 times greater than that for the general population.^{4,20}

Individuals with diabetes are 25 times more likely to acquire end-stage renal disease (ESRD) than persons without diabetes.^{4,19} Diabetic nephropathy, caused by microangiopathy of the capillaries of the glomerulus, leads to ESRD in 30% to 40% of patients with type 1 diabetes (Fig. 14.4) and in 5% of patients with type 2 diabetes.^{4,19} However, because type 2 diabetes is much more common than type 1, the number of persons with renal failure is the same for the two types of diabetes. Renal failure is the leading cause of death in patients with type 1 diabetes. Of all patients who undergo dialysis, 37% have diabetes.^{4,19-23}

Macrovascular disease (atherosclerosis) occurs earlier and is more widespread and more severe in persons with diabetes.^{4,19-23} In patients with type 1 diabetes, atherosclerosis seems to develop independent of microvascular disease (microangiopathy). Hyperglycemia plays a role in the evolution of atherosclerotic plaques. Persons with uncontrolled diabetes have increased levels of low-density



FIG 14.4 Diabetic nephropathy: cross-section of a kidney. (Courtesy of Richard Estensen, MD, Minneapolis, Minnesota.)

lipoprotein (LDL) cholesterol and reduced levels of high-density lipoprotein (HDL) cholesterol. Attainment of normal glycemia often improves the LDL-to-HDL ratio.^{4,19-23}

A major determinant of the morbidity associated with poor glycemic control in diabetes is accelerated atherosclerosis.^{4,19,24,25} Atherosclerosis increases the risks of ulceration and gangrene of the feet (Fig. 14.5), hypertension, renal failure, coronary insufficiency, myocardial infarction (MI), and stroke. The most common cause of death in patients with type 2 diabetes is myocardial infarction.^{4,19,25} By age 60 years, one third of all persons with diabetes die of complications from coronary heart disease (CHD).^{19,23} Women with diabetes treated with insulin are at higher risk for CHD than non-insulin-treated women. This is not true for insulin-treated men.²³ Also, diabetics are at a two- to fourfold greater risk for MI and stroke than in persons without the disease, and a person with diabetes has less chance of surviving an MI than that typical for a person without diabetes.^{4,19-23}

In the extremities, diabetic neuropathy may lead to muscle weakness, muscle cramps, a deep burning pain,



FIG 14.5 Diabetic gangrene of the feet. (From Swartz MH: *Textbook of physical diagnosis: history and examination*, ed 6, Philadelphia, 2010, Saunders.)

tingling sensations, and numbness.^{19,25} In addition, tendon reflexes, two-point discrimination, and position sense may be lost. Some cases of oral paresthesia and burning tongue are caused by this complication.²⁶

Diabetic neuropathy also may involve the autonomic nervous system.²⁵ Esophageal dysfunction may cause dysphagia, stomach involvement may involve a loss of motility with gastric distention, and involvement of the small intestine may result in nocturnal diabetic diarrhea. Sexual impotence and bladder dysfunction also may occur. Diabetic neuropathy is common with type 1 and type 2 diabetes and may occur in more than 50% of patients. Neuropathy progresses over time in type 2 diabetes, and this increase may be greater in patients with hypoinsulinemia.^{19,25}

Diabetes is associated with skin rashes, deposits of fat in the skin (xanthoma diabetorum), decubitus ulcerations, poor wound healing, and gangrenous extremities.^{4,19,24} The relative risk that patients with diabetes will require amputation of an extremity because of diabetic complications is more than 40 times that of normal persons.¹⁹

The severity of complications of diabetes is largely dependent on the level of glycemic control.^{4,27-33} In one longitudinal study conducted over a period of more than 17 years, the investigators demonstrated that diabetic patients with good glycemic control (hemoglobin A_{1c} [HbA_{1c}] <7%) had 42% fewer systemic complications and 57% fewer deaths than those reported for patients with diabetes and poorly controlled hyperglycemia (HbA_{1c} levels above 8%).²⁷ Thus, a strong case can be made for early diagnosis and appropriate glycemic control to prevent or reduce progression of complications.

CLINICAL PRESENTATION

In patients with type 1 diabetes, the onset of symptoms is sudden and acute, often developing over days or weeks.^{4,14,19} Typically, the diagnosis is made in nonobese children or young adults younger than 40 years of age;

TABLE 14.2 Clinical Features of Type 1 and Type 2 Diabetes

Feature	Type 1	Type 2
Frequency,% of person with diabetes	5–10	90–95
Age at onset (yr)	15	40 and older
Body build	Normal or thin	Obese
Severity	Extreme	Mild
Insulin	Almost all	25%–30%
Plasma glucagons	High, suppressible	High, resistant
Oral hypoglycemic agents	Few respond	50% respond
Ketoacidosis	Common	Uncommon
Complications	90% in 20 years	Less common
Rate of clinical onset	Rapid	Slow
Stability	Unstable	Stable
Genetic locus	Chromosome 6	Chromosomes 2, 7, 12, 13, and 7
HLA and abnormal autoimmune reactions	Present	Not present
Insulin receptor defects	Usually not found	Often found

HLA, Human leukocyte antigen.

however, it may occur at any age. Signs and symptoms include polydipsia, polyuria, polyphagia, weight loss, loss of strength, marked irritability, recurrence of bed wetting, drowsiness, malaise, and blurred vision. Patients also may present with ketoacidosis, which if severe is accompanied by vomiting, abdominal pain, nausea, tachypnea, paralysis, and loss of consciousness.^{4,14,19}

Type 2 diabetes generally occurs after age 40 and more often affects obese individuals.^{5,11} The onset of symptoms in type 2 diabetes usually is insidious, and the cardinal manifestations and symptoms (polydipsia, polyuria, polyphagia, weight loss, and loss of strength) are less commonly seen.^{5,11,19} Signs and symptoms of type 1 and type 2 diabetes are summarized in [Table 14.2](#) and [Box 14.3](#).

Other signs and symptoms related to the complications of diabetes include skin lesions, cataracts, blindness, hypertension, chest pain, and anemia. The rapid onset of myopia in an adult is highly suggestive of diabetes mellitus.^{4,19}

Laboratory and Diagnostic Findings

The ADA recommends screening tests for diabetes mellitus for all persons who are 45 years of age and older and for persons with risk factors such as obesity, family history, belonging to an ethnic or minority group at risk for diabetes, the combination of low HDL cholesterol and high triglycerides, high blood pressure, or gestational diabetes and for women who have delivered large babies

BOX 14.3 Early Clinical Manifestations of Diabetes

Type 1

- **Cardinal signs and symptoms (common):** polydipsia, polyuria, polyphagia, weight loss, loss of strength
- **Other signs and symptoms:** recurrence of bed wetting, repeated skin infections, marked irritability, headache, drowsiness, malaise, dry mouth

Type 2

- **Cardinal signs and symptoms (much less common):** polydipsia, polyuria, polyphagia, weight loss, loss of strength
- **Frequent signs and symptoms:** slight weight loss or gain, gastrointestinal upset, nausea, urination at night, vulvar pruritus, blurred vision, decreased vision, paresthesias, dry flushed skin, loss of sensation, impotence, postural hypotension

(weighing >9 lb at birth) or who have had spontaneous abortions or stillbirths or have signs and symptoms of diabetes or its complications.^{31,32} For persons older than age 45 years, screening should occur routinely at 3-year intervals. Most screenings for diabetes involve evaluation for undiagnosed type 2 diabetes.^{31,32}

The diagnostic criteria for diabetes rely on the plasma glucose level, either (1) at a random sampling, (2) after fasting, or (3) after a 75-g glucose test (oral glucose tolerance test [OGTT]). Alternatively, the glycosylated hemoglobin test can be used. The ADA criteria for diabetes are presented in [Table 14.3](#).^{31,32}

The primary diagnostic criterion for *impaired fasting glucose* is fasting plasma glucose (FPG) levels of 100 to 125 mg/dL and for *impaired glucose tolerance* (IGT) is 140 to 199 mg/dL at 2 hours in the OGTT ([Table 14.4](#)). The primary diagnostic criterion for *diabetes* is FPG levels of greater than 126 mg/dL on more than one occasion.^{31,32}

Measurements of glucose are critical to the diagnosis and management of diabetes. Most glucose assays use enzymatic methods on either glucose dehydrogenase, glucose oxidase (coupled to ferricyanide), or glucose hexokinase.^{31,32} Of note, levels of blood glucose are influenced by the source of blood (venous vs capillary), the age of the patient, the nature of the diet, the physical activity level of the patient, and the method used to measure the amount of sugar present in the blood sample.^{31,32} Abnormalities in diet (e.g., diet poor in carbohydrate for several days) can lead to misdiagnoses. To minimize this possibility, the diet should contain at least 250 to 300 g of carbohydrate on each of the 3 days before testing. Patients whose blood glucose level is going to be assessed should not participate in excessive physical activity because exercise tends to lower blood glucose levels.^{31,32}

The OGTT reflects how quickly glucose is cleared from the blood, taking into consideration the rate of absorption, uptake by tissues, and excretion in urine.^{31,32} Glucose load is usually given as Glucola, which contains

TABLE 14.3 Diagnostic Criteria for Diabetes Mellitus*

1. FPG ≥ 126 mg/dL (≥ 7.0 mmol/L) on two occasions. Fasting is defined as no caloric intake for at least 8 hours. This fasting glucose value is consistently associated with the risk for retinopathy.
- or
2. Symptoms and signs of diabetes plus casual (random) plasma glucose concentration ≥ 200 mg/dL (11.1 mmol/L). *Casual* is defined as obtained at any time of day without regard to time since last meal. Many patients do not have obvious symptoms. The cardinal manifestations of diabetes include polyuria, polydipsia, and unexplained weight loss.
- or
3. 2-Hour postload glucose ≥ 200 mg/dL (≥ 11.1 mmol/L) during an OGTT. The test should be performed as described by the WHO using a glucose load containing the equivalent of 75 g of anhydrous glucose dissolved in water.*
- or
4. Glycosylated hemoglobin (by A_{1c} assay) $\geq 6.5\%$

*Oral glucose tolerance testing (OGTT) generally is not recommended in clinical practice.

FPG, Fasting plasma glucose; WHO, World Health Organization.

Data from Executive summary: standards of medical care in diabetes—2010: current criteria for the diagnosis of diabetes, *Diabetes Care* 33:S4-S10, 2010; Diagnosis and classification of diabetes mellitus, *Diabetes Care* 33(suppl 1):S62-S69, 2010; and International Expert Committee Report on the Role of the A1C Assay in the Diagnosis of Diabetes, *Diabetes Care* 32:1327-34, 2009.

75 g of glucose in a 7-oz bottle. Venous blood samples are drawn from the arm just before and most often at 2 hours after ingestion of the glucose. Urine samples also are collected at each interval. The most characteristic alterations seen in diabetes are an increased fasting blood glucose (≥ 126 mg/100 mL), an increased peak value (≥ 200 mg/100 mL), and a delayed return to normal in the 2-hour sample. Hypoglycemia may develop in persons with early, mild diabetes 3 to 5 hours after ingestion of glucose. For this reason, some physicians extend the glucose tolerance test period to 5 hours for some patients. Urine samples should not contain glucose at any point during the test.^{31,32}

The extent of glycosylation of hemoglobin A (a non-enzymatic addition of glucose) that results in formation of HbA_{1c} (i.e., glycated hemoglobin) in red blood cells is used to detect and assess the long-term level (and control) of hyperglycemia in patients with diabetes ([Table 14.5](#)).^{31,32} The laboratory test to determine HbA_{1c} is known as the A1C assay. This assay measures the amount of sugar attached to hemoglobin; levels increase in the presence of hyperglycemia. The A_{1c} reflects glucose levels in the blood over the preceding 3 months, which is the approximate life span of a red blood cell.^{4,24,25} In health, patients should have HbA_{1c} levels less than 6%. In well-controlled diabetes, the level should stay below 7%, without the occurrence of clinically significant hypoglycemia.^{4,24,25} It is standard

TABLE 14.4 Categories of Increased Risk for Diabetes (Prediabetes)

Fasting Plasma Glucose Level	2-Hour (75-g) Oral Glucose Tolerance Test*		
	<140 mg/dL	140–199 mg/dL	>200 mg/dL
<100 mg/dL	Normal	IGT	Diabetes mellitus
100–125 mg/dL	IFG	IGT and IFG	Diabetes mellitus

*Impaired fasting glucose (IFG): FPG levels 100–125 mg/dL; impaired glucose tolerance (IGT): 2-hour values in the OGTT of 140–199 mg/dL. Data from the American Diabetes Association: Diagnosis and classification of diabetes mellitus, *Diabetes Care* 34(suppl 1):S62-69, 2011.

TABLE 14.5 American Diabetes Association (ADA) and American College of Endocrinology (ACE): Targets for Glycemia Management

Parameter	Normal	ADA*	ACE
Premeal plasma glucose (mg/dL)	<100 (mean ≈90)	90–130	<110
Postprandial plasma glucose* (mg/dL)	<140	<180	<140
A _{1c}	4%–6%	<7% [†]	<6.5%

*Postprandial glucose measurements should be made 1 to 2 hours after the beginning of the meal, generally representing peak levels in patients with diabetes.

[†]The ADA further recommends: (1) goals should be individualized; (2) certain populations (children, pregnant women, and older adults) require special considerations; (3) less intensive goals may be indicated in patients with severe or frequent hypoglycemia; (4) as indicated by epidemiologic analysis, more stringent glycemic goals (i.e., a normal A_{1c} assay result, <6%) may further reduce complications at the cost of increased risk of hypoglycemia; and (5) postprandial glucose may be targeted if A_{1c} goals are not met despite reaching preprandial glucose goals.

Adapted from American Diabetes Association: Standards of medical care in diabetes, *Diabetes Care* 27:S15-S35, 2004 and American College of Endocrinologists: American College of Endocrinology consensus statement on guidelines for glycemic control, *Endocr Pract* 8(suppl 1):5-11, 2002.

practice to measure HbA_{1c} levels at least twice a year in patients whose treatment goals are being met (and who have stable glycemic control) and quarterly in patients whose treatment has changed or whose goals are not being met.^{4,24,25} Complications (including oral) from diabetes are accelerated in patients with elevated HbA_{1c}. Therefore, careful monitoring is particularly important for patients undergoing invasive procedures.^{24,26}

MEDICAL MANAGEMENT

Diabetes mellitus is not a curable disease; however, strict glycemic control established through regular monitoring reduces vascular and ocular complications.^{4,10,14,19,25} Hence, the guidelines published by the ADA target outcomes focused on glycemic control modified nutrient intake and weight reduction (as appropriate), blood pressure control, and a favorable lipid profile¹⁰ (Box 14.5 and Table 14.5).

Goals of therapy for type 1 or type 2 diabetes are to (1) eliminate symptoms related to hyperglycemia, (2)

reduce or eliminate the long-term microvascular and macrovascular complications of diabetes, and (3) allow the patient to achieve as normal a lifestyle as possible. To reach these goals, the physician should identify a target level of glycemic control for each patient, provide the patient with the educational and pharmacologic resources necessary to reach this level, and monitor and treat diabetes-related complications. Symptoms of diabetes usually resolve when the plasma glucose is below 11.1 mmol/L (<200 mg/dL), and thus most diabetes treatment focuses on achieving the second and third goals.¹⁹

The care of an individual with either type 1 or type 2 diabetes requires a multidisciplinary team. Central to the success of this team are the patient's participation, input, and enthusiasm, all of which are essential for optimal diabetes management. Members of the health care team include the primary care provider or the endocrinologist or diabetologist, a nutritionist, and a psychologist. In addition, when the complications of diabetes arise, subspecialists (including neurologists, nephrologists, vascular surgeons, cardiologists, ophthalmologists, and podiatrists) with experience in diabetes-related complications are essential.¹⁹

For most patients, a flexible treatment plan is devised that includes healthy food choices and physical activity recommendations, along with the use of oral hypoglycemic medications, insulin injections, and insulin pumps (see Box 14.4).¹⁹ These therapies generally are provided over many years.^{4,19} Management also involves medications to address the vascular, kidney, and ocular complications, including antihypertensive drugs such as angiotensin-converting enzyme inhibitors that reduce blood pressure, slow the decline of overall renal function, and reduce progression to diabetic neuropathy.^{4,19,31-35} If standard therapies fail, pancreas and kidney transplantation or transplantation of pancreatic islet cells into the recipient's liver is an option. However, transplantations are associated with a number of complications (see Chapter 21) including the lack of sufficient number of organ donors and less than 60% survival at 10 years.³⁶

Because the complications of diabetes are related to glycemic control, normoglycemia is the desired, but often elusive, goal for most patients. Normalization or near normalization of the plasma glucose for long periods of time is extremely difficult, as demonstrated by recent studies.⁷⁻⁹ Regardless of the level of hyperglycemia,

BOX 14.4 Medical Management of Diabetes Mellitus

Type 1 Diabetes

- Diet and physical activity
- Insulin
 - Conventional
 - Multiple injections
 - Continuous infusion
 - Pancreatic transplantation (see Chapter 21)

Type 2 Diabetes

- Diet and physical activity
- Oral hypoglycemic agents
- Insulin plus oral hypoglycemic agents
- Insulin

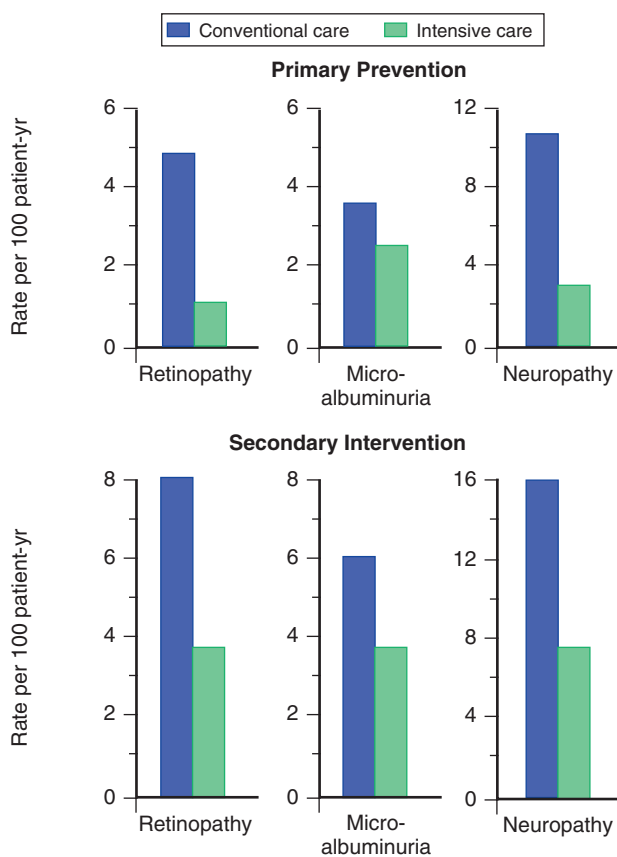

FIG 14.6 Summary of the results of the Diabetes Control and Complications Trial (DCCT).

improvement in glycemic control will lower the risk of diabetes-specific complications (Fig. 14.6).²⁷⁻³³

The target for glycemic control (as reflected by the HbA_{1c}) must be individualized, and the goals of therapy should be developed in consultation with the patient after considering a number of medical, social, and lifestyle issues.¹⁹ The ADA calls this a *patient-centered approach*, which suggests an individualized glycemic goal.¹⁰ In general, the ADA suggests that the goal is to achieve an

HbA_{1c} as close to normal as possible without significant hypoglycemia. In most individuals, the target HbA_{1c} should be less than 7% with a more stringent target for some patients.¹⁰ For instance, the HbA_{1c} goal in a young adult with type 1 diabetes may be 6.5%. A higher HbA_{1c} goal (8.0% or 8.5%) may be appropriate for very young or old patients or in individuals with limited life spans or comorbid conditions.¹⁰

Type 1 Diabetes Mellitus

General Aspects. The goal is to design and implement insulin regimens that mimic physiologic insulin secretion. Because individuals with type 1 diabetes partially or completely lack endogenous insulin production, administration of basal insulin is essential for regulating glycogen breakdown, gluconeogenesis, lipolysis, and ketogenesis. Likewise, insulin replacement for meals should be appropriate for the carbohydrate intake and promote normal glucose utilization and storage. The type of insulin selected for treatment is based on the speed of onset, peak effect, and duration of action.¹⁹

Intensive Management. Intensive diabetes management has the goal of achieving near-normal glycemia. This approach requires multiple resources, including thorough and continuing patient education, comprehensive recording of plasma glucose measurements and nutrition intake by the patient, and a variable insulin regimen that matches glucose intake and insulin dose. Insulin regimens usually include multiple-component insulin regimens, multiple daily injections (MDIs), or insulin infusion devices (each discussed later).¹⁹ The benefits of intensive diabetes management and improved glycemic control include a reduction in the microvascular complications of diabetes and a reduction in diabetes-related complications. Intensive diabetes management before and during pregnancy reduces the risk of fetal malformations and morbidity.^{6,8,19,24,25}

Insulin Preparations. Current insulin preparations are generated by recombinant DNA technology and consist of the amino acid sequence of human insulin or variations thereof (Table 14.6). In the United States, most insulin is formulated as U-100 (100 units/mL). Regular insulin formulated as U-500 (500 units/mL) is available and sometimes useful in patients with severe insulin resistance. Human insulin has been formulated with distinctive pharmacokinetics or genetically modified to more closely mimic physiologic insulin secretion. Insulins can be classified as short or long acting.¹⁹ For example, one short-acting insulin formulation, insulin lispro, is an insulin analogue in which the 28th and 29th amino acids (lysine and proline) on the insulin B chain have been reversed by recombinant DNA technology. Insulin aspart and insulin glulisine are genetically modified insulin analogues with properties similar to lispro. All three of the insulin analogues have full biologic activity but less tendency for self-aggregation, resulting in more rapid absorption and onset of action and a shorter duration of action.¹⁹ The shorter duration of action also appears to be associated

TABLE 14.6 Insulin Preparations Classified by Pharmacodynamic Profile

	Onset of Action (hr)	Peak Action (hr)	Duration of Action (hr)
RAPID ACTING			
Insulin aspart	0.25–0.5	0.5–2.5	≤5
Insulin lispro	<0.25	1–3	3–5
SHORT ACTING			
Regular (soluble)	0.5–1	2–4	5–8
INTERMEDIATE ACTING			
NPH (Isophane)	1–2	2–8	14–24
Lente (insulin zinc suspension)	1–2	3–10	20–24
LONG ACTING			
Ultralente	0.5–3	4–20	20–36
Insulin glargine	2–4	No pronounced peak	20–24
Insulin detemir	1	6–8	6–23
PREMIXED COMBINATIONS			
50% NPH, 50% regular	0.5–1	Dual (≈4)	14–24
70% NPH, 30% regular	0.5–1	Dual (≈4)	14–24
70% NPA, 30% aspart	<0.25	Dual (≈3)	14–24
75% NPL, 25% lispro	<0.25	Dual (≈4)	14–24

NPA, Neutral protamine aspart; NPL, neutral protamine lispro. Both NPA and NPL are stable premixed combinations of intermediate- and short-acting insulins.

Data from Wolfsdorf JI, Weinstein DA: Management of diabetes in children. In DeGroot LJ, Jameson JL: *Endocrinology*, ed 5, Philadelphia, 2006, Saunders and Inzucchi SE, Sherwin RS: *Diabetes mellitus*. In Goldman L, Ausiello D, editors: *Cecil medicine*, ed 23, Philadelphia, 2008, Saunders.

with a decreased number of hypoglycemic episodes, primarily because insulin levels decline in plasma glucose after a meal. Thus, insulin aspart, lispro, or glulisine is preferred over regular insulin for prandial coverage.¹⁹ Insulin glargine is a long-acting biosynthetic human insulin that differs from normal insulin in that asparagine is replaced by glycine at amino acid 21, and two arginine residues are added to the C terminus of the B chain. Compared with neutral protamine Hagedorn (NPH) insulin, the onset of insulin glargine action is later, the duration of action is longer (≈24 hours), and there is a less pronounced peak (see Table 14.6).¹⁹ A lower incidence of hypoglycemia, especially at night, has been reported with insulin glargine compared with NPH insulin. Insulin detemir has a fatty acid side chain that prolongs its action by slowing absorption and catabolism. Twice-daily injections of glargine or detemir are sometimes required to provide 24-hour coverage. Regular and NPH insulin have the native insulin amino acid sequence.¹⁹

Basal insulin requirements are provided by long-acting (NPH insulin, insulin glargine, or insulin detemir) insulin formulations.^{19,31-34} These are usually prescribed with short-acting insulin in an attempt to mimic physiologic insulin release with meals. Several insulin formulations are available as insulin “pens,” which may be more convenient for some patients. Insulin delivery by inhalation (Exubera) has recently been approved but is not used.^{35,36} Other insulins are under development (see Table 14.6).

Insulin Regimens. Representations of the various insulin regimens that may be used in type 1 diabetes are illustrated in Fig. 14.7.^{19,31-34} Although the insulin profiles are depicted as “smooth,” symmetric curves, there is considerable patient-to-patient variation in the peak and duration. In all regimens, long-acting insulins (NPH, glargine, or detemir) supply basal insulin, but regular, insulin aspart, glulisine, or lispro insulin provides prandial insulin. Short-acting insulin analogues should be injected just before (<10 min) or just after a meal; regular insulin is given 30 to 45 min before a meal. Sometimes short-acting insulin analogues are injected just after a meal (gastroparesis, it is after a large meal when the bolus of food causes the blood glucose to rise).^{19,31-34}

A shortcoming of current insulin regimens is that injected insulin immediately enters the systemic circulation, but endogenous insulin is secreted into the portal venous system. Thus, exogenous insulin administration exposes the liver to subphysiologic insulin levels. Insulin regimens do not reproduce the precise insulin secretory pattern of the pancreatic islet. The most physiologic regimens entail more frequent insulin injections, greater reliance on short-acting insulin, and more frequent capillary plasma glucose measurements. In general, individuals with type 1 diabetes require 0.5 to 1 U/kg per day of insulin divided into multiple doses, with about 50% of the insulin given as basal insulin.^{19,31-34}

Multicomponent insulin regimens refer to the combination of basal insulin and bolus insulin (preprandial short-acting insulin). The timing and dose of short-acting, preprandial insulin are altered to accommodate the self-monitoring of blood glucose (SMBG) results, anticipated food intake, and physical activity. Such regimens offer patients the best chance for achieving near normoglycemia (see Fig. 14.7).^{19,31-34}

Premixed human insulin analogues are available. Commonly used mixtures include NPH—regular (70:30); insulin lispro protamine suspension—insulin lispro (75:25); and insulin aspart protamine suspension—insulin aspart (70:30).^{19,31-34} Pramlintide, a noninsulin product, is also approved for the treatment of patients with type 1 and type 2 diabetes who have failed other insulin therapies (see Tables 14.6 and 14.7).¹⁹

Continuous subcutaneous insulin infusion (CSII) is a very effective insulin regimen for patients with type 1 diabetes.^{37,38} These “pumps” consist of a real-time sensor and can provide continuous subcutaneous infusion of rapid-acting (or, less commonly, short-acting) insulin

Insulin regimens

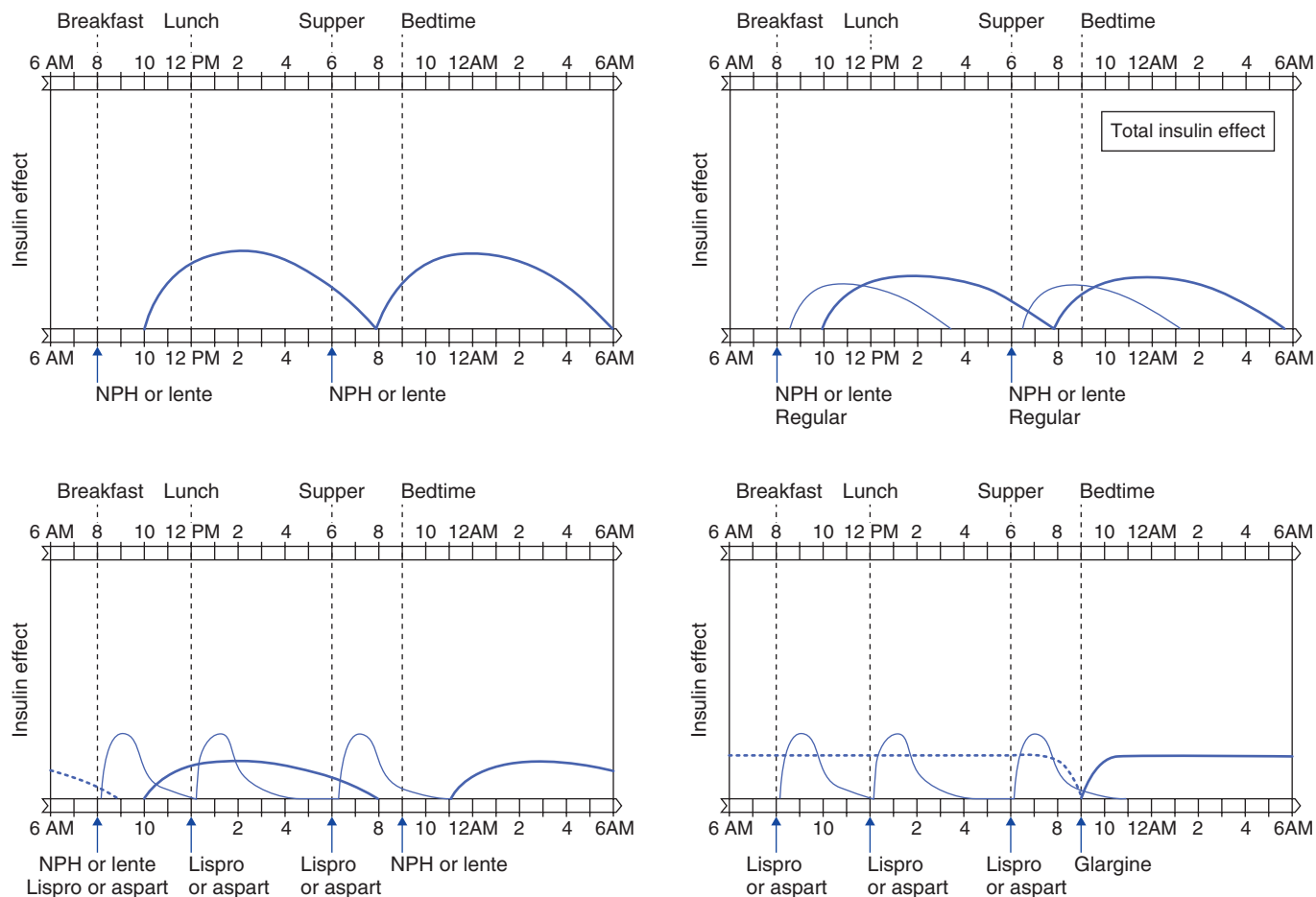

FIG 14.7 Graphs of plasma insulin levels from different types of insulin.

through a catheter inserted into the subcutaneous tissue of the patient's abdomen (Fig. 14.8).^{37,38} These sophisticated insulin infusion devices can accurately deliver small doses of insulin (microliters per hour) and have several advantages: (1) multiple basal infusion rates can be programmed to accommodate nocturnal versus daytime basal insulin requirement, (2) basal infusion rates can be altered during periods of exercise, (3) different waveforms of insulin infusion with meal-related bolus allow better matching of insulin depending on meal composition, and (4) programmed algorithms consider prior insulin administration and blood glucose values in calculating the insulin dose. Insulin infusion devices present unique challenges, such as infection at the infusion site, unexplained hyperglycemia because the infusion set becomes obstructed, or diabetic ketoacidosis if the pump becomes disconnected. Because most physicians use lispro, glulisine, or insulin aspart in CSII, the extremely short half-life of these insulins quickly leads to insulin deficiency if the delivery system is interrupted. Essential to the safe use of infusion devices is thorough patient education about pump function and frequent SMBG.^{37,38}

Other Agents That Improve Glucose Control. The role of amylin, a 37-amino-acid peptide co-secreted with insulin from pancreatic beta cells, in normal glucose homeostasis is uncertain. However, based on the rationale that patients who are insulin deficient are also amylin deficient, an analogue of amylin (pramlintide) was created and found to reduce postprandial glycemic excursions in type 1 and type 2 diabetic patients taking insulin (Table 14.7).^{19,31,33}

Type 2 Diabetes Mellitus

General Aspects. The goals of glycemia-controlling therapy for type 2 diabetes are similar to those in type 1 diabetes.¹⁹ Whereas glycemic control tends to dominate the management of type 1 diabetes, the care of individuals with type 2 diabetes must also include attention to the treatment of conditions associated with type 2 diabetes (e.g., obesity, hypertension, dyslipidemia, cardiovascular disease) and detection and management of diabetes-related complications. Reduction in cardiovascular risk is of paramount importance because this is the leading cause of death in these individuals.^{5,19,23,27,29}

TABLE 14.7 Noninsulin Antidiabetic Drugs

Class Drug	Mechanism of Action (Target Tissue)	Principal Adverse Effects	Drug Interaction(s)
SULFONYLUREAS			
Administer 30 minutes before meals.			
First Generation			
Chlorpropamide (Diabinese, Insulase) Acetohexamide (Dymelor) Tolazamide (Tolinase) Tolbutamide (Orinase)	Enhance insulin secretion (beta cells)	Hypoglycemia, weight gain, hyperinsulinemia	Salicylates and ketoconazole increase hypoglycemia.
Second-Generation			
Glipizide (Glucotrol, Glucotrol XL) Glyburide (Micronase, Glynase, DiaBeta) Glimepiride (Amaryl)	Enhance insulin secretion (beta cells)	Hypoglycemia, weight gain, hyperinsulinemia	Corticosteroids decrease action.
BIGUANIDES			
Administer with meals.			
Metformin (Foramet)	Reduce glucose production*	GI disturbances (abdominal pain, nausea, diarrhea), lactic acidosis	—
α-GLUCOSIDASE INHIBITORS			
Administer just before meals.			
Acarbose (Precose) Miglitol (Glyset)	Delay carbohydrate digestion (gut)	GI disturbances (abdominal pain, nausea, diarrhea), liver function test elevation	—
THIAZOLIDINEDIONES GLITAZONES			
Administer with meals.			
Pioglitazone (Actos) Rosiglitazone (Avandia)	Improves insulin sensitivity (fat, muscle)	Headache, weight gain, flatulence Causes or exacerbates heart failure, decreased hemoglobin or hematocrit	—
SODIUM GLUCOSE CO-TRANSPORTER 2 INHIBITORS (SLGT2 AGENTS)			
Dapagliflozin (Farxiga), Canagliflozin (Invokana), empagliflozin (Jardiance)	Selectively inhibiting this co-transporter, which is expressed almost exclusively in the proximal, convoluted tubule in the kidney	Headache, weight gain, flatulence	May increase hypoglycemia
GLINIDES			
Administer 15 minutes before meals.			
Repaglinide (Prandin) Nateglinide (Starlix)	Enhance insulin secretion (beta cells)	Hypoglycemia (less than sulfonylureas), weight gain, hyperinsulinemia, hypersensitivity, increased uric acid levels	Increased risk of hypoglycemia with salicylates, nonselective beta blockers, NSAIDs Metabolism may be inhibited by azoles, erythromycin
INCRETIN (GLP-1) ANALOGUES			
Administer 15 minutes before meals.			
Exenatide (Byetta) <i>Injected subcutaneously</i> Liraglutide (Victoza) <i>Injected subcutaneously</i>	Enhance insulin secretion (beta cells), delay gastric emptying (gut), suppress prandial glucagon secretion	GI adverse effects (nausea, vomiting, diarrhea)	—

Continued

TABLE 14.7 Noninsulin Antidiabetic Drugs—cont'd

Class Drug	Mechanism of Action (Target Tissue)	Principal Adverse Effects	Drug Interaction(s)
AMYLIN ANALOGUE			
Administer before meals. Pramlintide (Symlin) injected subcutaneously	Aids absorption of glucose by slowing gastric emptying (gut), promotes satiety (hypothalamic receptors)	GI disturbances, headache	Avoid anticholinergics that alter GI motility. Can delay absorption of oral medications; administer oral hypoglycemic agents 1–2 hr after Symlin
DIPEPTIDYL PEPTIDASE-4 INHIBITORS			
Administer once daily regardless of meals. Linagliptin (Tradjenta)	Inhibits enzymatic breakdown of GLP-1 and GIP; increases insulin secretion; decreases glucagon secretion (pancreas)	Runny nose, headache	Hypoglycemia may occur when combined with insulin or sulfonylurea drugs.
Saxagliptin (Onglyza)		Peripheral edema	—
Sitagliptin (Januvia)		Headache	—
COMBINATION DRUGS			
Some combination drugs include glyburide and metformin (Glucovance), glipizide and metformin (Metaglip), and pioglitazone hydrochloride and glimepiride (Duetact).			

*Data from Dungan KM, Buse JB: Management of type 2 diabetes mellitus. In Jameson JL, DeGroot LJ (eds): *Endocrinology*, ed 6, Philadelphia, 2010, Saunders. *GI*, Gastrointestinal; *GIP*, gastric inhibitory polypeptide; *GLP-1*, glucagon-like peptide 1; *NSAID*, nonsteroidal antiinflammatory drug.



FIG 14.8 MiniMed Paradigm REAL-Time Revel System. The insulin pump is small and can be worn under clothing or on a belt. It delivers insulin through a tube or cannula (infusion set) that is inserted into the subcutaneous (SC) tissue. The pump can be disconnected for bathing, swimming, or changing clothes. A small sensor for glucose is inserted into the SC tissue using an automatic insertion device. Sensor data are sent to a transmitter that is attached to the skin with a waterproof adhesive patch. The transmitter sends data to the insulin pump using wireless technology. The sensor and tube (new tubing) from the pump must be relocated every 3 days to minimize the risk of infection obstruction of the tube. (Courtesy of Medtronic, Diabetes, Minneapolis, MN.)

Type 2 diabetes management should begin with lifestyle modifications, including diet, weight loss, and reduction of risk factors for cardiovascular disease⁵ (see [Box 14.5](#)). An exercise regimen to increase insulin sensitivity and promote weight loss should also be instituted. Pharmacologic approaches to the management of type 2 diabetes include oral glucose-lowering agents, insulin, and other agents that improve glucose control; most physicians and patients prefer monotherapy with oral glucose-lowering agents as the initial choice^{5,10} (see [Table 14.7](#)). The goal is an effective therapy that improves glycemic control, reduces “glucose toxicity” to beta cells, and improves endogenous insulin secretion. However, type 2 diabetes is a progressive disorder and ultimately requires multiple therapeutic agents and often insulin in most patients^{5,10} ([Fig. 14.9](#)). When oral agents fail to be effective, injectable drugs (i.e., exenatide and pramlintide and insulin) may be necessary to achieve glycemic control (see [Table 14.7](#)).^{5,10,19,31,33,39-50}

Glucose-Lowering Agents. Advances in the therapy of type 2 diabetes have generated oral glucose-lowering agents that target different pathophysiologic processes in type 2 diabetes. Based on their mechanisms of action, glucose-lowering agents are subdivided into agents that increase insulin secretion, reduce glucose production, increase insulin sensitivity, enhance glucagon-like peptide 1 (GLP-1) action, or promote urinary excretion of glucose^{5,10,19,31,33} (see [Table 14.7](#)). Glucose-lowering agents other than insulin (with the exception of amylin

BOX 14.5 Key Elements of a Comprehensive Management Plan for Patients With Diabetes Mellitus

Lifestyle Changes

- Healthy diet
- Aerobic exercise
- Weight control
- Smoking cessation
- Stress reduction

Control of Modifiable Metabolic Factors

- Glucose
- Lipids
- Blood pressure
- Aspirin prophylaxis in higher risk patients

Preventive Care

- Regular medical screening examinations
- Regular screening for albuminuria
- Regular ophthalmologic examinations
- Regular podiatric examinations (and self-examinations)
- Regular dental check-ups
- Yearly influenza vaccinations
- Pneumococcus vaccination

analogue and α -glucosidase inhibitors) are ineffective in type 1 diabetes and should not be used for glucose management of severely ill individuals with type 2 diabetes. Insulin is sometimes the initial glucose-lowering agent in patients with type 2 diabetes. The usual pharmacologic treatment of patients with type 2 diabetes begins with monotherapy.^{5,10,19,31,33,51}

Biguanides. Biguanides are insulin sensitizers and have their primary site of action in the liver or peripheral tissues. Metformin (Glucophage), representative of this class of agents, reduces hepatic glucose production and improves peripheral glucose utilization slightly^{19,31,33,34,51} (see Table 14.7). Metformin activates adenosine monophosphate (AMP)–dependent protein kinase and enters cells through organic cation transporters. (Polymorphisms of these may influence the response to metformin.) Recent evidence indicates that metformin's mechanism for reducing hepatic glucose production is to antagonize glucagon's ability to generate cAMP in hepatocytes.^{19,31,33,34,51} Metformin reduces FPG and insulin levels, improves the lipid profile, and promotes modest weight loss. An extended-release form is available and may have fewer gastrointestinal (GI) side effects (diarrhea, anorexia, nausea, metallic taste). Because of its relatively slow onset of action and GI symptoms with higher doses, the initial dose should be low and then escalated every 2 to 3 weeks based on SMBG measurements. Metformin is effective as monotherapy and can be used in combination with other oral agents or with insulin.^{19,31,33,34,51} The major toxicity of metformin, lactic acidosis, is very rare and can be prevented by careful patient selection. Vitamin B₁₂ levels are about

30% lower during metformin treatment. Metformin should not be used in patients with renal insufficiency (glomerular filtration rate [GFR] <60 mL/min), any form of acidosis, unstable congestive heart failure (CHF), liver disease, or severe hypoxemia.^{19,31,33,34,51} The National Institute for Health and Clinical Excellence in the United Kingdom suggests that metformin be used at a GFR greater than 30 mL/min, with a reduced dose when the GFR is less than 45 mL/min.⁵²

Insulin Secretagogues—Agents That Affect the ATP-Sensitive K⁺ Channel. The sulfonylureas have been used to treat diabetes since the 1950s. The sulfonylureas are insulin secretagogues that stimulate insulin secretion by interacting with the ATP-sensitive potassium channel on the beta cell. These drugs are most effective in individuals with type 2 diabetes of relatively recent onset (<5 years) who have residual endogenous insulin production. First-generation sulfonylureas (chlorpropamide, tolazamide, tolbutamide) have longer half-lives, a greater incidence of hypoglycemia, and more frequent drug interactions and are no longer used. Second-generation sulfonylureas have a more rapid onset of action and better coverage of the postprandial glucose rise, but the shorter half-life of some agents may require more than once-a-day dosing. Sulfonylureas reduce both fasting and postprandial glucose and should be initiated at low doses and increased at 1- to 2-week intervals based on SMBG. In general, sulfonylureas increase insulin acutely and thus should be taken shortly before a meal; with chronic therapy, though, the insulin release is more sustained. Glimperide and glipizide can be given in a single daily dose and are preferred over glyburide, especially in older adults. Repaglinide, nateglinide, and mitiglinide are not sulfonylureas but also interact with the ATP-sensitive potassium channel. Because of their short half-lives, these agents are given with each meal or immediately before to reduce meal-related glucose excursions.

Insulin secretagogues, especially the longer acting ones, have the potential to cause hypoglycemia, especially in older individuals. Hypoglycemia is usually related to delayed meals, increased physical activity, alcohol intake, or renal insufficiency. Individuals who ingest an overdose of some agents develop prolonged and serious hypoglycemia and should be monitored closely for surgery. Most sulfonylureas are metabolized in the liver to compounds (some of which are active) that are cleared by the kidney. Thus, their use in individuals with significant hepatic or renal dysfunction is not advisable. Weight gain, a common side effect of sulfonylurea therapy, results from the increased insulin levels and improvement in glycemic control. Some sulfonylureas have significant drug interactions with alcohol and some medications, including warfarin, aspirin, ketoconazole, α -glucosidase inhibitors, and fluconazole.

Glinides (repaglinide [Prandin] and nateglinide [Starlix]) increase the secretion of insulin in the presence of glucose in a manner similar to that of the sulfonylureas; however,

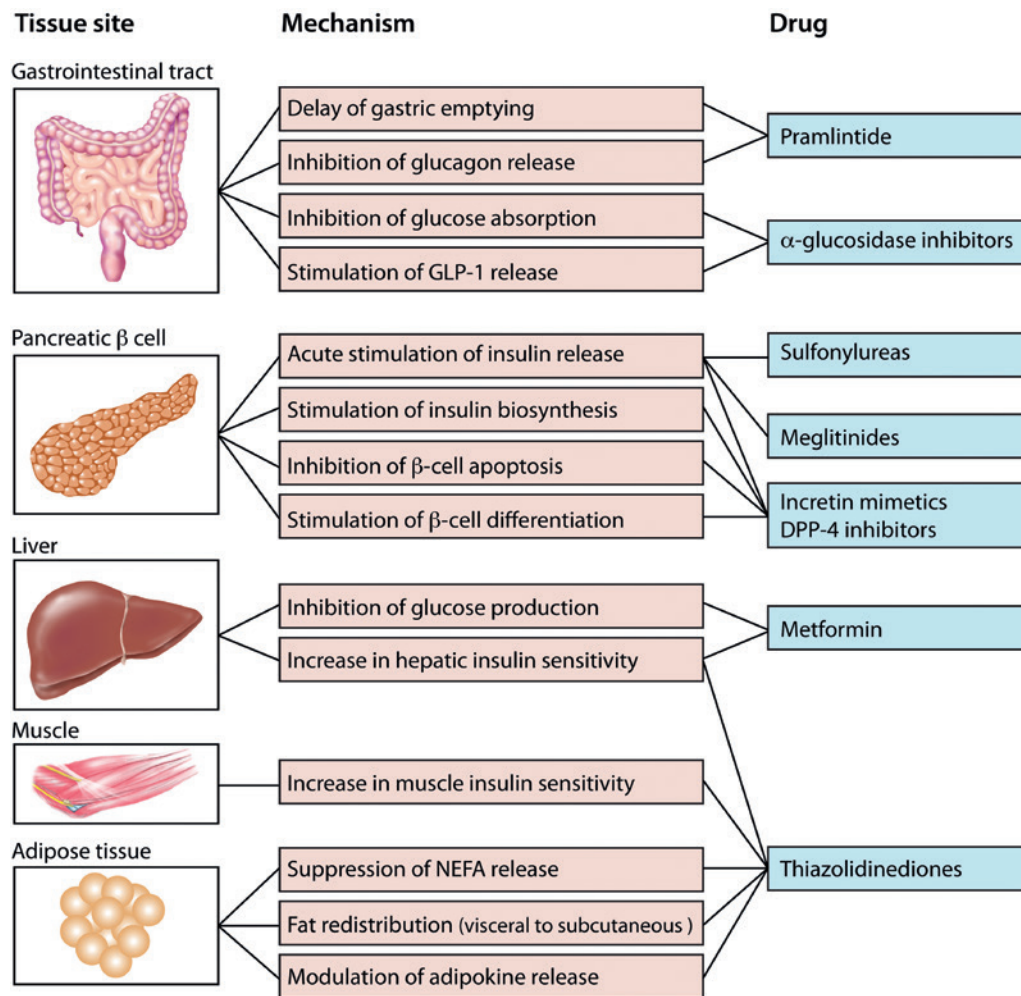

FIG 14.9 Antidiabetic agents used to treat hyperglycemia according to site and mechanism of action. *GLP-1*, Glucagon-like peptide-1; *NEFA*, nonesterified ("free" or unsaturated) fatty acids. (Courtesy Medtronic, Diabetes, Minneapolis, MN.)

they are more rapid in action and have a shorter duration. They are dosed with each meal and provide good postprandial glucose control. Lesser degrees of hypoglycemia and weight gain are associated with the glinides than with sulfonylureas.

Other oral agents available for the management of type 2 diabetes include the dipeptidyl peptidase-4 (DPP-4) inhibitors. These drugs block the enzyme responsible for the breakdown of incretins (see under Injectable Secretagogues, next). Agents such as sitagliptin (Januvia) have been shown to provide good glycemic control in monotherapy or combined with metformin (see [Table 14.7](#)).^{4,19,31,33,34,47,51}

Insulin Secretagogues—Agents That Enhance GLP-1 Receptor Signaling. “Incretins” amplify glucose-stimulated insulin secretion. Agents that either act as a GLP-1 receptor agonist or enhance endogenous GLP-1 activity are approved for the treatment of type 2 diabetes.^{19,31,34,43-45} Agents in this class do not cause hypoglycemia because of the glucose-dependent nature of incretin-stimulated insulin secretion (unless there is concomitant use of an

agent that can lead to hypoglycemia—sulfonylureas, and so on). Exenatide, a synthetic version of a peptide initially identified in the saliva of the Gila monster (exendin-4), is an analogue of GLP-1. Unlike native GLP-1, which has a half-life longer than 5 minutes, differences in the exenatide amino acid sequence render it resistant to the enzyme that degrades GLP-1 (dipeptidyl peptidase IV [DPP-IV]). Thus, exenatide has prolonged GLP-1-like action and binds to GLP-1 receptors found in islets, the GI tract, and the brain.

Liraglutide, another GLP-1 receptor agonist, is almost identical to native GLP-1 except for an amino acid substitution and addition of a fatty acyl group (coupled with a γ -glutamic acid spacer) that promote binding to albumin and plasma proteins and prolong its half-life (see [Table 14.7](#)).^{19,31,34,43-45} Liraglutide has recently (June 2016) been shown to significantly reduce cardiovascular complications in type 2 diabetes.⁵⁰ GLP-1 receptor agonists increase glucose-stimulated insulin secretion, suppress glucagon, and slow gastric emptying. These agents do not promote weight gain; in fact, most patients

experience modest weight loss and appetite suppression. Treatment with these agents should start at a low dose to minimize initial side effects (nausea being the limiting one). GLP-1 receptor agonists, available in twice-daily, daily, and weekly injectable formulations, can be used as combination therapy with metformin, sulfonylureas, and thiazolidinediones.^{19,31,34,43-45} Some patients taking insulin secretagogues may require a reduction in those agents to prevent hypoglycemia. The major side effects are nausea, vomiting, and diarrhea. Because GLP-1 receptor agonists slow gastric emptying, they may influence the absorption of other drugs. Whether GLP-1 receptor agonists enhance beta cell survival, promote beta cell proliferation, or alter the natural history of type 2 diabetes is not known. Other GLP-1 receptor agonists and formulations are under development.^{19,31,34,43-45}

α-Glucosidase Inhibitors. α-Glucosidase inhibitors reduce postprandial hyperglycemia by delaying glucose absorption; they do not affect glucose utilization or insulin secretion. Postprandial hyperglycemia, secondary to impaired hepatic and peripheral glucose disposal, contributes significantly to the hyperglycemic state in type 2 diabetes (see Table 14.7).^{19,31,34,43-45} These drugs, taken just before each meal, reduce glucose absorption by inhibiting the enzyme that cleaves oligosaccharides into simple sugars in the intestinal lumen. Therapy should be initiated at a low dose with the evening meal and increased to a maximal dose over weeks to months. The major side effects (diarrhea, flatulence, abdominal distention) are related to increased delivery of oligosaccharides to the large bowel and can be reduced somewhat by gradual upward dose titration. α-Glucosidase inhibitors may increase levels of sulfonylureas and increase the incidence of hypoglycemia. These agents should not be used in individuals with inflammatory bowel disease, gastroparesis, or serum creatinine levels greater than 177 μmol/L (2 mg/dL). This class of agents is not as potent as other oral agents in lowering the HbA_{1c} but is unique because it reduces the postprandial glucose rise even in individuals with type 1 diabetes. If hypoglycemia from other diabetes treatments occurs while taking these agents, the patient should consume additional glucose.^{19,31,34,43-45}

Thiazolidinediones. Thiazolidinediones reduce insulin resistance by binding to the PPAR-γ nuclear receptor (which forms a heterodimer with the retinoid X receptor) (see Table 14.7).^{19,31,34,46} The PPAR-γ receptor is found at highest levels in adipocytes but is expressed at lower levels in many other tissues. Agonists of this receptor regulate a large number of genes, promote adipocyte differentiation, reduce hepatic fat accumulation, and promote fatty acid storage. Thiazolidinediones promote a redistribution of fat from central to peripheral locations. Circulating insulin levels decrease with use of the thiazolidinediones, indicating a reduction in insulin resistance.^{19,31,34,46} Although rosiglitazone and pioglitazone do not appear to induce the liver abnormalities seen with troglitazone, the U.S. Food and Drug Administration

(FDA) recommends measurement of liver function tests before initiating therapy.^{19,31,34,46}

Rosiglitazone raises low LDL, HDL, and triglycerides slightly. Pioglitazone raises HDL to a greater degree and LDL a lesser degree but lowers triglycerides. The clinical significance of the lipid changes with these agents is not known and may be difficult to ascertain because most patients with type 2 diabetes are also treated with a statin.^{19,31,34,46}

Thiazolidinediones are associated with weight gain (2–3 kg), a small reduction in the hematocrit, and a mild increase in plasma volume. Peripheral edema and CHF are more common in individuals treated with these agents. These agents are contraindicated in patients with liver disease or CHF (class III or IV). The FDA has issued an alert that rare patients taking these agents may experience a worsening of diabetic macular edema. An increased risk of fractures has been noted in women taking these agents. Thiazolidinediones have been shown to induce ovulation in premenopausal women with polycystic ovary syndrome. Women should be warned about the risk of pregnancy because the safety of thiazolidinediones in pregnancy is not established.^{19,31,34,46}

Concerns about increased cardiovascular risk associated with rosiglitazone led to considerable restrictions on its use and to the FDA issuing a “black box” warning in 2007. However, based on new information, the FDA has revised its guidelines and categorizes rosiglitazone similar to other drugs for type 2 diabetes. Because of a possible increased risk of bladder cancer, pioglitazone is part of an ongoing FDA safety review.^{19,31,34}

Sodium-Glucose Co-Transporter 2 Inhibitors. Sodium-glucose co-transporter-2 (SGLT2) inhibitors are a new group of oral medications used for treating patients with type 2 diabetes (see Table 14.7). SGLT2 inhibitors have been approved for use as a treatment for diabetes since 2013.^{19,31,47} They are taken once a day with or without food.

The following drugs belong to the SGLT2 inhibitors class (gliflozins): Farxiga (dapagliflozin), Invokana (canagliflozin), and Jardiance (empagliflozin).⁴⁷ A recent study (June 2016) has demonstrated that empagliflozin significantly improves renal function and delays renal complications from type 2 diabetes.⁴⁹ Also a new gliflozin drug, sotagliflozin, has just recently (June 2016) been shown to have positive effects within the treatment of type 1 diabetes.^{53,54}

These agents lower the blood glucose by selectively inhibiting this co-transporter, which is expressed almost exclusively in the proximal, convoluted tubule in the kidney. This inhibits glucose reabsorption, lowers the renal threshold for glucose, and leads to increased urinary glucose excretion. Thus, the glucose-lowering effect is insulin independent and not related to changes in insulin sensitivity or secretion. Because these agents are the newest class to treat patients with type 2 diabetes, clinical experience is limited.^{53,54}

Because of the increased urinary glucose, urinary and vaginal infections are more common, and the diuretic effect can lead to reduced intravascular volume. As part of the FDA approval of canagliflozin in 2013, postmarketing studies for cardiovascular outcomes and for monitoring bladder and urinary cancer risk are under way.^{53,54}

Combination Therapy. A number of combinations of therapeutic agents are successful in type 2 diabetes (e.g., metformin + second oral agent, metformin + GLP-1 receptor agonist, or metformin + insulin), and the dosing of agents in combination is the same as when the agents are used alone³⁹⁻⁴² (Fig. 14.10).

Treatment with insulin becomes necessary as type 2 diabetes enters the phase of relative insulin deficiency (as seen in long-standing diabetes) and is signaled by inadequate glycemic control with one or two oral glucose-lowering agents.^{19,31,33} Insulin alone or in combination should be used in patients who fail to reach the glycemic target. For example, a single dose of long-acting insulin at bedtime is often effective in combination with metformin. Often insulin regimens in type 2 diabetes are identical to the long-acting and short-acting combination regimens discussed above for type 1 diabetes. Because the hyperglycemia of type 2 diabetes tends to be more “stable,” these regimens can be increased in 10% increments every 2 to 3 days using the fasting blood glucose results. Weight gain and hypoglycemia are the major adverse effects of insulin therapy. The daily insulin dose required can become

quite large (1–2 units/kg per day) as endogenous insulin production falls and insulin resistance persists. The addition of metformin or a thiazolidinedione can reduce insulin requirements in some individuals with type 2 diabetes while maintaining or even improving glycemic control.^{19,31,31}

Emerging Therapies. Whole-pancreas transplantation (performed concomitantly with a renal transplant) may normalize glucose tolerance and is an important therapeutic option in type 1 diabetes with ESRD, although it requires substantial expertise and is associated with the side effects of immunosuppression.^{19,55} Pancreatic islet transplantation has been plagued by limitations in pancreatic islet supply and graft survival and remains an area of clinical investigation.⁵⁵ Many individuals with long-standing type 1 diabetes still produce very small amounts of insulin or have insulin-positive cells within the pancreas. This suggests that beta cells may slowly regenerate but are quickly destroyed by the autoimmune process. Thus, efforts to suppress the autoimmune process and to stimulate beta cell regeneration are being tested both at the time of diagnosis and in years after the diagnosis of type 1 diabetes.^{19,55} Closed-loop pumps that infuse the appropriate amount of insulin in response to changing glucose levels are potentially feasible now that CGM (computerized glucose monitoring) technology has been developed. Bihormonal pumps that deliver both insulin and glucagon are under development.⁵⁶ New therapies under development for type 2 diabetes include activators of glucokinase,

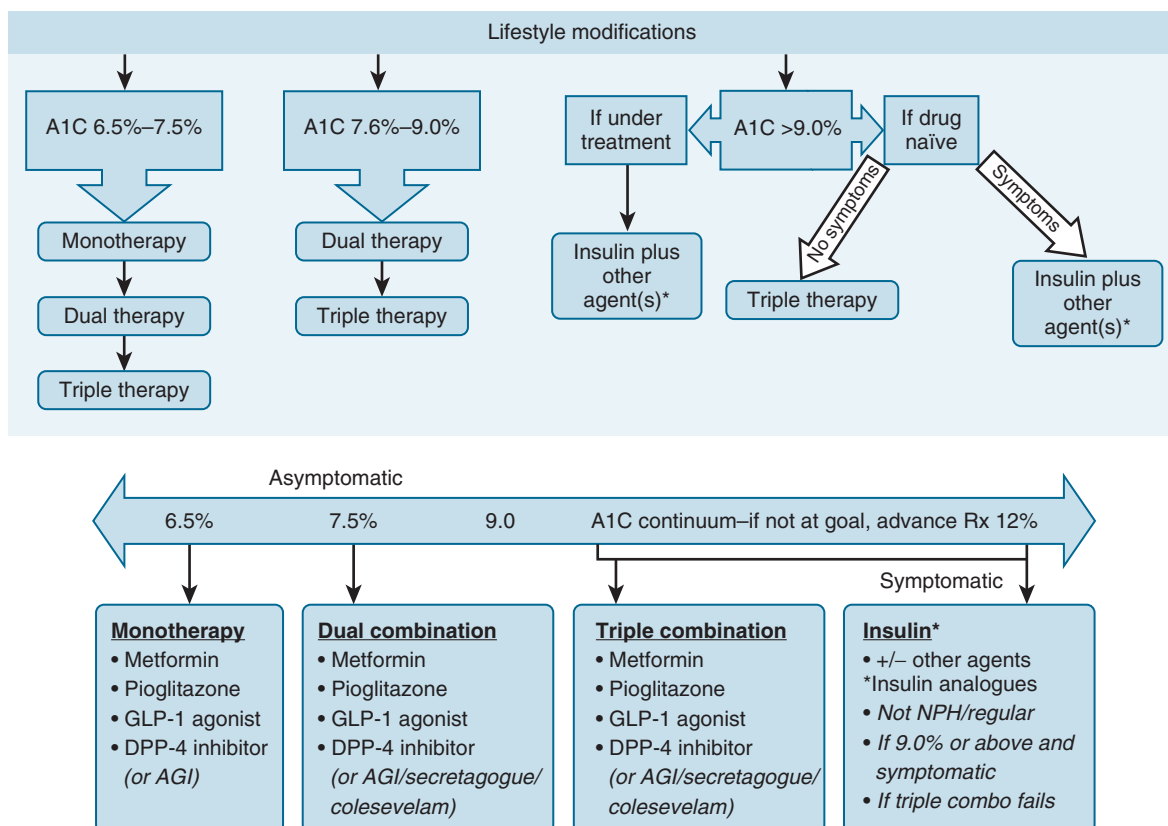

FIG 14.10 Management of type 2 diabetes based on HbA_{1c} levels (Unger).

inhibitors of 11 β -hydroxysteroid dehydrogenase-1, GPR40 agonists, monoclonal antibodies to reduce inflammation, and salsalate.^{19,33,41,42} Also, bariatric surgery for obese individuals with type 2 diabetes has shown considerable promise, sometimes with dramatic resolution of the diabetes or major reductions in the needed dose of glucose-lowering therapies.^{19,31,33}

Insulin Shock

Patients who are treated with insulin must closely adhere to their diets. If they fail to eat in accordance with their diabetes management plan (consumption of adequate calories at proper intervals) but continue to take their regular insulin injections, they may experience a hypoglycemic reaction caused by an excess of insulin (insulin shock). A hypoglycemic reaction also may be caused by an overdose of insulin or an oral hypoglycemic agent, particularly sulfonylurea drugs. Reaction or shock caused by excess insulin usually occurs in three well-defined stages, each more severe and dangerous than the one preceding it (Box 14.6).

Mild Stage. The mild stage is characterized by hunger, weakness, trembling, tachycardia, pallor, and sweating; paresthesias may be noted on occasion. It may occur before meals, during exercise, or when food has been omitted or delayed.

Moderate Stage. In this stage, the patient becomes incoherent, uncooperative, and sometimes belligerent or resistant to reason or efforts at restraint; judgment and orientation are defective. The chief danger is that patients may injure themselves or someone else (e.g., if the affected person is driving) during this stage.

BOX 14.6 Signs and Symptoms of Insulin Reaction

Mild Stage

- Hunger
- Weakness
- Tachycardia
- Pallor
- Sweating
- Paresthesias

Moderate Stage

- Incoherence
- Uncooperativeness
- Belligerence
- Lack of judgment
- Poor orientation

Severe Stage

- Unconsciousness
- Tonic or clonic movements
- Hypotension
- Hypothermia
- Rapid, thready pulse

Severe Stage. Complete unconsciousness with or without tonic or clonic muscular movements occurs during the severe stage. Most of these reactions take place during sleep, after the first two stages have gone unrecognized. The onset also may occur after exercise or after the ingestion of alcohol if earlier signs have been ignored. Sweating, pallor, rapid and thready pulse, hypotension, and hypothermia may be present (see Box 14.6).

Insulin shock can be corrected by giving the patient sweetened fruit juice or anything with sugar in it (e.g., cake icing). Patients in the severe stage (unconsciousness) are best treated with an intravenous glucose solution; glucagon or epinephrine may be used for transient relief.

DENTAL MANAGEMENT

According to some sources, diabetes may be undiagnosed in as many as 50% of all patients who have the condition presenting for dental treatment.⁵⁷ Any dental patient whose condition remains undiagnosed but who has the cardinal signs and symptoms of diabetes (i.e., polydipsia, polyuria, polyphagia, weight loss, and weakness) should be referred to a physician for diagnosis and treatment. Patients with findings suggestive of diabetes (headache, dry mouth, marked irritability, repeated skin infection, blurred vision, paresthesias, progressive periodontal disease, multiple periodontal abscesses, loss of sensation) should be referred to a clinical laboratory or to a physician for screening tests to determine if diabetes mellitus type 1 or type 2 or another type of diabetes is responsible for their symptoms.^{58,59}

Patients should monitor their blood glucose level with the use of a personal blood glucose monitoring device (e.g., glucometer or GlucoWatch). Patients with an estimated fasting blood glucose level of 126 mg/100 mL or higher should be referred to a physician for medical evaluation and treatment, if indicated. Those with a 2-hour postprandial blood glucose level of 200 mg/100 mL or higher also should be referred.^{58,59} Unfortunately, it has been shown in several studies that patients with diabetes presenting for dental care commonly are not under good glycemic control.⁵⁷⁻⁶⁰

Patients who are obese, who are older than 45 years of age, or who have close relatives with diabetes should be screened routinely (at least at 3-year intervals) for any indication of hyperglycemia that may reveal the onset of diabetes. Women who have given birth to large babies (birth weight >9 lb) or who have had multiple spontaneous abortions or stillbirths also should be screened once a year for diabetes.⁵⁷⁻⁶⁰

All patients with diagnosed diabetes must be identified by history, and the type of medical treatment they are receiving must be established (Box 14.7). The type of diabetes (type 1, type 2, other) should be determined and the presence of complications noted. Patients who are being treated with insulin should be asked how much insulin they use and how often they inject themselves

BOX 14.7 Clinical Detection of Patients With Diabetes

Patient With Known Diabetes

1. Detection by history
 - a. Are you diabetic?
 - b. What medications are you taking?
 - c. Are you being treated by a physician?
2. Establishment of severity of disease and degree of "control"
 - a. When were you first diagnosed as diabetic?
 - b. What was the level of the last measurement of your blood glucose?
 - c. What is the usual level of blood glucose for you?
 - d. How are you being treated for your diabetes?
 - e. How often do you have insulin reactions?
 - f. How much insulin do you take with each injection, and how often do you receive injections?
 - g. How often do you test your blood glucose?
 - h. When did you last visit your physician?
 - i. Do you have any symptoms of diabetes at the present time?

Patient With Undiagnosed Diabetes

1. History of signs or symptoms of diabetes or its complications
2. High risk for developing diabetes:
 - a. Presence of diabetes in a parent
 - b. Giving birth to one or more large babies (>9 lb)
 - c. History of spontaneous abortions or stillbirths
 - d. Obesity
 - e. Age older than 40 years
3. Referral or screening test for diabetes

each day. They also should be asked whether they monitor their own blood glucose and, if so, by which method, how often, and the value of the most recent level. In addition, the following should be ascertained: (1) the frequency of insulin reactions and when the last one occurred, (2) the frequency of visits to the physician, (3) the frequency and results of the last HbA_{1C} test, (4) how often the patient self-monitors her or his blood glucose levels, and (5) the glucose monitoring system and regimen used by the patient.

Vital signs also serve as a guide to the control and management of disease in the patients with diabetes. Patients with abnormal pulse rate and rhythm or elevated blood pressure should be approached with a measure of caution. Functional capacity is important for determination of the severity and level of control of diabetes and should be part of the patient's evaluation before dental treatment. Overall poor functional capacity (i.e., <4 metabolic equivalent levels [METs]) increases the risk of complications during and after dental treatment. The risk for serious cardiovascular events increases substantially in patients with diminished functional capacity to less than 4 METs—that is, those who have difficulty completing normal daily physical activities (see [Chapter 1](#)). These patients should be approached with caution.^{60,61}

Analgesics. Aspirin and nonsteroidal antiinflammatory drugs can potentially enhance the efficacy of some oral

hypoglycemic agents (sulfonylureas) and enhance hypoglycemia; thus, they should be used judiciously.

Antibiotics. Patients with well-controlled diabetes require no special attention when receiving dental treatment unless they develop a significant dental or oral infection that is possibly accompanied by swelling or fever. In contrast, patients with complications such as renal disease or cardiovascular disease may require specific alterations in dental management.⁵⁷⁻⁶⁰ Those who are treated with insulin or who are not under good medical management require special attention ([Box 14.8](#)). The decision to use antibiotic prophylaxis or coverage typically involves consultation with the patient's physician and is related to poor glycemic control.

Patients who have brittle diabetes (in which control is very difficult to achieve) or who require a high dosage of insulin (in type 1 diabetes) and are undergoing an invasive procedure may be at increased risk for postoperative infection. However, prophylactic antibiotics usually are not indicated. If the patient develops an infection, appropriate systemic antibiotics may be given.

An acute dental or oral infection in a patient with diabetes is a potential significant management problem ([Box 14.9](#)). Management is even more difficult in patients who take a high insulin dosage and those who have type 1 diabetes. Infection often leads to loss of control over the diabetic condition; as a result, infection is not well handled by the body's defenses, as it would be in a normal patient. Patients with brittle diabetes (e.g., necessitating a high dosage of insulin) may require hospitalization for adequate management of an infection. The patient's physician should be consulted and should become a partner during this period.⁵⁷⁻⁶⁰

The risk for infection in patients with diabetes is, in theory, directly related to fasting blood glucose levels, presence of infecting organisms, and invasiveness of dental procedures. As indicated by data for general surgery procedures, if the fasting blood glucose level is below 206 mg/100 mL, increased risk is not predicted. However, if the fasting blood glucose level is between 207 and 229 mg/100 mL, the risk is predicted to be increased by 20% if surgical procedures are being performed. Additionally, if the fasting blood glucose level rises to above 230 mg/100 mL, an 80% increased risk of infection postoperatively has been reported.^{62,63} Although these studies predict risk based on nonoral surgical procedures, dentists should be aware of the level of glycemic control in patients undergoing complex oral surgical procedures because of the predicted increased risk of infection. Judicious monitoring and appropriate use of antibiotics should be considered in the management of these patients.⁶⁰

The basic aim of treatment in this setting is to simultaneously cure the oral infection and restore control of the patient's blood glucose level. Patients who are receiving insulin usually require additional insulin, which should be prescribed by their physicians. Non-insulin-controlled patients may need more aggressive medical management

BOX 14.8 Dental Management Considerations in the Patient With Diabetes**P****Patient Evaluation and Risk Assessment (see Box 1.1)**

- Evaluate and determine whether diabetes exists.
- Obtain medical consultation if glycemic control is poor or if signs and symptoms point to an undiagnosed problem or if the diagnosis is uncertain. If diabetes is well controlled,* all routine dental procedures can be performed without special precautions. Morning appointments usually are best.

Potential Issues and Factors of Concern**A**

Analgesics	Avoid use of aspirin and other NSAIDs in patients taking sulfonylureas because they can worsen hypoglycemia.
Antibiotics	Prophylactic antibiotics generally are not required. Antibiotics may be prescribed for a patient with brittle (very difficult to control) diabetes for whom an invasive procedure is planned but whose oral health is poor and the fasting plasma glucose exceeds 200 mg/dL. Manage infections aggressively by incision and drainage, extraction, pulpotomy, warm rinses, and antibiotics.
Anesthesia	No issues if diabetes is well controlled. For diabetic patients with concurrent hypertension or history of recent MI or with a cardiac arrhythmia, the dose of epinephrine should be limited to no more than two cartridges containing 1:100,000 epinephrine.
Anxiety	No issues
Allergy	No issues

B

Bleeding	For surgical issues, see Notes on Surgery below. Thrombocytopenia is a rare adverse effect associated with sulfonylureas.
Breathing	No issues
Blood pressure	Monitor blood pressure because diabetes is associated with hypertension.

C

Chair position	No issues
Cardiovascular	Confirm cardiovascular status. Beta-blocker drugs can exacerbate hypoglycemia in patients taking sulfonylureas.

D

Devices	An insulin pump may be worn by the patient. Ensure it is attached and working properly. Antibiotic prophylaxis is not needed.
Drugs	Patient advised to take usual insulin dosage and normal meals on day of dental appointment; information confirmed with patient at appointment.
Drug interactions	See Table 14.7: Noninsulin Antidiabetic Drugs.

E

Equipment	Use office Glucometer to ensure good glucose control.
Emergencies and urgencies	Advise patient to inform dentist or staff if symptoms of insulin reaction occur during dental visit. Have glucose source (orange juice, soda, cake icing) available; give to the patient if symptoms of insulin reaction occur.

F

Follow-up	Routine and periodic follow-up evaluation is advised for patients who have diabetes. Inspect for oral lesions as a way to monitor for disease progression. Poor periodontal health is associated with poor glycemic control.
-----------	--

Notes on Surgery

If extensive surgery is needed:

- Consult with patient's physician concerning dietary needs during postoperative period.
- If diabetes is not well controlled (i.e., fasting blood glucose <70 mg/dL or >200 mg/dL and comorbidities [post-MI, renal disease, CHF, symptomatic angina, old age, cardiac dysrhythmias, cerebrovascular accident] are present and blood pressure >180/110 mm Hg or functional capacity <4):
 - Provide appropriate emergency care only.
 - Request referral for medical evaluation, management, and risk factor modification.
- If patient is symptomatic, seek IMMEDIATE referral.
- If patient is asymptomatic, request routine referral.

NOTE: special precautions may be needed for patients with complications of diabetes, renal disease, or heart disease.

*Well-controlled: fasting blood glucose between 70 and 200 mg/dL and no complications (i.e., after myocardial infarction [MI], renal disease, congestive heart failure [CHF], symptomatic angina, old age, cardiac dysrhythmia, cerebrovascular accident), blood pressure <180/110 mm Hg, and functional capacity >4 metabolic equivalents (METs).

NSAID, Nonsteroidal antiinflammatory drug.

of their diabetes, which may include insulin during this period.

The dentist should treat infection aggressively by incision and drainage, extraction, pulpotomy, warm rinses, and antibiotics. Antibiotic sensitivity testing is

recommended for patients with brittle diabetes and for those who require a high insulin dosage for control. For these patients, penicillin therapy can be initiated. Then, if the clinical response is poor, a more effective antibiotic can be selected on the basis of results of antibiotic sensitivity

BOX 14.9 Dental Management of Patients With Diabetes and Acute Oral Infections

1. Non–insulin-controlled patients may require insulin; consultation with physician is indicated.
2. Insulin-controlled patients usually require increased dosage of insulin; consultation with physician is indicated.
3. Patient with brittle diabetes or receiving high insulin dosage should have culture(s) taken from the infected area for antibiotic sensitivity testing.
 - a. Culture is sent for testing.
 - b. Antibiotic therapy is initiated.
 - c. In cases of poor clinical responses to the first antibiotic, a more effective antibiotic is selected according to sensitivity test results.
4. Infection should be treated with the use of standard methods:
 - a. Warm intraoral rinses
 - b. Incision and drainage
 - c. Pulpotomy, pulpectomy, extractions
 - d. Antibiotics

testing. Attention also should be paid to the patient's electrolyte balance and to fluid and dietary needs.⁶⁰

Anesthetics. For most patients with diabetes, routine use of local anesthetic with 1:100,000 epinephrine is well tolerated. Of note, however, epinephrine has a pharmacologic effect that is opposite that of insulin, so blood glucose could rise with the use of epinephrine.⁶¹ In diabetic patients with hypertension, history of recent MI, or cardiac arrhythmia, caution may be indicated with use of epinephrine. Guidelines for these patients are similar to those for patients with cardiovascular conditions and may be even stricter for those with diabetes and cardiovascular conditions who have functional capacity below 4 METs (see Box 14.8).⁵⁷⁻⁶¹

Complications. A patient with diabetes who is receiving good medical management and demonstrates good glycemic control without serious complications such as renal disease, hypertension, or coronary atherosclerotic heart disease can undergo any indicated dental treatment. If diabetes is under good control, even cardiac transplantation can be safely performed.⁵⁷⁻⁶⁰

In patients with diabetes who have serious medical complications, however, the plan of dental treatment may need to be altered (see Chapters 3 to 6 and 13). Studies have indicated that many dental patients who have diabetes are not under good glycemic control. Elevated fasting blood glucose levels render the dental patient more susceptible to complications. Another concern is that the patient experiences too much glycemic control (hypoglycemia), resulting in low blood glucose levels (<70 mg/dL). This situation also must be recognized and managed appropriately (Fig. 14.11). Therefore, careful and continuous monitoring of the patient's physical status are mandatory.⁵⁸

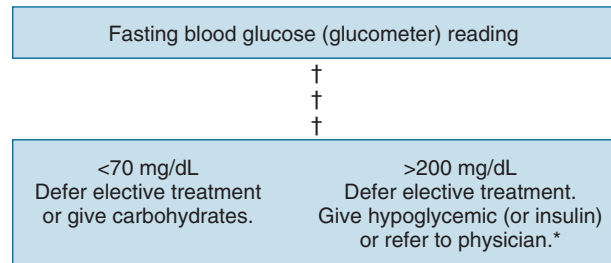

*Oral hypoglycemic agent prescribed by patient's physician.

FIG 14.11 Decision-making diagram for the dental treatment of patients with diabetes according to blood glucose (glucometer) reading.

A major goal in the dental management of patients with diabetes who are being treated with insulin is to prevent insulin shock during the dental appointment. Patients should be told to take their usual insulin dosage and to eat normal meals before the appointment, which usually is best scheduled in the morning. When such a patient arrives, the dentist should confirm that the patient has taken insulin and has eaten breakfast. In addition, patients should be instructed to tell the dentist whether at any time during the appointment they are experiencing symptoms of an insulin reaction. A source of sugar such as orange juice, cake icing, or nondiet soft drink must be available in the dental office to be given to the patient if symptoms of an insulin reaction develop (see Box 14.6 and Appendix A).

Consultation. Consultation with the patient's physician is commonly necessary to establish the level on control. Patients who have not seen their physician recently (within the previous 6 months), who have had frequent episodes of insulin shock, or who report signs and symptoms of diabetes may have disease that is unstable. These patients should be referred to their physicians for evaluation, or their physicians should be consulted to establish their current status.

Diet. Any patient with diabetes who is going to undergo extensive periodontal or oral surgery procedures other than single simple extractions should be given special dietary instructions for after surgery.^{58,64} It is important that the total caloric content and the protein–carbohydrate–fat ratio of the diet remain the same so that control of the disease and proper blood glucose balance are maintained. The patient's physician should be consulted about dietary recommendations for the postoperative period. One suggestion is to have the patient use a blender to prepare his or her usual diet so that it can be ingested with minimum discomfort; alternatively, special food supplements in a liquid form may be used. The physician also may alter the patient's insulin regimen according to ability to eat properly and according to the extent of the surgery to be performed^{19,31} (see Box 14.6).

A protocol for intravenous sedation often involves fasting before the appointment (i.e., nothing by mouth after midnight), using only half the usual insulin dose, and then supplementing with intravenous glucose during the procedure. Patients with well-controlled diabetes may be given general anesthesia if necessary. However, management with local anesthetics is preferable, especially in outpatient office settings.^{60,61}

Devices. If an insulin pump is being used by the patient, ensure that it is working properly. Antibiotic prophylaxis is not indicated.

Drugs. Some patients with type 1 diabetes who are being treated with large doses of insulin (in some cases, type 2 diabetes) experience periods of extreme hyperglycemia and hypoglycemia (brittle diabetes) even when given the best of medical management. For these patients, close consultation with the physician is required before any dental treatment is started. Certain drugs used in dentistry can alter blood glucose and interfere with the action of several drugs used to treat diabetes (insulin). See [Table 14.7](#) and [Appendix D](#) for drug interactions.

Oral Complications and Manifestations

Oral complications of poorly controlled diabetes mellitus may include xerostomia; bacterial, viral, and fungal infections (including candidiasis); poor wound healing; increased incidence and severity of caries; gingivitis and periodontal disease; periapical abscesses; and burning mouth symptoms^{26,58,62,64-67} ([Figs. 14.10 to 14.13](#)). Oral findings in patients with uncontrolled diabetes most likely relate to excessive loss of fluids through urination, altered response to infection; microvascular changes; and, possibly, increased glucose concentrations in saliva.⁶²⁻⁶⁴

The effects of hyperglycemia lead to increased amounts of urine, which depletes the extracellular fluids and reduce the secretion of saliva, resulting in dry mouth. A high percentage of patients with diabetes present with xerostomia and low levels of salivary calcium, phosphate, and fluoride.⁶³ Saliva glucose levels are elevated in persons with uncontrolled and controlled diabetes.⁶³ Several studies have reported increased incidence and severity of gingival inflammation, periodontal abscess, and chronic periodontal disease in patients with diabetes^{61,62-67} (see [Figs. 14.12 and 14.13](#)).

Diabetes results in enhanced inflammatory responses, depressed wound healing, and small blood vessel changes that contribute to an increased risk for periodontitis. Thus, it is not surprising that adults with uncontrolled diabetes have more severe manifestations of periodontal disease than do adults without diabetes. As a group, patients with controlled diabetes appear to have more severe periodontal disease than do those without it, but the differences are not great.^{62,65,65,68} The time relationship between the occurrence of the diabetic state and the onset of periodontal disease has yet to be established. However, periodontal disease is clearly a complication of type 1 and type 2 diabetes, and the association cannot be

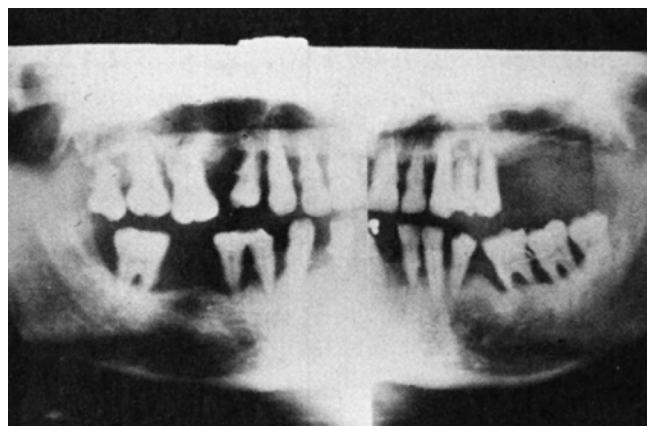

FIG 14.12 Panoramic radiograph of a young adult with severe, progressive periodontitis. After positive screening for diabetes, the patient was referred to a physician, and the diagnosis of diabetes mellitus was established. The patient required insulin treatment.



FIG 14.13 A, Patient with cellulitis resulting from a mandibular tooth abscess. **B,** Periodontal abscess in a patient with multiple abscesses. After evaluation by a physician, the diagnosis of diabetes was established.

explained solely by increased supragingival plaque accumulations.^{62,64,68} Periodontal disease found in these young adults (older than 30 years of age) usually is asymptomatic and typically remains undetected. Overall, periodontal disease is more severe and more frequent in patients with poorly controlled diabetes.^{58,62,64,68}

Caries appears to be more significant in patients with diabetes who have poor glycemic control.^{65,66} Oral fungal infections, including candidiasis and the more rare mucormycosis (Figs. 14.14 and 14.15), may be noted in the patient with uncontrolled diabetes. The general consensus is that healing is delayed in persons with uncontrolled diabetes and that they are more prone to various oral infections after undergoing surgical procedures.^{65,66} Treatment recommendations for these infections are found in Appendix C.

Oral lesions are more common in patients with diabetes. A significantly higher percentage of oral lesions, especially candidiasis, traumatic ulcers, lichen planus, and delayed healing, have been noted in patients with type 1 diabetes, compared with a control population. Altered immune system function contributes to the appearance of these lesions in diabetes.⁶⁹



FIG 14.14 Oral candidiasis in a patient with diabetes. The multiple small white lesions on the buccal mucosa were easily scraped off. Cytologic study and cultures confirmed the clinical impression of infection by *Candida albicans*.



FIG 14.15 Tan-dark brown lesion involving the palate in a patient with diabetes. Cultures established the diagnosis of mucormycosis, a serious fungal infection that may occur in patients with systemic diseases such as diabetes or cancer. Treatment usually includes control of diabetes, surgical excisions of the lesion, and administration of antibiotics and potent antifungals.

Diabetic neuropathy may lead to oral symptoms of paresthesias and tingling, numbness, burning, or pain caused by pathologic changes involving nerves in the oral region. Diabetes has been associated with oral burning symptoms. Early diagnosis and treatment of diabetes may lead to regression of these symptoms, but in long-standing cases, the changes may be irreversible.²⁶

Metformin is associated with a metallic taste.⁷⁰

REFERENCES

1. American Diabetes Association. Diagnosis and classification of diabetes mellitus. *Diabetes Care*. 2011;34(suppl 1):S62-S69. care.diabetesjournals.org.2011.
2. National diabetes statistics; 2015. <http://diabetes.niddk.nih.gov/dm/pubs/statistics/#fast>. Accessed on 11 May 2016.
3. Diabetes by race/ethnicity; 2016. <http://diabetes.org/diabetes-basics/statistics>.
4. Inzucchi SE, Sherwin RS. Type 1 Diabetes mellitus. In: Ausiello DA, Goldman L, eds. *Cecil Textbook of Medicine*. 25th ed. Elsevier; 2016:1475-1481, [Chapter 236]. ISBN 978-1-4377-1604-7.
5. Inzucchi SE, Sherwin RS. Type 2 diabetes mellitus. In: Ausiello DA, Goldman L, eds. *Cecil Textbook of Medicine*. 25th ed. Elsevier; 2016:1481-1489, [Chapter 237]. ISBN 978-1-4377-1604-7.
6. Vella A, Rizza RA, Service FJ. Hypoglycemia/pancreatic islet cell disorders. In: Ausiello DA, Goldman L, eds. *Cecil Textbook of Medicine*. 25th ed. Elsevier; 2016:1499-09. [Chapter 238]. ISBN 978-1-4377-1604-7.
7. Diabetes Control and Complications Trial Research Group. The effect of intensive treatment of diabetes on the development and progression of long-term complications in insulin-dependent diabetes mellitus. *N Engl J Med*. 1993;329:977-987.
8. Diabetes Control and Complications Trial/Epidemiology of Diabetes Intervention and Complications (DCCT/EDIC) Study Research Group. Intensive diabetes treatment and cardiovascular disease in patients with Type 1 diabetes mellitus. *N Engl J Med*. 2005;353:2643-2657.
9. Bharucha AE, Batey-Schaefer B, Cleary PA, et al; Diabetes Control and Complications Trial–Epidemiology of Diabetes Interventions and Complications Research Group. Delayed gastric emptying is associated with early and long-term hyperglycemia in type 1 diabetes mellitus. *Gastroenterology*. 2015;149(2):330-339. doi:10.1053/j.gastro.2015.05.007. [Epub 2015 May 14].
10. American Diabetes Association. Standards of medical care in diabetes. *Diabetes Care*. 2012;35(1):S2-S63.
11. Karam JG, McFarlane SI. Update on the prevention of type 2 diabetes. *Curr Diab Rep*. 2011;11:56-63.
12. Lambrinoudaki I, Vlachou SA, Creatsas G. Genetics in gestational diabetes mellitus: association with incidence, severity, pregnancy outcome and response to treatment. *Curr Diabetes Rev*. 2010;6:393-399.
13. Prediabetes FAQs (article online). <http://www.diabetes.org/diabetes-basics/prevention/pre-diabetes/pre-diabetes-faqs.html>. Accessed on 11 May 2011.

14. Blakytyn R, Jude E. The molecular biology of chronic wounds and delayed healing in diabetes. *Diabet Med*. 2006;23:594-608.
15. Nathan DM, Cleary PA, Backlund JY, et al; Diabetes Control and Complications Trial/Epidemiology of Diabetes Interventions and Complications (DCCT/EDIC) Study Research Group. Intensive diabetes treatment and cardiovascular disease in patients with type 1 diabetes. *N Engl J Med*. 2005;353:2643-2653.
16. Leal J, Gray AM, Clarke PM. Development of life-expectancy tables for people with type 2 diabetes. *Eur Heart J*. 2009;30:834-839.
17. Pera PI. Living with diabetes: quality of care and quality of life. *Patient Prefer Adherence*. 2011;5:65-72.
18. Mironidou-Tzouveleki M, Tsartsalis S, Tomos C. Vascular endothelial growth factor (VEGF) in the pathogenesis of diabetic nephropathy of type 1 diabetes mellitus. *Curr Drug Targets*. 2011;12:107-114.
19. Powers AC. Diabetes mellitus: complications. In: Kasper D, Fauci A, Braunwald R, et al, eds. *Harrison's Principles of Internal Medicine*. 19th ed. New York, NY: McGraw-Hill; 2015:[Chapter 419]. <http://accessmedicine.mhmedical.com/content.aspx?bookid=1130&Sectionid=79752952>. Accessed 7 July 2016.
20. Diabetes Control and Complications Trial (DCCT)/Epidemiology of Diabetes Interventions and Complications (EDIC) Research Group, Lachin JM, White NH, et al. Effect of intensive diabetes therapy on the progression of diabetic retinopathy in patients with type 1 diabetes: 18 years of follow-up in the DCCT/EDIC. *Diabetes*. 2015;64(2):631-642. doi:10.2337/db14-0930. [Epub 2014 Sep 9].
21. Molitch ME, Steffes M, Sun W, et al; Epidemiology of Diabetes Interventions and Complications Study Group. Development and progression of renal insufficiency with and without albuminuria in adults with type 1 diabetes in the diabetes control and complications trial and the epidemiology of diabetes interventions and complications study. *Diabetes Care*. 2010;33(7):1536-1543. doi:10.2337/dc09-1098. [Epub 2010 Apr 22].
22. DCCT/EDIC research group. Effect of intensive diabetes treatment on albuminuria in type 1 diabetes: long-term follow-up of the Diabetes Control and Complications Trial and Epidemiology of Diabetes Interventions and Complications study. *Lancet Diabetes Endocrinol*. 2014;2(10):793-800. doi:10.1016/S2213-8587(14)70155-X. [Epub 2014 Jul 17].
23. Tancredi M, Rosengren A, Olsson M, et al. The relationship between e GFR and hospitalization for heart failure in individuals with type 2 diabetes. *Diabetes Metab Res Rev*. 2016;doi:10.1002/dmrr.2793.
24. Monnier VM, Sun W, Gao X, et al. Skin collagen advanced glycation endproducts (AGEs) and the long-term progression of sub-clinical cardiovascular disease in type 1 diabetes. *Cardiovasc Diabetol*. 2015;14:118. doi:10.1186/s12933-015-0266-4. Erratum in: *Cardiovasc Diabetol*. 2015;14:138.
25. Pop-Busui R, Hotaling J, Braffett BH, et al. Cardiovascular autonomic neuropathy, erectile dysfunction and lower urinary tract symptoms in men with type 1 diabetes: findings from the DCCT/EDIC. *J Urol*. 2015;193(6):2045-2051. doi:10.1016/j.juro.2014.12.097. [Epub 2015 Jan 10]; Erratum in: *J Urol*. 2015 Sep;194(3):855.
26. Rhodus NL, Carlson CR, Miller CS. Burning mouth (syndrome) disorder. *Quintessence Int*. 2003;34:587-593.
27. Lind M, Svensson A, Kosiborod M, et al. Glycemic control and excess mortality in type 1 diabetes. *N Engl J Med*. 2014;371(21):1972-1979.
28. Hemmingsen B, Lund SS, Gluud C, et al. Targeting intensive glycemic control versus targeting conventional glycemic control for type 2 diabetes. *Cochrane Database Syst Rev*. 2013; Nov 11, 2013: CD008143, doi:10.1002/14651858.CD008143.pub3.
29. Orchard TJ, Nathan DM, Zinman B, et al; DCCT/EDIC research group. Association between seven years of intensive diabetes treatment of type 1 diabetes and long-term mortality: long-term follow-up of the Diabetes Control and Complications Trial and Epidemiology of Diabetes Interventions and Complications study. *JAMA*. 2015;313(1):45-53.
30. Fullerton B, Jeitler K, Seitz M, et al. Intensive glucose control versus conventional glucose control for type 1 diabetes. *Cochrane Database Syst Rev*. 2014;CD009122, doi:10.1002/14651858.CD009122.pub.
31. Unger J, Schwartz Z. *Diabetes Management in Primary Care*. Philadelphia: Lippincott Williams and Wilkins; 2013:340-380.
32. Powers AC. Diabetes mellitus: diagnosis, classification, and pathophysiology. In: Kasper D, Fauci A, Braunwald R, et al, eds. *Harrison's Principles of Internal Medicine*. 19th ed. New York, NY: McGraw-Hill; 2015:[Chapter 417].
33. Powers AC. Diabetes mellitus: management and therapies. In: Kasper D, Fauci A, Braunwald R, et al, eds. *Harrison's Principles of Internal Medicine*. 19th ed. New York, NY: McGraw-Hill; 2015:[Chapter 418]. <http://accessmedicine.mhmedical.com/content.aspx?bookid=1130&Sectionid=79752952>. Accessed 7 July 2016.
34. Drugs to treat diabetes. <http://www.mayoclinic.org/diseases-conditions/type-2-diabetes/diagnosis-treatment/treatment/txc-20169988>.
35. Inhaled insulin (Exubera). *Med Lett Drugs Ther*. 2006;48:57-58.
36. Baran MK, Godoy AT. What went wrong? A retrospective on Exubera. *Adv Nurse Pract*. 2008;16:53-54, 77.
37. Reznik Y. Continuous subcutaneous insulin infusion (CSII) using an external insulin pump for the treatment of type 2 diabetes. *Diabetes Metab*. 2010;36:415-421.
38. Pickup J. Insulin pumps. *Int J Clin Pract Suppl*. 2010;166:16-19.
39. Jabbour S, Ziring B. Advantages of extended-release metformin in patients with type 2 diabetes mellitus. *Postgrad Med*. 2011;123:15-23.
40. Jones MC. Therapies for diabetes: pramlintide and exenatide. *Am Fam Physician*. 2007;275:1831-1835.
41. Nyenwe EA, Jerkins TW, Umpierrez GE, et al. Management of type 2 diabetes: evolving strategies for the treatment of patients with type 2 diabetes. *Metabolism*. 2011;60:1-23.
42. Shomali M. Add-on therapies to metformin for type 2 diabetes. *Expert Opin Pharmacother*. 2011;12:47-62.

43. Drucker DJ, Nauck MA. The incretin system: glucagon-like peptide-1 receptor agonists and dipeptidyl peptidase-4 inhibitors in type 2 diabetes. *Lancet*. 2006;368:1696-1705.
44. Verspohl EJ. Novel therapeutics for type 2 diabetes: incretin hormone mimetics (glucagon-like peptide-1 receptor agonists) and dipeptidyl peptidase-4 inhibitors. *Pharmacol Ther*. 2008;124:113-138.
45. Peterson GE, Pollom RD. Liraglutide in clinical practice: dosing, safety and efficacy. *Int J Clin Pract Suppl*. 2010;64:35-43.
46. Derosa G. Efficacy and tolerability of pioglitazone in patients with type 2 diabetes mellitus: comparison with other oral antihyperglycaemic agents. *Drugs*. 2010;70:1945-1961.
47. Riggs K, Ali H, Taegtmeyer H, et al. The use of SGLT-2 inhibitors in type 2 diabetes and heart failure. *Metab Syndr Relat Disord*. 2015;13(7):292-297. doi:10.1089/met.2015.0038.
48. Twigg S, Daja MM, O'Leary BA, et al. Once-daily liraglutide (1.2 mg) compared with twice-daily exenatide (10 µg) in the treatment of type 2 diabetes patients: an indirect treatment comparison meta-analysis. *J Diabetes*. 2016;doi:10.1111/1753-0407.12372.
49. Wanner C, INzucchi S, Lachin J, et al. Empagliflozin and progression of kidney disease in type 2 diabetes. *N Engl J Med*. 2016;doi:10.1056/NEJMoa1515920.
50. Marso S, Daniels G, Brown-Frandsen K, et al. Liraglutide and cardiovascular outcomes in type 2 diabetes. *N Engl J Med*. 2016;doi:10.1056/NEJMoa1603827.
51. Stern RJ, Murphy EJ. Metformin as initial therapy in type 2 diabetes. *JAMA*. 2015;313(24):2484-2485. doi:10.1001/jama.2015.2765.
52. Type 2 diabetes management. <https://www.nice.org.uk/guidance/ng28.2015>.
53. Sotagliflozin, a dual SGLT1 and SGLT2 inhibitor, as adjunct. <http://care.diabetesjournals.org/content/early/2015/05/06/dc14-2806>.
54. Sands A, Zambrowicz BP, Rosenstock J, et al. Sotagliflozin, a dual SGLT1 and SGLT2 inhibitor, as adjunct therapy to insulin in type 1 diabetes. *Diabetes Care*. 2015 May. <http://dx.doi.org/10.2337/dc14-2806>.
55. White SA, Shaw JA, Sutherland DE. Pancreas transplantation. *Lancet*. 2009;373:1808-1817.
56. Bruttomesso D, Farret A, Costa S, et al. Closed-loop artificial pancreas using subcutaneous glucose sensing and insulin delivery and a model predictive control algorithm: preliminary studies in Padova and Montpellier. *J Diabetes Sci Technol*. 2009;3:1014-1021.
57. Rhodus NL, Vibeto BM, Hamamoto DT. Glycemic control in patients with diabetes mellitus upon admission to a dental clinic: considerations for dental management. *Quintessence Int*. 2005;36:474-482.
58. Miley BD, Terezhalmay GT. The patient with diabetes mellitus: etiology, epidemiology, principles of medical management, oral disease burden, and principles of dental management. *Quintessence Int*. 2005;36:779-795.
59. Lalla R, Lamster I. Dental management of the patient with diabetes. *Dent Clin North Am*. 2012;56:819-829. [http://dx.doi.org/10.1016/j.cden.2012.07.0080011-8532/12/\\$](http://dx.doi.org/10.1016/j.cden.2012.07.0080011-8532/12/$).
60. Guvener M, Pasaoglu I, Demircin M, et al. Perioperative hyperglycemia is a strong correlate of postoperative infection in type II diabetic patients after coronary artery bypass grafting. *Endocr J*. 2002;49:531-537.
61. Brown RS, Rhodus NL. Epinephrine and local anesthesia revisited. *Oral Surg Oral Med Oral Pathol Oral Radiol Endod*. 2005;100:401-408.
62. Demmer RT, Jacobs DR, Singh R, et al. Periodontal bacteria and prediabetes prevalence in ORIGINS. *J Dent Res*. 2016;94(9);doi:10.1177/0022034515590369.
63. Jawed M, Shahid SM, Qader SA, et al. Dental caries in diabetes mellitus: role of salivary flow rate and minerals. *J Diabetes Complications*. 2011;25:183-186.
64. Iacopino AM. Periodontitis and diabetes interrelationships: role of inflammation. *Ann Periodontol*. 2001;6:125-137.
65. Belazi M, Velegraki A, Fleva A, et al. Candidal overgrowth in diabetic patients: potential predisposing factors. *Mycoses*. 2005;48:192-196.
66. Iatta R, Napoli C, Borghi E, et al. Rare mycoses of the oral cavity: a literature epidemiologic review. *Oral Surg Oral Med Oral Pathol Oral Radiol Endod*. 2009;108:647-655.
67. Lee DH, Kim SY, Nam SY, et al. Risk factors of surgical site infection in patients undergoing major oncological surgery for head and neck cancer. *Oral Oncol*. 2011;47:528-531.
68. Sharma P, Dietrich T, Ferro CJ, et al. Severity of periodontal disease and response to therapy based upon glycemic control. *J Clin Periodontol*. 2015 Dec 31;doi:10.1111/jcpe.12502. [Epub ahead of print].
69. Marsot-Dupuch K, Quillard J, Meyohas MC. Head and neck lesions in the immunocompromised host. *Eur Radiol*. 2004;14(suppl 3):E155-E167.
70. Lee AJ. Metformin in noninsulin-dependent diabetes mellitus. *Pharmacotherapy*. 1996;16:327-351.

Adrenal Insufficiency

The adrenal glands are small (6–8 g) endocrine glands located bilaterally at the superior pole of each kidney. Each gland contains an outer cortex and an inner medulla. The adrenal medulla functions as a sympathetic ganglion and secretes catecholamines, primarily epinephrine. The adrenal cortex secretes several steroid hormones with multiple actions (Fig. 15.1).

The adrenal cortex makes up about 90% of the gland and consists of three zones. The outer zone is the *zona glomerulosa*. The middle zone is the *zona fasciculata*, and the innermost zone is the *zona reticularis*. The cortex manufactures three classes of adrenal steroids: glucocorticoids, mineralocorticoids, and androgens. All are derived from cholesterol and share a common molecular nucleus.

The predominant hormone of the zona glomerulosa is aldosterone, a mineralocorticoid that responds to hormones made by the kidneys (i.e., renin and angiotensin). Aldosterone regulates physiologic levels of sodium and potassium; these two electrolytes are important for control of intravascular volume and blood pressure. The zona fasciculata secretes glucocorticoids, and the zona reticularis secretes androgens, or sex hormones.¹

Cortisol, the primary glucocorticoid, has several important physiologic actions on digestion, metabolism, cardiovascular function, and the immune system and for maintaining homeostasis during periods of physical or emotional stress. Cortisol acts as an insulin antagonist (Fig. 15.2), increasing blood levels and peripheral use of

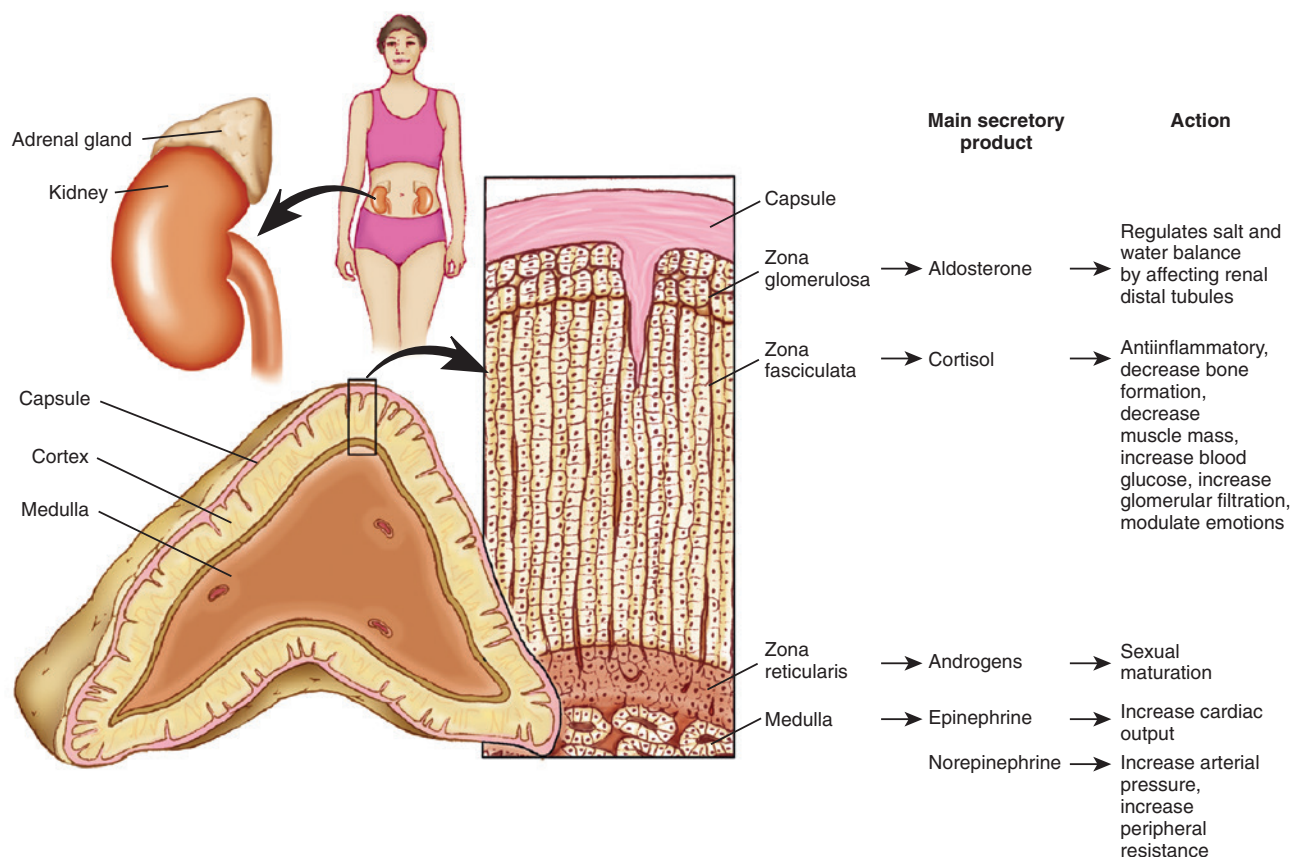

FIG 15.1 Structure of the adrenal gland, representative zones, and their main secretory products and physiologic actions. (Adapted from Thibodeau GA, Patton KT: *Anatomy and physiology*, ed 7, St. Louis, 2010, Mosby.)

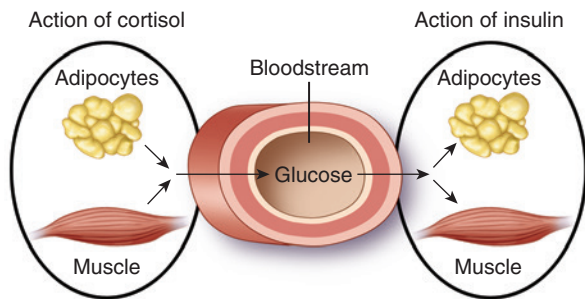

FIG 15.2 Effects of cortisol and insulin on glucose in the bloodstream.

glucose by activating key enzymes involved in hepatic gluconeogenesis and inhibiting glucose uptake in peripheral tissues (i.e., skeletal muscles).¹ In adipose tissue, cortisol activates lipolysis, resulting in the release of free fatty acids into circulation. Cortisol increases blood pressure by potentiating the vasoconstrictor action of catecholamines and angiotensin II on the kidney and vasculature.^{1,2} Its antiinflammatory action is modulated by its inhibitory action on (1) lysosome release, (2) prostaglandin production, (3) eicosanoid and cytokine release, (4) endothelial cell expression of intracellular and extracellular adhesion molecules (ICAMs and ECAMs, respectively) that attract neutrophils, and (5) leukocyte function. Cortisol also activates osteoclasts and inhibits osteoblasts.

Regulation of cortisol secretion occurs through activity of the hypothalamic–pituitary–adrenal (HPA) axis (Fig. 15.3). Central nervous system afferents mediating circadian rhythm and responses to stress stimulate the hypothalamus to release corticotropin-releasing hormone (CRH), which stimulates the production and secretion of adrenocorticotropic hormone (ACTH) by the anterior pituitary. Corticotropin (ACTH) then stimulates the adrenal cortex to produce and secrete cortisol. Plasma cortisol levels are increased within a few minutes after stimulation. Circulating levels of cortisol inhibit the production of CRH and ACTH, thus completing a negative feedback loop.¹

Cortisol secretion is pulsatile and normally follows a circadian pattern. Peak levels of plasma cortisol occur around the time of waking in the morning and are lowest in the evening and night¹ (Fig. 15.4). This pattern is reversed in a person who habitually works nights and sleeps during the day. The normal secretion rate of cortisol over a 24-hour period is approximately 20 mg.^{1,3,4} During periods of stress, the HPA axis is stimulated, resulting in increased secretion of cortisol. Anticipation of surgery or an athletic event usually is accompanied by only minimal increases in cortisol secretion. However, surgery itself is one of the most potent activators of the HPA axis.^{1,5} Also, various stressors such as trauma, illness, burns, fever, hypoglycemia, and emotional upset (e.g., anxiety) can trigger this effect.⁶ The most pronounced response is noted in the immediate postoperative period after surgery. However, this can be reduced by morphine-like analgesics,

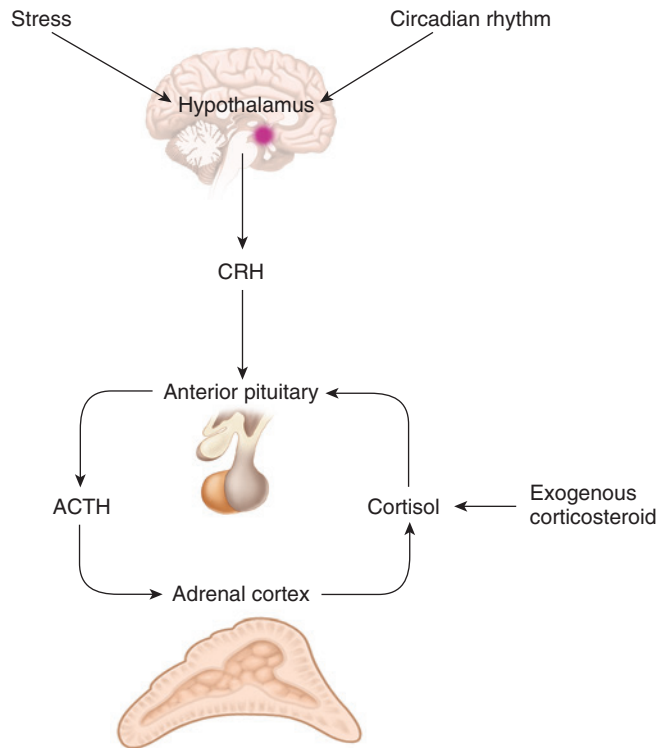

FIG 15.3 Hypothalamic–pituitary–adrenal axis and the regulation of cortisol secretion. ACTH, Adrenocorticotropic hormone; CRH, corticotropin-releasing hormone.

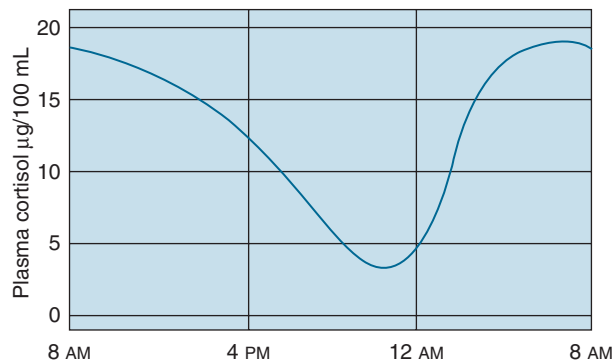

FIG 15.4 Normal pattern of cortisol secretion over a 24-hour period.

benzodiazepines, or local anesthesia, suggesting that the pain response mechanism increases the requirement for cortisol.⁷⁻⁹

Synthetic glucocorticoids (cortisol-like drugs) used in the treatment of autoimmune and inflammatory diseases (e.g., rheumatoid arthritis, systemic lupus erythematosus, asthma, hepatitis, inflammatory bowel disease, dermatoses, mucositis) can affect adrenal function. Glucocorticoids are used on a long-term basis in patients during immunosuppressive therapy for organ transplantation and joint replacement. In dentistry, corticosteroids may be used during the perioperative period for the reduction of pain, edema, and trismus after oral surgical and endodontic

TABLE 15.1 Glucocorticoids and Their Relative Potency

Compound	Antiinflammatory Potency	Mineralocorticoid Potency	Equivalent Dose* (mg)
SHORT ACTING (<12 HOURS)			
Cortisol	1	2	20
Hydrocortisone	0.8	2	20
INTERMEDIATE ACTING (12–36 HOURS)			
Prednisone	4	1	5
Prednisolone	4	1	5
Triamcinolone	5	0	4
Methylprednisolone	5	0.5	4
Fludrocortisone	15	200	1.4
LONG ACTING (>36 HOURS)			
Betamethasone	25	0	0.75
Dexamethasone	25	0	0.75
INHALED			
Beclometasone dipropionate [†]	8 puffs 4 times a day equals 14 mg oral prednisone once a day	—	—

*Approximate.

[†]Fluticasone propionate is roughly twice as potent as beclometasone dipropionate and budesonide.

Data from Barnes N: Relative safety and efficacy of inhaled corticosteroids, *J Allergy Clin Immunol* 101:S460-S64, 1998; Schimmer BP, Parker KL: In Brunton LL, Lazo JS, Parker KL et al, editors: *Goodman and Gilman's the pharmacological basis of therapeutics*, ed 11, New York, 2006, McGraw-Hill; and Kroenberg HM, et al: *Williams textbook of endocrinology*, ed 11, Philadelphia, 2008, Saunders.

procedures.^{10,11} Many synthetic glucocorticoids are available, and they differ in potency relative to cortisol and in their duration of action (Table 15.1).

MINERALOCORTICIDS

Aldosterone is the primary mineralocorticoid secreted by the adrenal cortex. It is essential to sodium and potassium balance and to the maintenance of extracellular fluid (i.e., intravascular volume) and blood pressure. Its actions occur primarily on the distal tubule and the collecting duct of the kidney, where it promotes sodium and water retention and potassium excretion. Aldosterone secretion is predominantly regulated by the renin–angiotensin system and extracellular potassium levels and less so by plasma sodium levels. Aldosterone secretion is stimulated by a fall in renal blood pressure, which results from decreased intravascular volume or a sodium imbalance.¹ The drop in volume or pressure causes renin release from the kidney, which activates angiotensinogen to form angiotensin I and II. Angiotensin II, in turn, stimulates secretion of aldosterone from the adrenal cortex. When blood pressure rises, renin–angiotensin release diminishes, serving as a negative feedback loop that inhibits additional production of aldosterone (Fig. 15.5).

ADRENAL ANDROGENS

Dehydroepiandrosterone (DHEA) is the principal androgen secreted by the adrenal cortex. The effects of adrenal

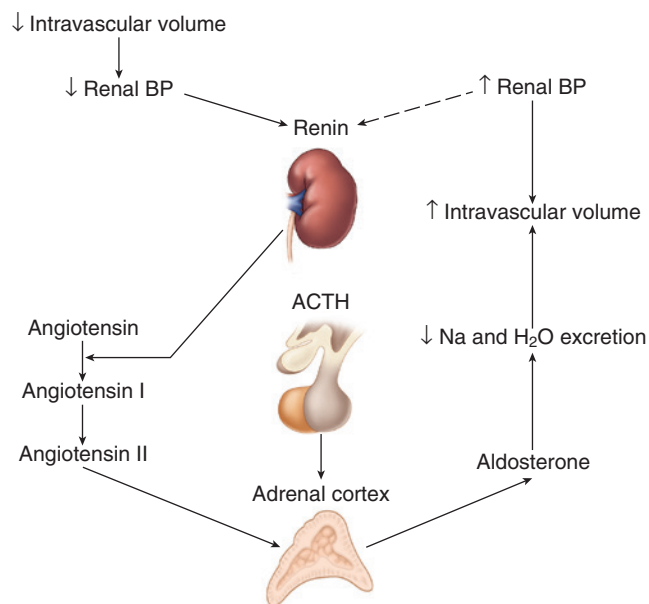

FIG 15.5 Regulation of aldosterone secretion. ACTH, Adrenocorticotropic hormone; BP, blood pressure.

androgens are the same as those of testicular androgens (i.e., masculinization and the promotion of protein anabolism and growth). The activity of the adrenal androgens, however, is only about 20% that of the testicular androgens and is of relatively minor physiologic importance.¹ Estrogen precursors are secreted from the zona reticularis of the adrenal cortex.

DEFINITION

Disorders of the adrenal glands can result in overproduction (hyperadrenalism) or underproduction (hypoadrenalism or adrenal insufficiency) of adrenal products.

Hyperadrenalism is characterized by excessive secretion of adrenal cortisol, mineralocorticoids, androgens, or estrogen in isolation or combination. The most common type of overproduction is due to glucocorticoid excess. When this is caused by pathophysiologic processes, the condition is known as *Cushing disease*.¹² The term *Cushing syndrome* is a generalized state caused by excessive cortisol in the body, regardless of the cause.

Adrenal insufficiency is divided into three categories: primary, secondary, and tertiary. Primary adrenocortical insufficiency, also known as *Addison disease*, occurs when the adrenal cortex is destroyed or the gland is removed. Secondary adrenocortical insufficiency is the consequence of pituitary disease or a lack of responsiveness of the adrenal glands to ACTH (corticotrophin) or caused by critical illness. Tertiary adrenal insufficiency results from processes that impair function of the hypothalamus, which is most commonly caused by chronic use of corticosteroids.¹³ Because abnormal adrenal function can be life threatening, these conditions are of significant concern in clinical practice.

EPIDEMIOLOGY

Adrenal insufficiency occurs in 100 to 140 per 1 million persons of all ages, with about 5 new cases per million diagnosed each year.^{14,15} The diagnosis peaks in the fourth decade of life.¹⁶ Secondary adrenocortical insufficiency is about two times more common than primary adrenal insufficiency, and diagnosis peaks in the sixth decade.¹⁷ Both conditions are more common in women, and both conditions are associated with premature death.^{18,19} Approximately 2% of adults in the United States use corticosteroids on a chronic basis and thus are at risk for tertiary adrenocortical insufficiency. A dental practice serving 2000 adults can expect to encounter 50 patients who use corticosteroids or who have potential adrenal abnormalities.

ETIOLOGY

Primary adrenocortical insufficiency is caused by progressive destruction of the adrenal cortex, primarily because of autoimmune disease in adults and less frequently from chronic infectious disease (tuberculosis, human immunodeficiency virus [HIV] infection, cytomegalovirus infection, and fungal infection) or malignancy. The condition also may result from hemorrhage (e.g., heparin or low-molecular-weight heparin use), sepsis, adrenalectomy, genetic mutations (e.g., adrenoleukodystrophy, familial glucocorticoid deficiency), or drugs (e.g., that increase

TABLE 15.2 Drugs That Interfere With Glucocorticoid Production and Increase Glucocorticoid Need

Drug Class	Generic Drug Examples
Antidepressant	Imipramine
Antifungal	Ketoconazole, fluconazole
Antipsychotic	Chlorpromazine
Antisteroid	Aminoglutethimide
Antiseizure	Phenytoin, topiramate
Antituberculosis	Rifampin
Barbiturate	Phenobarbital
Benzodiazepine	Midazolam
Diagnostic	Metyrapone
General anesthetic	Etomidate
Iron reducer (thalassemic drug)	Desferrioxamine

cortisol metabolism, inhibit gene transcription, or alter tissue resistance to glucocorticoids).^{1,20}

Secondary adrenocortical insufficiency is caused by structural lesions of the pituitary gland (e.g., tumor), removal of the pituitary gland, cranial irradiation of the pituitary gland, head trauma, and lack of responsiveness of the adrenal glands to ACTH (corticotrophin) or due to critical illness (e.g., sepsis, liver cirrhosis).

Tertiary adrenal insufficiency results from defective hypothalamus function or, more commonly, as a result of chronic administration of exogenous corticosteroids. Prolonged corticosteroid use suppresses the hypothalamic-pituitary axis, which in turn inhibits ACTH production and adrenocortical production of cortisol (see Fig. 15.3). Less common causes include administration of specific drugs (Table 15.2) or a critical illness (burns, trauma, systemic infection).

PATHOPHYSIOLOGY AND COMPLICATIONS

Primary adrenal insufficiency (Addison disease) is caused by the lack of the major hormones of the adrenal cortex: cortisol and aldosterone and to a lesser degree the androgens. Lack of cortisol results in impaired metabolism of glucose, fat, and protein, as well as hypotension, increased ACTH secretion, impaired fluid excretion, excessive pigmentation, and an inability to tolerate stress. The relationship between corticosteroids and response to stress involves the maintenance of vascular reactivity to vasoactive agents and the maintenance of normal blood pressure and cardiac output. Aldosterone deficiency results in an inability to conserve sodium and eliminate potassium and hydrogen ions, leading to hypovolemia, hyperkalemia, and acidosis.¹

Secondary and tertiary adrenal insufficiency are associated with low levels of cortisol. Unlike primary adrenal insufficiency, aldosterone is not impaired with secondary

or tertiary adrenal insufficiency. This is because aldosterone secretion is ACTH independent.

Cushing syndrome refers to a condition caused by excessive cortisol in the body. When Cushing syndrome is caused by a pathophysiologic process (e.g., tumor of the pituitary gland or tumor of the adrenal gland), it is called Cushing disease.¹² In Cushing disease, the endocrine tumor stimulates excessive circulating levels of glucocorticoids. Both Cushing disease and syndrome produce similar clinical features that result from high levels of cortisol that alters protein, carbohydrate, and fat metabolism, the effects of altered insulin and vasculature homeostasis. The most common cause of elevated cortisol levels in Cushing syndrome is the medical administration of corticosteroids (e.g., prednisone).

Corticosteroids can be administered by a variety of routes, and most medical regimens attempt to limit the dose so elevated cortisol levels, and thus adrenal suppression, do not occur. Corticosteroids that are topically applied or repeatedly locally injected or inhaled rarely induce adrenal suppression by absorption through the skin, subjacent tissues, or pulmonary alveoli.²¹ Although the amount of topical steroid required to treat small, noninflamed areas probably does not cause significant suppression, prolonged treatment of large inflamed areas may be a cause for concern, especially if occlusive dressings are used with highly potent steroids.²²⁻²⁴ Similarly, the use of inhaled corticosteroids rarely causes adrenal suppression unless they are given in frequent and high doses.²⁵ Doses above 400 to 500 µg/day in children or 800 to 1000 µg/day of beclomethasone dipropionate equivalent in adults (depending on body mass) generally are considered to represent the cutoff point, indicating that adrenal suppression is probable.^{25,26}

In patients treated with corticosteroids, after administration ceases, the HPA axis begins to regain its responsiveness, and normal ACTH and cortisol secretion eventually resume. The time required to regain normal adrenal responsiveness is thought to range from days to months. However, studies from a large review²⁷ demonstrated a return of HPA function to stress stimulation within 14 days even when supraphysiologic doses were given for 1 month or longer.

Adrenal Crisis

Adrenal crisis is a potentially life-threatening complication resulting from adrenal insufficiency triggered by emotional and physical stress (e.g., infection, fever, sepsis, surgery). It manifests as hypotensive collapse, abdominal pain, myalgia, and fever. The condition occurs at a rate of 5 to 6 events per 100 patient-years among those with primary adrenal insufficiency, with older affected adults at higher risk.^{17,28}

CLINICAL PRESENTATION

Signs and Symptoms

Hypoadrenalism. Deficiencies of adrenocortical hormones produce signs and symptoms that are often nonspecific,

leading to delays in diagnosis. Clinical evidence of adrenal deficiency generally appears only after 90% of the adrenal cortices have been destroyed.

Primary adrenal insufficiency (Addison disease) produces signs and symptoms associated with a deficiency of all adrenocortical hormones (aldosterone, cortisol, androgens). The most common complaints are weakness, fatigue, abdominal pain, and hyperpigmentation of the skin (i.e., skin areas subjected to pressure: elbows, knuckles, palmar creases) and mucous membranes (Fig. 15.6). Hypotension, anorexia, salt craving, myalgia, hypoglycemia, and weight loss are additional commonly associated features.¹ If a patient with Addison disease is challenged by emotional or physical stress (e.g., illness, infection, surgery), an *adrenal crisis* may be precipitated.²⁸ This medical emergency evolves over a few hours and manifests as severe exacerbation of the patient's condition, including sunken eyes, profuse sweating, hypotension, weak pulse, cyanosis, nausea, vomiting, weakness, headache, dehydration, fever, dyspnea, myalgias, arthralgia, hyponatremia, and eosinophilia. If not treated rapidly, the patient may develop hypothermia, severe hypotension, hypoglycemia, confusion, and circulatory collapse that can result in death.^{1,29}

Secondary and tertiary adrenal insufficiency may cause a partial insufficiency that is limited to glucocorticoids. The condition usually does not produce hyperpigmentation



FIG 15.6 Patient with Addison disease. Note bronzing of the skin with pigmentation of the lip, **A**, and the oral mucosa, **B**.

or any symptoms unless the patient is significantly stressed and does not have adequate circulating cortisol during times surrounding stress. In this event, an adrenal crisis is possible. However, an adrenal crisis in a patient with secondary or tertiary adrenal suppression is rare and tends not to be as severe as that seen with primary adrenal insufficiency because aldosterone secretion is normal. Thus, hypotension, dehydration, and shock are seldom encountered.²

Hyperadrenalism. Adrenal hyperfunction can produce four syndromes that are dependent on the adrenal product that is in excess—androgen, estrogen, mineralocorticoid, and cortisol. Androgen-related disorders are rare and primarily affect the reproductive organs. Mineralocorticoid excess (primary aldosteronism) is associated with hypertension, hypokalemia, and dependent edema (see [Chapter 3](#)). The most common form of hyperadrenalism is caused by glucocorticoid excess (endogenous or exogenous), and it leads to a syndrome known as Cushing syndrome. This syndrome classically produces weight gain, a broad and round face (“moon facies”) ([Fig. 15.7](#)), a “buffalo hump” on the upper back, abdominal striae, hypertension, hirsutism, and acne. Other findings may include glucose intolerance (e.g., diabetes mellitus), heart failure, osteoporosis and bone fractures, impaired healing, and psychiatric disorders (mental depression, mania, anxiety disorders, cognitive dysfunction, and psychosis).²¹ Long-term steroid use also may increase risks for insomnia, peptic ulceration, cataract formation, glaucoma, growth suppression, and delayed wound healing.

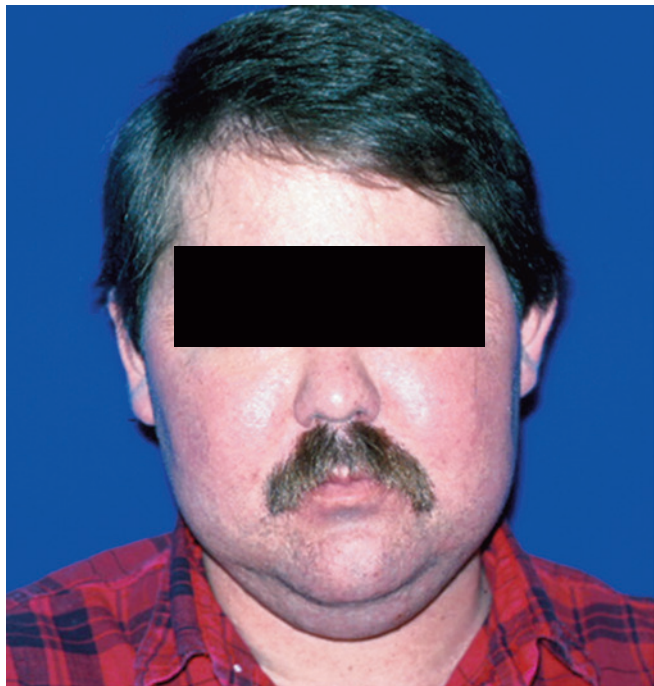

FIG 15.7 “Moon-shaped face,” a clinical manifestation of Cushing disease.

LABORATORY AND DIAGNOSTIC FINDINGS

The presence of adrenal insufficiency is determined by the presence of clinical features together with confirmation that cortisol secretion is inappropriately low. Low concentrations of serum or salivary cortisol in the early morning are strongly suggestive of adrenal insufficiency. This relates to the fact that in the morning the adrenal gland is undergoing maximal secretion of cortisol (range, 10–20 $\mu\text{g/dL}$) compared with late afternoon when values are lower (3–10 $\mu\text{g/dL}$) owing to circadian rhythm. Clinicians also should be aware that cortisol levels vary in response to diet, stress, and sleep pattern.^{30,31}

Pairing the basal cortisol tests with plasma corticotropin concentration or with a provocative stimulation test of the HPA axis aids in the diagnosis. Levels of plasma corticotropin are high with primary adrenal insufficiency and low with secondary adrenal insufficiency.

The most common and reliable provocation test is the standard-dose corticotropin test. It is carried out by injecting 250 μg of exogenous corticotropin intravenously (IV) or intramuscularly (IM), and blood is collected 30 minutes and 60 minutes after injection to determine stimulated cortisol levels. A positive response (i.e., an increase in plasma cortisol level after corticotropin administration) is indicative of adrenal reserve and function. A subnormal test response (60-minute cortisol level <18 ng/mL) is suggestive of adrenal insufficiency but has limited correlation with the patient’s clinical ability to respond to stress.^{32,33}

The insulin tolerance test is used to assess the entire HPA axis when secondary adrenal insufficiency is suspected. This test, however, is unpleasant for the patient because the insulin bolus induces severe hypoglycemia, and constant medical supervision is required during the 2-hour test period.³⁴

Patients with adrenal insufficiency may also experience low aldosterone concentration, hyponatremia, hyperkalemia, hypoglycemia, and high renin levels. Imaging of the adrenal gland and pituitary gland is recommended if malignancy, infiltrative disease, or hemorrhage is suspected.

MEDICAL MANAGEMENT

Primary Adrenal Insufficiency

The primary medical needs of patients with Addison disease are (1) management of the adrenal disease (e.g., elimination of the infectious agent or malignant disease) and (2) lifelong hormone replacement therapy. Glucocorticoid replacement is accomplished at levels that correspond to normal physiologic output of the adrenal cortex, usually about 20 to 25 mg/day of hydrocortisone or cortisone acetate, with a range of 12.5 to 50 mg/day . Current practice recommends that half to two thirds of the dose be given in the morning and one third in the later afternoon in an attempt to reflect the normal diurnal cycle.

Mineralocorticoid replacement is accomplished by single administration of 9 α -fludrocortisone (0.05–0.2 mg) each morning.^{35,36} Patients also are encouraged to ingest adequate sodium and to monitor their blood pressure closely.¹⁷ Although patients with Addison disease can lead essentially normal lives with appropriate treatment, the need for supplemental glucocorticoids during periods of illness, trauma, or stress continues indefinitely. Target dose levels during periods of stress are 25 to 75 mg of hydrocortisone the day of minor to moderate surgery and 100 to 150 mg on the day of major surgery and the day after (Table 15.3).^{37,38} These target doses are based on the cortisol responses elicited by surgery, as explained below.

Surgery causes increased plasma corticosteroid levels during and after operations.⁵ Plasma cortisol levels peak at 2- to 10-fold above baseline between 4 and 10 hours after the operation.^{39,40} The level of response is based on the magnitude of the surgery and whether general anesthesia is used. Postoperative pain is also contributory to elevated cortisol requirements. Kehlet⁴¹ and others estimate that adults secrete 75 to 200 mg a day in response to major surgery and 50 mg a day during minor procedures. Cortisol levels usually return to baseline within 24 to 48 hours of surgery.^{5,37,42,43} Urine levels of cortisol metabolites, however, have been shown to remain increased for 3 to 6 days after the surgery.³⁹

Secondary Adrenal Insufficiency

Secondary adrenal insufficiency results from destructive pituitary disorders. Treatment involves glucocorticoid replacement, albeit at a slightly lower dose than for primary disease. Hydrocortisone dosages of 10 to 20 mg

are generally sufficient, with stress-dose hydrocortisone coverage provided as needed. Mineralocorticoid replacement is not required.

Tertiary Adrenal Insufficiency

Tertiary adrenal insufficiency is a condition resulting from corticosteroids being administered on a chronic basis. Here, the challenge for physicians is to try and balance the beneficial effects of steroids with their unwanted adverse effects. Steroids are prescribed in the management of nonendocrine, inflammatory, and autoimmune disorders for their antiinflammatory and immunosuppressive properties. Selection is based on potency, route of administration, duration of action, and anticipated adverse effects. The goal is to achieve resolution of disease symptoms while minimizing adverse effects.

Depending on the condition, dosages prescribed generally are targeted to be the same as or less than the daily replacement dose of the preparation used. For example, hydrocortisone usually is dispensed at about 20 mg/day, prednisone or prednisolone at 5 mg/day, and dexamethasone at 0.3 to 0.5 mg/day (see Table 15.1). Such regimens given as a morning dose are less suppressive. Higher and divided daily doses are more suppressive and usually take at least 3 weeks to result in clinical manifestation of glucocorticoid deficiency. A method for minimizing the adverse effects of long-term systemic steroid therapy is the *alternate-day regimen*. This method consists of giving steroids in the morning every other day instead of daily but at a higher dose to maintain an elevated serum level. The alternate-day regimen allows the adrenal gland to function normally during the off day and thus does not tend to cause adrenal axis suppression. A *tapered dosage*

TABLE 15.3 Recommendations for Steroid Supplementation During Surgery*

Procedure	Target Dose	
	Primary Adrenal Insufficiency [†]	Secondary Adrenal Insufficiency [‡]
Routine dentistry	None	None
Minor surgery	25 mg of hydrocortisone equivalent, preoperatively on the day of surgery	Daily therapeutic dose
Moderate surgical stress	50–75 mg on day of surgery and up to 1 day after Return to preoperative glucocorticoid dose on postoperative day 2	Daily therapeutic dose
Major surgical stress	100–150 mg per day of hydrocortisone equivalent given for 2–3 days After preoperative dose, 50 mg of hydrocortisone IV every 8 hours after the initial dose for the first 48–72 hours after surgery	Daily therapeutic dose

*Guidelines based on patient's adrenal insufficiency status; however, requirements could increase if the patient's health is poor; if concurrent fear or anxiety, infection that is poorly managed, fever, or cirrhosis is present; and if major surgery or general anesthesia is being performed. Frequent monitoring of blood pressure during the first 8 hours postoperatively is recommended.

[†]Data from Salem M, et al: Perioperative glucocorticoid coverage. A reassessment 42 years after emergence of a problem, *Ann Surg* 219:416-25, 1994.

[‡]Data from Marik PE, Varon J: Requirement of perioperative stress doses of corticosteroids: a systematic review of the literature, *Arch Surg* 143:1222-26, 2008. Supplemental doses can be provided if signs or symptoms of adrenal insufficiency (e.g., hypotension, abdominal pain, fatigue) appear.

IV, Intravenous.

schedule often is implemented for the discontinuation of steroid usage, but this approach may not be necessary in many cases.⁴⁴

The need for additional (i.e., supplemental) corticosteroids for patients taking daily or alternate-day steroids to prevent adrenal crisis during and after surgery has been a concern ever since Fraser and colleagues⁴⁵ reported in 1952 that a patient who had taken cortisone for 8 months experienced refractory hypotension at the end of a routine surgical procedure and died 3 hours later. A similar case was reported a year later.⁴⁶ The general consensus for several decades was that “at-risk” patients who take corticosteroids should be provided supplemental steroids during periods of stress, trauma, or illness.³⁷ More recent evidence, however, has led to revised recommendations (see Table 15.3).

The new recommendations, based on evidence-based reviews, suggest that only patients with primary adrenal insufficiency receive supplemental doses of steroid, and those with secondary adrenal insufficiency who take daily corticosteroids, regardless of the type of surgery, should receive only their usual daily dose of corticosteroid before the surgery.^{47,48} The rationale for these new recommendations is that the vast majority of patients who take daily equivalent or lower doses of steroid (e.g., mean dose of 5–10 mg/day of prednisone) on a long-term basis for conditions such as renal transplantation or rheumatoid arthritis maintain adrenal function and do not experience adverse outcomes after minor or even major surgical procedures.^{44,49–52} In addition, patients who took 5 to 50 mg/day of prednisone for several years who had their glucocorticoid medications discontinued within 1 week before surgery have withstood general surgical procedures without the development of adrenal crisis.^{5,42,50,51} Clinicians should recognize that major surgery generally is performed in hospital-like environments, where close monitoring of blood pressure and fluid balance helps to ensure minimal adverse events during the postsurgical period. Thus, the recommendations listed in Table 15.3 include good operative and postoperative monitoring.

Inasmuch as the recommendations in Table 15.3 serve as guidelines, clinicians should be aware that the need for corticosteroid supplementation also can be influenced by factors that may complicate the postsurgical course and exacerbate adrenal insufficiency. These factors include the overall physical status of the patient, including level of pain, liver dysfunction, febrile illness, sepsis, fluid loss, nausea and vomiting, and drugs taken.^{29,45} Clinicians are advised to monitor the patient for these conditions and to select medications carefully. Drugs that can lower plasma cortisol levels include general anesthetics, midazolam, barbiturates, aminoglutethimide (an adrenolytic), etomidate (an anesthetic agent), ketoconazole, and inducers of hepatic cytochrome P-450 oxygenases (e.g., phenytoin, barbiturates, rifampin) that accelerate degradation of cortisol (see Table 15.2).^{49,53,54} Also of note, the action of oral anticoagulants can be potentiated (resulting in

increased risk of bleeding) by IV administration of high-dose methylprednisolone, which could lead to adrenal hemorrhage.⁵⁵

Adrenal Crisis

Adrenal crisis is a life-threatening emergency that may occur in patients with adrenal insufficiency during stress, an infection, or during or after a surgical procedure. This condition requires timely diagnosis and immediate treatment, including IV injection of a glucocorticoid—usually a 100-mg hydrocortisone bolus—and fluid and electrolyte replacement to reverse the hypotension, cortisol deficiency, and electrolyte abnormalities. IM injection results in slow absorption and is not preferred for emergency treatment. After the initial bolus, 50 mg of hydrocortisone is administered by IV slowly every 6 to 8 hours for 24 hours for a typical total dose of 100 to 200 mg per 24 hours along with fluid replacement, vasopressors, continuous infusion of saline, and correction of hypoglycemia, if needed. Resolution of the precipitating event or condition also is required.

DENTAL MANAGEMENT

Identification. Any patient whose condition remains undiagnosed but who has cardinal signs and symptoms of adrenal disease should be referred to a physician for diagnosis and treatment. Laboratory testing and diagnostic imaging are helpful in identifying those who may have adrenal insufficiency.

Risk Assessment. Risk assessment for primary or secondary adrenal insufficiency should be determined by performing a thorough medical history, physical examination, and, if needed, laboratory tests and medical consultation. The dentist should be aware that a past or present history of tuberculosis, histoplasmosis, or HIV infection increases the risk for primary adrenal disease (insufficiency) because opportunistic infectious agents may attack the adrenal glands. In addition, adrenal crisis is more likely in patients with adrenal insufficiency who have the following comorbidities: malignancy, major traumatic injury, severe pain, infection or sepsis, liver cirrhosis, administration of medications that alter cortisol metabolism or production, recent emergency or hospitalization visits, or need for stress-related corticoid dose self-adjustments. In general, patients with tertiary adrenal insufficiency are at low risk for adrenal crisis unless they receive an invasive procedure and have one of the above-mentioned comorbidities in combination with recently discontinued high-dose corticosteroid treatment, simply do not take their glucocorticoid before a stressful surgical procedure, or present with low blood pressure before an invasive procedure. If the dentist is uncertain of the functional reserve of the patient, laboratory testing and medical consultation are advised before the performance of an invasive or prolonged (>1 hour) procedure.

Recommendations. In developing recommendations for dental patients with adrenal disease, the dentist must consider the type and degree of adrenal dysfunction and the dental procedure planned.

Hyperadrenalism. Patients with hyperadrenalism or who take corticosteroids for prolonged periods have an increased likelihood of having hypertension, diabetes, delayed wound healing, osteoporosis, and peptic ulcer disease. To minimize the risk of an adverse outcome, blood pressure should be taken at baseline and monitored during dental appointments. Blood glucose levels should be determined, and invasive procedures should be performed during periods of good glucose control. Follow-up appointments should be arranged to assess proper wound healing. Because osteoporosis has a relationship with periodontal bone loss, implant placement, and bone fracture, periodic measures of periodontal bone loss are indicated. Also, measures should be instituted that promote bone mineralization, and extensive neck manipulation should be avoided if osteoporosis is severe. Because of the risk of peptic ulceration, postoperative analgesics for long-term steroid users should not include aspirin and other nonsteroidal antiinflammatory drugs.

Adrenal Insufficiency

Antibiotics: Risk of Infection. No issues.

Bleeding. Generally, this is not an issue. An exception is patients who take heparin or an other anticoagulant, which places them at increased risk for adrenal hemorrhage, postsurgical bleeding, and hypotension.

Blood Pressure. Monitoring of blood pressure throughout invasive dental procedures of patients who have adrenal insufficiency is critical for recognition of a developing adrenal crisis. During surgery, blood pressure should be evaluated at 5-minute intervals and before the patient leaves the office. A systolic blood pressure below 100 mm Hg or a diastolic pressure at or below 60 mm Hg represents hypotension. A diagnosis of hypotension dictates that the clinician must take corrective action. This includes proper patient positioning (i.e., head lower than feet), fluid replacement, administration of vasopressors, and evaluation for signs of adrenal dysfunction versus hypoglycemia. If adrenal crisis is determined to be occurring, a steroid bolus is required.

Capacity to Tolerate Care. This patient population is potentially at risk for an adrenal crisis. The risk is highest in those with primary adrenal insufficiency, especially those who are undiagnosed or untreated. In one study, 8% of patients with Addison disease needed hospital treatment annually for an adrenal crisis.⁵⁶ In contrast, patients who have secondary or tertiary adrenal insufficiency are at much lower risk. In fact, evidence indicates that the vast majority of patients with secondary or tertiary adrenal insufficiency may undergo routine dental treatment without the need for supplemental glucocorticoids.^{40,42,51,52,57} Patients at risk for adrenal crisis are those who have a fever, intercurrent illness, or sustained trauma or who

are undergoing stressful surgical procedures or general anesthesia and have no, or extremely low, adrenal function because of primary or severe secondary adrenal insufficiency.⁵⁸ It is recommended to delay treatment for these patients and any patient who is undiagnosed or untreated until the patient has been medically stabilized.

Dentists should be aware that three factors influence the recommendation for supplemental corticosteroids: (1) type of adrenal insufficiency, (2) medical status and stability, and (3) level and type of stress.⁵⁹ Currently, only patients with primary adrenal insufficiency are recommended to receive corticosteroid supplementation, and this recommendation applies only when surgery or general anesthesia is being performed or in the management of a dental or systemic infection (see [Table 15.3](#)).^{47,50,57,60-64} Patients with well-controlled secondary adrenal insufficiency and those who take daily or alternate-day corticosteroids generally have enough exogenous and endogenous cortisol to handle routine dental procedures and surgery if their usual steroid dose (or parenteral dose equivalent) is taken the morning of the procedure.⁴⁷ Thus, the recommendation is for patients to take their usual daily dose of steroid within 2 hours of the surgical procedure and that the surgeon, anesthetist, and nurses be advised of possible complications associated with the patient's adrenal state. Routine dental procedures do not stimulate cortisol production at levels comparable with those that occur during and after surgery and do not require supplementation, even in patients with controlled primary adrenal insufficiency.^{57,65} Patients undergoing surgery should be closely monitored for blood and fluid loss and for hypotension during the postoperative period. If hypotension appears during monitoring, IV fluids are to be given and additional doses of corticosteroid considered if fluid replacement fails to rectify the blood pressure. Patients are returned to their usual glucocorticoid dosage as soon as their vital signs are stabilized.

Additional measures recommended to minimize the risk of adrenal crisis associated with surgical stress are shown in [Box 15.1](#). Surgery should be scheduled in the morning when cortisol levels are highest. Proper stress reduction should be provided because fear and anxiety increase cortisol demand. Nitrous oxide–oxygen inhalation and benzodiazepine sedation^{7,66} are helpful in minimizing stress and reducing cortisol demand.³⁹ In contrast, reversal of and recovery from general anesthesia and extubation, and not the trauma of surgery itself, are major determinants of secretion of ACTH, cortisol, and epinephrine.^{66,67} Thus, general anesthesia increases glucocorticoid demand for these patients. Barbiturates also should be used cautiously because these drugs enhance the metabolism of cortisol and reduce blood levels of cortisol.^{54,68,69} In addition, inhibitors of corticosteroid production (see [Table 15.2](#)) should be discontinued at least 24 hours before surgery, with the consent of the patient's physician.

Surgeries that last longer than 1 hour are more stressful than shorter surgeries and should be considered major

BOX 15.1 Dental Management Considerations in Patients With Possible Adrenal Insufficiency*

P		D	
Patient Evaluation and Risk Assessment (see Box 1.1)		Devices	No issues
<ul style="list-style-type: none"> Evaluate and determine whether primary adrenal sufficiency or secondary adrenal insufficiency exists. Obtain medical consultation if condition is poorly controlled (e.g., acute infection), if clinical signs and symptoms point to an undiagnosed problem, or if diagnosis is uncertain. 		Drugs	Provide steroid supplementation for primary adrenal insufficiency during surgical procedures or infection (see Table 15.2). Provide usual morning corticosteroid dose for patients who have secondary adrenal insufficiency and are undergoing surgical procedures. Avoid phenobarbital use because it increases the metabolism of cortisol and reduces blood levels of cortisol. Also, discontinue use of phenytoin, rifampicin, troglitazone (inducers of cortisol metabolism), ketoconazole, fluconazole, etomidate, metyrapone, and aminoglutethimide (inhibitors of corticosteroid production) at least 24 hours before surgery, with the consent of the patient's physician.
Potential Issues and Factors of Concern		E	
A		Equipment	Have an emergency medical kit readily available.
Analgesics	Provide good postoperative pain control to avoid adrenal crisis.	Emergencies	Acute adrenal crisis is a medical emergency. Call 911. Apply cool wet or ice packs, assess and monitor vital signs, start IV saline solution, inject 100 IV of hydrocortisone followed by 100–200 mg of hydrocortisone in 5% glucose by continuous IV infusion, and transport patient to emergency medical facility.
Antibiotics	No issues	F	
Anesthesia	Provide adequate operative and postoperative anesthesia; routine use of epinephrine (1:100,000) is appropriate. Consider using long-acting local anesthetics (e.g., bupivacaine) at the end of the procedure to provide longer postoperative pain control. General anesthesia increases glucocorticoid demand and could render an adrenal-insufficient patient susceptible to adrenal crisis; therefore, use cautiously.	Follow-up	Adrenal-insufficient patients should be monitored for good fluid balance and adequate blood pressure during the first 24 hours postsurgery. Communicate with the patient at the end of the appointment and within 4 hours postoperatively to determine whether features of weak pulse, hypotension, dyspnea, myalgias, arthralgia, ileus, and fever are present. Signs and symptoms of adrenal crisis dictate transport to a hospital for emergency care.
Anxiety	Anxiety and stress increase the risk of adrenal crisis if adrenal insufficiency is present. Use anxiety and stress reduction techniques as needed.		
B			
Bleeding	Minimize blood loss.		
Blood pressure	Continuously monitor blood pressure throughout stressful and invasive procedures. Postoperative monitoring for at least 8 hours is recommended for procedures involving moderate or major surgery. If blood pressure drops below 100/60 mm Hg, consider fluid replacement, vasopressive measures, and supplemental steroid administration, as needed.		
C			
Capacity to tolerate care	Provide adequate supplemental corticosteroids according to Table 15.2.		
Chair position	Hypotension (e.g., from severe adrenal insufficiency) may dictate a supine position. Otherwise, normal chair position can be used.		

*Surgical procedures lasting longer than 1 hour are more stressful than shorter procedures and are considered major surgery. Major surgery should be performed with the consideration for the need of steroid supplementation based on the overall health status of the patient. In addition, inadequate pain and anxiety control in the perioperative period increase the risk of adrenal crisis. Performance of major surgical procedures in a hospital environment is recommended to afford adequate patient monitoring during the postoperative phase. IV, Intravenous.

surgical procedures that can require the need for steroid supplementation. Blood and fluid volume loss exacerbate hypotension, thereby increasing the risk for development of adrenal insufficiency–like symptoms. Thus, methods that reduce blood loss are important in this setting.

Likewise, a fasting state can contribute to hypoglycemia, which can mimic features of an adrenal crisis but does not require glucocorticoids for resolution.

Drug Considerations and Interactions. Inadequate pain control during the postoperative period increases the risk

of adrenal crisis. Clinicians should provide good postoperative pain control by means of long-acting local anesthetics (e.g., bupivacaine) given at the end of the procedure. Inasmuch as significant increases in cortisol levels generally are not seen before or during the operation but are increased in the postoperative period (i.e., 1–5 hours after the procedure commensurate with the pain response)^{40,50,61,70} and the rise in cortisol levels is blunted by the use of analgesics and midazolam,^{7,40} good pain control with local anesthesia and analgesics is recommended for these patients.

Emergency Action. Immediate treatment during an adrenal crisis requires proper patient positioning (i.e., head lower than feet), fluid replacement, administration of vasopressors, administration of 100 mg of hydrocortisone or 4 mg of dexamethasone IV, and immediate transportation to a medical facility.

Oral Manifestations

Diffuse or focal brown macular pigmentation of the oral mucous membranes is a common finding in primary adrenal insufficiency (see Fig. 15.6). Pigmentation of sun-exposed skin in areas of friction generally occurs after the appearance of oral pigmentation and is accompanied by lethargy.⁷¹ Patients with secondary or tertiary adrenal insufficiency may be prone to delayed healing and may have increased susceptibility to infection but do not develop hyperpigmentation.

REFERENCES

1. Stewart PM, Newell-Price JDC. The adrenal cortex. In: Melmed S, Polonsky KS, Larsen R, et al, eds. *Williams Textbook of Endocrinology*. Philadelphia: Elsevier; 2016.
2. Collins S, Caron MG, Lefkowitz RJ. Beta-adrenergic receptors in hamster smooth muscle cells are transcriptionally regulated by glucocorticoids. *J Biol Chem*. 1988;263(19):9067-9070.
3. Annetta M, Maviglia R, Proietti R, et al. Use of corticosteroids in critically ill septic patients: a review of mechanisms of adrenal insufficiency in sepsis and treatment. *Curr Drug Targets*. 2009;10(9):887-894.
4. Reisch N, Arlt W. Fine tuning for quality of life: 21st century approach to treatment of Addison's disease. *Endocrinol Metab Clin North Am*. 2009;38(2):407-418, ix-x.
5. Chernow B, Alexander HR, Smallridge RC, et al. Hormonal responses to graded surgical stress. *Arch Intern Med*. 1987;147(7):1273-1278.
6. Cooper MS, Stewart PM. Corticosteroid insufficiency in acutely ill patients. *N Engl J Med*. 2003;348(8):727-734.
7. Jerjes W, Jerjes WK, Swinson B, et al. Midazolam in the reduction of surgical stress: a randomized clinical trial. *Oral Surg Oral Med Oral Pathol Oral Radiol Endod*. 2005;100(5):564-570.
8. George JM, Reier CE, Lanese RR, et al. Morphine anesthesia blocks cortisol and growth hormone response to surgical stress in humans. *J Clin Endocrinol Metab*. 1974;38(5):736-741.
9. Raff H, Norton AJ, Flemma RJ, et al. Inhibition of the adrenocorticotropin response to surgery in humans: interaction between dexamethasone and fentanyl. *J Clin Endocrinol Metab*. 1987;65(2):295-298.
10. Gersema L, Baker K. Use of corticosteroids in oral surgery. *J Oral Maxillofac Surg*. 1992;50(3):270-277.
11. Kaufman E, Heling I, Rotstein I, et al. Intraligamentary injection of slow-release methylprednisolone for the prevention of pain after endodontic treatment. *Oral Surg Oral Med Oral Pathol*. 1994;77(6):651-654.
12. Nieman L, Swearingen B. Cushing's Syndrome and Cushing's Disease: 2013 Update; 2013. In: Society TP, editor. (Available at): https://pituitarysociety.org/sites/all/pdfs/Pituitary_Society_Cushings_brochure.pdf: SMM Global.
13. Charmandari E, Nicolaidis NC, Chrousos GP. Adrenal insufficiency. *Lancet*. 2014;383(9935):2152-2167.
14. Lovas K, Husebye ES. High prevalence and increasing incidence of Addison's disease in western Norway. *Clin Endocrinol (Oxf)*. 2002;56(6):787-791.
15. Erichsen MM, Lovas K, Skinningsrud B, et al. Clinical, immunological, and genetic features of autoimmune primary adrenal insufficiency: observations from a Norwegian registry. *J Clin Endocrinol Metab*. 2009;94(12):4882-4890.
16. Willis AC, Vince FP. The prevalence of Addison's disease in Coventry, UK. *Postgrad Med J*. 1997;73(859):286-288.
17. Arlt W, Allolio B. Adrenal insufficiency. *Lancet*. 2003;361(9372):1881-1893.
18. Tomlinson JW, Holden N, Hills RK, et al. Association between premature mortality and hypopituitarism. West Midlands Prospective Hypopituitary Study Group. *Lancet*. 2001;357(9254):425-431.
19. Bergthorsdottir R, Leonsson-Zachrisson M, Oden A, et al. Premature mortality in patients with Addison's disease: a population-based study. *J Clin Endocrinol Metab*. 2006;91(12):4849-4853.
20. Mandanas S, Boudina M, Chrisoulidou A, et al. Acute adrenal insufficiency following arthroplasty: a case report and review of the literature. *BMC Res Notes*. 2013;6:370.
21. Hameed R, Zacharin MR. Cushing syndrome, adrenal suppression and local corticosteroid use. *J Paediatr Child Health*. 2006;42(6):392-394.
22. Coskey RJ. Adverse effects of corticosteroids: I. Topical and intralesional. *Clin Dermatol*. 1986;4(1):155-160.
23. Patel L, Clayton PE, Addison GM, et al. Adrenal function following topical steroid treatment in children with atopic dermatitis. *Br J Dermatol*. 1995;132(6):950-955.
24. Plemons JM, Rees TD, Zachariah NY. Absorption of a topical steroid and evaluation of adrenal suppression in patients with erosive lichen planus. *Oral Surg Oral Med Oral Pathol*. 1990;69(6):688-693.
25. Molimard M, Girodet PO, Pollet C, et al. Inhaled corticosteroids and adrenal insufficiency: prevalence and clinical presentation. *Drug Saf*. 2008;31(9):769-774.
26. Kelly HW, Nelson HS. Potential adverse effects of the inhaled corticosteroids. *J Allergy Clin Immunol*. 2003;112(3):469-478, quiz 79.

27. Glick M. Glucocorticosteroid replacement therapy: a literature review and suggested replacement therapy. *Oral Surg Oral Med Oral Pathol.* 1989;67(5):614-620.
28. Hahner S, Loeffler M, Bleicken B, et al. Epidemiology of adrenal crisis in chronic adrenal insufficiency: the need for new prevention strategies. *Eur J Endocrinol.* 2010;162(3):597-602.
29. Puar TH, Stikkelbroeck NM, Smans LC, et al. Adrenal crisis: still a deadly event in the 21(st) century. *Am J Med.* 2016;129(3):339 e1-339 e9.
30. Findling JW, Raff H. Screening and diagnosis of Cushing's syndrome. *Endocrinol Metab Clin North Am.* 2005;34(2):385-402, ix-x.
31. Wallace I, Cunningham S, Lindsay J. The diagnosis and investigation of adrenal insufficiency in adults. *Ann Clin Biochem.* 2009;46(Pt 5):351-367.
32. Dorin RI, Qualls CR, Crapo LM. Diagnosis of adrenal insufficiency. *Ann Intern Med.* 2003;139(3):194-204.
33. Marik PE, Pastores SM, Annane D, et al. Recommendations for the diagnosis and management of corticosteroid insufficiency in critically ill adult patients: consensus statements from an international task force by the American College of Critical Care Medicine. *Crit Care Med.* 2008;36(6):1937-1949.
34. Grinspoon SK, Biller BM. Clinical review 62: laboratory assessment of adrenal insufficiency. *J Clin Endocrinol Metab.* 1994;79(4):923-931.
35. Lovas K, Husebye ES. Replacement therapy for Addison's disease: recent developments. *Expert Opin Investig Drugs.* 2008;17(4):497-509.
36. Falorni A, Minarelli V, Morelli S. Therapy of adrenal insufficiency: an update. *Endocrine.* 2013;43(3):514-528.
37. Salem M, Tainsh RE Jr, Bromberg J, et al. Perioperative glucocorticoid coverage. A reassessment 42 years after emergence of a problem. *Ann Surg.* 1994;219(4):416-425.
38. Jung C, Inder WJ. Management of adrenal insufficiency during the stress of medical illness and surgery. *Med J Aust.* 2008;188(7):409-413.
39. Thomasson B. Studies on the content of 17-hydroxycorticosteroids and its diurnal rhythm in the plasma of surgical patients. *Scand J Clin Lab Invest.* 1959;11(suppl 42):1-180.
40. Banks P. The adreno-cortical response to oral surgery. *Br J Oral Surg.* 1970;8(1):32-44.
41. Kehlet H. *Clinical Course and Hypothalamic-Pituitary-Adrenocortical Function in Glucocorticoid-Treated SURGICAL patients.* Copenhagen: FADL's Forlag; 1976.
42. Kehlet H, Binder C. Adrenocortical function and clinical course during and after surgery in unsupplemented glucocorticoid-treated patients. *Br J Anaesth.* 1973;45(10):1043-1048.
43. Udelsman R, Holbrook NJ. Endocrine and molecular responses to surgical stress. *Curr Probl Surg.* 1994;31(8):653-720.
44. Shapiro R, Carroll PB, Tzakis AG, et al. Adrenal reserve in renal transplant recipients with cyclosporine, azathioprine, and prednisone immunosuppression. *Transplantation.* 1990;49(5):1011-1013.
45. Fraser CG, Preuss FS, Bigford WD. Adrenal atrophy and irreversible shock associated with cortisone therapy. *J Am Med Assoc.* 1952;149(17):1542-1543.
46. Lewis L, Robinson RF, Yee J, et al. Fatal adrenal cortical insufficiency precipitated by surgery during prolonged continuous cortisone treatment. *Ann Intern Med.* 1953;39(1):116-126.
47. Marik PE, Varon J. Requirement of perioperative stress doses of corticosteroids: a systematic review of the literature. *Arch Surg.* 2008;143(12):1222-1226.
48. Yong SL, Coulthard P, Wrzosek A. Supplemental perioperative steroids for surgical patients with adrenal insufficiency. *Cochrane Database Syst Rev.* 2012;(12):CD005367.
49. Jasani MK, Freeman PA, Boyle JA, et al. Cardiovascular and plasma cortisol responses to surgery in corticosteroid-treated R. A. patients. *Acta Rheumatol Scand.* 1968;14(1):65-70.
50. Plumpton FS, Besser GM, Cole PV. Corticosteroid treatment and surgery. 2. The management of steroid cover. *Anaesthesia.* 1969;24(1):12-18.
51. Bromberg JS, Baliga P, Cofer JB, et al. Stress steroids are not required for patients receiving a renal allograft and undergoing operation. *J Am Coll Surg.* 1995;180(5):532-536.
52. Friedman RJ, Schiff CF, Bromberg JS. Use of supplemental steroids in patients having orthopaedic operations. *J Bone Joint Surg Am.* 1995;77(12):1801-1806.
53. Lehtinen AM, Hovorka J, Widholm O. Modification of aspects of the endocrine response to tracheal intubation by lignocaine, halothane and thiopentone. *Br J Anaesth.* 1984;56(3):239-246.
54. Oyama T, Takiguchi M, Aoki N, et al. Adrenocortical function related to thiopental-nitrous oxide-oxygen anesthesia and surgery in man. *Anesth Analg.* 1971;50(5):727-731.
55. Costedoat-Chalumeau N, Amoura Z, Aymard G, et al. Potentiation of vitamin K antagonists by high-dose intravenous methylprednisolone. *Ann Intern Med.* 2000;132(8):631-635.
56. White K, Arlt W. Adrenal crisis in treated Addison's disease: a predictable but under-managed event. *Eur J Endocrinol.* 2010;162(1):115-120.
57. Miller CS, Little JW, Falace DA. Supplemental corticosteroids for dental patients with adrenal insufficiency: reconsideration of the problem. *J Am Dent Assoc.* 2001;132(11):1570-1579, quiz 96-7.
58. Hannig KE, Poulsen PL, Tonnesen EK, et al. [Recommendations for supplementary intravenous glucocorticosteroids in patients on long-term steroid therapy—a systematic review]. *Ugeskr Laeger.* 2012;174(50):3155-3159.
59. Khalaf MW, Khader R, Cobetto G, et al. Risk of adrenal crisis in dental patients: results of a systematic search of the literature. *J Am Dent Assoc.* 2013;144(2):152-160.
60. Milenkovic A, Markovic D, Zdravkovic D, et al. Adrenal crisis provoked by dental infection: case report and review of the literature. *Oral Surg Oral Med Oral Pathol Oral Radiol Endod.* 2010;110(3):325-329.

61. Ziccardi VB, Abubaker AO, Sotereanos GC, et al. Precipitation of an Addisonian crisis during dental surgery: recognition and management. *Compendium*. 1992;13(6):518. 20, 22-4.
62. Broutsas MG, Seldin R. Adrenal crisis after tooth extractions in an adrenalectomized patient: report of case. *J Oral Surg*. 1972;30(4):301-302.
63. Cawson RA, James J. Adrenal crisis in a dental patient having systemic corticosteroids. *Br J Oral Surg*. 1973;10(3):305-309.
64. Scheitler LE, Tucker WM, Christian DC. Adrenal insufficiency: report of case. *Spec Care Dentist*. 1984;4(1):22-24.
65. Miller CS, Dembo JB, Falace DA, et al. Salivary cortisol response to dental treatment of varying stress. *Oral Surg Oral Med Oral Pathol Oral Radiol Endod*. 1995;79(4):436-441.
66. Hempenstall PD, Campbell JP, Bajurnow AT, et al. Cardiovascular, biochemical, and hormonal responses to intravenous sedation with local analgesia versus general anesthesia in patients undergoing oral surgery. *J Oral Maxillofac Surg*. 1986;44(6):441-446.
67. Udelsman R, Norton JA, Jelenich SE, et al. Responses of the hypothalamic-pituitary-adrenal and renin-angiotensin axes and the sympathetic system during controlled surgical and anesthetic stress. *J Clin Endocrinol Metab*. 1987;64(5):986-994.
68. Parnell AG. Adrenal crisis and the dental surgeon. *Br Dent J*. 1964;116:294-298.
69. Siker ES, Lipschitz E, Klein R. The effect of preanesthetic medications on the blood level of 17-hydroxycorticosteroids. *Ann Surg*. 1956;143(1):88-91.
70. Shannon IL, Isbell GM, Prigmore JR, et al. Stress in dental patients. II. The serum free 17-hydroxycorticosteroid response in routinely appointed patients undergoing simple exodontia. *Oral Surg Oral Med Oral Pathol*. 1962;15:1142-1146.
71. Nieman LK, Chanco Turner ML. Addison's disease. *Clin Dermatol*. 2006;24(4):276-280.

Thyroid Diseases

DEFINITION

Thyroid disease in a patient who presents for dental treatment is a cause for concern on several fronts. Undiagnosed or poorly controlled thyroid disorders can be expected to compromise outcomes with otherwise perfectly appropriate dental management plans. Detection of early signs and symptoms of such disorders during the dentist's head and neck evaluation can lead to referral of the patient for medical evaluation and treatment. In some instances, such intervention may be lifesaving, and in others, quality of life can be improved and complications of certain thyroid disorders avoided, particularly in the context of delivery of dental care.

This chapter focuses on disorders involving hyperfunction of the gland (hyperthyroidism or thyrotoxicosis), hypofunction of the gland (hypothyroidism, myxedema, or congenital hypothyroidism), thyroiditis, and the detection of lesions that may be cancerous (Table 16.1).¹⁻⁴

COMPLICATIONS

Patients with poorly controlled thyroid disease can experience complications. Patients with hyperthyroidism are predisposed to adverse interaction with epinephrine, life-threatening cardiac arrhythmias, congestive heart failure (CHF), and thyrotoxic crisis (thyroid storm, precipitated by infection or surgical procedures). Complications that may occur in patients with hypothyroidism are an exaggerated response to central nervous system (CNS) depressants (sedatives and narcotic analgesics) and myxedematous coma precipitated by CNS depressants, infection, or surgical procedures.^{2,5-8}

THYROID GLAND

The thyroid gland, located in the anterior portion of the neck just below and bilateral to the thyroid cartilage, develops from the thyroglossal duct and portions of the ultimobranchial body^{9,10} (Fig. 16.1). It consists of two lateral lobes connected by an isthmus. A superior portion of glandular tissue, or a pyramidal lobe, can be identified. Thyroid tissue may be found anywhere along the path of the thyroglossal duct, from its origin (midline posterior portion of the tongue) to its termination (thyroid gland, in the neck).⁹⁻¹² In rare cases, the entire thyroid lies within the anterior mediastinal compartment; in most people,

however, remnants of the duct atrophy and disappear.^{9,11,12} The thyroglossal duct passes through the region of the developing hyoid bone, and remnants of the duct may become enclosed or surrounded by bone.¹⁰ Ectopic thyroid tissue may secrete thyroid hormones or may become cystic (Fig. 16.2) or neoplastic.^{10,12,13} In a few people, the only functional thyroid tissue is found in these ectopic locations.^{10,12}

The parathyroid glands develop from the third and fourth pharyngeal pouches and become embedded within the thyroid gland.¹⁴ Neural crest cells from the ultimobranchial body give rise to thyroid medullary C cells, which produce calcitonin, a calcium-lowering hormone. These C cells are found throughout the thyroid gland.^{12,15}

ENLARGEMENT AND NODULES OF THE THYROID GLAND

Generalized enlargement of the thyroid gland, referred to as a *goiter*, may be diffuse (Fig. 16.3) or nodular (Fig. 16.4), and a goiter may be functional or nonfunctional.^{11,16-18}

On a functional basis, thyroid enlargement can be divided into three types: primary goiter (simple goiter and

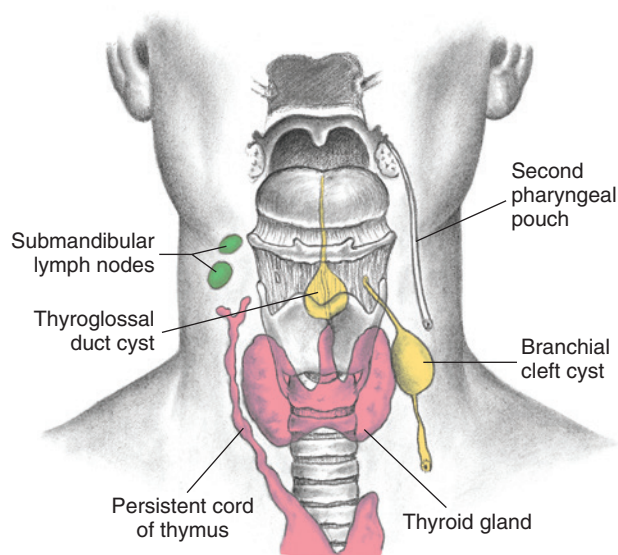

FIG 16.1 Thyroglossal duct cyst and branchial cleft cyst development. (From Seidel HM, et al: *Mosby's guide to physical examination*, ed 7, St. Louis, 2011, Mosby.)

TABLE 16.1 Causes of Thyroid Conditions

Thyroid Condition	Causes
Hyperthyroidism	Primary thyroid hyperfunction <ul style="list-style-type: none"> • Graves disease • Toxic multinodular goiter • Toxic adenoma Secondary thyroid hyperfunction <ul style="list-style-type: none"> • Pituitary adenoma—TSH secretion • Inappropriate TSH secretion (pituitary) • Trophoblastic hCG secretion Without thyroid hyperfunction <ul style="list-style-type: none"> • Hormonal leakage—subacute thyroiditis • Thyroid hormone use (factitia) • Bovine thyroid in ground beef • Metastatic thyroid cancer
Hypothyroidism (cretinism, myxedema)	Primary atrophic hypothyroidism <ul style="list-style-type: none"> • Insufficient amount of thyroid tissue <ul style="list-style-type: none"> • Destruction of tissue by autoimmune process: Hashimoto thyroiditis (atrophic and goitrous), Graves disease—end stage • Destruction of tissue by iatrogenic procedures: ¹³¹I therapy, surgical thyroidectomy, external radiation to thyroid gland • Destruction of tissue by infiltrative process: amyloidosis, lymphoma, scleroderma • Defects of thyroid hormone biosynthesis <ul style="list-style-type: none"> • Congenital enzyme defects • Congenital mutations in TSH receptor • Iodine deficiency or excess • Drug-induced: thionamides, lithium, others • Agenesis or dysplasia Secondary hypothyroidism <ul style="list-style-type: none"> • Pituitary <ul style="list-style-type: none"> • Panhypopituitarism (neoplasm, irradiation, surgery) • Isolated TSH deficiency • Hypothalamic <ul style="list-style-type: none"> • Congenital • Infection • Infiltration (sarcoidosis, granulomas) Transient hypothyroidism <ul style="list-style-type: none"> • Silent and subacute thyroiditis • Thyroxine withdrawal Generalized resistance to thyroid hormone
Thyroiditis	Acute suppurative Subacute painful Subacute painless Hashimoto Chronic fibrosing (Riedel)
Thyroid neoplasms	Adenomas Carcinomas Others

hCG, Human chorionic gonadotropin; *TSH*, thyroid-stimulating hormone.

thyroid cancer), thyrostimulatory secondary goiters (Graves disease and congenital hereditary goiter), and thyroinvasive secondary goiters (Hashimoto thyroiditis, subacute painful thyroiditis, Riedel thyroiditis, and metastatic tumors to the thyroid). Simple goiter accounts for about 75% of all thyroid swellings.¹⁶ Most of these goiters are non-functional, and thyroid function is normal. The goiter of Graves disease is associated with hyperthyroidism.^{11,16}

Hashimoto thyroiditis leads to hypothyroidism and thyroid enlargement.^{16,19} By contrast, patients with enlargement caused by subacute thyroiditis experience a transient period of hyperthyroidism.¹⁶ Nodules found in the thyroid may be hyperplastic nodules, adenomas, or carcinomas. Hyperplastic nodules and adenomas can be functional (Fig. 16.5) or nonfunctional. Most carcinomas are nonfunctional.^{11,16,20,21} Thyroid cancer most often manifests as a single nodule but



FIG 16.2 Thyroglossal duct cyst.



FIG 16.3 Diffuse enlargement of the thyroid gland caused by Graves disease (goiter).

can arise as multiple lesions or, in rare cases, can occur within a benign goiter.^{11,16,20,21}

FUNCTION OF THE THYROID GLAND

The thyroid gland secretes three hormones: thyroxine (T_4), triiodothyronine (T_3), and calcitonin.^{17,22,23} T_3 and T_4 collectively are termed *thyroid hormone*. Thyroid hormone influences the growth and maturation of tissues, cell respiration, and total energy expenditure. This hormone is involved in the turnover of essentially all substances, vitamins, and hormones.^{8,17,22-24}

Most thyroid actions (metabolic and developmental) are mediated through activity of nuclear receptors that are tissue site specific.^{17,25} Thyroid receptors work by altering gene expression in response to changes in thyroid hormone concentrations (mostly T_3). This alteration in gene transcription profile is believed to account for most of the observed physiologic effects of thyroid hormones, although there are also actions of thyroid hormones that do not involve transcription.²³ Thyroid hormone increases



FIG 16.4 Multinodular goiter. (From Swartz MH: *Textbook of physical diagnosis: history and examination*, ed 6, Philadelphia, 2010, Saunders.)

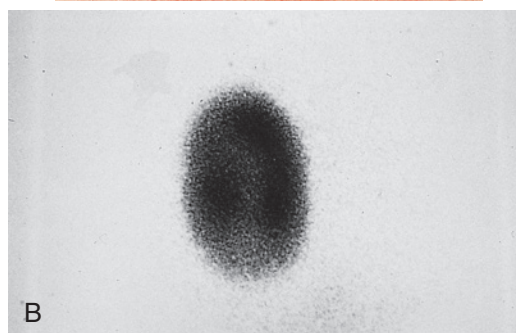

FIG 16.5 A, Toxic adenoma of the thyroid gland causing hyperthyroidism. **B**, Toxic adenoma in the right thyroid demonstrated with the use of technetium-pertechnetate scanning. (From Forbes CD, Jackson WF: *Color atlas and text of clinical medicine*, ed 3, Edinburgh, 2003, Mosby.)

oxygen consumption, thermogenesis, and expression of the low-density lipoprotein (LDL) receptor, resulting in accelerated LDL cholesterol degradation. In myocardium, T_3 increases myocyte contractility and relaxation by altering myosin heavy chain and sarcoplasmic reticulum adenosine triphosphatase (ATPase). In the cardiac conducting system, T_3 increases the heart rate by altering sinoatrial node depolarization and repolarization. Other physiologic effects of thyroid hormone include increased mental alertness, ventilatory drive, gastrointestinal motility, and bone turnover. During fetal development, thyroid hormone plays a critical role in brain development and skeletal maturation.^{11,24}

Calcitonin is involved, along with parathyroid hormone and vitamin D, in regulating serum calcium and phosphorus levels and skeletal remodeling. (This hormone and its actions are considered further in Chapter 12.^{17,22,23})

Epidemiology

About 12% of the U.S. population will develop a thyroid disorder during their lifetimes. Graves disease, the most common cause of hyperthyroidism in the United States, occurs in up to 2% of women and 0.2% of men. It is rare before adolescence, usually affecting persons from the late teens to the 40s, although it does occur in older adults.^{5,8,16,24,26}

Congenital hypothyroidism is present in about 1 in 4000 newborns. Most cases (80%–85%) are caused by thyroid gland dysgenesis, which is twice as common in girls. The annual incidence rates of autoimmune hypothyroidism are 4 cases per 1000 women and 1 per 1000 men. The prevalence increases with age, and the mean age at diagnosis is 60 years. Subclinical hypothyroidism is diagnosed in 6% to 8% of women (10% in women older than 60 years of age) and 3% of men.^{27,28}

Subacute painful thyroiditis accounts for 5% of all medical consultations regarding thyroid disorders and is three times more common in women than men. Subacute painless thyroiditis occurs in patients with underlying autoimmune thyroid disease and is reported in up to 5% of women 3 to 6 months after pregnancy. In these circumstances, it is called *postpartum thyroiditis*. Riedel thyroiditis is a rare form of chronic thyroiditis that typically occurs in middle-aged women. Acute suppurative thyroiditis is rare.^{11,16,26,28,29}

Thyroid nodules can be found in about 5% of the adult population in the United States.^{11,16,20} The frequency of cancer in solitary thyroid nodules has been reported to be about 1% to 5%.^{11,16,20} During the past decade, the incidence of thyroid cancer has increased at a rate of about 5% per year.^{20,30,31} For 2015, the National Cancer Institute estimated a total of 62,450 new cases of thyroid cancer, with about 1950 deaths.³¹ The 5-year survival rate for thyroid cancer is 97%.³¹ In an average dental practice of 2000 patients, an estimated 20 to 150 patients will have some form of thyroid disease.

Etiology

Table 16.1 lists the many causes of thyroid disease. The four main categories are hyperfunction, hypofunction, thyroiditis, and neoplasia. Each can affect the amounts of circulating thyroid hormone and the quality of life of the affected person.^{8,19,21,32}

Dentists should be aware that blood levels of T_4 and T_3 are controlled through a servofeedback mechanism mediated by the hypothalamic–pituitary–thyroid axis (Fig. 16.6). Increased or decreased metabolic demand appears to be the main modifier of the system. Drugs, illness, thyroid disease, pituitary disorders, and age may affect control of this balance.^{16,17,23,33} Under normal conditions, thyrotropin-releasing hormone (TRH) is released by the hypothalamus in response to external stimuli (e.g., stress; illness; metabolic demand; low levels of T_3 and, to a lesser extent, T_4). TRH stimulates the pituitary to release thyroid-stimulating hormone (TSH), which causes the thyroid gland to secrete T_4 and T_3 . T_4 and T_3 also have a direct influence on the pituitary. High levels turn off the release of TSH, and low levels turn it on. In the

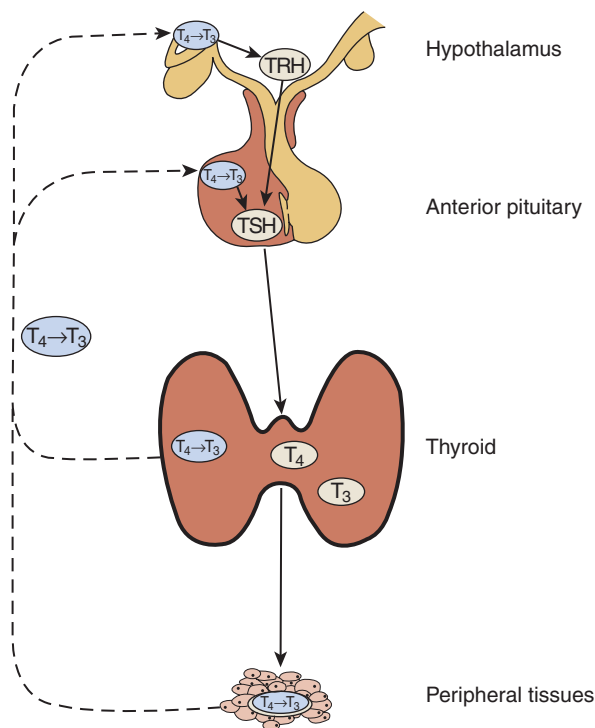

FIG 16.6 The hypothalamic–pituitary–thyroid axis. Solid lines correspond to stimulatory effects, and dotted lines depict inhibitory effects. Conversion of thyroxine (T_4) to triiodothyronine (T_3) in the pituitary and the hypothalamus is mediated by 5′-deiodinase type II. This event also is important throughout the central nervous system, thyroid, and muscle. 5′-Deiodinase type I (propylthiouracil sensitive) plays a major role in liver, kidney, and thyroid function. TRH, Thyrotropin-releasing hormone; TSH, thyroid-stimulating hormone. (Redrawn from DeGroot LJ, Jameson JL: *Endocrinology*, ed 5, vol 2, Philadelphia, 2006, Saunders.)

blood, T_4 and T_3 are almost entirely bound to plasma proteins.^{5,16,17,23,33}

Binding plasma proteins consist of thyroxine-binding globulin (TBG), transthyretin, and thyroid-binding albumin (TBA). Small amounts of T_3 and T_4 are bound to high-density lipoproteins.¹¹ The most important thyroid hormone-binding serum protein is TBG, which binds about 70% of T_4 and 75% to 80% of T_3 .¹¹ Only 0.02% to 0.03% of free thyroxine (FT_4) and about 0.3% of free triiodothyronine (FT_3) is found in plasma.^{9,11,16}

Pathophysiology

Hypothyroidism is associated with low T_4 and T_3 plasma levels, which often are found in ill and medicated older persons because illness and aging can reduce the conversion of T_4 to T_3 .³⁴

Protein abnormalities can also affect T_4 and T_3 levels.

Antibodies to various thyroid structures within the thyroid are associated with autoimmune diseases (i.e., Graves disease and Hashimoto thyroiditis) of the thyroid. Three autoantibodies are most often involved in autoimmune thyroid disease: TSH receptor antibodies (TSHRAb), thyroid peroxidase antibodies (TPoAb), and thyroglobulin antibodies (TgAb).³⁵ TSHRAb are not found in the general population but are present in 80% to 95% of patients with Graves disease and in 10% to 20% of those with autoimmune thyroiditis. Most TSHRAb in Graves disease are stimulating antibodies, which stimulate the release of thyroid hormone. However, blocking antibodies to the TSH receptor (TSHR-blocking Ab) also are found, which block the release of thyroid hormone. The ratio of these TSH receptor antibodies determines the clinical status of the patient and the functional status of the thyroid gland.^{5,26,35}

TgAb are found in about 10% to 20% of the general population, 50% to 70% of patients with Graves disease, and 80% to 90% of those with autoimmune thyroiditis.^{7,12,19} TPoAb are found in 8% to 27% of the general population. TPoAb are found in about 50% to 80% of patients with Graves disease and in more than 90% of patients with autoimmune thyroiditis.^{5,16,26,35}

Laboratory and Diagnostic Findings

Several tests are available that measure thyroid function. Highly specific and sensitive radioimmunoassays are used most often to measure serum T_4 and T_3 concentrations and rarely to measure reverse T_3 (rT_3) concentration. Normal ranges for T_4 and T_3 are provided in Table 16.2.³⁶ Elevated levels usually indicate hyperthyroidism, and lower levels usually indicate hypothyroidism. Free hormone levels usually correlate better with the metabolic state than do total hormone levels.^{5,17,36}

Immunoradiometric or chemiluminescent measurement of basal serum TSH concentration is useful in the diagnosis of hyperthyroidism and hypothyroidism (for the normal range for TSH, see Table 16.2). In cases of hyperthyroidism,

TABLE 16.2 Laboratory Tests

Test	Normal Range	Interpretation
Radioactive iodine uptake (RIU)	5%–30%	Elevated: hyperthyroidism Decreased: hypothyroidism
Thyroid-stimulating hormone (TSH)	0.5–4.5 mIU/L	Elevated: hypothyroidism Suppressed: hyperthyroidism
Total serum T_4 (TT_4)	5–12 μ g/dL 64–154 nmol/L	High: hyperthyroidism Low: hypothyroidism
Free T_4 (FT_4)	1.0–3.0 ng/dL 13–39 pmol/L	Increased: hyperthyroidism Decreased: hypothyroidism
Total serum T_3 (TT_3)	1.2–2.9 nmol/L 80–190 ng/dL	High: hyperthyroidism Low: hypothyroidism
Free T_3 (FT_3)	0.25–0.65 ng/dL 3.8–10 nmol/L	Increased: hyperthyroidism Decreased: hypothyroidism

the TSH level is almost always low or nondetectable. Higher levels indicate hypothyroidism.^{5,17,36,37}

Direct tests of thyroid function also involve the administration of radioactive iodine (RAI). Measurement of thyroid radioactive iodine uptake (RAIU) is the most common of these tests. 131 I has been used for this test, but 123 I is preferred because it exposes the patient to a lower radiation dose. RAIU, which is measured 24 hours after administration of the isotope, varies inversely with plasma iodide concentration and directly with the functional status of the thyroid. In the United States, normal 24-hour RAIU is 15% to 30%. RAIU discriminates poorly between normal and hypothyroid states. Values above the normal range usually indicate thyroid hyperfunction.^{36,37}

Other tests used in selected cases include the TSH stimulation test; the T_3 suppression test; and radioassay techniques for measuring TSHRAb, TSHR-blocking Ab, TPoAb, and TgAb.^{17,36} A thyroid scan commonly is used to localize thyroid nodules and to locate functional ectopic thyroid tissue. 123 I or 99 Tc (technetium) is injected, and a scanner localizes areas of radioactive concentration. This technique allows for the identification of nodules 1 cm or larger. When a pinhole thyroid scan is used, 2- to 3-mm lesions may be detected.^{16,36,38,39}

Ultrasonography may be used to detect thyroid lesions. Nodules 1 to 2 mm in size can be identified. This technique also is used to distinguish solid from cystic lesions, measure the gland, and guide needles for aspiration of cysts or for biopsy of thyroid masses. Computed tomography (CT) and magnetic resonance imaging (MRI) are helpful mainly in the postoperative management of patients with thyroid cancer. These forms of imaging also are used for the preoperative evaluation of larger lesions of the thyroid (>3 cm in diameter) that extend beyond the gland into adjacent tissues.^{16,36,38,39}

THYROTOXICOSIS (HYPERTHYROIDISM)

The term *thyrotoxicosis* refers to an excess of T_4 and T_3 in the bloodstream. This excess may be the result of production by ectopic thyroid tissue, multinodular goiter, or thyroid adenoma or may be associated with subacute thyroiditis (painful and painless), pituitary disease involving the anterior portion of the gland, or ingestion of thyroid hormone (thyrotoxicosis factitia) or foodstuffs containing thyroid hormone. When thyrotoxicosis occurs, it is most commonly associated with Graves disease, toxic nodular goiter, or acute thyroiditis.^{11,17,24,26}

Graves disease is an autoimmune disease in which thyroid-stimulating immunoglobulins bind to and activate thyrotrophic receptors, causing the gland to grow and stimulating the thyroid follicles to increase T_4 and T_3 synthesis.^{11,17,26} The chief risk factors for Graves disease are genetic mutations (i.e., in susceptibility genes for CD40, cytotoxic T lymphocyte antigen [CTLA-4], thyroglobulin, TSH receptor, and PTPN22²⁶) and female gender, in part because of modulation of the autoimmune response by estrogen. This disorder is much more common in women (with a male-to-female ratio of 10:1) and may manifest during puberty or pregnancy or at menopause (see Fig. 16.3).⁵ Genetic predisposition along with emotional stress such as severe fright or separation from loved ones has been reported to be associated with its onset. The disease may occur in a cyclic pattern and may then “burn itself out” or continue in an active state.^{11,17,26} Epstein-Barr virus infection may play a role in autoantibody production in cases of Graves and Hashimoto diseases.⁴⁰

Clinical Presentation

Signs and Symptoms. Direct and indirect effects of excessive thyroid hormones contribute to the clinical picture in Graves disease. The most common symptoms and signs are nervousness, fatigue, rapid heartbeat or palpitations, heat intolerance, and weight loss (see Table 16.3). These manifestations are reported in more than 50% of all diagnosed patients. With increasing age, weight loss and decreased appetite become more common, and irritability and heat intolerance are less common. Atrial fibrillation is rare in patients younger than 50 years of age but occurs in approximately 20% of older patients. The patient’s skin is warm and moist and the complexion rosy; the patient may blush readily. Palmar erythema may be present, profuse sweating is common, and excessive melanin pigmentation of the skin is evident in many patients; however, pigmentation of the oral mucosa has not been reported. In addition, the patient’s hair becomes fine and friable, and the nails soften.^{5,11,17,26}

Graves ophthalmopathy, which is identified in approximately 50% of patients, is characterized by edema and inflammation of the extraocular muscles, as well as an increase in orbital connective tissue and fat. Ophthalmopathy is an organ-specific autoimmune process that is strongly linked to Graves hyperthyroidism. Although

hyperthyroidism may be successfully treated, ophthalmopathy often produces the greatest long-term disability for patients with this disease. Figs. 16.7 and 16.8 demonstrate the changes associated with ophthalmopathy (eyelid retraction, proptosis, periorbital edema, chemosis,

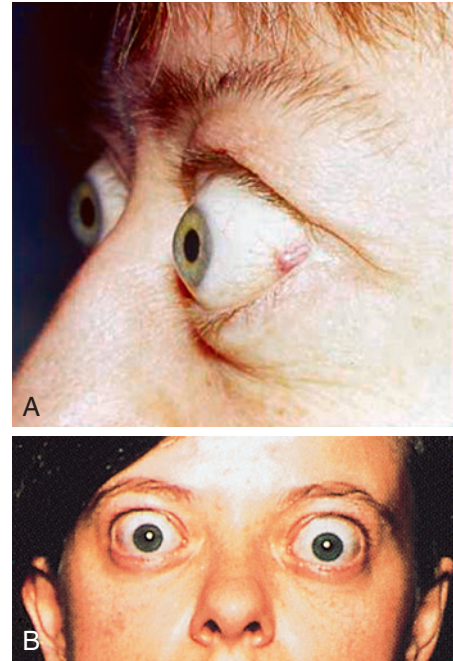

FIG 16.7 Eyelid changes in Graves disease. **A**, Eyelid retraction is a common eye sign in Graves disease. It is recognized when the sclera is visible between the lower margin of the upper eyelid and the cornea. **B**, Proptosis in Graves disease results from enlargement of muscles and fat within the orbit as a result of mucopolysaccharide infiltration. (A, From Goldman L, Ausiello D: *Cecil textbook of medicine*, ed 23, Philadelphia, 2008, Saunders. B, From Seidel H: *Mosby’s guide to physical examination*, 4th ed 4, St. Louis, 1999, Mosby.)

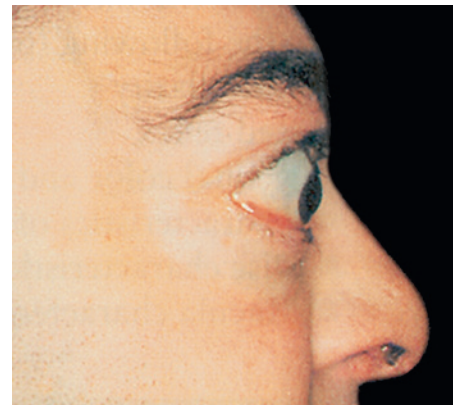

FIG 16.8 Exophthalmos of Graves disease can be unilateral or bilateral. The forward protrusion of the globe results from an increase in volume of the orbital contents. (From Stein HA, Stein RM, Freeman MI: *The ophthalmic assistant: a text for allied and associated ophthalmic personnel*, ed 8, Philadelphia, 2006, Mosby.)

TABLE 16.3 Clinical Findings and Treatment of Thyroid Disorders

Condition	Signs and Symptoms	Laboratory Tests	Treatment
Hyperthyroidism	<p><i>Skeletal</i>—osteoporosis</p> <p><i>Cardiovascular</i>—palpitations, tachycardia, arrhythmias, hypertension, cardiomegaly, congestive heart failure, angina, MI</p> <p><i>GI</i>—weight loss, increased appetite, pernicious anemia</p> <p><i>CNS</i>—anxiety, restlessness, sleep disturbances, emotional lability, impaired concentration, weakness, tremors (hands, fingers, tongue)</p> <p><i>Skin</i>—erythema, thin fine hair, areas of alopecia, soft nails</p> <p><i>Eyes</i>—retraction of upper eyelid, exophthalmos, corneal ulceration, ocular muscle weakness</p> <p><i>Other</i>—increased risk for diabetes, decreased serum cholesterol level, increased risk for thrombocytopenia, sweating</p>	<p>T₄—elevated</p> <p>T₃—elevated</p> <p>TSH—none or very decreased</p> <p>TBG—elevated</p> <p>Normal range:</p> <p>T₄—5–12 µg/dL or 64–154 nmol/L</p> <p>T₃—80–190 ng/dL or 1.2–2.9 nmol/L</p> <p>TSH—0.5–4.5 mIU/L</p> <p>TBG—1–25 ng/mL</p>	<p>Antithyroid agents: propylthiouracil, carbimazole, methimazole</p> <p>RAI</p> <p>Subtotal thyroidectomy</p> <p>Propranolol: for adrenergic component in thyrotoxicosis (sweating, tremor, and tachycardia)</p>
Hypothyroidism	<p><i>Musculoskeletal</i>—arthritis, muscle cramps</p> <p><i>Cardiovascular</i>—shortness of breath, hypotension, slow pulse</p> <p><i>GI</i>—constipation, anorexia, nausea or vomiting</p> <p><i>CNS</i>—mental and physical slowness, sleepiness, headache</p> <p><i>General</i>—dry, thick skin and dry hair; fatigue; edema (puffy hand, face, eyes), cold intolerance; hoarseness; weight gain</p>	<p>T₄—decreased</p> <p>T₃—decreased</p> <p>TSH—elevated</p> <p>TBG—decreased</p>	<p>Sodium levothyroxine (Synthroid, LT₄) or sodium liothyronine (Leotrix, LT₃)</p>
Thyroiditis	<p><i>Hashimoto</i>—rubbery firm goiter, hypothyroidism develops later</p> <p><i>Subacute painful</i>—enlarged, firm, tender gland, pain that may radiate to ear or jaw</p> <p><i>Acute suppurative</i>—pain, tenderness in gland, fever, malaise</p> <p><i>Chronic fibrosing</i>—hard, fixed, enlarged gland</p> <p><i>Subacute painless</i>—firm, nontender, enlarged gland</p>	<p>Later in disease: T₄, T₃, and TBG are decreased; TSH becomes elevated</p> <p>Hyperthyroid returning to euthyroid status</p> <p>Euthyroid</p> <p>Usually remains euthyroid; hypothyroid status can occur</p> <p>Hyperthyroid for 5–6 months, returning to euthyroid status</p>	<p>Thyroid hormone; surgery in rare cases (compression of vital tissues)</p> <p>Aspirin, prednisone, propranolol for symptoms of thyrotoxicosis</p> <p>Incision and drainage, appropriate antibiotics</p> <p>Usually none; surgery if vital tissues compressed, thyroid hormone</p> <p>Propranolol for symptoms of thyrotoxicosis</p>

CNS, Central nervous system; GI, gastrointestinal; RAI, radioactive iodine; T₃, triiodothyronine; T₄, tetraiodothyronine (thyroxine); TBG, thyroid-binding globulin; TSH, thyroid-stimulating hormone.

Data from references^{11,17,26,28,46}.

and bilateral exophthalmos). This disease may progress to visual loss through exposure keratopathy or compressive optic neuropathy.^{41,42}

In addition, most thyrotoxic patients show eye signs not related to Graves ophthalmopathy. These signs (i.e., stare with widened palpebral fissures, infrequent blinking, eyelid lag, jerky movements of the lids, and failure to wrinkle the brow on upward gaze) result from sympathetic overstimulation and usually clear when thyrotoxicosis is corrected.^{41,42}

Another complication, which is found in about 1% to 2% of patients with Graves disease, is dermopathy (Fig. 16.9).⁵ This condition involving focal areas of the skin is the result of lymphocytic infiltration, lymphokine activation of fibroblasts, and hyaluronic acid and chondroitin sulfate deposition in the dermis. Nodular and plaque formation and nonpitting edema may occur in chronic lesions. These lesions are most common over the anterolateral aspects of the shin. Patients with dermopathy almost always develop severe ophthalmopathy.^{5,11,26,41,42}



FIG 16.9 Infiltrative dermopathy seen in Graves disease. Hyperpigmented, nonpitting induration of the skin of the legs usually is found in the pretibial area (pretibial myxedema). Lesions are firm, and clear edges can be seen. (From Melmed S, Polonsky K, Larsen P, et al: *Williams textbook of endocrinology*, ed 12, Philadelphia, 2011, Saunders. Courtesy of Dr. Andrew Werner, New York, NY.)

Thyroid acropachy is another rare manifestation of Graves disease. This feature is associated with presence of TgAbs (Fig. 16.10). It is characterized by clubbing and soft tissue swelling of the last phalanx of the fingers and toes. The overlying skin often is discolored and thickened. Subperiosteal new bone formation occurs, along with glycosaminoglycan deposits in the skin.^{5,26}

Increased metabolic activity caused by excessive hormone secretion increases circulatory demand; increases in stroke volume and heart rate often are noted, in addition to widened pulse pressure, resulting in palpitations. Supraventricular cardiac dysrhythmias develop in many patients. CHF may occur and often is somewhat resistant to the effects of digitalis. Patients with untreated or incompletely treated thyrotoxicosis are highly sensitive to the actions of epinephrine or other pressor amines, so the use of these agents is contraindicated in this setting. After good medical management has been instituted, however, administration of these agents can be resumed.^{11,26,41}

Dyspnea not related to the effects of CHF may occur in some patients. The respiratory effect is caused by reduction in vital capacity related to weakness of the respiratory muscles. Weight loss, despite an increased appetite, is a common finding in younger patients. Stools



FIG 16.10 Thyroid acropachy. Thyroid acropachy is an extreme manifestation of autoimmune thyroid disease. It presents with digital clubbing, swelling of digits and toes, and periosteal reaction of extremity bones. (From James WD, Berger T, Elston DMD: *Andrews' diseases of the skin*, ed 11, London, 2011, Saunders.)

are poorly formed, and the frequency of bowel movements is increased. Anorexia, nausea, and vomiting are rare but when they occur may herald the onset of thyroid storm. Gastric ulcers are rare, although many of these patients have achlorhydria, and about 3% develop pernicious anemia.^{11,26,28}

Thyrotoxic patients tend to be nervous and often show a great deal of emotional lability, losing their tempers easily and crying often; severe psychiatric reactions may occur. Patients cannot sit still and are always moving. A tremor of the hands and tongue, along with lightly closed eyelids, often is present; in addition, generalized muscle weakness may lead to easy fatigability (see Table 16.2).^{11,26,28}

Thyrotoxic patients have increased excretion of calcium and phosphorus into their urine and stools, and radiographs show increased bone loss. Hypercalcemia occurs sometimes, but serum levels of alkaline phosphatase usually are normal. Bone age in young patients is advanced (see Chapter 12).^{11,26,28} Glucose intolerance and, rarely, diabetes mellitus may accompany hyperthyroidism. Patients with diabetes who are treated with insulin require an increased dose of insulin if they develop Graves disease.⁴¹ Individual red blood cells (RBCs) in patients with thyrotoxicosis usually are normal; however, the RBC mass is enlarged, to carry the additional oxygen needed for increased metabolic activities. In addition to the increased total numbers of circulating RBCs, the bone marrow reveals erythroid hyperplasia, and requirements for vitamin B₁₂ and folic acid are increased. White blood cell (WBC) count may be decreased because of a reduction in the number of neutrophils, but the absolute number of eosinophils may be increased. Enlargement of the spleen and lymph nodes occurs in some patients; thrombocytopenia has been reported.^{11,26,41} Increased metabolic activity associated with thyrotoxicosis leads to increased secretion and breakdown

of cortisol; however, serum levels remain within normal limits.

Laboratory Findings

T₄, T₃, TBG, and TSH tests are used to screen for hyperthyroidism. A low TSH level and a high free T₄ concentration are classically combined in hyperthyroidism (see Table 16.2). Some hyperthyroid patients have a low TSH level and a normal free T₄ concentration, but they have an elevated free T₃ level. A few patients have normal or elevated TSH and high free T₄. These patients usually are found to have a TSH-secreting pituitary adenoma or thyroid hormone resistance syndrome.^{5,9,11,26,41}

Medical Management

Treatment of patients with thyrotoxicosis may involve antithyroid agents that block hormone synthesis, iodides, RAI, or subtotal thyroidectomy (Box 16.1).⁵ The antithyroid agents most often used in the United States are propylthiouracil and methimazole, both of which inhibit thyroid peroxidase and thus the synthesis of thyroid hormone. Propylthiouracil also blocks extrathyroidal

deiodination of T₄ to T₃. Carbimazole is the drug of choice in the United Kingdom, and propylthiouracil is the drug of choice in North America. The usual duration of treatment ranges up to 18 months. Antithyroid agents may cause a mild leukopenia, but drug therapy is not stopped unless the WBC count is more severely depressed. In rare cases, agranulocytosis may occur (Box 16.2). If sore throat, fever, or mouth ulcers develop, most physicians advise the patient to stop the antithyroid medication and have a WBC count performed.^{11,26,41}

Administration of RAI is the preferred initial treatment for patients with Graves disease in North America. RAI is contraindicated in pregnant women and women who are breastfeeding. RAI can induce or worsen ophthalmopathy, particularly in smokers. The main adverse effect associated with RAI is hypothyroidism. The incidence of cancer is unchanged or slightly reduced in patients treated with RAI, but the risk of death from thyroid cancer and possibly other cancers is slightly increased. Patients with severe hyperthyroidism should be treated with an antithyroid drug for 4 to 8 weeks before RAI therapy is initiated. This approach reduces the slight risk of thyrotoxic crisis if RAI was given initially.^{11,26,41}

Subtotal thyroidectomy is preferred by some patients with a large goiter and is indicated in those with a coexistent thyroid nodule whose nature is unclear. The

BOX 16.1 Treatment of Thyrotoxicosis

Severe Thyrotoxicosis

Propylthiouracil (PTU) 100 to 150 mg every 8 hours; in some cases, PTU 200 to 300 mg every 6 hours. With decrease in symptoms, the PTU dosage can be lowered. As improvement continues, can switch to once-a-day methimazole (MMI) 2.5 to 5.0 mg once per day for 12 to 24 months.

Moderate Thyrotoxicosis

Start with MMI, which is 10 times more potent than PTU. MMI also has longer intrathyroid residence time but does not inhibit conversion of thyroxine (T₄) to triiodothyronine (T₃) as PTU does. Start with 30 to 40 mg/day once per day. Within 4 to 6 weeks, the patient will be euthyroid. Reduce dosage to 5 to 15 mg/day for 12 to 24 months. Relapses are frequent, and drug side effects may complicate treatment.⁷²

¹³¹I Therapy

¹³¹I therapy is the most common form of treatment in the United States. Antithyroid drugs are given first to make the patient euthyroid. The antithyroid medicine is stopped for 3 to 5 days; then 6000 to 8000 rad dosage of ¹³¹I is given. More than 80% of the patients are cured with a single dose of ¹³¹I. Delayed control of thyrotoxicosis and lower efficacy are typical with large goiters.⁷²

Surgery

The patient must be euthyroid before surgery is performed, usually achieved with one of the antithyroid drugs (PTU or MMI). Subtotal thyroidectomy is the treatment of choice. Hypoparathyroidism occurs in 0.9% to 2.0% of cases, and recurrent laryngeal nerve damage is found in 0.1% to 2.0% of cases. Bleeding, infection, and anesthetic complications can occur. Surgery results in a fast correction of thyrotoxicosis but at a high cost.⁷²

BOX 16.2 Side Effects of Antithyroid Drugs

Severe

Agranulocytosis (0.2%–0.5%)

Only rare cases reported
Hepatitis (can result in hepatic failure)
Cholestatic jaundice
Thrombocytopenia

Hypoprothrombinemia

Aplastic anemia
Lupus-like syndrome with vasculitis
Hypoglycemia (insulin antibodies)

Less Severe

Most Frequent (1%–5%)

Rash
Urticaria
Arthralgia
Decreased leukocyte level (drop in white blood cell counts by 2–3 × 10³)
Fever

Less Frequent

Arthritis
Diarrhea
Decreased sense of taste

*Propylthiouracil and methimazole.

Data from Goldman L, Ausiello D, editors: *Cecil textbook of medicine*, eds 23 and 24, Philadelphia, 2008 and 2016, Saunders.

patient is first treated with an antithyroid drug for about 7 days before surgery. In major centers, hyperthyroidism is cured in more than 98% of cases, and low rates of operative complications are reported. Postoperative hypothyroidism becomes more frequent as the accumulated effects of multiple surgical treatments result in near-total thyroidectomy.^{9,41}

If exophthalmos is present, it follows a course independent of the therapeutic metabolic response to antithyroid treatment modalities and usually is irreversible. The adrenergic component in thyrotoxicosis can be managed with β -adrenergic antagonists such as propranolol. Propranolol alleviates adrenergic manifestations such as sweating, tremor, and tachycardia.^{11,26,41}

Management of Thyrotoxic Crisis. Patients with thyrotoxicosis who are untreated or incompletely treated may develop thyrotoxic crisis, a serious but fortunately rare complication of abrupt onset that may occur at any age. Thyrotoxic crisis occurs in fewer than 1% of patients hospitalized for thyrotoxicosis.^{11,26,41} Most patients who develop thyrotoxic crisis have a goiter, wide pulse pressure, eye signs, and a long history of thyrotoxicosis. Precipitating factors include infection, trauma, surgical emergencies, and operations. Early signs and symptoms of extreme restlessness, nausea, vomiting, and abdominal pain have been reported; fever, profuse sweating, marked tachycardia, cardiac arrhythmias, pulmonary edema, and CHF soon develop. The patient appears to be in a stupor, and coma may follow. Severe hypotension develops, and death may occur.

Pregnant women with inadequate control of maternal thyrotoxicosis are at increased risk of spontaneous abortion, CHF, thyrotoxic storm, preeclampsia, preterm delivery, low birth weight, and stillbirth. Despite the lack of consensus among professional organizations, recent studies support universal screening in all pregnant women in the first trimester for thyroid diseases.^{43,44}

These reactions appear to be associated, at least in part, with adrenal cortical insufficiency.^{11,26,41} Immediate treatment for the patient in thyrotoxic crisis consists of large doses of antithyroid drugs (200 mg of propylthiouracil), potassium iodide, propranolol (to antagonize the adrenergic component), hydrocortisone (100–300 mg), dexamethasone (2 mg orally every 6 hours to inhibit release of hormone from the gland and peripheral conversion of T_4 to T_3), intravenous (IV) glucose solution, vitamin B complex, wet packs, fans, and ice packs. Cardiopulmonary resuscitation is sometimes needed.^{11,26,41}

Thyrotoxicosis factitia is a condition resulting from chronic ingestion of excessive quantities of thyroid hormone. It usually occurs in patients with underlying psychiatric disease or in persons who have access to the medication or use it as a weight loss agent.^{11,16,26}

Other Causes of Thyrotoxicosis

Thyrotoxicosis has been reported to occur in patients who ate ground beef containing large quantities of bovine

thyroid. Functional ectopic thyroid tissue also can cause thyrotoxicosis. Thyroid tissue may be found in ovarian teratomas (struma ovarii). In rare cases, hyperfunctioning metastases of follicular carcinoma may cause thyrotoxicosis.^{11,16,26}

THYROIDITIS

Thyroiditis is inflammation of the thyroid gland, which may occur for a variety of reasons. Five types of thyroiditis have been identified: Hashimoto, subacute painful, subacute painless, acute suppurative, and Riedel (Table 16.4).^{11,16,45-47} Radiation therapy and drugs such as lithium, interleukin-2, interferons, and amiodarone also may cause thyroiditis iatrogenically.^{11,16,45-47} In some cases (subacute painful thyroiditis), inflammation may result from transient hyperthyroidism caused by follicle damage and release of preformed thyroid hormone.⁴⁵ By contrast, Hashimoto thyroiditis (chronic autoimmune thyroiditis) results in progressive hypothyroidism.^{11,16,45-47}

Because Hashimoto thyroiditis is the most common type of thyroiditis, it is discussed next in greater detail.

CLINICAL PRESENTATION— HASHIMOTO THYROIDITIS

Hashimoto thyroiditis is the most common cause of primary hypothyroidism in the United States.^{4,45} It is an autoimmune disorder that manifests most often as an asymptomatic diffuse goiter. High titers of circulating thyroid autoantibodies and thyroid antigen-specific T cells are observed. It usually affects young and middle-aged women and is three to four times more frequent in women than men.^{4,45} By the time the diagnosis has been established, most patients are hypothyroid. A family history of Hashimoto thyroiditis or other autoimmune thyroid disorder often is reported.^{11,16,45-47} It may be associated with other autoimmune diseases such as pernicious anemia and type 1 diabetes mellitus.^{11,16,45-47}

Signs and Symptoms

Goiter is the clinical hallmark of Hashimoto thyroiditis (Fig. 16.11). The goiter usually is moderate in size and rubbery firm in consistency, and it moves freely with swallowing. In cases of sudden onset, the clinical picture suggests subacute thyroiditis with pain. Patients may be euthyroid (normal function) during early phases of the disease. Early in the disease course, the thyroid becomes enlarged and firm and may have a nodular consistency. Over time, most patients develop hypothyroidism as lymphocytes replace functioning tissue. In a few cases, the patient develops transient hyperthyroidism, to be followed later by hypothyroidism.^{4,11,16,35,47}

Laboratory Findings

Early in the course of Hashimoto disease, the patient is euthyroid, but TSH level is often slightly increased and

TABLE 16.4 Thyroiditis

Type	Cause	Clinical Findings	Thyroid Function	Treatment
Hashimoto thyroiditis	Autoimmune related	Goiter—moderate in size, rubbery, firm	Euthyroid early Few cases with transient hyperfunction Hypothyroidism develops in most cases	Thyroid hormone In rare cases of compression of vital tissues, surgery is indicated
Subacute painful thyroiditis	Possible viral infection	Enlarged, firm, tender, gland with pain that may radiate to ear, jaw, or occipital region	Hyperthyroidism with return to euthyroid state	Aspirin Prednisone Propranolol for symptoms of thyrotoxicosis
Acute suppurative thyroiditis	Bacterial infection	Pain and tenderness in gland; fever, malaise; skin over the gland warm and red	Euthyroid	Incision and drainage, appropriate antibiotics
Chronic fibrosing thyroiditis (Riedel)	Unknown	Enlarged gland that is stony hard and fixed to surrounding tissues	Usually remain euthyroid but in some cases hypothyroidism may occur	Usually none; if vital structures are compressed, surgery is indicated; thyroid hormone
Subacute painless thyroiditis (postpartum thyroiditis)	Not established but related to autoimmune thyroid disease	Enlarged gland that is firm and nontender; may occur in women 5–6 months after pregnancy	Hyperthyroidism for 5–6 months; then return to euthyroid state	Propranolol for symptoms of thyrotoxicosis

Data from references^{11,16,46}



FIG 16.11 Hashimoto disease is the most common cause of goitrous hypothyroidism. The initial lesion consists of a diffuse goiter, and the patient may be euthyroid. Later the patient becomes hypothyroid, and very late in the disease, the gland atrophies. (From Forbes CD, Jackson WF: *Color atlas and text of clinical medicine*, ed 3, Edinburgh, 2003, Mosby.)

the RAIU is increased. Increasing titers of autoantibodies are found early in the disease; anti-TPOAb and anti-TgAb are the most important from a clinical standpoint. Fine-needle biopsy of the thyroid gland at this stage helps to confirm the diagnosis. Later in the disease, serum levels of T_4 and T_3 start to fall, and the level of TSH continues

to increase. At this stage, the patient is hypothyroid and requires treatment with hormone replacement.^{11,16,35,37,47}

MEDICAL MANAGEMENT

Early in the course of the disease, patients with Hashimoto disease have small goiters, are asymptomatic, and do not require treatment. Patients with larger goiters or mild hypothyroidism are treated with thyroid hormone replacement. More recent goiters usually respond by decreasing in size. Long-standing goiters often do not respond to hormone treatment. In these cases, unsightly goiters or those compressing adjacent structures may be managed surgically after an attempt has been made to decrease their size with the use of hormone therapy. Patients with full-blown hypothyroidism require hormone replacement treatment.^{11,16,28,35,47}

HYPOTHYROIDISM

The causes of hypothyroidism can be divided into four main categories (see Table 16.1): primary atrophic, secondary, transient, and generalized resistance to thyroid hormone. Up to 95% of cases of hypothyroidism are caused by primary and goitrous hypothyroidism. Hypothyroidism may be congenital or acquired. The acquired form may result from failure of the thyroid gland or pituitary gland and commonly is caused by irradiation of the thyroid gland (RAI), surgical removal, or excessive antithyroid drug therapy.^{11,16,17,28}

Subclinical hypothyroidism is a prevalent condition that is characterized by elevated serum TSH concentration

and normal serum FT₄ and T₃.²⁸ Subclinical hypothyroidism secondary to chronic autoimmune thyroiditis has a predictable clinical course.¹³ Spontaneous return to normal TSH values occurs in 5% to 6% of cases. Progression to overt hypothyroidism occurs at a rate of about 5% per year. Some patients report fatigue, weight gain, poor memory, poor ability to concentrate, and depressed feelings.^{28,37} In well-functioning community-dwelling older adults, subclinical thyroid dysfunction does not appear to contribute to decreased functional capacity.⁴⁸

EPIDEMIOLOGY

Permanent hypothyroidism occurs about once in every 4000 live births in the United States. Transient hypothyroidism occurs in 1% to 2% of newborns. Most infants with permanent congenital hypothyroidism have thyroid dysgenesis. Acquired hypothyroidism affects about 2% of adult women and about 0.1% to 0.2% of adult men in North America.^{11,16,17,28,33} It is most common in older adults and may be caused by chronic autoimmune thyroiditis, postpartum thyroiditis, ¹³¹I therapy, thyroidectomy, or antithyroid drugs.

CLINICAL PRESENTATION

Signs and Symptoms

Neonatal hypothyroidism is characterized by dwarfism; overweight; well-recognized facial features consisting of a broad flat nose, wide-set eyes, thick lips, and a large protruding tongue; poor muscle tone; pale skin; stubby hands; retarded bone age; delayed eruption of teeth; malocclusions; a hoarse cry; an umbilical hernia; and mental retardation (Fig. 16.12). All of these abnormalities can be prevented by early detection and treatment.

The onset of hypothyroidism in older children and adults (Fig. 16.13) is manifested by characteristic changes



FIG 16.12 Congenital hypothyroidism.

in physical appearance: a dull expression; puffy eyelids; alopecia of the outer third of the eyebrows; palmar yellowing; dry and rough skin; and dry, brittle, and coarse hair, along with increased size of the tongue. Other features include slowing of physical and mental activity, slurred and hoarse speech, anemia, constipation, increased sensitivity to cold, increased capillary fragility, weight gain, muscle weakness, and deafness (see Table 16.2).^{1,8}

Accumulation of subcutaneous fluid (intracellularly and extracellularly) usually is not as pronounced in patients with pituitary myxedema as it is in those with primary (thyroid) myxedema. Serum cholesterol levels are elevated in thyroid myxedema and are closer to normal values in patients with pituitary myxedema. Untreated patients with severe myxedema may develop hypothyroid coma, which usually is fatal. T₄, T₃, TBG, and TSH tests are used to screen for hypothyroidism.^{11,16,17,28} Features indicative of hypothyroidism are shown in Table 16.2.

MEDICAL MANAGEMENT

Patients with hypothyroidism are treated with synthetic preparations that contain sodium levothyroxine (LT₄) or sodium liothyronine (LT₃).^{11,16,17,28} The usual prescribed dose of sodium levothyroxine for patients of ideal body weight is 75 to 100 µg/day. In hypothyroid patients receiving warfarin or other related oral anticoagulants, treatment with T₄ may cause further prolongation of prothrombin time, associated with risk for hemorrhage. In addition, hypothyroid patients with diabetes with a



FIG 16.13 Clinical hypothyroidism. Characteristic nonpitting edematous changes are evident in the skin of the face. Note the dry skin, puffy facial appearance, and coarse hair. (Courtesy of Paul W. Ladenson, MD, The Johns Hopkins University and Hospital, Baltimore, MD. In Seidel HM, et al: *Mosby's guide to physical examination*, ed 7, St. Louis, 2011, Mosby.)

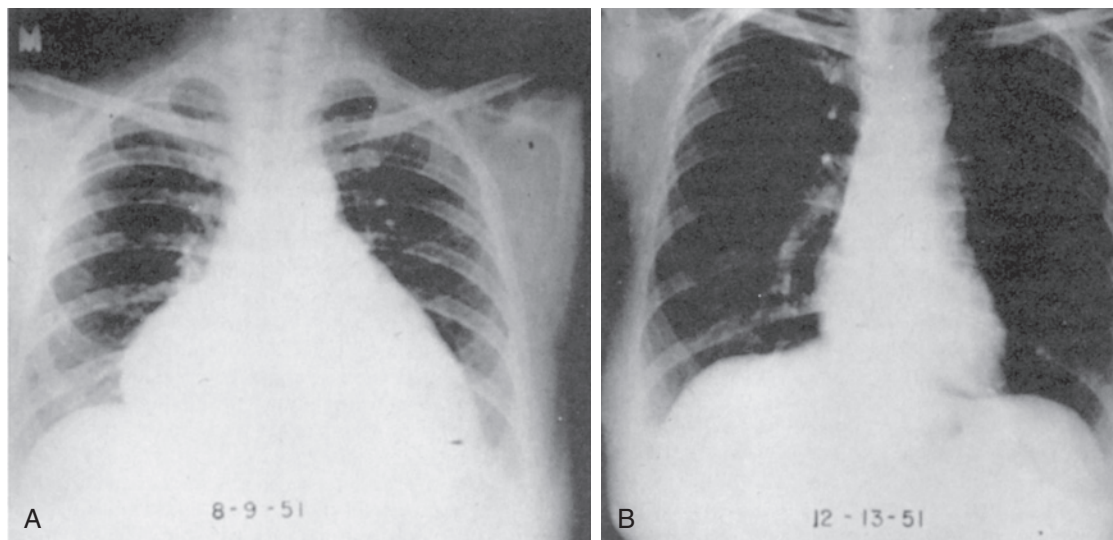

FIG 16.14 **A**, Radiograph showing enlargement of the heart in a patient with heart failure caused by myxedema. **B**, After treatment with thyroid hormone, the radiograph shows a return to normal heart size. (From Melmed S, et al: *Williams textbook of endocrinology*, ed 12, Philadelphia, 2011, Saunders.)

decreased need for insulin or sulfonylureas may become hyperglycemic when treated with T_4 .^{11,16,17,28}

Congestive heart failure may occur in severe cases of myxedema. Levothyroxine therapy can correct this condition (Fig. 16.14). The treatment of hypothyroid children with levothyroxine can result in a dramatic reversal of the associated clinical changes (Fig. 16.15).

Patients with untreated hypothyroidism are sensitive to the actions of narcotics, barbiturates, and tranquilizers, so these drugs must be used with caution. Smoking can worsen the disease. Stressful situations such as cold, operations, infections, or trauma may precipitate a hypothyroid (myxedema) coma in untreated hypothyroid patients. This condition is noted for severe myxedema, bradycardia, and severe hypotension.^{1,8}

Myxedematous coma occurs most often in severely hypothyroid elderly persons. It is more common during the winter months and carries a high mortality rate. Hypothyroid coma is treated by parenteral levothyroxine (T_4) and steroids; the patient is covered to conserve heat. Hypertonic saline and glucose may be required to alleviate dilutional hyponatremia and occasional hypoglycemia, respectively.^{11,16,17,28}

THYROID CANCER

Three main histologic types of thyroid cancer have been identified: differentiated, medullary, and anaplastic. Differentiated cancers are subdivided into papillary, follicular, mixed, and Hürthle cell carcinomas^{3,11,16,20,21,31} (see Table 16.5). In addition, primary lymphomas may occur in the thyroid gland, and other cancers may metastasize to the thyroid. An important neoplastic syndrome, multiple endocrine neoplasia type 2 (MEN2), involves the thyroid

TABLE 16.5 Classification of Thyroid Cancer

Type (Histologic)	Frequency (%)	10-Year Survival Rate (%)
Differentiated—papillary	75–80	>90
Differentiated—follicular	8–10	80
Differentiated—Hürthle cell	1	70
Anaplastic	1–5	<2
Medullary	5–8	40
Lymphoma	1–5	45
Metastases to the thyroid	<1	Determined by primary

Data from references^{11,16,20,52,55}.

gland. MEN2 consists of medullary thyroid carcinoma (MTC), pheochromocytoma in 50% of cases, and parathyroid hyperplasia or adenoma in 10% to 35% of cases.⁴⁹ In rare cases, cancer from other locations may metastasize to the thyroid gland.⁵⁰ The kidney is the most common site of origin for metastasis to the thyroid gland; other sites include cancer of the breast and lung and melanoma.^{49,50}

ETIOLOGY AND CLINICAL FINDINGS

External radiation to the cervical region at a young age is believed to be a cause of thyroid cancer.²⁰ Risk factors include thymic irradiation as a child, external medical diagnostic radiation of the neck region, multiple dental radiation exposures received before 1970, and possibly dental CT of the mandible.⁴⁹ Radiation delivered to the thyroid from internal sources and diagnostic or therapeutic doses of ^{131}I have not been associated with an increased risk for thyroid cancer.⁴⁹ An increased risk for the



FIG 16.15 **A**, A 9-year-old girl with severe hypothyroidism. **B**, The same patient 1 year after treatment with thyroid hormone replacement. Note the return to normal facial appearance. (From Neville B, Damm D, Alley C, et al: *Oral and maxillofacial pathology*, ed 3, St. Louis, 2009, Saunders.)

development of thyroid cancer in patients with thyroiditis had been reported.⁵¹ Environmental factors such as high dietary iodine intake (associated with papillary cancer) or a very low iodine intake (associated with follicular cancer) appear to increase the risk for thyroid cancer.⁴⁹ A genetic factor is suggested by an increased risk for thyroid cancer when a family member has had thyroid cancer or MEN2.^{11,16,20,49,52}

On physical examination, manifestations of thyroid malignancy, including firm consistency of the nodule, irregular shape, fixation to underlying or overlying tissue, and suspicious regional lymphadenopathy.^{11,16,20,49,52} Signs and symptoms that may be associated with thyroid cancer include a lump in the region of the gland, a dominant nodule(s) in multinodular goiter, a hard painless mass, fixation to adjacent structures, enlarged cervical lymph nodes, a rapidly growing mass, hemoptysis, dysphagia, stridor, and hoarseness.⁴⁹

LABORATORY AND DIAGNOSTIC FINDINGS

The cornerstone for the diagnosis of thyroid nodules is ultrasonography and fine-needle aspiration biopsy (FNAB).⁵³ Clinically detected nodules should be evaluated by ultrasonography. Hypoechoic nodules should be submitted for FNAB (Fig. 16.16). Gray-scale sonographic features are helpful for the differential diagnosis of nodules in patients with diffuse thyroid diseases.⁵⁴ Ultrasound



FIG 16.16 Fine-needle aspiration of a thyroid nodule is the investigation of choice in a patient with a solitary nodule of the thyroid. (From Forbes CD, Jackson WF: *Color atlas and text of clinical medicine*, ed 3, Edinburgh, 2003, Mosby.)

imaging also can be used in cases of nonpalpable nodules to guide FNAB. Overall rates of sensitivity and specificity for FNAB of thyroid nodules exceed 90% in iodine-sufficient areas.⁵³ The procedure is easy to perform and relatively safe.⁴⁹ An accurate biopsy report is based on obtaining three to six aspirated samples, which should contain at least five or six groups of 10 to 15 well-preserved cells.^{49,53} Nodules found in patients living in iodine-deficient areas may require surgical removal before a diagnosis can be established.⁴⁹

MEDICAL MANAGEMENT

For most papillary carcinomas, surgery is indicated.^{16,20,52,55} Options include lobectomy and total thyroidectomy.⁴⁹ Radioiodine ablation of residual thyroid tissue does not improve survival but does allow for interpretation of thyroglobulin levels.⁴⁹ Radioiodine ablation is useful in metastatic disease and locally invasive disease and in cases in which cervical lymph nodes cannot be resected.⁴⁹ Suppression of levothyroxine can be used to limit thyrotropin stimulation of tumor growth, but adverse effects may be difficult for the patient to tolerate.⁴⁹

Treatment of follicular carcinomas involves surgery followed by radioiodine ablation and lifelong thyrotropin suppression achieved through levothyroxine replacement therapy.^{21,53} Initial surgery may consist of thyroid lobectomy or total thyroidectomy.⁴⁹ Other available options for minimally invasive disease include lobectomy and levothyroxine suppression of thyrotropin secretion alone; if cancer recurs, the rest of the thyroid is surgically removed, and radioiodine scanning for recurrence or radioiodine ablation of remaining thyroid tissue is performed.⁴⁹ Treatment of Hürthle cell cancers and medullary carcinomas is described elsewhere.

Complications associated with total or subtotal thyroidectomy are hypoparathyroidism, recurrent laryngeal nerve damage, hemorrhage, and general risks associated with surgery.^{16,20,52,55} Complications of external-beam radiotherapy include damage to the spinal cord, skin damage, and mucosal ulceration.⁴⁹ Complications associated with chemotherapy include nausea and vomiting, mucosal damage, hair loss, infection, and bleeding (see Chapter 26).⁴⁹

Prognosis. The prognosis for differentiated cancers is based on age of the patient, metastases, and extent and size of the lesion. The best outcome is projected for young people with localized cancers that are smaller than 2 cm.²⁰ Overall 10-year survival rates for papillary carcinoma are 80% to 90%; for follicular carcinoma, they are 65% to 75%; and for medullary carcinoma, 60% to 70%.⁴⁹ Involvement of cervical nodes predicts recurrence in older patients (older than 45 years) but does not predict overall survival. In patients with distant metastases of a differentiated carcinoma, the long-term survival rate is 43%. The prognosis for anaplastic carcinoma is very poor, and 5-year survival is rare (see Table 16.4).⁴⁹

DENTAL MANAGEMENT

Medical Considerations

Identification. Palpation and inspection of the thyroid gland should be included as part of the routine head and neck examination performed by the dentist.^{56,57} The anterior neck region should be inspected for indications of old surgical scars, and the posterior dorsal region of the tongue should be examined for a nodule, which could represent lingual thyroid tissue. Also, the area just superior

and lateral to the thyroid cartilage should be palpated for the presence of a pyramidal lobe. Although difficult to detect, the normal thyroid gland can be palpated in many patients.⁵⁷ It may feel rubbery and may be more easily identified by having the patient swallow during the examination. As the patient swallows, the thyroid rises; lumps in the neck that may be associated with it also rise (move superiorly). Nodules in the midline area of the thyroglossal duct move upward with protrusion of the patient's tongue.⁵⁷

An enlarged thyroid gland caused by hyperplasia (goiter) feels softer than the normal gland. Adenomas and carcinomas involving the gland are firmer on palpation and are usually seen as isolated swellings but may appear as multinodular growth. In patients with Hashimoto disease or Riedel thyroiditis, the gland is much firmer than normal.⁵⁷ If a diffuse enlargement of the thyroid is detected, auscultation should be used to examine for a systolic or continuous bruit that can be heard over the hyperactive gland of thyrotoxicosis or Graves disease as a result of engorgement of the gland's vascular system. If a thyroid abnormality is detected, even if the patient may appear euthyroid, a referral should be made for medical evaluation before dental treatment is rendered. Timely intervention originating in the dental office can help reduce the morbidity and mortality associated with thyroid disease.^{7,9,58}

Risk Assessment. Risk assessment of thyroid disease is determined based on the presence or absence of signs and symptoms, clinical features, recent thyroid function tests, and consultation with the physician. Persons undiagnosed or poorly treated hyperthyroid disease and affected older adults are at higher risk for adverse consequences of dental treatment (Box 16.3).

Thyrotoxicosis

Recommendations

Antibiotics and Risk of Infection. Chronic infection should be treated as in any other patient; that is, patients with extensive dental caries or periodontal disease should be treated after medical management of the thyroid problem has been instituted. If acute oral infection occurs in a patient with uncontrolled hyperthyroid disease, consultation with the patient's physician is recommended before initiated dental therapy (Box 16.4).^{56,59}

Bleeding. There is little to no risk of bleeding abnormalities in patients with hyperthyroidism except in patients concurrently taking warfarin and propylthiouracil.

Capacity to Tolerate Care. When a thyrotoxic patient is under good medical management, dental treatment can proceed without alteration. However, patients with untreated or poorly treated thyrotoxicosis are susceptible to developing an acute medical emergency, called *thyrotoxic crisis (thyroid storm)*.⁷ Clinical manifestations include restlessness, fever, tachycardia, pulmonary edema, tremor, sweating, stupor, and, finally, coma and death, if treatment is not provided. Of note, dental surgery performed in these patients may precipitate a thyrotoxic crisis.⁷ In

BOX 16.3 Medical Problems Potentially Encountered in or Associated With Dental Treatment of Patients With Undiagnosed or Poorly Controlled Thyroid Disease

Hyperthyroidism

Adverse interaction with epinephrine
 Life-threatening cardiac arrhythmias
 Congestive heart failure
 Complications of underlying cardiovascular pathologic conditions
 Thyrotoxic crisis can be precipitated by:

- Infection
- Surgical procedures

Hypothyroidism

Exaggerated response to CNS depressants:

- Sedatives
- Narcotic analgesics

Myxedematous coma can be precipitated by:

- CNS depressants
- Infection
- Surgical procedures

CNS, Central nervous system.

addition, acute oral infection has been associated with such events.

Drug Considerations. Use of epinephrine or other pressor amines (in local anesthetics or gingival retraction cords or to control bleeding) must be avoided in untreated or poorly treated thyrotoxic patients. However, well-managed (euthyroid) thyrotoxic patients with thyroid disease require no special consideration in this regard and may be given normal concentrations of these vasoconstrictors.⁵⁷ Care must be taken with patients whose disease is being brought under control when the dentist plans to use nonselective beta-blockers. When epinephrine is given to these patients, it is possible that blood pressure can be increased through inhibition of the vasodilatory action of epinephrine attained through blocking of β_2 receptors.⁵⁶ Clinical experience has shown that small amounts of epinephrine can be used safely in euthyroid patients. Use of more concentrated preparations of epinephrine (as in retraction cords and preparations used to control bleeding) should be avoided (see Chapter 3).

Adverse reactions to propylthiouracil include agranulocytosis and leukopenia (see Box 16.2). If these occur, the patient is at risk for serious infection. The physician should monitor the patient for these adverse reactions. The dentist can consult with the patient's physician or can order a complete blood count to rule out the presence of these complications before undertaking surgical procedures. It has been reported that propylthiouracil can induce sialolith formation. This drug also can increase the anticoagulant effects of warfarin. Aspirin and other nonsteroidal antiinflammatory drugs can increase the

amount of circulating T_4 , making control of thyroid disease more difficult.⁵⁶

Emergencies. If a thyrotoxic crisis occurs, the dentist must recognize the features, begin emergency treatment, and seek immediate medical assistance (see Box 16.4). The patient can be cooled with cold towels, given an injection of hydrocortisone (100–300 mg), and started on an IV infusion of hypertonic glucose (if equipment is available). Vital signs must be monitored and cardiopulmonary resuscitation initiated, if necessary. Immediate medical assistance should be sought, and when available, other measures such as antithyroid drugs and potassium iodide may be started.^{7,9,58}

Hypothyroidism

Identification. Patients with hypothyroidism should be identified when possible because their quality of life can be greatly improved with medical treatment. With detection early in childhood, permanent mental retardation can be avoided with appropriate medical management. In addition, oral complications of delayed eruption of teeth, malocclusion, enlarged tongue, and skeletal retardation can be prevented through early detection and medical treatment.⁶⁰

Recommendations

Antibiotics and Risk of Infection. Acute oral infection in an uncontrolled hypothyroid patient could trigger a myxedema coma; such a patient should receive immediate consultation with the patient's physician as part of the management program (see Box 16.4).

Bleeding. There is little to no risk of bleeding abnormalities in patients with hypothyroidism.

Capacity to Tolerate Care. In general, patients with mild symptoms of untreated hypothyroidism are not in danger when receiving dental therapy. Also, when hypothyroid patients are under good medical care, no special problems in terms of dental management remain. However, patients with untreated severe symptoms of hypothyroidism may be in danger if dental treatment is rendered (see Box 16.3). This is particularly true of patients with poorly controlled disease who have infection and older adults with myxedema. A myxedematous coma can be precipitated by CNS depressants, surgical procedures, and infections; thus, the major concerns of dental management of patients with this condition are detection and referral for medical management before any dental treatment is rendered (see Box 16.4).

Drug Considerations. CNS depressants, sedatives, and narcotic analgesics may cause an exaggerated response in patients with mild to severe hypothyroidism. These drugs must be avoided in all patients with severe hypothyroidism and must be used with care (reduced dosage) in patients with mild hypothyroidism.^{11,28,59}

Emergencies. If myxedema coma occurs, the dentist should call for medical aid; while waiting for this assistance, the dentist can inject 100 to 300 mg of hydrocortisone, cover the patient to conserve heat, and apply

BOX 16.4 Dental Management Considerations in Patients With Thyroid Disease

P**Patient Evaluation and Risk Assessment (See Box 1.1)**

- Evaluate and determine whether a hyper-, hypo-, or euthyroid condition exists.
- Obtain medical consultation if poorly controlled or undiagnosed problem or if uncertain.

Potential Issues and Factors of Concern*Hyperthyroid Patients***A**

Analgesics	Aspirin and other NSAIDs can increase the amount of circulating T ₄ , making control of thyroid disease more difficult. Use appropriately.
Antibiotics	Ciprofloxacin should not be taken simultaneously with levothyroxine because the antibiotic appears to decrease absorption of the thyroid hormone.
Anesthesia	Avoid using epinephrine in local anesthetics in untreated and poorly controlled patients.
Anxiety	Patients with untreated or poorly controlled disease may appear very anxious.

B

Bleeding	Excessive bleeding may occur in patients with untreated or poorly controlled disease owing to thrombocytopenia, which, fortunately, is not a common finding.
Breathing	No issues
Blood pressure	Monitor blood pressure because it may be elevated in patients with untreated or poorly controlled disease.

C

Chair position	No issues
Cardiovascular	Patients with untreated or poorly controlled disease may be subject to arrhythmias.

D

Drugs	The use of epinephrine or other pressor amines (gingival retraction cords or to control bleeding) must be avoided in untreated or poorly treated thyrotoxic patients. Common side effects of the antithyroid drugs (methimazole and propylthiouracil) are rash, pruritus, fever, and arthralgias. Agranulocytosis and hepatitis are rare but serious complications of the antithyroid drugs.
-------	--

E

Equipment	No issues
Emergencies	Patients taking antithyroid drugs who develop fever, sore throat, or oral ulcerations should seek urgent medical care (possible agranulocytosis). Patients who develop jaundice and abdominal pain (possible hepatitis) should seek urgent medical care.

Thyrotoxic crisis occurring in the dental office:

Seek medical aid; vital signs must be monitored and CPR initiated if necessary; apply wet packs or ice packs; inject 100 to 300 mg of hydrocortisone, IV glucose solution; administer propylthiouracil; and transport patient to emergency medical facilities.

F

Follow-up	Routine unless patient develops complications
-----------	---

*Hypothyroid Patients***A**

Analgesics	Avoid CNS depressants such as narcotics, barbiturates, and sedatives in patients with poorly controlled disease.
Antibiotics	In patients with poorly controlled as well as well-controlled disease, treat acute infection aggressively using appropriate antibiotics and incision and drainage when indicated.
Anesthesia	No issues
Anxiety	Avoid CNS depressants such as narcotics, barbiturates, and sedatives in patients with poorly controlled disease.

B

Bleeding	No issues
Breathing	No issues
Blood pressure	No issues

C

Chair position	No issues
Cardiovascular	No issues

D

Devices	No issues
Drugs (drug actions and interactions)	Phenytoin, phenobarbital, carbamazepine, and rifampin should be used with care because they increase the metabolism of thyroid replacement drugs. Ferrous sulfate, calcium carbonate, and aluminum hydroxide can interfere with thyroxine absorption (thyroxine doses should be separated from ingestion of these substances by 4 or more hours).

E

Equipment	No issues
Emergencies	Myxedema coma: Seek medical aid; vital signs must be monitored and CPR initiated if necessary. Cover patient to conserve body heat; inject 100 to 300 mg of hydrocortisone, thyroxine (1.8 µg/kg daily with a 500-µg loading dose), IV saline, and glucose; transport to medical emergency facility.

F

Follow-up	Routine unless patient develops complications
-----------	---

cardiopulmonary resuscitation if indicated. When medical aid becomes available, parental levothyroxine is administered, and IV hypertonic saline and glucose are given as needed.¹

ORAL MANIFESTATIONS

Hyperthyroidism

In children, the teeth and jaws develop rapidly, and premature loss of deciduous teeth with early eruption of permanent teeth is common. Euthyroid infants of hyperthyroid mothers have been reported to have erupted teeth at birth. A few patients with thyrotoxicosis have been found to have a lingual “thyroid” consisting of thyroid tissue posterior to the foramen cecum (Fig. 16.17).^{32,33} If the dentist detects a lingual thyroid, assessment by a physician is required before the mass is considered for

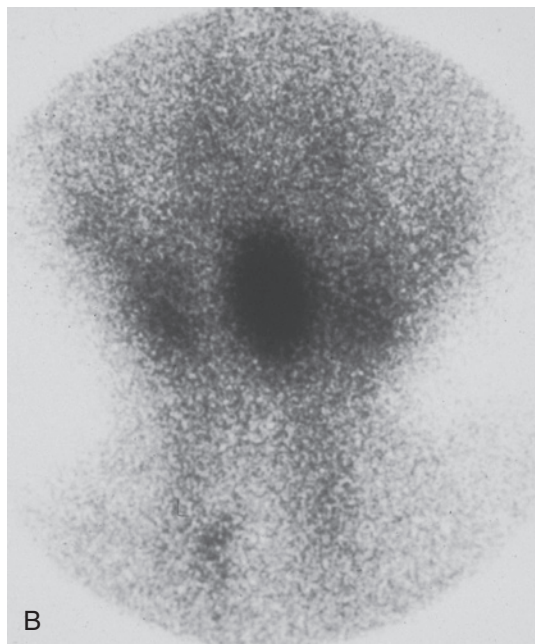
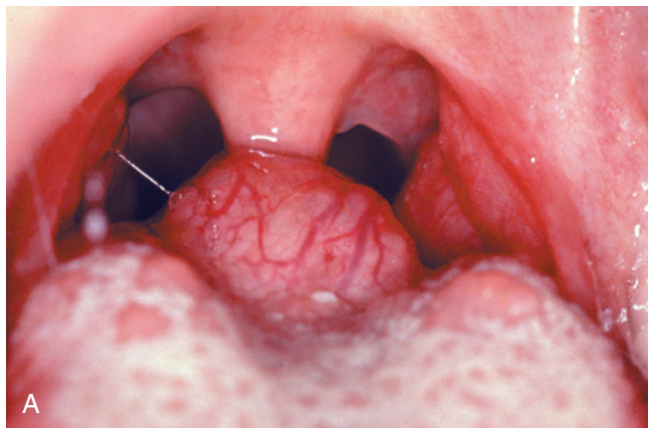

FIG 16.17 A, Lingual thyroid nodule in a 4-year-old girl. **B**, Thyroid scan of the nodule. (From Neville BW, et al: *Oral and maxillofacial pathology*, ed 3, St. Louis, 2009, Saunders.)

surgical removal. This usually is done with RAI scanning.^{57,61} Osteoporosis involving the alveolar bone may be an associated feature, and development of dental caries and periodontal disease may occur rapidly in these patients. In very early reports, a number of changes were reported affecting taste and smell.⁶²⁻⁶⁴

Hypothyroidism

Infants with hypothyroidism may present with thick lips, enlarged tongue, and delayed eruption of teeth with resulting malocclusion. Adults with acquired hypothyroidism can display an enlarged tongue and low salivary flow.^{59,61,65,66}

Thyroiditis

Hashimoto thyroiditis can be accompanied by salivary gland dysfunction, resulting in dry mouth. This may be due to the effect of cytokines in the autoimmune process or because of thyroid hormone dysfunctions.⁶⁷ The pain associated with subacute painful thyroiditis may radiate to the ear, jaw, or occipital region. Hoarseness and dysphagia may be accompanying features. Patients may report palpitations, nervousness, and lassitude. On palpation, the thyroid is enlarged, firm, often nodular, and usually very tender.^{11,46,59}

Thyroid Disease and Lichen Planus

Studies from Finland and Sweden suggest an association between thyroid disease (i.e. hypothyroidism or its treatment) and oral lichen planus.^{68,69}

Medications. RAI used to treat hyperthyroid conditions and thyroid cancer is associated with acute and long-term risks and side effects. Acute risks include salivary gland swelling and pain and loss of taste. Longer term complications include recurrent sialoadenitis, hyposalivation, xerostomia, mouth pain, and dental caries^{70,71} (see [Chapter 26](#) and [Appendix C](#) for management of xerostomia). Antithyroid medications (propylthiouracil and methimazole) can cause agranulocytosis, which can lead to oral ulcerations or necrotizing gingivostomatitis.

REFERENCES

1. Ferri FF. Hypothyroidism. In: Ferri FF, ed. *Ferri's Clinical Advisor*. Philadelphia, PA: Elsevier (Saunders); 2015:648-655.
2. Ferri FF. Hyperthyroidism. In: Ferri FF, ed. *Ferri's Clinical Advisor*. Philadelphia, PA: Elsevier (Saunders); 2015:623-630.
3. Ferri FF. Thyroid carcinoma. In: Ferri FF, ed. *Ferri's Clinical Advisor*. Philadelphia, PA: Elsevier (Saunders); 2015:1163-1170.
4. Ferri FF. Thyroiditis. In: Ferri FF, ed. *Ferri's Clinical Advisor*. Philadelphia, PA: Elsevier (Saunders); 2015:1166-1170.
5. Ferri FF. Grave's disease. In: Ferri FF, ed. *Ferri's Clinical Advisor*. Philadelphia, PA: Elsevier (Saunders); 2015:507-530.

6. Ferri FF. Myxedema coma. In: Ferri FF, ed. *Ferri's Clinical Advisor*. Philadelphia, PA: Elsevier (Saunders); 2015:720-730.
7. Ferri FF. Thyrotoxic storm. In: Ferri FF, ed. *Ferri's Clinical Advisor*. Philadelphia, PA: Elsevier (Saunders); 2015:1171-1175.
8. Wiersinga WM. Hypothyroidism and myxedema coma. In: Jameson JL, De Groot LJ, eds. *Endocrinology: Adult and Pediatric*. 7th ed. Philadelphia PA: Elsevier (Saunders); 2016:1541-1556.
9. Kim M, Ladenson PW. Thyroid. In: Goldman L, Schafer AI, eds. *Goldman-Cecil Medicine*. Philadelphia, PA: Elsevier (Saunders); 2016:1500-1535.
10. DeFelice M, Roberto D. Anatomy and development of the thyroid gland. In: Jameson JL, De Groot LJ, eds. *Endocrinology: Adult and Pediatric*. 7th ed. Philadelphia PA: Elsevier (Saunders); 2016:1570-1580.
11. Ladenson P, Kim M. Thyroid. In: Goldman L, Ausiello D, eds. *Cecil Medicine*. 23rd ed. Philadelphia: Saunders Elsevier; 2008:1698-1712.
12. DeFelice M, DiLauro R. Anatomy and development of the thyroid. In: Jameson JL, DeGroot LJ, eds. *Endocrinology Adult and Pediatric*. Philadelphia: Saunders Elsevier; 2010:1342-1361.
13. Marinovic D, Garel C, Czernichow P, et al. Ultrasonographic assessment of the ectopic thyroid tissue in children with congenital hypothyroidism. *Pediatr Radiol*. 2004;34(2):109-113.
14. Jameson JL, Weetman AP. Diseases of the thyroid gland. In: Kasper DL, Braunwald E, Fauci AS, et al, eds. *Harrison's Online Principles of Medicine*. 16th ed. New York: McGraw-Hill; 2005:2104-2127.
15. Larsen PW, Davies TF. Hypothyroidism and thyroiditis. In: Larsen PR, Kronenberg HM, Melmed D, et al, eds. *Williams Textbook of Endocrinology*. 10th ed. Philadelphia: W.B. Saunders; 2003:415-465.
16. Jameson JL, Weetman AP. Disorders of the thyroid gland. In: Fauci AS, ed. *Harrison's Principles of Internal Medicine*. 17th ed. New York: McGraw-Hill; 2008:2224-2246.
17. Skugor M, Fliseriu M. Hypothyroidism and hyperthyroidism. In: Carey WD, et al, eds. *Current Clinical Medicine 2009 - Cleveland Clinic*. Philadelphia: Saunders Elsevier; 2009:431-439.
18. Hegedus L, Paschke R, Krohn K, et al. Multinodular goiter. In: Jameson JL, De Groot LJ, eds. *Endocrinology: Adult and Pediatric*. 7th ed. Philadelphia PA: Elsevier (Saunders); 2016:1570-1580.
19. Amino N, Lazarus JH, DeGroot LJ. Chronic (Hashimoto's) thyroiditis. In: Jameson JL, De Groot LJ, eds. *Endocrinology: Adult and Pediatric*. 7th ed. Philadelphia PA: Elsevier (Saunders); 2016:1515-1527.
20. Pacini F, et al. Thyroid neoplasia. In: Jameson JL, DeGroot LJ, eds. *Endocrinology Adult and Pediatric*. Philadelphia: Saunders Elsevier; 2010:1668-1701.
21. Pacini F, Chiofalo F, DeGroot LJ. Thyroid neoplasia. In: Jameson JL, De Groot LJ, eds. *Endocrinology: Adult and Pediatric*. 7th ed. Philadelphia PA: Elsevier (Saunders); 2016:1601-1625.
22. Germain DLS. Thyroid hormone metabolism. In: Jameson JL, DeGroot LJ, eds. *Endocrinology Adult and Pediatric*. Philadelphia: Saunders Elsevier; 2010:1409-1422.
23. Webb P, et al. Mechanisms of thyroid hormone action. In: Jameson JL, DeGroot LJ, eds. *Endocrinology Adult and Pediatric*. Philadelphia: Saunders Elsevier; 2010:1423-1443.
24. Wondisford FE. Thyroid hormone action. In: Jameson JL, De Groot LJ, eds. *Endocrinology: Adult and Pediatric*. 7th ed. Philadelphia PA: Elsevier (Saunders); 2016:1336-1370.
25. Vassant G, Kleinau G. Thyroid stimulating hormone receptor mutations. In: Jameson JL, De Groot LJ, eds. *Endocrinology: Adult and Pediatric*. 7th ed. Philadelphia PA: Elsevier (Saunders); 2016:1629-1638.
26. Marino M. Graves' disease. In: Jameson JL, DeGroot LJ, eds. *Endocrinology Adult and Pediatric*. Philadelphia: Saunders Elsevier; 2010:1527-1558.
27. Brabant G, Peeters RP, Chan SY, et al. Management of subclinical hypothyroidism in pregnancy: are we too simplistic? *Eur J Endocrinol*. 2015;173(1):P1-P11.
28. Wiersinga WM. Hypothyroidism and myxedema coma. In: Jameson JL, DeGroot LJ, eds. *Endocrinology Adult and Pediatric*. Philadelphia: Saunders Elsevier; 2010:1607-1622.
29. Guimaraes VC. Subacute and Riedel's thyroiditis. In: Jameson JL, De Groot LJ, eds. *Endocrinology: Adult and Pediatric*. 7th ed. Philadelphia PA: Elsevier (Saunders); 2016:1523-1540.
30. Schlurnberger M-J, Filetti S, Hay ID. Benign and malignant nodular thyroid disease. In: Larsen PR, Kronenberg HM, Melmed D, et al, eds. *Williams Textbook of Endocrinology*. 10th ed. Philadelphia: W.B. Saunders; 2003:465-491.
31. Institute NC. *Thyroid Cancer. SEER: Surveillance, Epidemiology and End Results*. Washington DC: National Cancer Institute; 2015.
32. Marino M, Vitti P, Chiouato L. Graves' disease. In: Jameson JL, De Groot LJ, eds. *Endocrinology: Adult and Pediatric*. 7th ed. Philadelphia PA: Elsevier (Saunders); 2016:1438-1464.
33. Dumont JE, et al. Thyroid regulatory factors. In: Jameson JL, DeGroot LJ, eds. *Endocrinology Adult and Pediatric*. Philadelphia: Saunders Elsevier; 2010:1384-1409.
34. Germain DLS. Thyroid hormone metabolism. In: DeGroot LJ, Jameson JL, eds. *Endocrinology*. 5th ed. Philadelphia: Saunders Elsevier; 2006: 1861-1873.
35. Weetman AP. Autoimmune thyroid disease. In: Jameson JL, DeGroot LJ, eds. *Endocrinology Adult and Pediatric*. Philadelphia: Saunders Elsevier; 2010:1512-1526.
36. Weiss RE, Refetoff S. Thyroid function testing. In: Jameson JL, DeGroot LJ, eds. *Endocrinology Adult and Pediatric*. Philadelphia: Saunders Elsevier; 2010:1444-1492.
37. Weiss RE, Refetoff S. Thyroid function testing. In: Jameson JL, De Groot LJ, eds. *Endocrinology: Adult and Pediatric*. 7th ed. Philadelphia PA: Elsevier (Saunders); 2016:1351-1388.
38. Blum M. Thyroid imaging. In: DeGroot LJ, Jameson JL, eds. *Endocrinology*. 5th ed. Philadelphia: Saunders Elsevier; 2006:1963-1979.

39. Blum M. Thyroid imaging. In: Jameson JL, DeGroot LJ, eds. *Endocrinology Adult and Pediatric*. Philadelphia: Saunders Elsevier; 2010:1493-1512.
40. Janegova A, Janega P, Rychly B, et al. The role of Epstein-Barr virus infection in the development of autoimmune thyroid diseases. *Endokrynol Pol*. 2015;66(2):132-136.
41. Weetman AP. Graves' disease. *N Engl J Med*. 2000;343(17):1236-1248.
42. Burch HB, Bahn RS. Graves' ophthalmopathy. In: Jameson JL, DeGroot LJ, eds. *Endocrinology Adult and Pediatric*. Philadelphia: Saunders Elsevier; 2010:1559-1571.
43. Krassas G, Karras SN, Pontikides N. Thyroid diseases during pregnancy: a number of important issues. *Hormones (Athens)*. 2015;14(1):59-69.
44. Giacobbe AM, Grasso R, Triolo O, et al. Thyroid diseases in pregnancy: a current and controversial topic on diagnosis and treatment over the past 20 years. *Arch Gynecol Obstet*. 2015;292(5):995-1002.
45. Saver DF, Pollak EF, McCartney C, et al. *Thyroiditis*. Elsevier; 2004. <http://www.firstconsult.com>. Accessed 30 October 2004.
46. Guimaraes VC. Subacute and Riedel's thyroiditis. In: Jameson JL, DeGroot LJ, eds. *Endocrinology Adult and Pediatric*. Philadelphia: Saunders Elsevier; 2010:1595-1606.
47. Lazarus JH. Chronic (Hashimoto's) thyroiditis. In: Jameson JL, DeGroot LJ, eds. *Endocrinology Adult and Pediatric*. Philadelphia: Saunders Elsevier; 2010:1583-1593.
48. Virgini VS, Wijsman LW, Rodondi N, et al. Subclinical thyroid dysfunction and functional capacity among elderly. *Thyroid*. 2014;24(2):208-214.
49. Saver DF, Scherger JE, Pearson RL, et al. *Thyroid carcinoma*. Elsevier; 2004. <http://www.firstconsult.com>. Accessed 30 October 2004.
50. Wood K, Vini L, Harmer C. Metastases to the thyroid gland: the Royal Marsden experience. *Eur J Surg Oncol*. 2004;30(6):583-588.
51. Liu CL, Cheng SP, Lin HW, et al. Risk of thyroid cancer in patients with thyroiditis: a population-based cohort study. *Ann Surg Oncol*. 2014;21(3):843-849.
52. Weigel RJ, Macdonald JS, Haller D. Cancer of the endocrine system. In: Abeloff MD, Armitage JO, Niederhuber JE, et al, eds. *Clinical Oncology*. 3rd ed. London: Churchill Livingstone; 2004:1612-1621.
53. Olson MT, Zeiger MA. Thyroid fine-needle aspiration and cytological diagnosis. In: Jameson JL, De Groot LJ, eds. *Endocrinology: Adult and Pediatric*. 7th ed. Philadelphia PA: Elsevier (Saunders); 2016:1418-1422.
54. Yan Z, Yu-Kun L, Jie T, et al. Clinical value of ultrasonography in diagnosing diffuse thyroid diseases accompanied with suspicious nodules. *Zhongguo Yi Xue Ke Xue Yuan Xue Bao*. 2015;37(3):290-293.
55. McHenry CR. Thyroid cancer. In: Rakel RE, Bope ET, eds. *Conn's Current Therapy*. 53rd ed. Philadelphia: Saunders Elsevier; 2006.
56. Pinto A, Glick M. Management of patients with thyroid disease: oral health considerations. *J Am Dent Assoc*. 2002;133(7):849-858.
57. Little JW. Thyroid disorders: Part I, hyperthyroidism. *Oral Surg Oral Med Oral Pathol Oral Radiol Endod*. 2006;101(3):276-284.
58. Little JW. Thyroid disorders: Part III, thyroid neoplasms. *Oral Surg Oral Med Oral Pathol Oral Radiol Endod*. 2006;102(3):275-280.
59. Little JW. Thyroid disorders: Part II, hypothyroidism and thyroiditis. *Oral Surg Oral Med Oral Pathol Oral Radiol Endod*. 2006;102(2):148-153.
60. Little JW. Thyroid disease. In: Little JW, Falace DA, Miller CS, et al, eds. *Dental Management of the Medically Compromised Patient*. 6th ed. St. Louis: Mosby; 2002:283-303.
61. Neville BW, Damm DD, Allen CA, et al. *Oral & Maxillofacial Pathology*. 2nd ed. Philadelphia: W.B. Saunders; 2002.
62. McConnell RJ, Menendez CE, Smith FR, et al. Defects of taste and smell in patients with hypothyroidism. *Am J Med*. 1975;59(3):354-364.
63. Rivlin RS, Osnos M, Rosenthal S, et al. Abnormalities in taste preference in hypothyroid rats. *Am J Physiol*. 1977;232(1):E80-E84.
64. Coll J, Anglada J, Tomas S, et al. High prevalence of subclinical Sjogren's syndrome features in patients with autoimmune thyroid disease. *J Rheumatol*. 1997;24(9):1719-1724.
65. Neville BW, Damm DD, Allen CM, et al. Hyperthyroidism (thyrotoxicosis; Graves' disease). In: Neville BW, Damm DD, Allen CM, et al, eds. *Oral and Maxillofacial Pathology*. 4th ed. St. Louis, MO: Elsevier; 2016.
66. Neville BW, Damm DD, Allen CM, et al. Hypothyroidism (cretinism; myxedema). In: Neville BW, Damm DD, Allen CM, et al, eds. *Oral and Maxillofacial Pathology*. 4th ed. St. Louis, MO: Elsevier; 2016.
67. Agha-Hosseini F, Shirzad N, Moosavi MS. Evaluation of xerostomia and salivary flow rate in Hashimoto's thyroiditis. *Med Oral Patol Oral Cir Bucal*. 2016;21(1):e1-e5.
68. Siponen M, Huuskonen L, Laara E, et al. Association of oral lichen planus with thyroid disease in a Finnish population: a retrospective case-control study. *Oral Surg Oral Med Oral Pathol Oral Radiol Endod*. 2010;110(3):319-324.
69. Robledo-Sierra J, Landin-Wilhelmsen K, Nystrom HF, et al. Clinical characteristics of patients with concomitant oral lichen planus and thyroid disease. *Oral Surg Oral Med Oral Pathol Oral Radiol*. 2015;120(5):602-608.
70. Grewal RK, Larson SM, Pentlow CE, et al. Salivary gland side effects commonly develop several weeks after initial radioactive iodine ablation. *J Nucl Med*. 2009;50(10):1605-1610.
71. Lee SL. Complications of radioactive iodine treatment of thyroid carcinoma. *J Natl Compr Canc Netw*. 2010;8(11):1277-1287.
72. Hueston WJ. Hyperthyroidism. In: Bope ET, Kellerman RD, eds. *Conn's Current Therapy*. Philadelphia, PA: Elsevier (Saunders); 2015:768-770.

Women's Health Issues

DEFINITION

Women's health is altered by pregnancy and by diseases unique to female anatomy and physiology. This chapter focuses on common conditions of women that require recognition and management by dental providers to improve women's health and avoid serious complications.

PREGNANCY

A pregnant patient poses a unique set of management considerations for the dentist. Dental care must be rendered to the mother without adversely affecting the developing fetus, and although routine dental care of pregnant patients is generally safe, the delivery of dental care involves some potentially harmful elements, including the use of ionizing radiation and drug administration. Thus, prudent practitioners must balance the beneficial aspects of dentistry while minimizing or avoiding exposure of the patient (and the developing fetus) to potentially harmful procedures.

Additional considerations arise during the postpartum period if the mother elects to breastfeed her infant. Although most drugs are only minimally transmitted from maternal serum to breast milk, and the infant's exposure is not significant, the dentist should avoid using any drug that is known to be harmful to infants.

Approximately 6 million babies were born in 2014 in the United States.^{1,2} That means that approximately 4 million women are pregnant in the United States at any given time. A typical dental practice serving 2000 patients will have approximately 15 pregnant patients.

The pregnancy rate for women in the United States continued to decline in 2013, to 98.7 per 1000 women aged 15 to 44 years a record low for since 1976.^{1,2} This level was 15% below the 1990 peak (115.8 per 1000). The decline in the overall pregnancy rate included reductions in birth and abortion rates, with the percent decline greater for abortions (35%) than births (10%) over this period. The 2013 abortion rate (17.7) was also a record low.^{1,2}

The average age of women having their first child was a record high of 26 years old in 2013, according to the Centers for Disease Control and Prevention's (CDC's) National Vital Statistics Report. That's an increase of 3.3 years since 1980, when the average age was 22.7. Most of the change took place between 1980 and 2000, when the average rose to 24.9. It stayed relatively stable around

25 until 2008, when it started climbing again to its current high.²

PATHOPHYSIOLOGY AND COMPLICATIONS

Endocrine changes are the most significant basic alterations that occur with pregnancy. They result from the increased production of maternal and placental hormones and from modified activity of target end organs.^{1,3-8}

Fatigue is a common physiologic finding during the first trimester that may have a psychological impact. A tendency toward syncope and postural hypotension may be present. During the second trimester, patients typically have a sense of well-being and relatively few symptoms.^{1,3-8} During the third trimester, increasing fatigue and discomfort and mild depression may be reported. Several cardiovascular changes occur as well. Blood volume increases by 40% to 50%, and cardiac output increases by 30% to 50%, but red blood cell (RBC) volume increases by only about 15% to 20%, resulting in a fall in the maternal hematocrit.^{1,3} Despite the increase in cardiac output, blood pressure falls (usually to $\leq 100/70$ mm Hg) during the second trimester, and a modest increase is noted in the last month of pregnancy. This increase in blood volume is associated with high-flow, low-resistance circulation; tachycardia; and heart murmurs, and it may unmask glomerulopathies, peripartum cardiomyopathy, arterial aneurysms, or arteriovenous malformations.^{1,3-8} A benign systolic ejection murmur is one of the more common findings in more than 90% of pregnant women, which disappears shortly after delivery.^{1,3-8} A murmur of this type is considered physiologic or functional. However, a murmur that preceded pregnancy or persisted after delivery would require further evaluation for determination of its significance.

During late pregnancy, a phenomenon known as *supine hypotensive syndrome* may occur that manifests as an abrupt fall in blood pressure, bradycardia, sweating, nausea, weakness, and air hunger when the patient is in a supine position.^{1,3-8} Symptoms are caused by impaired venous return to the heart that results from compression of the inferior vena cava by the gravid uterus. This leads to decreased blood pressure, reduced cardiac output, and impairment or loss of consciousness. The remedy for the problem is to roll the patient over onto her left side, which lifts the uterus off the vena cava. Blood pressure should rapidly return to normal.

Blood changes in pregnancy include anemia and a decreased hematocrit value. Anemia occurs because blood volume increases more rapidly than RBC mass. As a result, a fall in hemoglobin and a marked need for additional folate and iron occur. The majority of pregnant women have insufficient iron stores, a problem that is exaggerated by significant blood loss. However, there is disagreement over whether or not to routinely provide iron supplementation.^{1,3-8} Although changes in platelets are usually clinically insignificant, most studies show a mild decrease in platelets during pregnancy.^{1,3-8} Several blood clotting factors, especially fibrinogen and factors VII, VIII, IX, and X, are increased. As a result of the increase in many of the coagulation factors, combined with venous stasis, pregnancy is associated with a hypercoagulable state. Interestingly, however, the prothrombin time, activated partial thromboplastin time, and thrombin time all fall slightly but remain within the limits of normal nonpregnant values.^{1,3-8} The overall risk of thromboembolism in pregnancy is estimated to be 1 in 1500 and accounts for 25% of maternal deaths in the United States.¹

Several white blood cell (WBC) and immunologic changes occur. The WBC count increases progressively throughout pregnancy primarily because of an increase in neutrophils and is nearly doubled by term. The reason for the increase is unclear, but it may be due to elevated estrogen and cortisol levels.⁵ This increase of neutrophils may complicate the interpretation of the complete blood count during infection. Also, during pregnancy, the immune system shifts from helper T-cell 1 (TH1) dominance to TH2 dominance. This leads to immune suppression. Clinically, the decrease in cellular immunity leads to increased susceptibility to intracellular pathogens such as cytomegalovirus virus, herpes simplex virus, varicella, and malaria.^{1,4} The decrease in cellular immunity may explain why rheumatoid arthritis frequently improves during gestation because it is a cell-mediated immunopathologic disease.⁴ During the postpartum period, rebound and heightened inflammatory activity occur.

Changes in respiratory function during pregnancy include elevation of the diaphragm, which decreases the volume of the lungs in the resting state, thereby reducing total lung capacity by 5% and the functional residual capacity (FRC), the volume of air in the lungs at the end of quiet exhalation, by 20%.⁴ Interestingly, the respiratory rate and vital capacity remain unchanged. These ventilatory changes produce an increased rate of respiration (tachypnea) and dyspnea that is worsened by the supine position. Thus, it is not surprising that sleep during pregnancy is impaired, especially during the third trimester.⁴

Pregnancy predisposes the expectant mother to an increased appetite and often a craving for unusual foods. As a result, the diet may be unbalanced, high in sugars, or nonnutritious. This can adversely affect the mother's dentition and contribute to significant weight gain. Taste alterations and an increased gag response are also common. The pH and production of saliva are probably unchanged.

No evidence exists that pregnancy causes or accelerates the course of periodontal disease or dental caries.⁹⁻¹⁴ Nausea and vomiting, or "morning sickness," complicate up to 70% of pregnancies. Typical onset is between 4 and 8 weeks' gestation, with improvement before 16 weeks; however, 10% to 25% of women still experience symptoms at 20 to 22 weeks' gestation, and some women experience this throughout the pregnancy.⁶ The cause is not well understood. Some patients may have extreme nausea and vomiting, which can be a cause of dental erosion.

The general pattern of fetal development should be understood when dental management plans are being formulated. Normal pregnancy lasts approximately 40 weeks. During the first trimester, organs and systems are formed (organogenesis).¹ Thus, fetuses are most susceptible to malformation during this period. After the first trimester, the majority of formation is complete, and the remainder of fetal development is devoted primarily to growth and maturation. Thus, the chances of malformation are markedly diminished after the first trimester.¹ A notable exception to this is the fetal dentition, which is susceptible to malformation from toxins or radiation and to tooth discoloration caused by administration of tetracycline.

Complications of pregnancy are infrequent when prenatal care is provided and the mother is healthy. Unfortunately, complications occur more often in expectant mothers who harbor pathogens (oral and extraoral) and smoke and in nonwhites over whites in the United States.^{1,4,7} Common complications include infection, inflammatory response, glucose abnormalities, and hypertension.^{1,4,7} Each increases the risks for preterm delivery, perinatal mortality, and congenital anomalies. Insulin resistance is a contributing factor to the development of gestational diabetes mellitus (GDM), which occurs in 2% to 6% of pregnant women. GDM increases the risks for infection and large birth weight babies. Hypertension is of particular interest because it can lead to end-organ damage or preeclampsia, a clinical condition of pregnancy that manifests as hypertension, proteinuria, edema, and blurred vision.^{1,7,8} Preeclampsia (hypertension with proteinuria) progresses to eclampsia, a life-threatening condition, if seizures or coma develop. The cause of eclampsia is unknown but appears to involve sympathetic overactivity associated with insulin resistance, the renin-angiotensin system, lipid peroxidation, and inflammatory mediators.^{1,7,8} Complications of pregnancy that are unresponsive to diet modification and palliative care ultimately require drugs or hospitalization for adequate control.

Another consideration related to fetal growth is spontaneous abortion (miscarriage). Spontaneous abortion is the natural termination of pregnancy before the 20th week of gestation; it occurs in approximately 15% of all pregnancies.⁴ The most common causes of spontaneous abortion are morphologic or chromosomal abnormalities

that prevent successful implantation. It is most unlikely that any dental procedure would be implicated in spontaneous abortion, provided fetal hypoxia and exposure of the fetus to teratogens are avoided. Febrile illness and sepsis also can precipitate a miscarriage; therefore, prompt treatment of odontogenic infection and periodontitis is advised.^{1,4,8}

Because of immature liver and enzyme systems, fetuses have a limited ability to metabolize drugs. Pharmacologic challenge of fetuses is to be avoided when possible.

During the postpartum period, the mother may suffer from lack of sleep and postpartum depression. Also during the postpartum period, risks for autoimmune disease, particularly rheumatoid arthritis, multiple sclerosis, and thyroiditis, are increased.

DENTAL MANAGEMENT

Management recommendations during pregnancy should be viewed as general guidelines, not immutable rules. The dentist should assess the general health of the patient through a thorough medical history. Inquiries should be made regarding the patient's current physician; medications taken; use of tobacco, alcohol, or illicit drugs; history of GDM; miscarriage; hypertension; and morning sickness. If the need arises, the patient's obstetrician should be consulted, particularly with the use of certain medications (Box 17.1).

Pregnancy is a special event in a woman's life; hence, it is an emotionally charged experience. Establishing a good patient–dentist relationship that encourages openness, honesty, and trust is an integral part of successful management. This kind of relationship greatly reduces stress and anxiety for both the patient and dentist.

As with all patients, measuring vital signs is important for identifying undiagnosed abnormalities and the need for corrective action. At a minimum, blood pressure and pulse should be measured. Systolic pressure at or above 140 mm Hg and diastolic pressure at or above 90 mm Hg are signs of hypertension (see Chapter 3). Also, there is concern if a patient's blood pressure increases 30 mm or more systolic or an increase of 15 mm Hg in diastolic blood pressure compared with prepregnancy values because this can be a sign of preeclampsia.^{4,7} Confirmed hypertensive values dictate that the patient should be referred to a physician to ensure that preeclampsia and other cardiovascular disorders are properly diagnosed and managed.

Preventive Program. An important objective in planning dental treatment for a pregnant patient is to establish a healthy oral environment and an optimum level of oral hygiene. This essentially consists of a plaque control program that minimizes the exaggerated inflammatory response of gingival tissues to local irritants that commonly accompany the hormonal changes of pregnancy.⁹ It has been speculated that periodontal disease is a risk factor

BOX 17.1 Dental Management Considerations for Pregnant Patients

P Patient Evaluation and Risk Assessment (see Box 1.1)		Blood pressure	
Potential Issues or Concerns		Watch for supine hypotension if patient is in the supine position, most likely in late third trimester. Roll patient on left side if hypotension occurs.	
A		C	
Antibiotics	If antibiotics are required, consult with the physician. Use those with FDA classification A or B unless otherwise approved by the physician.	Chair position	Patient may not be able to tolerate a supine chair position in the third trimester
Analgesics	If analgesics are required, consult with the physician. Acetaminophen is the drug of choice. If other analgesics are required, use with approval of physician.	Cardiovascular	Elevated BP could be a sign of preeclampsia; refer to physician for follow-up care.
Anesthesia	The usual local anesthetics with vasoconstrictors are safe to use, provided care is taken not to exceed the recommended dose.	D	
Anxiety	Avoid the use of most anxiolytics. Short-term use of nitrous oxide can be used, if needed, provided 50% oxygen is used.	Drugs	Avoid all drugs, if possible. If drugs are needed, use FDA category A or B if possible.
B		E	
Bleeding	No issues	Equipment	Take only necessary radiographs; use a lead apron and thyroid collar.
Breathing	Patient may have difficulty breathing in the supine position.	Emergencies	Anticipate the possibility of supine hypotension if in the third trimester.
		F	
		Follow-up	Patient should have teeth cleaned during pregnancy and be advised of importance of health and baby's oral health and not to put the baby to bed with a bottle.

BP, Blood pressure; FDA, Food and Drug Administration.

for preeclampsia and preterm, low birth weight; however, recent reviews do not support this contention.^{10,11} Maternal plaque control, however, has implications for caries risk for infants. Studies conducted over the past 30 years have shown that reduced oral streptococcal levels in a pregnant mother reduce the risk that her infant will become infected and develop caries.¹¹⁻¹⁴

Acceptable oral hygiene techniques should be taught, reinforced, and monitored. Diet counseling, with emphasis on limiting the intake of refined carbohydrates and carbonated soft drinks, should be provided. Coronal scaling and polishing or root curettage may be performed whenever necessary. Preventive plaque control measures should be provided and emphasized throughout pregnancy, including the first trimester, for benefit to the pregnant mother and the developing baby.^{3,10} Chlorhexidine 0.12% mouth rinse may be used safely during pregnancy, if needed.³

The benefits of prenatal fluoride are controversial. Early studies by Glenn¹⁵ and Glenn and associates¹⁶ concluded that a daily 2.2-mg tablet of sodium fluoride administered to mothers during the second and third trimesters in combination with fluoridated water resulted in 97% of the offspring being caries free for up to 10 years. Not only were medical or dental defects, including fluorosis, absent in these children, but an association with decreased premature delivery and increased birth weight was seen in the fluoride treatment group. However, in a later randomized controlled trial of 798 children followed for 5 years after birth, no significant benefit was found with prenatal fluoride compared with placebo.¹⁷ Furthermore, another study failed to find any significant increase in fluoride content of enamel in children who received prenatal fluoride compared to placebo.¹⁸ In 2001, the CDC indicated that there was a lack of evidence to support a recommendation for the use of prenatal fluoride.¹⁹

Dental Treatment Timing

Other than as part of a good plaque control program, elective dental care is best avoided during the first trimester because of potential vulnerability of fetuses (Table 17.1). The second trimester is the safest period during which to provide routine dental care. Emphasis should be placed

on controlling active disease and eliminating potential problems that could occur later in pregnancy or during the immediate postpartum period because providing dental care during these periods is often difficult. Extensive reconstruction or significant surgical procedures are best postponed until after delivery.

The early part of the third trimester is still a good time to provide routine dental care. However, after the middle of the third trimester, elective dental care is best postponed. This is because of the increasing feeling of discomfort that many expectant mothers may experience. Prolonged time in the dental chair should be avoided to prevent the complication of supine hypotension. If supine hypotension develops, rolling the patient onto her left side affords return of circulation to the heart. Scheduling short appointments, allowing the patient to assume a semireclined position, and encouraging frequent changes of position can help to minimize problems.

Dental Radiographs

Dental radiography is one of the more controversial areas in the management of pregnant patients. Pregnant patients who require radiographs often have anxiety about the adverse effects of x-rays to their baby. In some instances, their obstetrician or primary care physician may reinforce these fears. In almost all cases involving dental radiography, these fears are unfounded. The safety of dental radiography has been well established, provided features such as fast exposure techniques (e.g., high-speed film or digital imaging), filtration, collimation, lead aprons, and thyroid collars are used. Of all aids, the most important for pregnant patients are protective lead aprons and thyroid collars. In addition, the use of digital radiography markedly reduces radiation exposure, equal to or greater than that with the use of F-speed film.²⁰

Ionizing radiation should be avoided, if possible, during pregnancy, especially during the first trimester because developing fetuses are particularly susceptible to radiation damage.²¹ However, if dental treatment becomes necessary, radiographs may be required to accurately diagnose and treat the patient. The American Academy of Pediatrics (AAP) and the American College of Obstetricians and Gynecologists have published guidelines stating: "Diagnostic radiologic procedures should not be performed during pregnancy unless the information to be obtained from them is necessary for the care of the patient and cannot be obtained by other means."²²⁻²⁴ Therefore, the dentist should understand the risks of ionizing radiation and know how to proceed as safely as possible in the event that radiographs are needed.

The teratogenicity of ionizing radiation is dose dependent; therefore, it is necessary to understand the units of measurement.²⁰ The absorbed dose is a measure of the energy absorbed by any type of ionizing radiation per unit of mass of any type of matter. The traditional unit of the absorbed dose is the rad (radiation absorbed dose). In recent years, however, there has been a move

TABLE 17.1 Treatment Timing During Pregnancy

First Trimester	Second Trimester	Third Trimester
Plaque control	Plaque control	Plaque control
Oral hygiene instruction	Oral hygiene instruction	Oral hygiene instruction
Scaling, polishing, curettage	Scaling, polishing, curettage	Scaling, polishing, curettage
Avoid elective treatment; urgent care only	Routine dental care	Routine dental care

to use the metric-based International System (IS), and its unit of measurement for absorbed dose is the Gray (Gy): 1 Gy equals 100 rads. Thus, 1 cGy (centigray) equals 1 rad. An additional term, *sievert*, is used as a measure of equivalent dose to compare the biologic effects of different types of radiation on a tissue or organ. For diagnostic x-ray examinations, 1 sievert equals 1 Gy.

Increased risk of adverse outcomes has not been detected among animals with continuous low-dose exposure less

than 5 rad (5 cGy) throughout pregnancy. The National Council for Radiation Protection²⁵ concluded that exposures less than 5 rads (5 cGy) were not associated with increased risk of malformations. Available animal and human data support the conclusion that no increase in gross congenital anomalies or intrauterine growth retardation occurs as a result of exposures during pregnancy totaling less than 5 cGy (5 rad).^{26,27} Table 17.2 provides a comparison of ionizing radiation exposures expressed in cGy. It is obvious that exposures from typical dental

TABLE 17.2 Effective Dose From Radiographic Examinations and Equivalent Background Exposure

Examination	Effective Dose (μSv)	Equivalent Background Exposure (days)
INTRAORAL¹		
Rectangular collimation		
Posterior bitewings: PSP or F-speed film	5	0.6
Full-mouth: PSP or F-speed film	35	4
Full-mouth: CCD sensor (estimated)	17	2
Round collimation		
Full-mouth: D-speed film	388	46
Full-mouth: PSP or F-speed film	171	20
Full-mouth: CCD sensor (estimated)	85	10
EXTRAORAL		
Panoramic ¹⁻³	9-24	1-3
Cephalometric ^{1,2,4}	2-6	0.3-0.7
Cone-beam CT ^{5,6}		
Large field of view	68-1073	8-126
Medium field of view	45-860	5-101
Small field of view	19-652	2-77
Multislice CT		
Head: conventional protocol ⁶⁻⁹	860-1500	101-177
Head: low-dose protocol ^{6,8}	180-534	21-63
Abdomen ⁷	5300	624
Chest ⁷	5800	682
Plain films ¹⁰		
Skull	70	8
Chest	20	2
Barium enema	7200	847

1. Data from Ludlow JB, Davies-Ludlow LE, White SC: Patient risk related to common dental radiographic examinations: the impact of 2007 international commission on radiological protection recommendations regarding dose calculation, *J Am Dent Assoc* 139:1237-1243, 2008.

2. Data from Lecomber AR, Yoneyama Y, Lovelock DJ, et al: Comparison of patient dose from imaging protocols for dental implant planning using conventional radiography and computed tomography, *Dentomaxillofac Radiol* 30:255-259, 2001.

3. Data from Ludlow JB, Davies-Ludlow LE, Brooks SL: Dosimetry of two extraoral direct digital imaging devices: NewTom cone beam CT and Orthophos Plus DS panoramic unit, *Dentomaxillofac Radiol* 32:229-234, 2003.

4. Data from Gijbels F, Sanderink G, Wyatt J, et al: Radiation doses of indirect and direct digital cephalometric radiography, *Br Dent J* 197:149-152, 2004.

5. Data from Pauwels R, Beinsberger J, Collaert B, et al: Effective dose range for dental cone beam computed tomography scanners, *Eur J Radiol* 81:267-271, 2012.

6. Data from Ludlow JB, Ivanovic M: Comparative dosimetry of dental CBCT devices and 64-slice CT for oral and maxillofacial radiology, *Oral Surg Oral Med Oral Pathol Oral Radiol Endod* 106:106-114, 2008.

7. Data from Shrimpton PC, Hillier MC, Lewis MA, et al: National survey of doses from CT in the UK: 2003, *Br J Radiol* 79:968-980, 2006.

8. Data from Loubele M, Jacobs R, Maes F, et al: Radiation dose vs. image quality for low-dose CT protocols of the head for maxillofacial surgery and oral implant planning, *Radiat Prot Dosimetry* 117:211-216, 2005.

9. Data from Loubele M, Bogaerts R, Van Dijck E, et al: Comparison between effective radiation dose of CBCT and MSCT scanners for dentomaxillofacial applications, *Eur J Radiol* 71:461-468, 2009.

10. Data from European Commission: *Referral guidelines for imaging*, Radiation Protection 118, 2007. <http://www.sergas.es/Docs/Profesional/BoaPraticaClinica/RP118.pdf>

CCD, Charge-coupled device; CT, computed tomography; PSP, photostimulable phosphor.

Adapted from White SC, Pharoah MJ: *Oral radiology*, ed 7, St. Louis, 2014, Elsevier.

radiographs are less than natural daily background radiation. It should be noted, however, that maternal thyroid exposure to diagnostic radiation in excess of 0.4 mGy has been associated with a slight decrease in birth weight.²⁸ This finding reinforces the importance of using a thyroid collar on pregnant patients.

Teratogenicity is also dependent on the gestational age of the fetus at the time of exposure. During the organogenesis period (from the end of the 2nd to the 8th week postconception), fetuses are extremely sensitive to the teratogenic effect of ionizing radiation, particularly the central nervous system (CNS) between the 8th and 15th weeks of pregnancy.²⁹ From the 16th to the 25th week, there is a reduction in the radiosensitivity of the CNS and in many of the other organs. After the 25th week, the CNS becomes relatively radioresistant, and major fetal malformations and functional anomalies are highly improbable.

When risks of dental radiography are further assessed during pregnancy, three reports should be kept in mind. The first states that the maximum risk attributable to 1 cGy (which is more than 1000 full-mouth series with E-speed film and rectangular collimation or 10%–20% of the threshold dose) of in utero radiation exposure is estimated²⁵ to be approximately 0.1%. This is a quantity thousands of times less than the normal anticipated risks of spontaneous abortion, malformation, or genetic disease. The risk of a first-generation fetal defect from a dental radiographic examination is estimated to be 9 in 1 billion.^{28,29} The third report found that the gonadal dose to women, after full-mouth radiography using a lead apron, is less than 0.01 μ Sv, which is at least 1000-fold below the threshold shown to cause congenital damage to newborns.^{28,29} These figures indicate that with use of a lead apron, rectangular collimation, and E-speed film or faster techniques, one or two intraoral films are truly of minute significance in terms of radiation effects on a developing fetus. In terms that can be explained to a patient, one should consider the following: The gonadal or fetal dose of two periapical dental films (when a lead apron is used) is 700 times less than 1 day of average exposure to natural background radiation in the United States.^{30,31}

Despite the negligible risks of dental radiography, dentists should not be cavalier regarding its use during pregnancy (or at any other time, for that matter). Radiographs should be used selectively and only when necessary and appropriate to aid in diagnosis and treatment. Bitewing, panoramic, or selected periapical films are recommended for minimizing patient dose. To further reduce the radiation dose, the following measures should be used: rectangular collimation, E-speed or F-speed film or faster techniques (digital imaging reduces radiographic exposure by at least 50% compared with E-speed exposures), lead shielding (abdominal and thyroid collar), high kilovoltage (kV) or constant beams, and an ongoing quality assurance program.

An additional consideration is the pregnant dental auxiliary or dentist. The maximum permissible radiation dose for whole-body exposure of the pregnant dental care worker is 0.005 Gy or 5 mSv per year. This is equivalent to the maximum permissible radiation dose of the nonoccupationally exposed public and 10-fold less than the level of occupationally exposed nonpregnant workers (50 mSv).³² The National Council on Radiation Protection and Measurements reports that production of congenital defects is negligible from fetal exposures of 50 mSv.³² To further ensure safety, a pregnant operator should wear a film badge; stand more than 6 feet from the tube head; and position herself at between 90 and 130 degrees of the beam, preferably behind a protective wall (Fig. 17.1). When these guidelines are followed, no contraindication to pregnant women operating an x-ray machine occurs. However, dentists should familiarize themselves with federal (Code of Federal Regulations, Code 10, Part 20, Section 20.201) and state regulations that would supersede these guidelines.

Drug Administration

Another controversial area in the treatment of pregnant dental patients is drug administration. The principal concern is that a drug may cross the placenta and be toxic or teratogenic to the fetus. Additionally, any drug that is a respiratory depressant may cause maternal hypoxia, resulting in fetal hypoxia, injury, or death.³

Ideally, drug administration should be avoided during pregnancy, especially during the first trimester. However, adhering to this rule is sometimes impossible. Actually, 75% of pregnant women in the United States are taking some type of medication.³ Fortunately, most of the commonly used drugs in dental practice can be given during pregnancy with relative safety, although a few exceptions are notable. Table 17.3 presents a suggested approach to drug usage for pregnant patients.³⁻⁵

Before prescribing or administering a drug to a pregnant patient, the dentist should be familiar with the U.S. Food and Drug Administration (FDA) categorization of prescription drugs for pregnancy based on their potential risk of fetal injury.³² These pregnancy risk classification categories, although not without limitations, are meant to aid clinicians and patients in making decisions about drug therapy. Counseling should be provided to ensure that women who are pregnant clearly understand the nature and magnitude of the risk associated with a drug. In 2008, the FDA announced that it was eliminating the current pregnancy risk classification system due to inadequacies; however, at this time the original system is still in place.³²

The current five pregnancy labeling categories are as follows (Fig. 17.2):

- A Controlled studies in humans have failed to demonstrate a risk to the fetus, and the possibility of fetal harm appears remote.

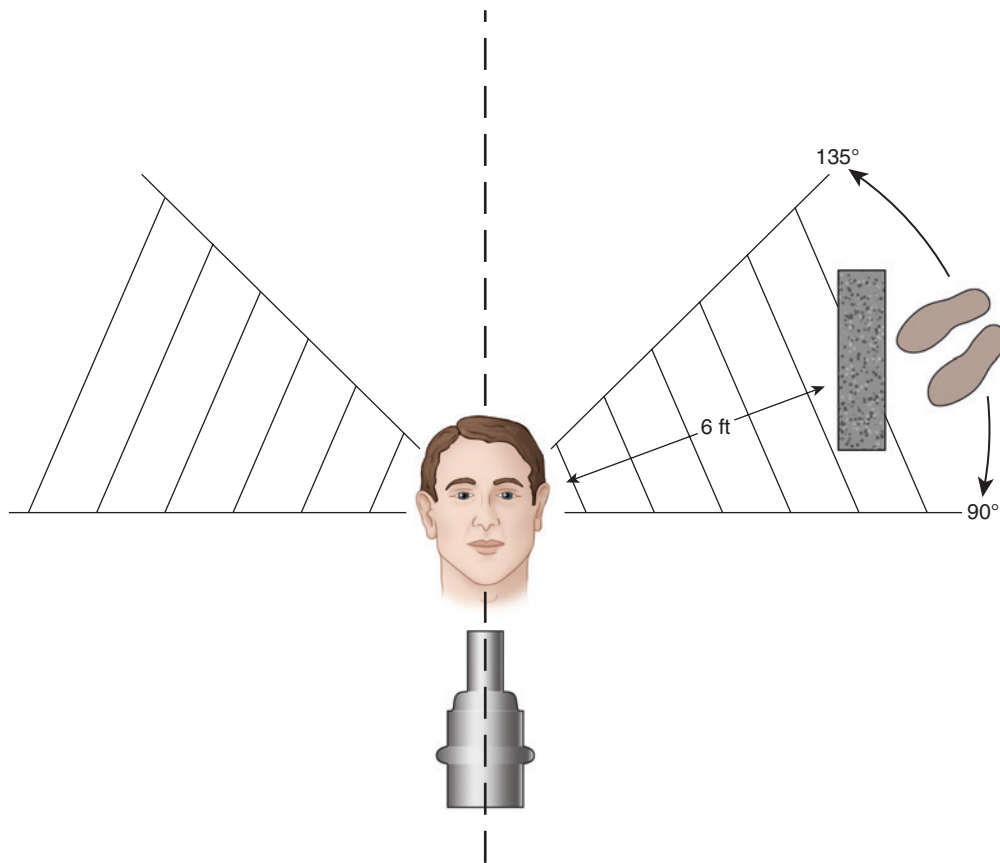

FIG 17.1 Proper operator position during exposure of x-rays.

- B Animal studies have not indicated fetal risk, and human studies have not been conducted; *or* animal studies have shown a risk, but controlled human studies have not.
- C Animal studies have shown a risk, but controlled human studies have not been conducted, or studies are not available in humans or animals.
- D Positive evidence of human fetal risk exists, but in certain situations, the drug may be used despite its risk.
- X Evidence of fetal abnormalities and fetal risk exists based on human experience, and the risk outweighs any possible benefit of use during pregnancy.^{3,32}

Drugs in categories A or B are preferable for prescribing during pregnancy. However, many commonly prescribed drugs used in dentistry fall into category C, and thus the safety of their use is often uncertain. Drugs in category C present the greatest difficulty for the dentist and the physician in terms of therapeutic and medicolegal decisions, and therefore, consultation with the physician may be needed^{3,32} (Fig. 17.2).

Physicians may advise against the use of some of the approved drugs or conversely may suggest the use of an uncertain or questionable drug. The FDA categories are general guidelines and may be incomplete, and therefore, differences in practice are not unusual. An example of

the occasional use of a questionable drug would be a category C narcotic analgesic for a pregnant patient who is in severe pain.

Local Anesthetics. Common local anesthetics (lidocaine, prilocaine) administered with epinephrine are generally considered safe for use during pregnancy.⁴ Articaine, bupivacaine, and mepivacaine are typically safe, although some caution should be exercised. Although both the local anesthetic and the vasoconstrictor cross the placenta, subtoxic threshold doses have not been shown to cause fetal abnormalities. Because of adverse effects associated with high levels of local anesthetics, it is important not to exceed the manufacturers recommended maximum dose.

Some topical anesthetics, including benzocaine, dyclonine, and tetracaine, may be acceptable but used with caution. There is no problem with topical lidocaine.^{3,4}

Analgesics. The analgesic of choice during pregnancy is acetaminophen. Aspirin and nonsteroidal antiinflammatory drugs convey risks for constriction of the ductus arteriosus, as well as for postpartum hemorrhage and delayed labor (see Table 17.3).^{3,34} The risk of these adverse events increases when agents are administered during the third trimester. Therefore, it is best to avoid these analgesics (especially in the third trimester) or use them with caution. Risk also is more closely associated with prolonged administration, high dosage, and selectively potent antiinflammatory drugs, such as glucocorticoids

and indomethacin. Most opioids, including codeine, Demerol, and propoxyphene, are associated with multiple congenital defects and should be used cautiously and only if needed.^{3,34} The safety of hydrocodone and oxycodone is unclear, but because there is no possibility of adverse respiratory effects, it is best to avoid them or use them with caution.^{3,33-37}

Antibiotics. Penicillins (including amoxicillin), erythromycin (except in estolate form), cephalosporins, metronidazole, and clindamycin are generally considered to be safe for expectant mothers and developing fetuses.³⁴

The use of tetracycline, including doxycycline, is contraindicated during pregnancy. Tetracyclines bind to hydroxyapatite, causing brown discoloration of teeth, hypoplastic enamel, inhibition of bone growth, and other skeletal abnormalities.^{3,34} Clarithromycin should be avoided or use with caution.^{3,34}

Antibiotics and Oral Contraceptives. The concern for potential interactions between antibiotics and oral contraceptives requires mention in this chapter. This concern arises from the ability of select antibiotics such as rifampin, an antituberculosis drug, to reduce plasma levels of

TABLE 17.3 Key Medication Considerations During Pregnancy and Breast-Feeding

Agent	FDA PR* Category	Safe During Pregnancy?	Safe During Breastfeeding?
Analgesics and Antiinflammatories[†]			
Acetaminophen	B	Yes	Yes
Aspirin	C/D	Avoid	Avoid
Codeine	C	Use with caution	Yes
Glucocorticoids (dexamethasone, prednisone)	C	Avoid [‡]	Yes
Hydrocodone	C	Use with caution	Use with caution
Ibuprofen [§]	C/D	Avoid use in third trimester	Yes
Oxycodone	B	Use with caution	Use with caution
Antibiotics^{¶#}			
Amoxicillin	B	Yes	Yes
Azithromycin	B	Yes	Yes
Cephalexin	B	Yes	Yes
Chlorhexidine (topical)	B	Yes	Yes
Clarithromycin	C	Use with caution	Use with caution
Clindamycin	B	Yes	Yes
Clotrimazole (topical)	B	Yes	Yes
Doxycycline	D	Avoid	Avoid
Erythromycin	B	Yes	Use with caution
Fluconazole	C/D	Yes (single-dose regimens)	Yes
Metronidazole	B	Yes	Avoid; may give breast milk an unpleasant taste
Nystatin	C	Yes	Yes
Penicillin	B	Yes	Yes
Terconazole (topical)	B	Yes	Yes
Tetracycline	D	Avoid	Avoid
Local Anesthetics			
Articaine	C	Use with caution	Use with caution
Bupivacaine	C	Use with caution	Yes
Lidocaine (with or without epinephrine)	B	Yes	Yes
Mepivacaine (with or without levonordefrin)	C	Use with caution	Yes
Prilocaine	B	Yes	Yes
Benzocaine (topical)	C	Use with caution	Use with caution
Dyclonine (topical)	C	Yes	Yes
Lidocaine (topical)	B	Yes	Yes
Tetracaine (topical)	C	Use with caution	Use with caution
Sedatives			
Benzodiazepines	D/X	Avoid	Avoid
Zaleplon	C	Use with caution	Use with caution
Zolpidem	C	Use with caution	Yes

Continued

TABLE 17.3 Key Medication Considerations During Pregnancy and Breast-Feeding—cont'd

Agent	FDA PR* Category	Safe During Pregnancy?	Safe During Breastfeeding?
Emergency Medications			
Albuterol	C	Steroid and β_2 -agonist inhalers are safe	Yes
Diphenhydramine	B	Yes	Avoid
Epinephrine	C	Use with caution	Yes
Flumazenil	C	Use with caution	Use with caution
Naloxone	C	Use with caution	Use with caution
Nitroglycerin	C	Use with caution	Use with caution

*FDA PR: U.S. Food and Drug Administration Pregnancy Risk. See Table 1 for FDA PR category definitions.

[†]In the case of combination products (such as oxycodone with acetaminophen), the safety with respect to either pregnancy or breastfeeding is dependent on the highest-risk moiety. In the example of oxycodone with acetaminophen, the combination of these two drugs should be used with caution, because the oxycodone moiety carries a higher risk than the acetaminophen moiety.

[‡]Oral steroids should not be withheld from patients with acute severe asthma.

[§]Ibuprofen is representative of all nonsteroidal antiinflammatory drugs. In breastfeeding patients, avoid cyclooxygenase selective inhibitors such as celecoxib, as few data regarding their safe use in this population are available, and avoid doses of aspirin higher than 100 milligrams because of risk of platelet dysfunction and Reye syndrome.

[¶]Antibiotic use during pregnancy: The patient should receive the full adult dose and for the usual length of treatment. Serious infections should be treated aggressively. Penicillins and cephalosporins are considered safe. Use higher-dose regimens (such as cephalexin 500 mg three times per day rather than 250 mg three times per day), as they are cleared from the system more quickly because of the increase in glomerular filtration rate in pregnancy.

[#]Antibiotic use during breastfeeding: These agents may cause altered bowel flora and, thus, diarrhea in the baby. If the infant develops a fever, the clinician should take into account maternal antibiotic treatment.

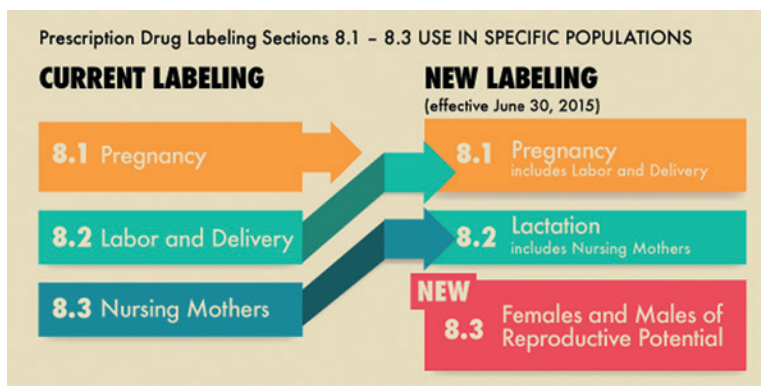

FIG 17.2 Food and Drug Administration Labeling for Drugs Used During Pregnancy and Breastfeeding (2015).

circulating oral contraceptives. It has been speculated that this interaction also may be seen with other antibiotics; however, studies to date regarding other antibiotics have been less convincing. To address this concern, the American Dental Association Council on Scientific Affairs³³ issued the following recommendations when prescribing antibiotics to a female patient who takes oral contraceptives: “The dentist should (1) advise the patient of the potential risk of the antibiotic’s reducing the effectiveness of the oral contraceptive, (2) recommend that the patient discuss with her physician the use of an additional nonhormonal means of contraception, [and] (3) advise the patient to maintain compliance with oral contraceptives when concurrently using antibiotics.” The application of these recommendations appears prudent until the findings of larger studies become available. In general, dentists should

provide treatment for acute infection irrespective of the stage of pregnancy.

Anxiolytics. Few anxiolytics are considered safe to use during pregnancy. Benzodiazepines, zaleplon, and zolpidem should be avoided. However, a single, short-term exposure to nitrous oxide–oxygen (N_2O-O_2) for less than 35 minutes is not thought to be associated with any human fetal anomalies, including low birth rate.^{36,37} In contrast, however, chronic occupational exposure to N_2O-O_2 has been associated with spontaneous abortion and reduced fertility in humans.³⁸ Nitrous oxide may cause inactivation of methionine synthetase and vitamin B_{12} , resulting in altered DNA metabolism that can lead to cellular abnormalities in animals and birth defects. Accordingly, the following guidelines are recommended if N_2O-O_2 is used during pregnancy:^{36,39}

- Use of N₂O–O₂ inhalation should be minimized to 30 minutes.
- At least 50% oxygen should be delivered to ensure adequate oxygenation at all times.
- Appropriate oxygenation should be provided to avoid diffusion hypoxia at the termination of administration.
- Repeated and prolonged exposures to nitrous oxide are to be prevented.
- The second and third trimester are safer periods for treatment because organogenesis occurs during the first trimester.

An additional consideration involves female dentists or dental auxiliaries who are pregnant. These individuals should not be exposed to persistent trace levels of nitrous oxide in the operatory. The use of appropriate scavenging equipment can help alleviate this problem. Female dental health care workers who are chronically exposed to nitrous oxide for more than 3 hours per week, when scavenging equipment is not used, have decreased fertility and increased rates of spontaneous abortion.³⁹ Implementation of National Institute for Occupational Safety and Health recommendations can reduce occupational exposure to nitrous oxide (Box 17.2).^{39,40}

Nursing. A potential problem arises when a nursing mother requires the administration of a drug in the course of dental treatment. The concern is that the administered drug may enter the breast milk and be transferred to the nursing infant, in whom exposure may result in adverse effects.

BOX 17.2 Control of Nitrous Oxide in the Dental Office During Pregnancy

1. Inspect nitrous oxide equipment and replace defective tubing and parts.
2. Check pressure connections for leaks; fix leaks.
3. Ensure that mask fits well and is secure. Check that the reservoir bag is not over- or underinflated.
4. Provide operatory ventilation of 10 or more room air exchanges per hour.
5. Use a scavenging system and appropriate mask sizes. Vacuum should provide up to 45 L/min.
6. Connect and turn on the vacuum pump of the scavenging system before providing nitrous oxide.
7. Regularly conduct air sampling. Maintain low exposure limits (e.g., 25 ppm*) when pregnant dental health care workers are involved.

*This limit is a National Institute for Occupational Safety and Health recommendation. In contrast, Yagiela⁶⁵ suggests a time-weighted average lower limit of 100 ppm for an 8-hour workday. Modified from McGlothlin JD, Crouch KG, Mickelsen RL: *Control of nitrous oxide in dental operatories*. Cincinnati, OH, 1994, U.S. Department of Health and Human Services, Public Health Service, Centers for Disease Control and Prevention, National Institute for Occupational Safety and Health, Division of Physical Sciences and Engineering, Engineering Control Technology Branch. DHHS publication no. (NIOSH) 94-129. ETTB report no. 166-04.

Data on which to draw definitive conclusions about drug dosages and effects via breast milk are limited. However, retrospective clinical studies and empiric observations, coupled with known pharmacologic pathways, allow recommendations to be made. The AAP concludes that “most drugs likely to be prescribed to the nursing mother should have no effect on milk supply or on infant well-being.”⁴¹ A significant fact is that the amount of drug excreted in the breast milk usually is not more than about 1% to 2% of the maternal dose. Therefore, most drugs are of little pharmacologic significance to infants.

Agreement exists that a few drugs, or categories of drugs, are definitely contraindicated for nursing mothers. These include lithium, anticancer drugs, radioactive pharmaceuticals, and phenindione.^{3,41} Table 17.3 contains recommendations adapted from the AAP regarding the administration of commonly used dental drugs during breastfeeding. As with drug use during pregnancy, individual physicians may wish to modify these recommendations, which should be viewed only as general guidelines for treatment.

In addition to careful drug selection, nursing mothers may take the drug just after breastfeeding and avoid nursing for 4 hours or longer if possible. This should result in reduced drug concentrations in the breast milk.

Treatment Planning Modifications

No technical modifications are required for pregnant patients. However, full-mouth radiographs, reconstruction, crown and bridge procedures, and significant surgery are best delayed until after pregnancy. A prominent gag reflex also may dictate a delay in certain dental procedures. Many patients have a concern about mercury exposure from amalgam fillings. In 2009,⁴² the FDA concluded that “although data are limited, existing data do not suggest that fetuses are at risk for adverse health effects due to maternal exposure to mercury vapors from dental amalgam.” The FDA does note, however, that “maternal exposures are likely to increase temporarily when new dental amalgams are inserted or existing dental amalgams are removed.” The FDA furthermore concluded that “existing data support a finding that infants are not at risk for adverse health effects from the breast milk of women exposed to mercury vapors from dental amalgams.” Practitioners should be aware, however, that several European countries and Canada have national recommendations advising dentists to limit or avoid the placement and replacement of amalgams during pregnancy.

As for the risk to dental personnel from exposure to dental amalgam, the FDA concludes that “existing data indicate that dental professionals are generally not at risk for mercury toxicity except when dental amalgams are improperly used, stored, triturated, or handled.”

Oral Complications and Manifestations

The most common oral complication of pregnancy is pregnancy gingivitis (Fig. 17.3). However, the incidence



FIG 17.3 Generalized gingivitis (“pregnancy gingivitis”) in a woman in the sixth month of pregnancy.



FIG 17.4 Pyogenic granuloma (“pregnancy tumor”) occurring during pregnancy.

of dental caries increases as well. This condition results from an exaggerated inflammatory response to local irritants and less than meticulous oral hygiene during periods of increased secretion of estrogen and progesterone and altered fibrinolysis.¹⁰ Pregnancy gingivitis begins at the marginal and interdental gingiva, usually in the second month of pregnancy. Progression of this condition leads to fiery red and edematous interproximal papillae that are tender to palpation. In approximately 1% of gravid women, the hyperplastic response may exacerbate in a localized area, resulting in a pyogenic granuloma or “pregnancy tumor” (Fig. 17.4). The most common location for a pyogenic granuloma is the labial aspect of the interdental papilla. The lesion is generally asymptomatic; however, tooth brushing may traumatize the lesion and cause bleeding. Hyperplastic gingival changes become apparent around the second month and continue until after parturition, at which time the gingival tissues usually

regress and return to normal, provided proper oral hygiene measures are implemented and any calculus present is removed.¹⁰ Surgical or laser excision is occasionally required if symptoms, bleeding, or interference with mastication dictates. Pregnancy does not cause periodontal disease but may modify and worsen what is already present.

A relationship between dental caries and the physiologic processes of pregnancy has not been demonstrated. Caries activity is attributed to the presence of cariogenic bacteria in the mouth, a diet containing fermentable carbohydrates, and poor oral hygiene. Control of the carious process through fluoride and chlorhexidine is important because maternal saliva is the primary vehicle for transfer of cariogenic streptococci to the infant.⁴³

Many women are convinced that pregnancy causes tooth loss (i.e., “a tooth for every pregnancy”) or that calcium is withdrawn from the maternal dentition to supply fetal requirements (i.e., “soft teeth”). Calcium is present in the teeth in a stable crystalline form and hence is not available to the systemic circulation to supply a calcium demand. However, calcium is readily mobilized from bone to supply these demands. Therefore, although calcium supplementation for the purpose of preventing tooth loss or soft teeth is unwarranted, the physician may prescribe calcium to fulfill the general nutritional requirements of the mother and infant.

Tooth mobility, localized or generalized, is an uncommon finding during pregnancy. Mobility is a sign of gingival disease, disturbance of the attachment apparatus, and mineral changes in the lamina dura. Because vitamin deficiencies may contribute to this and other congenital problems (e.g., folate deficiency: spina bifida), the dentist, when discussing oral hygiene, should take this opportunity to educate the patient about the benefits of the use of multivitamins. Daily removal of local irritants, adequate levels of vitamin C, and delivery of the newborn should result in reversal of tooth mobility.

Pregnant women often have a hypersensitive gag reflex. This, in combination with morning sickness, may contribute to episodes of regurgitation and lead to halitosis and enamel erosion. The dentist should advise the patient to rinse after regurgitation with a solution that neutralizes the acid (e.g., baking soda, water).

OSTEOPOROSIS

Osteoporosis is defined as a skeletal disorder that compromises bone strength, predisposing a person to an increased risk of bone fracture due to inhibited calcium intake and mineral loss. According to World Health Organization criteria, osteoporosis occurs when the bone mineral density (BMD) is measured to be 2.5 standard deviations (SDs) less than the average value for young healthy women (a T-score of <2.5 SD).⁴⁴ Osteoporosis can be characterized as either primary or secondary. Primary osteoporosis occurs in both genders at all ages

but typically follows menopause in women and occurs later in life in men. Secondary osteoporosis is the result of medications (glucocorticoids), other conditions (hypogonadism), or diseases (celiac disease, cystic fibrosis).⁴⁵

EPIDEMIOLOGY

The National Osteoporosis Foundation estimates that more than 10 million people older than 50 years of age have osteoporosis, and another 34 million are at risk for the disease. Bone fractures among older adults reduce mobility and potentially increase the need for long-term care. Hip fractures are particularly problematic; one in three older adults who lived independently before a hip fracture remained in a nursing home for at least 1 year after his or her injury.⁴⁴

PATHOPHYSIOLOGY AND COMPLICATIONS

Osteoporosis is caused by an uncoupling of bone resorption from bone formation such that the activities of osteoclasts far outweigh those of the osteoblasts. Peak bone mass is achieved in early adulthood and, after this point, both women and men lose bone with increasing age. However, this process is accelerated in postmenopausal women whereby the loss of estrogen is associated with an increase in osteoclast activity. Decades of research indicate that estrogen plays a dominant multifactorial role in maintaining cortical bone formation by supporting osteoblasts and preventing bone resorption by suppressing osteoclast formation and stimulating osteoclast apoptosis.⁴⁵⁻⁴⁷

Fig. 17.5 illustrates normal bone remodeling through a balanced regulation of osteoblastic and osteoclastic

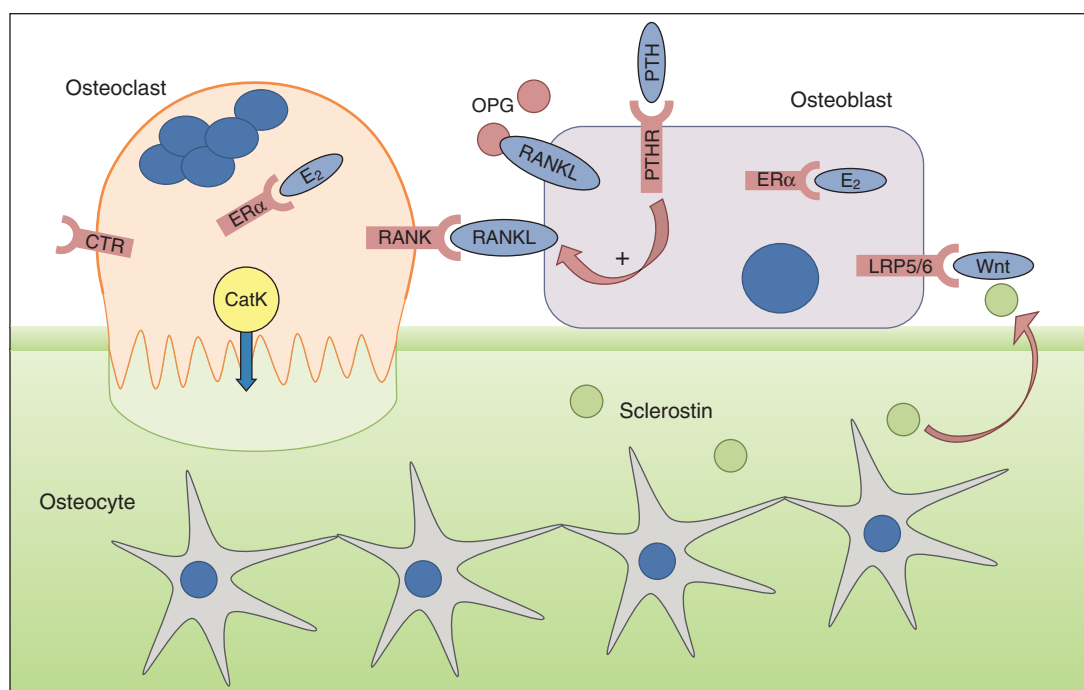

FIG 17.5 The cells responsible for bone remodeling, highlighting key signaling pathways that are targets for therapies recommended for the prevention of osteoporotic fracture. Osteocytes are embedded within mineralized bone and, in response to mechanical loading or microdamage, provide signals to osteoclasts to resorb. Osteoclast differentiation and function are dependent on the RANKL–RANK (receptor activator of nuclear factor-κB ligand–receptor activator of nuclear factor-κB) signaling pathway, which is negatively regulated by osteoprotegerin (OPG) *in vivo*. Circulating parathyroid hormone (PTH) is a physiologic regulator of plasma calcium and binds to parathyroid hormone receptor (PTHr) on osteoblasts indirectly stimulating osteoclast activity via upregulation of RANKL and downregulation of OPG expression. Calcitonin binds to the calcitonin receptor (CTR) expressed on mature osteoclasts to reversibly inhibit osteoclast function, although the exact physiologic relevance for calcitonin is not fully understood. Estrogen (E₂) has a positive effect on bone through effects on osteoblasts and osteoclasts via estrogen receptor (ERα). Cathepsin K (CatK) is secreted by resorbing osteoclasts across the convoluted ruffled border membrane and is required to degrade collagen. Osteoclast activity releases factors from the bone, which attract osteoblasts to the site of resorption. Osteoblast differentiation and function are controlled by the Wnt signaling pathway via the lipoprotein-related protein 5/6 (LRP5/6) and Frizzled co-receptors, which is regulated by endogenous inhibitors such as sclerostin, expressed by osteocytes and upregulated in response to unloading.

activity. Osteoporosis occurs when this balance shifts to increased osteoclastic activity. The integrity of the skeleton is also intricately linked to appetite and energy balance, and the underlying mechanism by which bone mass is regulated by the brain is through a leptin-mediated brain-derived serotonin pathway.⁴⁵⁻⁴⁷ In addition, glucocorticoid-induced osteoporosis is one of the most common and serious adverse effects associated with glucocorticoid use, which significantly increase risk of fractures with long-term use.⁴⁸

LABORATORY AND DIAGNOSTIC TESTING

Serum biomarkers may be helpful in the diagnosis of osteoporosis. Table 17.4 outlines some of the diagnostic serum markers. Serum alkaline phosphate levels are indicators of osteoblastic activity, and tartrate resistant acid phosphatase (TRAP), C-terminal telopeptide of collagen type I (CTP), and beta-crosslaps (beta-CTX) are indicators of increased osteoclastic activity.

Conventional radiography is used for the diagnosis of osteoporosis, but approximately 75% of cases are not diagnosed until late in the disease process because imaging is not a routine part of primary medical care.⁴⁵⁻⁴⁷ Recently, a new method for point-of-care osteoporosis screening and diagnostics has emerged that is effective for early diagnosis of osteoporosis.^{49,50} The results of these studies suggest applicability of ultrasound method for osteoporosis diagnostics at primary health care. This method provides an estimate of BMD (i.e., density index [DI]). Areal BMD measurements at the femoral neck (BMD_{neck}) and total hip (BMD_{total}) are determined by using axial dual-energy x-ray absorptiometry (DXA) for women older than 50 years of age. Osteoporosis was diagnosed in individuals with a T-score of -2.5 or less in the total hip or femoral neck ($n = 75$). By using the ISCD approach for the DI, only 28.7% of the participants were found to require an additional DXA measurement. The results demonstrate a significant improvement in the current state osteoporosis.^{49,50}

TABLE 17.4 Serum Biomarkers for Osteoporosis

Osteoblastic Activity Markers	Osteoclastic Activity Markers
Total or bone-specific alkaline phosphatase	Tartrate resistant acid phosphatase (TRAP)
Osteocalcin	C-terminal telopeptide of collagen type I (ICTP)
N- or C-terminal propeptide of procollagen type I	β -CrossLaps (β -CTX)
	N-terminal telopeptide of collagen type I (NTX)

Adapted from Torres E, Mezquita P, DeLa Higuera M, Fernandez D, Munoz M: Actualizacion sobre la determinacion de marcadores de remodelado oseo, *Endocrinol Nutr* 50(6):237-243, 2003.

MEDICAL MANAGEMENT

In men, testosterone plays a crucial role in protecting the skeleton. Experiments with androgen receptor knockout mouse models showed that the absence of androgen receptors on the surface of bone cells leads to the development of osteoporosis in male mice but not in female mice.^{46,47} These experiments showed that the protective action of testosterone is mediated via the supportive activity of osteoblasts on osteoclasts, not directly on osteoclasts themselves. Although testosterone has a direct effect on bone, estrogen is also important in maintaining bone health in men because estrogen activity in bone cells is via the conversion of androgen to estrogen, indicating a dual protective action of androgens in men.^{46,47}

Bisphosphonates are the primary drugs used to treat osteoporosis by suppressing osteoclast activity and increasing BMD (Fig. 17.6). Intravenous (IV) bisphosphonates are used in the treatment of certain malignancies, skeletal-related events associated with bone metastases, and multiple myeloma. Oral bisphosphonates are used to treat osteoporosis and osteopenia (decrease of calcification and bone density). Box 17.3 and Table 17.5 list some of the IV and orally administered bisphosphonate agents and their associated effects.

Secondary osteoporosis is defined as osteoporosis that develops as a consequence of an unrelated underlying cause such as drug treatment (e.g., chronic corticosteroid use), hypogonadism, malnutrition or eating disorders such as anorexia nervosa, excessive exercise, and neoplastic disorders.⁴⁶⁻⁵³ Because these comorbid conditions increase the risk of fractures among patients with osteoporosis, these patients may require more aggressive treatment with bisphosphonate drugs (i.e., teriparatide, risedronate, and etidronate) to decrease their risk of vertebral fracture.⁴⁸

Box 17.3 provides general indications for the treatment of osteoporosis.

ORAL HEALTH IMPLICATIONS OF OSTEOPOROSIS

Studies have shown that mandibular and maxillary bone densities, as well as alveolar BMD and height, are modestly correlated with other skeletal sites.⁵⁴ However, it does not appear that low BMD in the jaw results in other adverse periodontal changes, such as, gingival bleeding, greater probing depth, and gingival recession.^{55,56}

Smoking tobacco, radiation therapy, and diabetes have been shown to be associated with the progression of osteoporosis and subsequent risk factors for dental implant failure.⁵⁷ Dentists should be aware of the implications and possible risks when patients are medicated with bisphosphonate agents (as well as other drugs) that might place them at risk for osteonecrosis of the jaw (ONJ).

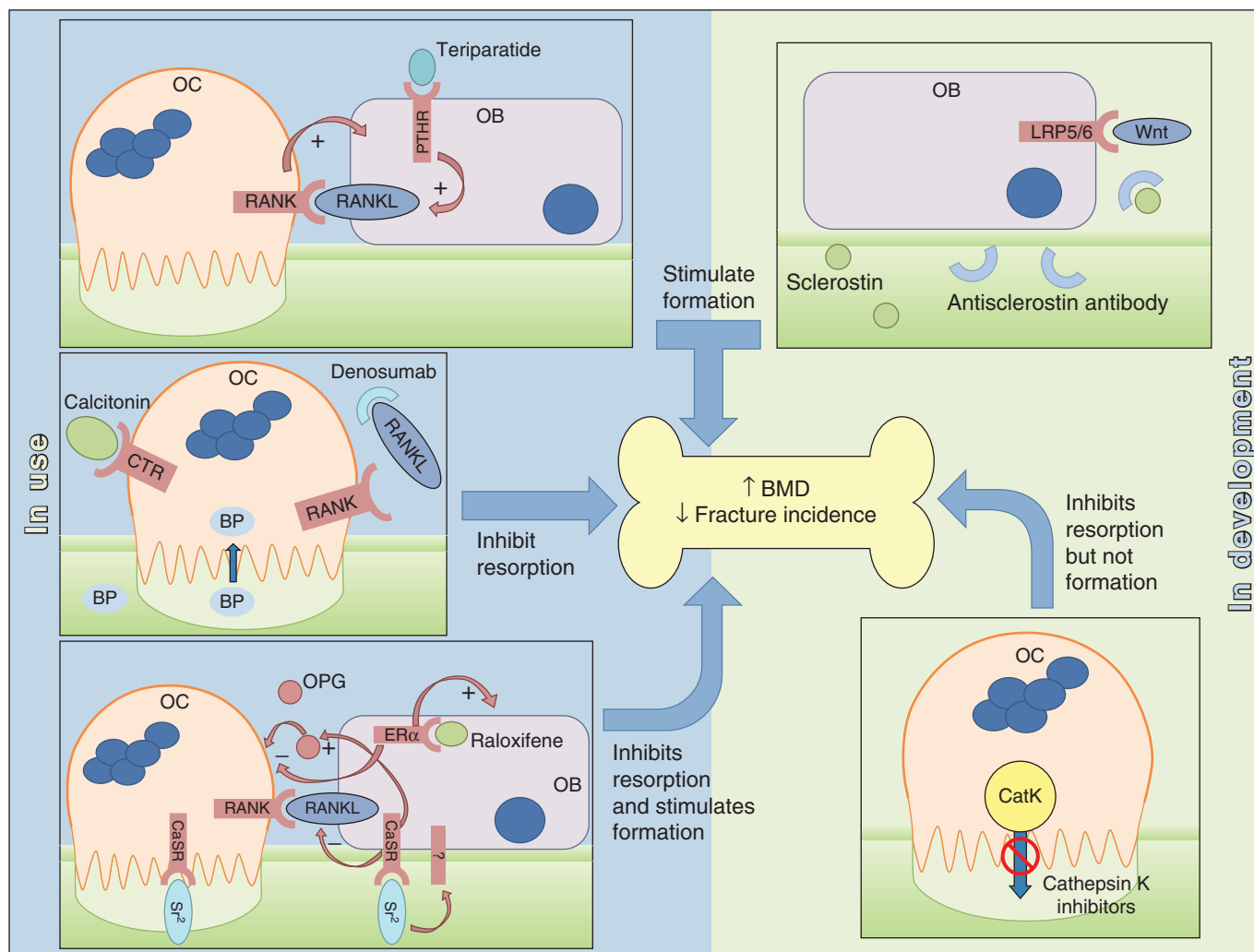
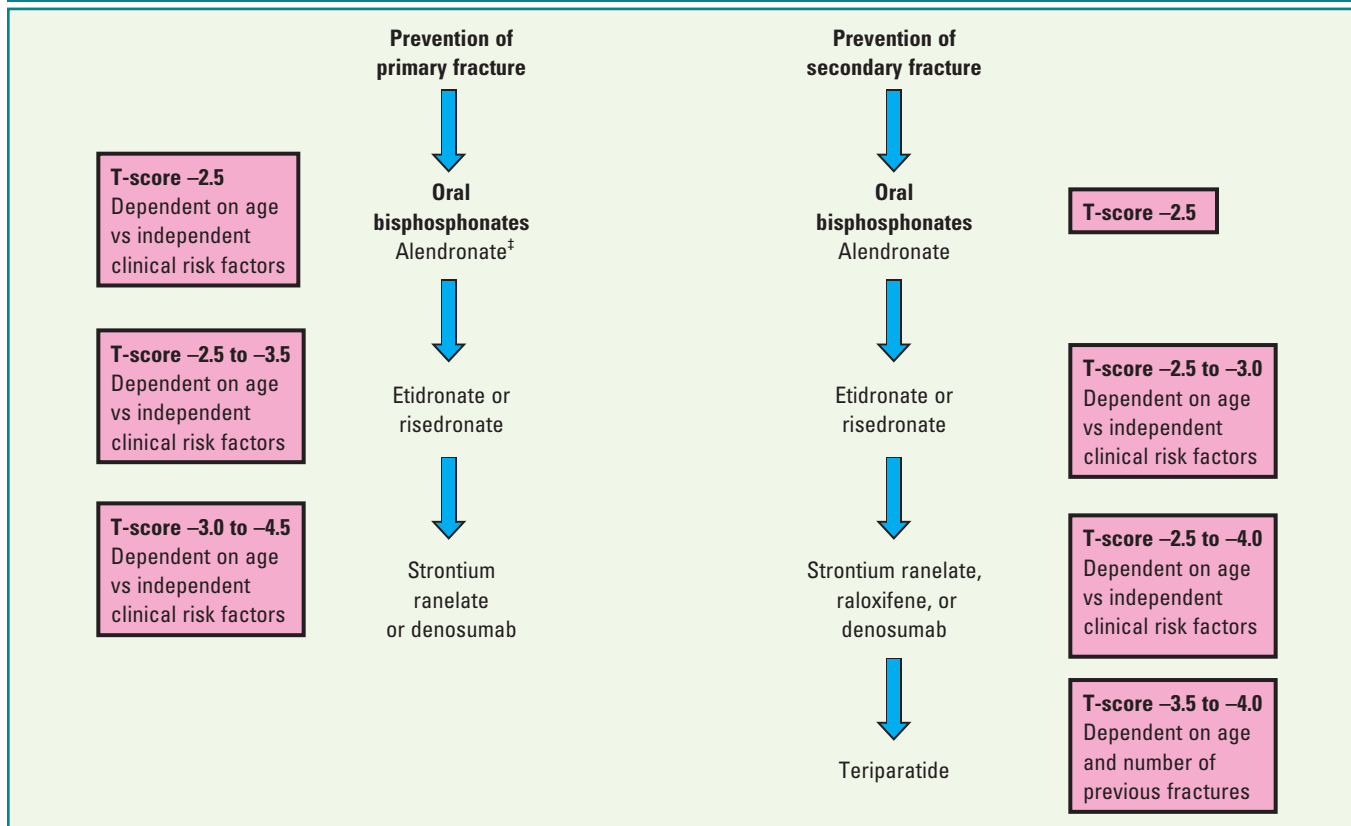

FIG 17.6 Sites of action of different classes of drugs that are either in clinical use (*left*) or in development (*right*). *Drugs that inhibit resorption:* Bisphosphonate (BPs) are internalized and inactivate resorbing osteoclasts, and calcitonin binds to a cell-surface receptor to inhibit osteoclast (OC) function. Denosumab prevents receptor activator of nuclear factor- κ B ligand (RANKL) interacting with receptor activator of nuclear factor- κ B (RANK), therefore potentially inhibiting both the differentiation of OCs and the function of mature OCs. *Drugs that stimulate formation:* Teriparatide, an analogue of parathyroid hormone (PTH), binds to the parathyroid hormone receptor (PTHr) on osteoblasts (OBs), and after a transient increase in OC activity, a coupled increase in OB activity is observed. Antisclerostin antibodies prevent sclerostin binding to the lipoprotein-related protein 5/6 (LRP5/6) co-receptor, thereby allowing Wnt ligands to activate the canonical signaling pathway in OBs. *Drugs that uncouple bone formation from resorption:* Raloxifene interacts with intracellular estrogen receptor ($ER\alpha$) in OBs and, via upregulation of osteoprotegerin (OPG) and downregulation of RANKL, inhibits OCs. Raloxifene also has positive effects on OB proliferation. Strontium ranelate (Sr_2) substitutes for Ca_2 in the bone and interacts with the calcium-sensing receptor (CaSR) on OBs, upregulating OPG expression and downregulating RANKL expression to indirectly inhibit OCs while acting directly on the CaSR on OCs themselves to induce apoptosis. The anabolic effect of strontium ranelate on OBs is also mediated via the CaSR as well as potentially other, unidentified receptors. Cathepsin K inhibitors uncouple resorption from formation because the cross-talk between inactive OCs and OBs is maintained. *BMD*, Bone mineral density; *CatK*, cathepsin K; *CTR*, calcitonin receptor.

BOX 17.3 A Summary of the National Institute for Clinical Excellence (NICE) Guidelines for the Therapeutic Management of Primary and Secondary Osteoporotic Fractures in Postmenopausal Women



*Available at <https://pathways.nice.org.uk/pathways/osteoporosis>.

†Alendronate is the treatment of choice in each case, but for those intolerant or contraindicated for alendronate, a hierarchy of treatment choices is recommended, and patients are assigned to each treatment based on T-score, the magnitude of which depends on age and the number of independent clinical risk factors.

TABLE 17.5 Examples of Bisphosphonate Agents With Relative Potency

Bisphosphonate Agent	Potency	Route
Didronel	1	PO
Bonifos	10×	PO or IV
Clasteon (Canada)		
Skelid	10×	PO
Aredia*	100×	IV
	100×	PO
	1000×	IV
Fosamax*	1000×	Oral
Boniva*	5000×	PO or IV
Actonel*	5000×	PO
Reclast*	10,000×	IV once per year
Zometa*		IV q3–4 wk

*These agents have been shown to be associated with osteonecrosis. IV, Intravenous; PO, oral; q, every.

OSTEONECROSIS

In the past decade, a potentially serious oral complication of cancer treatment was identified: osteonecrosis. Originally, this condition when associated with bisphosphonate drug use was referred to as bisphosphonate-associated osteonecrosis (BON)⁵⁵⁻⁵⁷ (Fig. 17.7). However, more recently, other associated drugs and comorbidities have been identified.^{58,59} Therefore, it is not appropriate to refer to this condition as only bisphosphonate related.

Bisphosphonates are synthetic analogues of inorganic pyrophosphate that have a high affinity for calcium. Bisphosphonates also are potent inhibitors of osteoclastic activity. All bisphosphonate compounds accumulate over extended periods of time in mineralized bone matrix. Depending on the duration of the treatment and the specific bisphosphonate prescribed, the drug may remain in the body for years.^{46,47}

Bisphosphonates are used to treat osteoporosis, Paget disease of bone, multiple myeloma (which is discussed in Chapter 23), and hypercalcemia of malignancy.^{44,47} In



FIG 17.7 **A**, Extraoral and **B**, Intraoral views of bisphosphonate-associated osteonecrosis of the mandible in a patient with metastatic breast cancer. (Courtesy of Dr. Denis Lynch, Milwaukee, WI.)

patients with osteoporosis, it is expected that bisphosphonates will arrest bone loss and increase bone density, decreasing the risk of pathologic fracture resulting from progressive bone loss. Bisphosphonates are given to patients with cancer to help control bone loss resulting from metastatic skeletal lesions. Use of these agents has been shown to reduce skeletal-related events associated with multiple myeloma (e.g., fractures) and metastatic solid tumors (e.g., breast, lung, and prostate cancers) in the bones. The physician's decision regarding which type of bisphosphonate to use depends on the type of medical condition being treated and the potency of the drug required.^{46,47} For example, whereas orally administered bisphosphonates often are used in patients with osteoporosis, the injectable bisphosphonates are used in patients

with cancer who develop primary lesions of bone or skeletal metastasis.^{46,47}

Patients treated with bisphosphonates (as well as other antiosteoporotic drugs) have a risk of developing ONJ⁵⁵⁻⁶¹ (see Fig. 17.7). Several medications have been associated with the onset of ONJ; therefore, the current description of this condition is termed medication-related osteonecrosis of the jaw (MRONJ). The recognition of jaw necrosis as a complication of other drugs, including the RANK (receptor activator of nuclear factor- κ B) ligand inhibitor denosumab and some antiangiogenic agents prompted a special committee of the American Association of Oral and Maxillofacial Surgeons (AAOMS) to recommend the term *medication-related osteonecrosis of the jaw*.^{62,63}

Osteonecrosis of the jaw can occur with the oral administration of bisphosphonates but is rare (<0.01%). In contrast, ONJ is a much more common complication of injected bisphosphonates (2%–4%).⁵⁸⁻⁶⁴ The exact mechanism that leads to the induction of ONJ is unknown. However, risk factors have been recognized and may be classified as systemic and local. These include previous use of intravenous bisphosphonates (i.e., etidronate [Didronel], pamidronate [Aredia], zoledronic acid [Zometa]), diabetes mellitus, overall cancer stage and tumor burden, overall systemic and immune health, immunosuppressive drug use, any periodontal or other oral infection, and history of radiation to the jaws. Also, posterior sites are at higher risk than anterior sites, and the mandible is more often affected than the maxilla.⁵⁸⁻⁶⁴

Patients treated with IV bisphosphonates have a higher risk of developing ONJ. This risk increases when the duration of the therapy exceeds 2 years.⁵⁸⁻⁶⁴

Bone remodeling is a physiologic function that occurs in normal bone. During bone remodeling, the drug is taken up by osteoclasts and internalized in the cell cytoplasm, where it inhibits osteoclastic function and induces apoptotic cell death. It also inhibits osteoblast-mediated osteoclastic resorption and has antiangiogenic properties (see Fig. 17.5). As a result, bone turnover becomes profoundly suppressed, and over time, the bone shows little physiologic remodeling. The bone becomes brittle and unable to repair physiologic microfractures that occur in the human skeleton with daily activity (e.g., common masticatory forces). In the oral cavity, the maxilla and mandible are subjected to constant stress from masticatory forces.

Physiologic microdamage and microfractures occur daily in the oral cavity. Although the exact cause of ONJ is not known, it is theorized that in a patient taking a bisphosphonate, the resulting microdamage is not repaired, setting the stage for oral osteonecrosis to occur. Therefore, ONJ results from a complex interplay of bone metabolism, local trauma, increased demand for bone repair, infection, and hypovascularity.⁵⁸⁻⁶⁴

In the early stages of oral ONJ, radiographic manifestations may not be seen, or thickening of the lamina dura and a density in the medullary bone may be seen. Patients

usually are asymptomatic but may develop pain because of the necrotic bone becoming infected secondarily after it is exposed to the oral environment. The osteonecrosis often is progressive, potentially leading to extensive areas of bony exposure and dehiscence. When tissues are acutely infected, patients may complain of severe pain or lack of sensory sensation (paresthesia). Either symptom may be an indication of inflammation, necrosis, and peripheral nerve compression (see Fig. 17.7).⁵⁸⁻⁶⁴

In patients in whom ONJ develops spontaneously, the most common initial complaint is the sudden presence of intraoral discomfort and the presence of roughness that may progress to traumatize the oral soft tissues surrounding the area of necrotic bone. Therefore, the diagnosis of ONJ is based on the medical and dental history of each patient, as well as the observation of clinical signs and symptoms of this pathologic process.⁵⁸⁻⁶⁴ According to the most recent (2014) recommendations from the AAOMS,⁶³ the working definition of ONJ (or MRONJ) is based on the following criteria:

1. Current or previous treatment with a bisphosphonate (or other drug known to be associated with a higher risk of ONJ)
2. Exposed bone in the maxillofacial region that has persisted for more than 8 weeks
3. No history of radiation therapy to the jaws

The AAOMS staging⁶³ (four stages) for ONJ (MRONJ) is summarized in Table 17.6.

In the early stage (stage 0) of ONJ, no clinical or radiographic manifestations are evident. Patients usually are asymptomatic but may complain of nonspecific pain. Exposed bone becomes apparent in stage 1, when the patient is asymptomatic but may develop severe pain secondary to development of infection of the necrotic bone after exposure to the oral environment. In stage 2, the osteonecrosis often progresses, as evidenced by pain and erythema. Stage 3 is characterized by extension of exposed and necrotic bone beyond the region of alveolar bone, resulting in pathologic fracture, extraoral fistula formation, and establishment of oral antral–oral nasal communication. Patients with stage 2 or 3 ONJ may complain of severe pain and lack of sensory sensation (paresthesia). As noted previously, such changes may be an indication of peripheral nerve compression (see Fig. 17.7).⁶³

TREATMENT STRATEGIES

Treatment strategies seek to yield resolution and healing of ONJ. However, to date effective strategies have been elusive.⁵⁸⁻⁶⁴ In fact, many cases have poor outcomes despite therapy, progressing to extensive dehiscence and exposure of bone. Recommended strategies included local surgical debridement, bone curettage, local irrigation with antibiotics, and hyperbaric oxygen therapy. Unfortunately, their limited success rate compromises the oncologic, nutritional, and oral management of affected patients. Prevention

TABLE 17.6 Staging and Treatment Strategies

Staging of Medication-Related Osteonecrosis of the Jaw*	Treatment Strategies [†]
At risk: No apparent necrotic bone in patients who have been treated with oral or intravenous bisphosphonates	No treatment indicated Patient education
Stage 0: No clinical evidence of necrotic bone but nonspecific clinical findings, radiographic changes, and symptoms	Systemic management, including use of pain medication and antibiotics
Stage 1: Exposed and necrotic bone or fistulas that probe to bone in patients who are asymptomatic and have no evidence of infection	Antibacterial mouth rinse Clinical follow-up on a quarterly basis Patient education and review of indications for continued bisphosphonate therapy
Stage 2: Exposed and necrotic bone or fistulas that probe to bone associated with infection as evidenced by pain and erythema in the region of exposed bone with or without purulent drainage	Symptomatic treatment with oral antibiotics Oral antibacterial mouth rinse Pain control Debridement to relieve soft tissue irritation and infection control
Stage 3: Exposed and necrotic bone or a fistula that probes to bone in patients with pain, infection, and one or more of the following: exposed and necrotic bone extending beyond the region of alveolar bone (i.e., inferior border and ramus in mandible, maxillary sinus, and zygoma in maxilla) resulting in pathologic fracture, extraoral fistula, oral antral or oral nasal communication, or osteolysis extending to inferior border of the mandible or sinus floor	Antibacterial mouth rinse Antibiotic therapy and pain control Surgical debridement or resection for longer-term palliation of infection and pain

*Exposed or probable bone in the maxillofacial region without resolution for longer than 8 weeks in patients treated with an antiresorptive or an antiangiogenic agent who have not received radiation therapy to the jaws.

[†]Regardless of disease stage, mobile segments of bony sequestrum should be removed without exposing uninvolved bone. Extraction of symptomatic teeth within exposed necrotic bone should be considered because it is unlikely that extraction will exacerbate the established necrotic process.

Adapted from Ruggiero SL, Dodson TB, Fantasia J, et al; American Association of Oral and Maxillofacial Surgeons: American Association of Oral and Maxillofacial Surgeons position paper on medication-related osteonecrosis of the jaw—2014 update, *J Oral Maxillofac Surg* 72(10):1938-1956, 2014.

BOX 17.4 Dental Treatment Recommendations for Patients Treated With Bisphosphonates

- Treat active oral infections.
- Eliminate sites at high risk for infection. Remove nonrestorable teeth and teeth with substantial periodontal bone loss. Encourage routine dental care, oral examinations, and cleanings. Minimize periodontal inflammation, restorative treatment of caries, and endodontic therapy when indicated.
- Seek alternatives to surgical oral procedures with appropriate local and systemic antibiotics.
- Conduct extractions and other surgery using as little bone manipulation as possible, appropriate local and systemic antibiotics, and close follow-up to monitor healing.
- Consider additional imaging studies such as computed tomography scans.
- Remove necrotic bone as necessary with minimal trauma to adjacent tissue.
- Prescribe oral rinses, such as chlorhexidine gluconate 0.12%.
- Prescribe systemic antibiotics and analgesics if needed.
- Fabricate a soft acrylic stent to cover areas of exposed bone, protect adjacent soft tissues, and improve comfort.
- Suggest cessation of bisphosphonate therapy until osteonecrosis heals or the underlying diseases progresses (discussion with patient's medical providers).

Adapted from Kelsey JL: Musculoskeletal conditions. In Lamster IB, Northridge ME, editors: *Improving oral health for the elderly*, New York, 2008, Springer, with permission.

of this condition is of paramount importance for these patients so that they can receive the anticancer therapies required for the best possible outcome of their neoplastic disease. The most current recommendations for the dental management of patients with ONJ (MRONJ) are summarized in [Box 17.4](#).⁵⁸⁻⁶⁴ The recommendations to dental professionals for managing patients on bisphosphonates therapy are also presented in [Box 17.4](#).⁵⁸⁻⁶⁴

Accordingly, the dental management program for patients taking oral bisphosphonates should include the following elements:

1. Medical consultation to determine the medical diagnoses and type of drugs taken and ideally performance of all necessary dental treatments performed before administration of the drug(s) (similar to the approach indicated for patients undergoing head and neck radiation therapy)
2. Protocol for prevention of complications from cancer chemo- or radiation therapy:
 - a. Comprehensive examination
 - b. Establishment of excellent periodontal health (through eradication of any infection or inflammation)
 - c. Immediate extraction of all nonrestorable or questionable teeth
 - d. Elimination of dental caries
 - e. Maintenance of excellent oral hygiene and oral health

3. Routine dental care can and should be provided using routine local anesthetics.
4. All procedures should be performed as atraumatically as possible with little tissue trauma, bleeding, and risk for postoperative infection.
5. Specific precautions may be necessary for special types of procedures (i.e., orthodontic, endodontic, prosthodontic, others). Of course, oral surgery and periodontal procedures involving the manipulation of bone present the greatest risk.⁵¹
6. If ONJ occurs, no definitive treatment is available at this time; however, some recommendations are as follows:
 - a. Antimicrobial rinses (e.g., chlorhexidine 0.12%)
 - b. Surgical treatment should be conservative or delayed and be limited to (1) removal of sharp bony edges to prevent trauma to adjacent soft tissues, (2) removal of loose segments of bony sequestra without exposing uninvolved bone, and (3) segmental jaw resection for symptomatic patients with large segments of necrotic bone or pathologic fracture.
 - c. There is no empirical evidence to inform the decision of whether to cease bisphosphonate therapy in the event of development of ONJ. The AAOMS guidelines recommend that the indication for bisphosphonate therapy be considered and bisphosphonate therapy stopped only if the systemic condition permits. Hence, management is interdisciplinary and involves ongoing close monitoring. Recommencement of bisphosphonate therapy should be with either oral non-NBPs or a reduced frequency of IV NBPs, clinical condition permitting.⁶³
7. In the instance of any infection, aggressive use of systemic antibiotics is indicated.

As noted, prevention of this condition is of paramount importance for optimal outcomes for these patients.⁵⁸⁻⁶⁴

REFERENCES

1. Montella K. Common medical problems in pregnancy. In: Goldman L, Schafer AI, eds., *Cecil Textbook of Medicine*. 25th ed. Elsevier; 2015:1555-1565. ISBN 978-1-4377-1604-7 [Chapter 247].
2. http://www.cdc.gov/nchs/data_access/vitalstatsonline.htmftp://ftp.cdc.gov/pub/Health_Statistics/NCHS/Dataset_Documentation/DVS/nativity/UserGuide2014.pdf and <http://www.businessinsider.com/average-age-of-mother-having-first-child-going-up-2015-6>. Accessed 16 January 2017.
3. <http://www.fda.gov/Drugs/DevelopmentApprovalProcess/DevelopmentResources/Labeling/ucm093307.htm> Pregnancy drug labeling. Accessed 16 January 2017.
4. Donaldson M, Goodchild JH. Pregnancy, breast-feeding and drugs used in dentistry. *J Am Dent Assoc*. 2012;143(8):858-864. <http://jada.ada.org>.
5. Hagai A, Daiv-Criton O, Schecttman S, et al. Pregnancy outcome after in utero exposure to local anesthetics as

- part of dental treatment: a prospective comparative cohort study. *J Am Dent Assoc.* 2015;146(8):572-580.
6. Naccasha N, Gervasi MT, Chaiworapongsa T, et al. Phenotypic and metabolic characteristics of monocytes and granulocytes in normal pregnancy and maternal infection. *Am J Obstet Gynecol.* 2001;185(11):18.
 7. Furneaux EC, Langley-Evans AJ, Langley-Evans SC. Nausea and vomiting of pregnancy: endocrine basis and contribution to pregnancy outcome. *Obstet Gynecol Surv.* 2001;56(12):775-782.
 8. Simpson JL, Jauniaux ERM. Pregnancy loss. In: Gabbe SG, Niebyl JR, Simpson JL, eds. *Obstetrics: Normal and Problem Pregnancies.* Philadelphia: Churchill Livingstone Elsevier; 2007.
 9. Solomon CG, Seely EW. Brief review: hypertension in pregnancy: a manifestation of the insulin resistance syndrome? *Hypertension.* 2001;37(2):232-239.
 10. Offenbacher S, Boggess KA, Murtha A, et al. Progressive periodontal disease and risk of very preterm delivery. *Obstet Gynecol.* 2006;107(1):29-36.
 11. Uppal A, Uppal S, Pinto A, et al. The effectiveness of periodontal disease treatment during pregnancy in reducing the risk of experiencing preterm birth and low birth weight: a meta-analysis. *J Am Dent Assoc.* 2010;141(12):1423-1434.
 12. Michalowicz BS, Hodges JS, DiAngelis AJ, et al; OPT Study. Treatment of periodontal disease and the risk of preterm birth. *N Engl J Med.* 2006;355(18):1885-1894.
 13. Kohler B, Andreen I. Influence of caries-preventive measures in mothers on cariogenic bacteria and caries experience in their children. *Arch Oral Biol.* 1994;39(10):907-911.
 14. Rakchanok N, Amporn D, Yoshida Y, et al. Dental caries and gingivitis among pregnant and non-pregnant women in Chiang Mai, Thailand. *Nagoya J Med Sci.* 2010;72(1-2):43-50.
 15. Brambilla E, Felloni A, Gagliani M, et al. Caries prevention during pregnancy: results of a 30-month study. *J Am Dent Assoc.* 1998;129(7):871-877.
 16. Glenn FB, Glenn WD 3rd, Duncan RC. Immunity conveyed by sodium-fluoride supplement during pregnancy: part II. *ASDC J Dent Child.* 1979;46(1):17-24.
 17. Glenn FB, Glenn WD 3rd, Duncan RC. Fluoride tablet supplementation during pregnancy for caries immunity: a study of the offspring produced. *Am J Obstet Gynecol.* 1982;143(5):560-564.
 18. Leverett DH, Adair SM, Vaughan BW, et al. Randomized clinical trial of the effect of prenatal fluoride supplements in preventing dental caries. *Caries Res.* 1997;31(3):174-179.
 19. Sa Roriz Fonteles C, Zero DT, Moss ME, et al. Fluoride concentrations in enamel and dentin of primary teeth after pre- and postnatal fluoride exposure. *Caries Res.* 2005;39(6):505-508.
 20. Horowitz HS. The 2001 CDC recommendations for using fluoride to prevent and control dental caries in the United States. *J Public Health Dent.* 2003;63(1):3-8, discussion 9-10.
 21. White SC, Pharoah MJ. *Oral Radiology. Principles and Interpretation.* 6th ed. St. Louis: Mosby Elsevier; 2009.
 22. De Santis M, Di Gianantonio E, Straface G, et al. Ionizing radiations in pregnancy and teratogenesis: a review of literature. *Reprod Toxicol.* 2005;20(3):323-329.
 23. Pediatrics, A.A.o. and A.C.o.O.a. Gynecologists. *Guidelines for Perinatal Care.* 3rd ed. Elk Grove, IL; 1992.
 24. American College of Obstetricians and Gynecologists, C.o.O.P. *Guidelines for Diagnostic Imaging During Pregnancy.* ACOG Committee Opinion no. 158. Washington, DC: ACOG; 1995.
 25. Brent RL. The effects of ionizing radiation, microwaves, and ultrasound on the developing embryo: clinical interpretations and applications of the data. *Curr Probl Pediatr.* 1984;14(9):1-87.
 26. Timins JK. Radiation during pregnancy. *N J Med.* 2001;98(6):29-33.
 27. Streffer C, Shore R, Konermann G, et al. Biological effects after prenatal irradiation (embryo and fetus). A report of the International Commission on Radiological Protection. *Ann ICRP.* 2003;33(1-2):5-206.
 28. Hujoel PP, Bollen AM, Noonan CJ, et al. Antepartum dental radiography and infant low birth weight. *JAMA.* 2004;291(16):1987-1993.
 29. Mole RH. Detriment in humans after irradiation in utero. *Int J Radiat Biol.* 1991;60(3):561-564.
 30. Gonad doses and genetically significant dose from diagnostic radiology: United States, 1964 and 1970. D.o.H.E.a.W. (DHEW), Editor. 1976: Washington, DC.
 31. Freeman JP, Brand JW. Radiation doses of commonly used dental radiographic surveys. *Oral Surg Oral Med Oral Pathol.* 1994;77(3):285-289.
 32. (NCRP), N.C.o.R.P.a.M. Recommendations on Limits for Exposure to Ionizing Radiation. 1987: Bethesda, MD.
 33. Drug Administration During Pregnancy and Breast Feeding in dental patients. <http://www.fda.gov/Drugs/DevelopmentApprovalProcess/DevelopmentResources/Labeling/ucm093307.htm>.
 34. Patrick SW, Dudley J, Martin PR, et al. Prescription opioid epidemic and infant outcomes. *Pediatrics.* 2015;135(5):842-850.
 35. Rayburn WF, Amanze AC. Prescribing medications safely during pregnancy. *Med Clin North Am.* 2008;92(5):1227-1237, xii.
 36. Antibiotic interference with oral contraceptives. *J Am Dent Assoc.* 2002;133(7):880.
 37. Crawford JS, Lewis M. Nitrous oxide in early human pregnancy. *Anaesthesia.* 1986;41(9):900-905.
 38. Czeizel AE, Pataki T, Rockenbauer M. Reproductive outcome after exposure to surgery under anesthesia during pregnancy. *Arch Gynecol Obstet.* 1998;261(4):193-199.
 39. Nitrous oxide in the dental office. ADA Council on Scientific Affairs; ADA Council on Dental Practice. *J Am Dent Assoc.* 1997;128(3):364-365.
 40. Control of nitrous oxide in dental operatories. National Institute for Occupational Safety and Health. *Appl Occup Environ Hyg.* 1999;14(4):218-220.
 41. Transfer of drugs and other chemicals into human milk. *Pediatrics.* 2001;108(3):776-789.
 42. Dental devices: classification of dental amalgam, reclassification of dental mercury, designation of special

- controls for dental amalgam, mercury, and amalgam alloy. Final rule. *Fed Regist.* 2009;74(148):38685-38714.
43. Caufield PW. Dental caries—a transmissible and infectious disease revisited: a position paper. *Pediatr Dent.* 1997;19(8):491-498.
 44. Osteoporosis: pathophysiology and treatment. WHO. publication no. 1750-992399. 2016: www.who.int/chp/topics/Osteoporosis.pdf.
 45. Rosen C. Osteoporosis. In: Goldman L, Schafer AI, eds. *Cecil Textbook of Medicine*. 25th ed. Elsevier; 2015:1577-1587. ISBN 978-1-4377-1604-7 [Chapter 251].
 46. Lewiecki EM, Bilezikian JP, Bonewald L, et al. Osteoporosis update: proceedings of the 2013 Santa Fe Bone Symposium. *J Clin Densitom.* 2014;17:330e343.
 47. Das S, Crockett JC. Osteoporosis – a current view of pharmacological prevention and treatment. *Drug Des Devel Ther.* 2013;7:435-448.
 48. Whittier X, Saag KG. Glucocorticoid-induced osteoporosis. *Rheum Dis Clin North Am.* 2015;42(1):177-189.
 49. Williams MF, London DA, Husni ME, et al. Type 2 diabetes and osteoporosis. *J Diabetes Complications.* 2016;30(5):944-950.
 50. Efficacy of osteoporosis pharmacotherapies in preventing fracture among oral glucocorticoid users: a network meta-analysis. *Osteoporos Int.* 2016 Jan 18;[Epub ahead of print].
 51. Petty SJ, Wilding H, Wark JD. Osteoporosis associated with epilepsy and the use of anti-epileptics-a review. *Curr Osteoporos Rep.* 2016;14(2):54-65.
 52. Karjalainen JP, Riekkinen O, Töyräs J, et al. New method of ultrasound method for osteoporosis diagnostics at primary health care. *Osteoporos Int.* 2015;26(11):2605-2611.
 53. Karjalainen JP, Riekkinen O, Töyräs J, et al. Multi-site bone ultrasound measurements in elderly women with and without previous hip fractures. *Osteoporos Int.* 2012;23(4):1287-1295.
 54. Adapted from Kelsey JL. Musculoskeletal conditions. In: Lamster IB, Northridge ME, eds. *Improving Oral Health for the Elderly*. New York: Springer; 2008; with permission.
 55. <http://www.dentistryiq.com/articles/2013/11/what-does-osteoporosis-have-to-do-with-oral-health.html>. Accessed 2 March 2017.
 56. Darcey J, Devlin H, La D, et al. An observational study to assess the association between osteoporosis and periodontal disease. *Br Dent J.* 2013;215(12):324-334.
 57. Chen H, Liu N, Xu X, et al. Smoking, radiotherapy, diabetes and osteoporosis as risk factors for dental implant failure: a meta-analysis. *PLoS ONE.* 2013;8(8):1955-1965.
 58. Migliorati CA, Casiglia J, Epstein J, et al. Managing the care of patients with bisphosphonate-associated osteonecrosis: an American Academy of Oral Medicine position paper. *J Am Dent Assoc.* 2005;136:1658-1668.
 59. Markiewicz MR, Margarone JE 3rd, Campbell JH, et al. Bisphosphonate-associated osteonecrosis (BON) of the jaws: a review. *J Am Dent Assoc.* 2005;136:1669-1676.
 60. Nakamura T, Ito M, Hashimoto M. Clinical efficacy and safety of monthly oral ibandronate 100 mg versus monthly intravenous ibandronate 1 mg in Japanese patients with primary osteoporosis. *Osteoporos Int.* 2015;26(11):2685-2693.
 61. Ruggiero SL, Dodson TB, Assael LA, et al; Task Force on Bisphosphonate-Related Osteonecrosis of the Jaws, American Association of Oral and Maxillofacial Surgeons. American Association of Oral and Maxillofacial Surgeons position paper on bisphosphonate-related osteonecrosis of the jaw—2009 update. *Aust Endod J.* 2009;35:119-130.
 62. Rhodus NL. What is your diagnosis?: osteonecrosis of the jaw. *Northwest Dent.* 2009;889(2):24-28.
 63. Ruggiero SL, Dodson TB, Fantasia J, et al. American Association of Oral and Maxillofacial Surgeons position paper on medication-related osteonecrosis of the jaw—2014 update. *J Oral Maxillofac Surg.* 2014;72:1938-1956.
 64. Borromeo GL, Tsao CE, Darby IB, et al. A review of the clinical implications of bisphosphonates in dentistry. *Aust Dent J.* 2011;56:2-9.
 65. Yagiela JA. Health hazards and nitrous oxide: a time for reappraisal. *Anesth Prog.* 1991;38:1-11.

PART VII

Immunologic Disease

AIDS, HIV Infection, and Related Conditions

DEFINITION

On June 5, 1981, when the Centers for Disease Control and Prevention (CDC) reported five cases of *Pneumocystis carinii* (now *jiroveci*) pneumonia in young homosexual men in Los Angeles, few suspected that it heralded a pandemic of acquired immunodeficiency syndrome (AIDS). In 1983, a retrovirus (later named the human immunodeficiency virus [HIV]) was isolated from a patient with AIDS. Since that first report, more than 70 million persons have been infected with HIV, and more than 30 million have died of AIDS.¹ The total number of deaths has exceeded those caused by the Black Death of 14th-century Europe and the influenza pandemic of 1918 and 1919. About 95% of HIV-infected persons live in low- to middle-income regions and countries and in sub-Saharan Africa. More than 40% of new infections (excluding those in infants) occur in young people 15 to 24 years of age.^{1,2}

AIDS is an infectious disease caused by HIV, which is transmitted predominantly through intimate sexual contact and by parenteral means. In view of the nature of this bloodborne pathogen, HIV infection and AIDS have important implications for dental practitioners. Although HIV has rarely been transmitted from patients to health care workers, this may occur, and patients with HIV infection or AIDS may be medically compromised and may need special dental management considerations. On the basis of current statistics, the average dental practice is predicted to encounter at least two patients infected with HIV per year.

The definition of AIDS provided by the CDC has been revised several times over the years, and in 2008, it was revised to be *laboratory-confirmed evidence of HIV infection in a person who has stage 3 HIV infection* (i.e., a CD4+ lymphocyte count <200 cells/ μ L).^{3,4} This definition also includes HIV-infected persons whose CD4+ count may be above 200/ μ L but have an AIDS-defining condition, as shown in [Box 18.1](#). Of note, because of the provision of antiretroviral drug regimens, not all patients progress to AIDS or develop life-threatening opportunistic infections.^{3,4}

CRITICAL COMPLICATIONS: Patients with HIV/AIDS undergoing dental treatment may not be diagnosed and may be at risk for either transmitting the infection or sustaining complications such as infection, bleeding, drug interactions, and side effects. These events could prove serious. Dentists must be

able to identify these patients, assess risk based on history and clinical findings, and work closely with the managing physician to develop a dental management plan that will be effective and safe for the patient as well as others.

INCIDENCE AND PREVALENCE

An estimated 2.7 million people across the globe are newly infected with HIV annually.¹

Since the onset of the worldwide pandemic, more than 70,000,000 people have been infected with HIV, of whom approximately 35,000,000 have died as a consequence of AIDS^{3,4} ([Tables 18.1](#) and [18.2](#)). HIV prevention efforts have been “front and center” since the virus was discovered as the cause of AIDS, and behavioral interventions focused on HIV-negative persons have likely played a role in the falling population level incidence in some countries reported by the United Nations Program in HIV/AIDS (UNAIDS) in its 2012 report.³

A majority of those infected are between 25 and 29 years of age, male, and disproportionately black. Recent estimates for cases of HIV infection diagnosed in the United States by age, race, and transmission category are shown in [Table 18.1](#).

From 2010 through 2014, the rate for persons aged 25 to 29 years increased. The rates for children (aged younger than 13 years) and persons aged 13 to 14, 15 to 19, 35 to 39, 40 to 44, 45 to 49, 50 to 54, 55 to 59, and 60 to 64 years decreased. The rates for persons aged 20 to 24, 30 to 34, and 65 years and older remained stable. In 2014, the highest rate was for persons aged 25 to 29 years (35.8 in 100,000), followed by the rate for persons aged 20 to 24 years (34.3 in 100,000).^{1,2}

Overall in the United States, the estimated rate of HIV infection in 2014 was 13.8 in 100,000.

Race and Ethnicity: From 2010 through 2014, the rates for American Indians and Alaska Natives and Asians increased. The rates for blacks and African Americans, Native Hawaiians and other Pacific Islanders, and persons of multiple races decreased. The rates for Hispanics and Latinos and whites remained stable. In 2014, the rates were 49.4 in 100,000 for blacks and African Americans, 18.4 in 100,000 for Hispanics and Latinos, 15.4 in 100,000 for persons of multiple races, 10.6 in 100,000 for Native Hawaiians and other Pacific Islanders, 9.5 in 100,000 for American Indians and Alaska Natives, 6.2 in 100,000 for Asians, and 6.1 in 100,000 for whites.^{1,2}

BOX 18.1 AIDS-Defining Conditions

- Bacterial infections, multiple or recurrent*
- Candidiasis of bronchi, trachea, or lungs
- Candidiasis of esophagus[†]
- Cervical cancer, invasive[†]
- Coccidioidomycosis, disseminated or extrapulmonary
- Cryptococcosis, extrapulmonary
- Cryptosporidiosis, chronic intestinal (>1 month in duration)
- Cytomegalovirus disease (other than liver, spleen, or nodes), onset at age >1 month
- Cytomegalovirus retinitis (with loss of vision)[†]
- Encephalopathy, HIV related
- Herpes simplex: chronic ulcers (>1 month's duration) or bronchitis, pneumonitis, or esophagitis (onset at age >1 month)
- Histoplasmosis, disseminated or extrapulmonary
- Isosporiasis, chronic intestinal (>1 month's duration)
- Kaposi sarcoma[†]
- Lymphoid interstitial pneumonia or pulmonary lymphoid hyperplasia complex^{*†}
- Lymphoma, Burkitt (or equivalent term)
- Lymphoma, immunoblastic (or equivalent term)
- Lymphoma, primary, of brain
- *Mycobacterium avium* complex or *Mycobacterium kansasii* infection, disseminated or extrapulmonary[†]
- *Mycobacterium tuberculosis* infection of any site, pulmonary,^{††} disseminated,[†] or extrapulmonary[†]
- *Mycobacterium* infection, other species or unidentified species, disseminated[†] or extrapulmonary[†]
- *Pneumocystis jiroveci* pneumonia[†]
- Pneumonia, recurrent^{††}
- Progressive multifocal leukoencephalopathy
- *Salmonella* septicemia, recurrent
- Toxoplasmosis of brain, onset at age >1 month[†]
- Wasting syndrome attributed to HIV

*Only among children younger than 13 years of age. (Data from Centers for Disease Control and Prevention: 1994 revised classification system for human immunodeficiency virus infection in children less than 13 years of age, *MMWR Recomm Rep* 43:1, 1994 and Centers for Disease Control and Prevention: 2008 revised surveillance case definitions for HIV infection among adults, adolescents, and children aged <18 months and for HIV infection and AIDS among children aged 18 months to <13 years—United States, *MMWR Recomm Rep* 57:9, 2008.)

[†]Condition that might be diagnosed presumptively.

^{††}Only among adults and adolescents 13 years of age and older. (Data from Centers for Disease Control and Prevention: 1993 Revised classification system for HIV infection and expanded surveillance case definition for AIDS among adolescents and adults, *MMWR Recomm Rep* 41:1, 1993.)

Sex: From 2010 through 2014, the rate for female adults and adolescents decreased; the rate for males remained stable. In 2014, males accounted for 81% of all diagnoses of HIV infection among adults and adolescents. The rate for male adults and adolescents was 27.4 in 100,000, and the rate for females was 6.1 in 100,000.^{1,2}

Transmission Category: From 2010 through 2014, among male adults and adolescents, the annual number of diagnosed HIV infections attributed to male-to-male sexual contact increased. The number of infections

attributed to injection drug use, male-to-male sexual contact *and* injection drug use, or heterosexual contact decreased. Among female adults and adolescents, the number of infections attributed to injection drug use or heterosexual contact decreased. In 2014, among male and female adults and adolescents, the diagnosed infections attributed to male-to-male sexual contact (70%, including male-to-male sexual contact *and* injection drug use), and those attributed to heterosexual contact (24%) accounted for approximately 94% of diagnosed HIV infections in the United States.^{1,2}

The estimated number of AIDS diagnoses in the United States for 2014 was approximately 15,600^{1,2} (see [Table 18.2](#)). Adult and adolescent AIDS accounted for about 99% of the cases, 75% of which occurred in males and 25% in females. The cumulative estimated number of AIDS diagnoses through 2014 in the United States was approximately 1.2 million.^{1,2}

Since the introduction of protease inhibitors in 1996 and the advent of highly active antiretroviral therapy (HAART), the epidemic of AIDS in the United States has slowed and stabilized.^{3,4} As of the end of 2014, approximately 566,000 deaths have been reported in the United States from AIDS. In the United States, AIDS is the leading cause of death in men 25 to 44 years of age. Worldwide, there are 2 million deaths per year, and more than 30 million persons have died of AIDS³⁻⁵ (see [Table 18.2](#)).

With improved survival of persons with HIV infection, fortunately, there are more people living with HIV infection and therefore more people who may seek dental treatment. Consequently, dentists will be treating more people living with HIV infection. At present, there is no effective vaccine to prevent HIV infection, although large research efforts have and continue to be made in this arena. Also, a nonpandemic relating strain of HIV, known as HIV-2, occurs less commonly throughout the world.⁶ Most cases of HIV-2 infection have occurred in West Africa, with a limited number of cases occurring in Canada and the United States. Most persons infected with HIV-2 are long-term nonprogressors because viral loads generally are low, and the immunosuppression is not as severe.⁴⁻⁶

ETIOLOGY

AIDS is caused by HIV, a nontransforming retrovirus of the lentivirus family. There are two HIV subtypes, HIV-1 and HIV-2, and many strains of each. HIV-1 was first identified in 1983 by Françoise Barre-Sinoussi in the laboratory of Luc Montagnier of the Pasteur Institute. They first called it *lymphadenopathy-associated virus*.⁷ Within 1 year of this discovery, a team led by Robert Gallo from the National Institutes of Health (NIH) isolated a retrovirus identified as the human T lymphotropic virus III (HTLV-III) and labeled it as the etiologic agent for AIDS.⁸ In 1984, Jay Levy's team in San Francisco also isolated a retrovirus, AIDS-related virus (ARV), and designated it as the causative agent for AIDS.⁹ All three

TABLE 18.1 Select Patient Characteristics in HIV Infection

	2010			2011			2012			2013			2014		
	Estimated*			Estimated*			Estimated*			Estimated*			Estimated*		
	No.	No.	Rate	No.	No.	Rate	No.	No.	Rate	No.	No.	Rate	No.	No.	Rate
AGE AT DIAGNOSIS (YR)															
<13	232	238	0.4	192	198	0.4	240	250	0.5	180	191	0.4	159	174	0.3
13–14	42	43	0.5	43	45	0.5	44	46	0.6	40	43	0.5	33	35	0.4
15–19	2071	2118	9.6	2002	2068	9.5	1875	1964	9.2	1689	1792	8.5	1664	1828	8.7
20–24	7079	7245	33.4	7069	7311	33.0	7157	7489	33.1	7035	7483	32.7	7144	7868	34.3
25–29	6366	6520	30.8	6346	6563	30.8	6470	6777	31.7	6711	7151	33.1	7114	7870	35.8
30–34	5504	5639	28.1	5272	5455	26.6	5472	5729	27.4	5235	5574	26.2	5449	6026	28.0
35–39	5046	5171	25.8	4463	4622	23.6	4176	4374	22.4	4031	4288	21.8	4212	4662	23.4
40–44	5230	5361	25.6	4800	4971	23.6	4433	4646	22.1	3997	4257	20.4	3799	4196	20.4
45–49	4851	4972	22.0	4595	4758	21.5	4317	4527	20.8	3995	4268	20.1	3647	4021	19.3
50–54	3510	3602	16.1	3364	3487	15.4	3219	3377	14.9	3024	3235	14.3	2928	3242	14.4
55–59	2077	2132	10.8	1999	2072	10.2	1923	2019	9.7	2047	2184	10.3	1949	2166	10.1
60–64	1064	1091	6.4	1072	1111	6.2	1052	1106	6.2	1098	1170	6.5	960	1069	5.8
≥65	790	810	2.0	816	848	2.0	819	861	2.0	867	930	2.1	819	914	2.0
RACE/ETHNICITY															
American Indian or Alaska Native	174	177	7.8	159	163	7.1	187	193	8.4	178	186	8.0	208	222	9.5
Asian	708	727	4.9	774	802	5.3	809	848	5.4	809	859	5.3	941	1046	6.2
Black or African American	20,461	20,987	55.2	19,345	20,064	52.3	18,632	19,581	50.5	17,993	19,252	49.2	17,592	19,540	49.4
Hispanic or Latino [†]	9072	9291	18.3	8919	9230	17.8	8954	9372	17.7	8829	9386	17.3	9227	10,201	18.4
Native Hawaiian or other Pacific Islander	57	58	11.7	56	58	11.4	58	60	11.6	54	56	10.6	53	58	10.6
White	11,864	12,135	6.1	11,376	11,738	5.9	11,259	11,752	5.9	10,914	11,581	5.9	10,967	12,025	6.1
Multiple races	1526	1565	27.7	1404	1456	25.0	1298	1358	22.6	1172	1246	20.1	889	982	15.4
TRANSMISSION CATEGORY															
Male Adult or Adolescent															
Male-to-male sexual contact	21,834	27,034	—	21,828	27,001	—	21,758	27,588	—	21,594	27,642	—	21,566	29,418	—
Injection drug use	1307	2115	—	1080	1819	—	916	1642	—	874	1575	—	809	1590	—
Male-to-male sexual contact and injection drug use	1238	1562	—	1100	1393	—	1036	1342	—	924	1216	—	870	1217	—
Heterosexual contact [‡]	2891	4111	—	2739	3683	—	2500	3617	—	2398	3545	—	2049	3285	—
Other [§]	6771	52	—	6245	50	—	6491	69	—	6163	57	—	6891	60	—
Subtotal	34,041	34,871	27.9	32,992	34,146	27.0	32,701	34,259	26.9	31,953	34,034	26.4	32,185	35,571	27.4
Female Adult or Adolescent															
Injection drug use	803	1455	—	672	1284	—	617	1178	—	559	1073	—	495	1045	—
Heterosexual contact [‡]	4740	8340	—	4307	7833	—	3905	7439	—	3782	7213	—	3282	7242	—
Other [§]	4046	36	—	3870	49	—	3734	39	—	3475	55	—	3756	41	—
Subtotal	9589	9831	7.5	8849	9166	6.9	8256	8656	6.5	7816	8340	6.2	7533	8328	6.1
Child (<13 yr at Diagnosis)															
Perinatal	181	185	—	142	147	—	168	175	—	119	127	—	115	127	—
Other	51	53	—	50	51	—	72	75	—	61	64	—	44	48	—
Subtotal	232	238	0.4	192	198	0.4	240	250	0.5	180	191	0.4	159	174	0.3

Continued

TABLE 18.1 Select Patient Characteristics in HIV Infection—cont'd

	2010			2011			2012			2013			2014		
	Estimated*			Estimated*			Estimated*			Estimated*			Estimated*		
	No.	No.	Rate	No.	No.	Rate	No.	No.	Rate	No.	No.	Rate	No.	No.	Rate
REGION OF RESIDENCE															
Northeast	8381	8597	15.5	7800	8087	14.5	7646	8039	14.4	7236	7750	13.8	7137	7953	14.2
Midwest	5554	5664	8.5	5424	5580	8.3	5507	5717	8.5	5376	5654	8.4	5099	5529	8.2
South	21,997	22,550	19.6	21,316	22,079	19.0	20,469	21,480	18.3	20,131	21,508	18.1	20,065	22,196	18.5
West	7930	8129	11.3	7493	7764	10.7	7575	7929	10.8	7206	7654	10.3	7576	8395	11.2
Total[¶]	43,862	44,940	14.5	42,033	43,510	14.0	41,197	43,165	13.7	39,949	42,566	13.4	39,877	44,073	13.8

Note. Data include persons with a diagnosis of HIV infection regardless of stage of disease at diagnosis.

*Estimated numbers resulted from statistical adjustment that accounted for reporting delays and missing transmission category but not for incomplete reporting. Rates are per 100,000 population. Rates are not calculated by transmission category because of the lack of denominator data.

[†]Hispanics and Latinos can be of any race.

[‡]Heterosexual contact with a person known to have or to be at high risk for HIV infection.

[§]Includes hemophilia, blood transfusion, perinatal exposure, and risk factor not reported or not identified.

^{||}Includes hemophilia, blood transfusion, and risk factor not reported or not identified.

[¶]Because column totals for estimated numbers were calculated independently of the values for the subpopulations, the values in each column may not sum to the column total.

This is from <http://www.cdc.gov/hiv/pdf/library/reports/surveillance/cdc-hiv-surveillance-report-us.pdf> (pages 18 and 19).

TABLE 18.2 Select Patient Characteristics in AIDS

	2010			2011			2012			2013			2014			Cumulative [†]	
	Estimated*			Estimated*			Estimated*			Estimated*			Estimated*				
	No.	No.	Rate	No.	No.	Rate	No.	No.	Rate	No.	No.	Rate	No.	No.	Rate	No.	Est. No.*
AGE AT DIAGNOSIS (YR)																	
<13c	21	21	0.0	15	15	0.0	10	10	0.0	8	8	0.0	94	104	0.2	9561	9588
13–14	49	50	0.6	40	42	0.5	30	31	0.4	28	30	0.4	20	22	0.3	1462	1477
15–19	451	461	2.1	426	440	2.0	349	363	1.7	401	423	2.0	207	227	1.1	8909	9027
20–24	1989	2038	9.4	1970	2042	9.2	1895	1981	8.8	2001	2112	9.2	1339	1467	6.4	51,371	51,986
25–29	2886	2956	14.0	2776	2877	13.5	2730	2853	13.3	2809	2974	13.8	2303	2531	11.5	141,002	142,069
30–34	3305	3382	16.9	3133	3242	15.8	3236	3377	16.1	2931	3099	14.6	2368	2598	12.1	224,940	226,254
35–39	3717	3804	18.9	3205	3318	16.9	2919	3047	15.6	2848	3010	15.3	2330	2556	12.8	243,597	245,042
40–44	4324	4425	21.2	3776	3909	18.6	3431	3577	17.0	3095	3270	15.7	2424	2659	12.9	204,493	205,990
45–49	4292	4392	19.4	3965	4107	18.5	3650	3805	17.5	3344	3534	16.6	2611	2866	13.7	139,973	141,345
50–54	3168	3240	14.5	2908	3009	13.3	2888	3010	13.3	2807	2963	13.1	2253	2468	10.9	83,736	84,738
55–59	1761	1801	9.1	1802	1863	9.2	1771	1848	8.9	1796	1893	8.9	1548	1702	7.9	46,497	47,105
60–64	936	957	5.6	906	936	5.3	991	1033	5.8	1031	1087	6.0	835	913	4.9	24,762	25,078
≥65	742	759	1.9	721	744	1.8	722	751	1.7	769	811	1.8	713	784	1.7	20,882	21,137
RACE/ETHNICITY																	
American Indian or Alaska Native	116	118	5.2	103	105	4.6	94	96	4.2	91	94	4.0	90	95	4.0	3498	3523
Asian [§]	363	372	2.5	362	375	2.5	354	369	2.3	358	379	2.3	323	352	2.1	9689	9815
Black or African American	13,419	13,745	36.2	12,363	12,816	33.4	12,030	12,574	32.4	11,548	12,219	31.2	9119	10,045	25.4	499,734	504,354
Hispanic or Latino	5617	5745	11.3	5237	5415	10.4	5015	5222	9.8	4868	5132	9.5	3924	4279	7.7	217,650	219,578
Native Hawaiian or other Pacific Islander	39	40	8.0	31	32	6.3	26	27	5.2	27	28	5.2	18	19	3.5	842	850
White	6953	7102	3.6	6483	6693	3.4	6111	6354	3.2	6005	6328	3.2	4850	5303	2.7	436,952	439,455
Multiple races	1134	1165	20.6	1064	1108	19.0	992	1044	17.4	971	1034	16.7	721	803	12.6	32,820	33,260

TABLE 18.2 Select Patient Characteristics in AIDS—cont'd

	2010			2011			2012			2013			2014			Cumulative†	
	Estimated*			Estimated*			Estimated*			Estimated*			Estimated*			No.	Est. No.*
	No.	No.	Rate	No.	No.	Rate	No.	No.	Rate	No.	No.	Rate	No.	No.	Rate	No.	Est. No.*
TRANSMISSION CATEGORY																	
Male Adult or Adolescent																	
Male-to-male sexual contact	11,695	14,448	—	11,238	13,863	—	10,826	13,664	—	10,781	13,785	—	8,180	11,277	—	529,245	586,385
Injection drug use	1485	2072	—	1240	1773	—	1116	1649	—	957	1477	—	812	1268	—	165,386	187,372
Male-to-male sexual contact and injection drug use	1177	1431	—	1018	1242	—	929	1166	—	774	1005	—	555	782	—	78,824	85,290
Heterosexual contact [‡]	2255	3092	—	2112	2896	—	1946	2728	—	1891	2730	—	1453	2211	—	66,501	84,200
Other ^{**}	4063	118	—	3613	127	—	3699	117	—	3696	133	—	3,243	85	—	107,624	11,627
Subtotal	20,675	21,161	16.9	19,221	19,901	15.8	18,516	19,324	15.2	18,099	19,130	14.9	14,243	15,624	12.0	947,580	954,875
Female Adult or Adolescent																	
Injection drug use	981	1469	—	864	1302	—	781	1205	—	671	1089	—	523	913	—	75,745	90,413
Heterosexual contact [‡]	3603	5502	—	3316	5195	—	3113	5039	—	2899	4839	—	2203	4150	—	114,383	149,980
Other ^{**}	2361	133	—	2227	131	—	2202	109	—	2191	147	—	1982	106	—	53,916	5979
Subtotal	6945	7105	5.4	6407	6628	5.0	6096	6353	4.8	5761	6075	4.5	4708	5168	3.8	244,044	246,372
Child (<13 Yr at Diagnosis)																	
Perinatal [‡]	15	15	—	12	12	—	8	8	—	8	8	—	83	92	—	8690	8715
Other ^{††}	6	6	—	3	3	—	2	2	—	0	0	—	11	12	—	871	874
Subtotal	21	21	0.0	15	15	0.0	10	10	0.0	8	8	0.0	94	104	0.2	9561	9588
REGION OF RESIDENCE^{**}																	
Northeast	5631	5782	10.4	5153	5356	9.6	4765	4992	8.9	4360	4636	8.3	3409	3793	6.8	351,863	354,392
Midwest	3365	3431	5.1	3248	3341	5.0	3106	3215	4.8	2952	3087	4.6	2431	2627	3.9	127,677	128,670
South	13,747	14,059	12.2	12,949	13,402	11.5	12,608	13,155	11.2	12,667	13,376	11.3	10,003	10,965	9.2	483,173	487,539
West	4898	5016	7.0	4293	4445	6.1	4143	4325	5.9	3889	4115	5.5	3202	3511	4.7	238,472	240,235
Total	27,641	28,287	9.1	25,643	26,545	8.5	24,622	25,687	8.2	23,868	25,214	8.0	19,045	20,896	6.6	1,201,185	1,210,835

Note. Reported numbers less than 12, as well as estimated numbers (and accompanying rates and trends) based on these numbers, should be interpreted with caution because the numbers have underlying relative standard errors greater than 30% and are considered unreliable.

*Estimated numbers resulted from statistical adjustment that accounted for reporting delays and missing transmission category but not the incomplete reporting. Rates are per 100,000 population. Rates are not calculated by transmission category because of the lack of denominator data.

†From the beginning of the epidemic through 2014.

‡The criteria for stage 3 (AIDS) classification among pediatric cases were expanded in 2014.

§Includes Asian Pacific Islander legacy cases (see Technical Notes).

||Hispanics and Latinos can be of any race.

¶Heterosexual contact with a person known to have or to be at high risk for HIV infection.

**Includes hemophilia, blood transfusion, perinatal exposure, and risk factor not reported or not identified.

††Includes hemophilia, blood transfusion, and risk factor not reported or not identified.

**Because column totals for estimated numbers were calculated independently of the values for the subpopulations, the value in each column may not sum to the column total.

This is from <http://www.cdc.gov/hiv/pdf/library/reports/surveillance/cdc-hiv-surveillance-report-us.pdf> (pages 22 and 23).

viruses were similar retroviruses, but minor differences were observed in their amino acid sequences. Variation in disease patterns are attributed to the slight sequence differences among HIV strains, which also makes difficult the production of a vaccine. The three groups essentially were describing the same retrovirus, which can change its antigenicity. Until 1986, most workers in the field referred to the virus as HTLV-III and considered it to be the causative agent for AIDS. In 1986, the World Health Organization (WHO) recommended that the AIDS virus be called the human immunodeficiency virus⁷⁻⁹ (Fig. 18.1). Subsequent analysis of frozen tissue and serum samples from select patients who died of uncertain causes in the

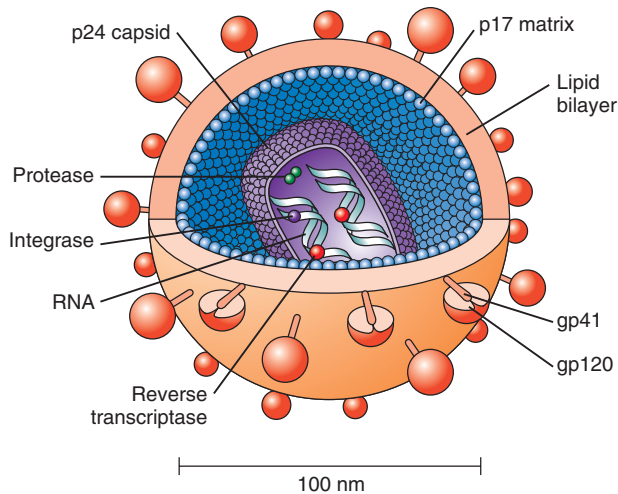

FIG 18.1 The structure of human immunodeficiency virus, showing the p24 capsid protein surrounding two strands of viral RNA. (From Copstead LC, Banasik JL: *Pathophysiology*, ed 4, St. Louis, 2010, Saunders.)

1950s and 1960s demonstrated that HIV had infected these patients, indicating its presence in humans for more than 60 years.¹⁰

HIV is an enveloped RNA retrovirus about 100 nm in diameter. Glycoproteins (gp41 and gp120) stud the surface of the envelope and serve to bind to human cells (Fig. 18.2). Internal to the envelope is a protein capsid (p24) that surrounds essential viral enzymes (protease, integrase, reverse transcriptase) and an RNA inner core. It infects most human cells. However, the cells most commonly infected are those with CD4+ receptors, including T helper lymphocytes (CD4+ cells) and macrophages. Accordingly, these cells are most deeply involved in HIV infection. Additional coreceptors that allow HIV to infect human cells include CCR5, CXCR4 (fusin), and CCR2.^{4,5,11}

HIV-1 infection is divided into stages: *entry*, *reverse transcription* of RNA to DNA, export of the viral DNA from the cytoplasm to the nucleus and *integration* into the host chromosome, *transcription*, *translation* and cleavage of the polyproteins produced, *assembly* of virions, and budding of virions. The process is largely regulated by the proteins *tat*, *rev*, and *nef*, which are necessary for viral replication. Virulence has been mapped to the carboxyl-terminal half of the gp120, which has been referred to as the V₃ loop.^{4,5,11}

Pathophysiology and Complications

Transmission of HIV is by exchange of infected bodily fluids from sexual contact and through blood and blood products. The most common method of sexual transmission in the United States is anal intercourse in men who have sex with men (MSM), in whom the risk of HIV infection is 40 times higher than in other men and in women.^{4,5,11} Heterosexual transmission (male to female

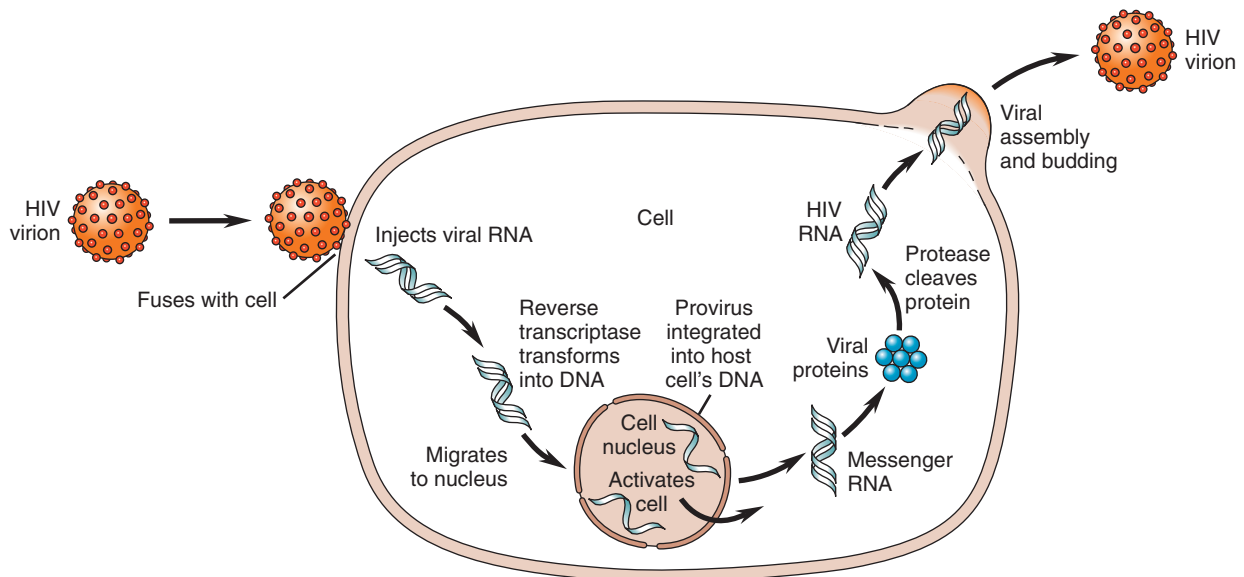

FIG 18.2 Life Cycle of the Human Immunodeficiency Virus. (From Copstead LC, Banasik JL: *Pathophysiology*, ed 4, St. Louis, 2010, Saunders.)

or female to male) is the second most common form of transmission in the United States but accounts for 80% of the world's HIV infections. Heterosexual transmission can occur through sexual contact of carriers who are heterosexual injection drug users, bisexual men, or blood recipients of either gender. Transmission from sharing needles is the third largest group affected in the United States.^{4,5,11}

HIV is found in blood, seminal fluid, vaginal secretions, tears, breast milk, cerebrospinal fluid, amniotic fluid, and urine. Blood, semen, breast milk, and vaginal secretions are the main fluids that have been shown to be associated with transmission of the virus.^{4,5,11}

Vertical transmission, from mother to infant, can occur during pregnancy, at birth, during breastfeeding, or from providing pre-masticated food from HIV-infected parents to infants.¹² Casual contact has not been demonstrated as a means of transmission. Inflammation and breaks in the skin or mucosa (e.g., presence of other sexually transmitted diseases) and high concentrations of HIV in bodily fluids increase the risk of transmission.^{13,14} The risk of transmission from a blood transfusion is estimated to be less than 1 in 1 million because of current screening measures. Occupational exposure is also a source of transmission, and transmission from health care provider to patient has occurred (see later under “[Dental Management](#)”).

After HIV has gained access to the bloodstream, the virus selectively seeks out T lymphocytes (specifically T4 or T helper lymphocytes) (see [Fig. 18.2](#)).^{4,5,11} The virus binds to the CD4+ lymphocyte cell surface specifically through the highly glycosylated outer surface envelope (gp120) proteins. Upon infection, reverse transcriptase catalyzes the synthesis of a haploid, double-stranded DNA provirus, which becomes incorporated into the chromosomal DNA of the host cell. After integration, the provirus genetic material may remain latent in an unexpressed form until events occur that activate it. Activation leads to DNA transcription and the production of new virions.^{4,5,11} The virus is lymphotropic; hence, the cells it selects for replication are soon destroyed. When the virus takes hold, the infection causes progressive loss in the total number of T helper cells and a marked shift in the ratio of CD4+ to CD8+ lymphocytes. The normal ratio of T helper to T suppressor lymphocytes is about two to one (60% T helper, 30% T suppressor). In AIDS, the T4-to-T8 ratio is reversed.^{4,5,11} This marked reduction in T helper lymphocytes, to a great degree, explains the lack of an effective immune response seen in patients with AIDS and contributes to the increase in malignant disease that has been found to be associated with AIDS, including Kaposi sarcoma, lymphoma, carcinoma of the cervix, and carcinoma of the rectum.^{5,11}

[Table 18.3](#) presents the clinical stages of HIV infection through frank AIDS. More than 50% of persons exposed to HIV develop an acute and brief viremia (seroconversion sickness) within 2 to 6 weeks of exposure and then develop

antibodies (anti-gag, anti-gp120, anti-p24) between weeks 6 and 12. A few may take 6 months or longer to achieve seroconversion. A concomitant, transient fall in CD4+ cells occurs (lymphopenia, along with high titers of plasma HIV), but patients do not develop evidence of immunosuppression. Various flulike symptoms occur during this acute infection, which usually lasts about 2 to 4 weeks. Only an estimated 20% of affected persons seek medical attention. During the early phase of HIV disease, the virus disseminates throughout lymphoid tissue, incubates, replicates, and alters many physiologic processes, resulting in hyperimmune activation, persistent inflammation, and impaired gut function and flora.^{4,11}

As time progresses, a steady-state viremia develops, and several thousand copies of HIV are present in the blood ([Fig. 18.3](#)).^{4,11} This clinical latency period is characterized by evolution of the virus within its host to generate closely related yet distinct mutant viruses that serve to evade the surveying immune response and circulating antibodies. Although the infection is clinically latent, there is a progressive decline in immune function evident as progressive depletion of CD4+ lymphocytes with ultimate pancytopenia, impaired lymphocyte proliferation, and cytokine responses to mitogens and antigens; impaired cytotoxic lymphocyte function and natural killer cell activity; anergy to skin testing; and diminished antibody responses to new antigens.^{4,11}

In untreated persons and in persons in whom therapy is ineffective, the CD4+ count continues to decline while HIV proliferates. As the CD4+ count drops and approaches 200 cells/ μ L, persons can exhibit weight loss, diarrhea, and night sweats (see [Fig. 18.3](#)).^{4,11} When the CD4+ count drops to below 200 cells/ μ L, the person has AIDS and is susceptible to opportunistic infections, including *Pneumocystis* pneumonia, toxoplasmosis, cryptococcosis, influenza, histoplasmosis, tuberculosis, and cytomegalovirus (CMV) infection; mucocutaneous diseases such as candidiasis; and neoplasms previously discussed. Neurologic disease is common and includes secondary opportunistic infections as well as primary HIV infection of macrophages, neurons, and microglial cells in the CNS that leads to rapidly progressive dementia. HIV infection also leads to immune activation and dysregulated lipid metabolism, resulting in hyperlipidemia, hypertension, cardiovascular events, diabetes, and premature aging.^{4,5,11}

Evidence suggests that persons most susceptible to developing AIDS are those with repeated exposure to the virus who also have an immune system that has been challenged by repeated exposure to various antigens (semen, hepatitis B, or blood products).^{4,5,11} The median time from primary infection to the development of AIDS in untreated patients is about 10, and notably, there are gender-based differences in HIV-pathogenesis with progression to AIDS being faster in infected women than infected men.^{5,11} About 30% of patients with AIDS can be expected to live approximately 2 to 3 years; most others live 10 years or longer. Long-term survival with HIV infection

TABLE 18.3 Features of HIV Infection and Disease Progression

Status	Signs/Symptoms	Laboratory Findings	Comments
Recent infection	No signs or symptoms	HIV nucleic acid: positive p24 antigen; positive DNA PCR assay; ELISA and Western blot may or may not be positive	Patient is unaware of his or her HIV infection. Can transmit the infection by blood or sexual activity
Stage 1: acute seroconversion syndrome	Symptoms occur within about 1–3 wk after infection in ≈70% of infected patients: fever, weakness, diarrhea, nausea, vomiting, myalgia, headache, weight loss, pharyngitis, skin rashes (roseola-like or urticarial), lymphadenopathy; symptoms clear in about 1–2 wk	HIV antibody–negative at start of syndrome Seroconversion occurs near end of the syndrome CD4+ and CD8+ lymphocytes reduced in numbers, but >500 cells/μL After acute symptoms, they tend to return toward normal levels. ELISA and Western blot are positive.	The severity of the acute syndrome varies among infected persons. The period for seroconversion of 30% of patients without acute symptoms varies and can be 1–6 mo or longer.
Stage 2: latent period (asymptomatic stage)	Median time from initial infection to onset of clinical symptoms: 8–10 years ≈50%–70% of patients develop PGL	ELISA and Western blot are positive. A slow but usually steady increase in viral load Usually, a steady decline in CD4+ cell count; CD4+/CD8+ ratio begins to approach 1	Viral replication is ongoing and progressive. A steady decline in CD4+ cell counts occurs, except in the fewer than 1% who are nonprogressors (also have low viral load).
Stage 2: early symptomatic stage	Without treatment, lasts for 1–3 yr; any of the following: PGL, fungal infections, vaginal yeast and trichomonal infections, oral hairy leukoplakia, herpes zoster, herpes simplex, HIV retinopathy Constitutional symptoms: fever, night sweats, fatigue, diarrhea, weight loss, weakness	ELISA and Western blot are positive. HIV antigen, RNA, and DNA tests are positive. Signs and symptoms increase as CD4+ cell count declines and approaches 200/μL; often between 200 and 300/μL Viral load continues to increase Platelet count may decrease in about 10% of patients.	The spectrum of disease changes as CD4+ cell count declines.
Stage 3: AIDS	Opportunistic infection(s): <i>Pneumocystis jiroveci</i> pneumonia, cryptococcosis, tuberculosis, toxoplasmosis, histoplasmosis, others Malignancies: Kaposi sarcoma, Burkitt lymphoma, non-Hodgkin lymphoma, primary CNS lymphoma, invasive cervical cancer, carcinoma of rectum, slim (wasting) disease	High viral load; CD4+ cell count <200/μL CD4+ cell count <50/μL at high risk for lymphoma and death Platelet count may be low. Neutrophil count may be low. ELISA and Western blot are positive. HIV antigen, RNA, and DNA tests are positive.	Death usually occurs because of wasting, opportunistic infection, or malignancies. The use of combination antiretroviral agents has slowed the death rate, but long-term outlook must depend on vaccines for prevention and treatment because the virus promotes resistance to these agents.

AIDS, Acquired immunodeficiency syndrome; CNS, central nervous system; ELISA, enzyme-linked immunosorbent assay; HIV, human immunodeficiency virus; PCR, polymerase chain reaction; PGL, persistent generalized lymphadenopathy.

(beyond 15 years) occurs and is associated with less virulent HIV strains, lower level viremia, HAART, and robust immune responses.^{5,11}

CLINICAL PRESENTATION

Signs and Symptoms

During the first 2 to 6 weeks after initial infection with HIV, more than 50% of patients develop an acute flulike syndrome marked by viremia that may last 10 to 14 days. Others may not manifest this symptom complex. Symptomatic persons often develop lymphadenopathy, fever, pharyngitis, and a skin rash but generally do not display

circulation antibodies until the sixth week to sixth month. The severity of the initial acute infection with HIV (i.e., level of viremia) is predictive of the course the infection will follow.^{4,5,11} In one study, 78% of persons with a long-lasting acute illness developed AIDS within 3 years; by contrast, only 10% of those patients with no acute illness at seroconversion developed AIDS within 3 years.¹⁵

The CDC defines three stages of HIV infection.¹ Box 18.2 illustrates the definitions for each stage. Briefly, stage 1 generally begins immediately after HIV exposure and may last for years. Affected persons are HIV antibody positive but are asymptomatic and show no other laboratory abnormalities. Stage 2 is characterized by progressive

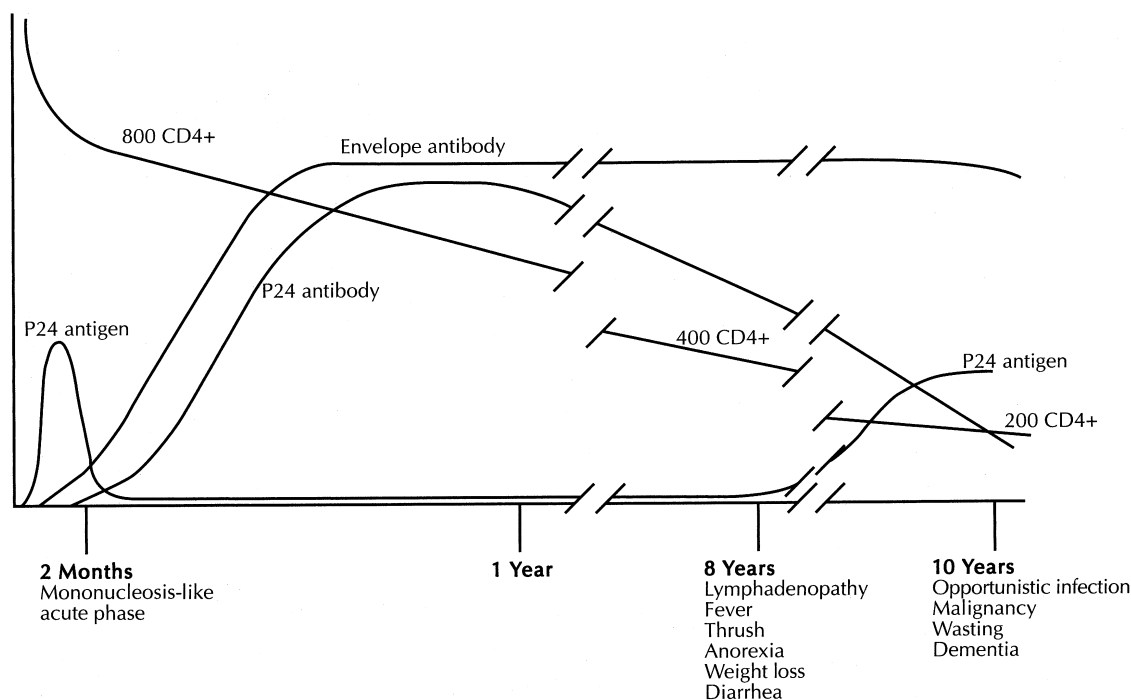

FIG 18.3 The natural history of human immunodeficiency virus infection. (From Brookmeyer R, Gail MH: *AIDS epidemiology: a quantitative approach*, New York, 1994, Oxford University Press.)

BOX 18.2 Centers for Disease Control and Prevention Staging of HIV Infection in Adults and Adolescents

Stage 1: Laboratory confirmation of HIV infection, no AIDS-defining conditions and CD4+ T lymphocyte count of ≥ 500 cells/ μ L or CD4+ T lymphocyte percentage of total lymphocytes of ≥ 29 .

Stage 2: Laboratory confirmation of HIV infection, no AIDS-defining condition, and laboratory confirmation of HIV infection and CD4+ T lymphocyte count of 200–499 cells/ μ L or CD4+ T lymphocyte percentage of total lymphocytes of 14–28.

Stage 3 (AIDS): Laboratory confirmation of HIV infection and CD4+ T lymphocyte count is < 200 cells/ μ L or CD4+ T lymphocyte percentage of total lymphocytes is < 14 or documentation of an AIDS-defining condition (see Box 18.1). Documentation of an AIDS-defining condition supersedes a CD4+ T lymphocyte count of ≥ 200 cells/ μ L and a CD4+ T lymphocyte percentage of total lymphocytes of ≥ 14 .

immunosuppression and symptomatic disease. Patients who demonstrate various laboratory changes (i.e., lymphopenia: ratio of T helper to T suppressor usually < 1) in addition to HIV antibody positivity also may show clinical signs or symptoms, such as enlarged lymph nodes, night sweats, weight loss, oral candidiasis, fever, malaise, and diarrhea. Persons in stage 3 have AIDS and can demonstrate a variety of immunosuppression-related diseases.^{4,5,11} Opportunistic infections predominate as the CD4+ T count approximates 200 cells/ μ L; then malignancies, wasting syndrome, and a progressive form of dementia can develop. Patients may become confused and disoriented

or may experience short-term memory deficits. Others develop severe depression or paranoia and show suicidal tendencies. Fig. 18.3 depicts the natural history of HIV, and Table 18.2 lists the diseases associated with the progression of HIV infection through frank AIDS.^{4,11}

Laboratory and Diagnostic Findings

Most patients exposed to the virus, with or without clinical evidence of disease, show antibodies to the virus by the sixth month of infection. Patients with advanced HIV infection or AIDS have an altered ratio of CD4+/CD8+ lymphocytes, a decrease in total number of lymphocytes, thrombocytopenia, anemia, a slight alteration in the humoral antibody system, and a decreased ability to show delayed allergic reactions to skin testing (cutaneous anergy).^{4,11} CD4+ and CD8+ cell counts should be performed at the time of HIV diagnosis and then every 3 to 4 months.^{4,11}

The enzyme-linked immunosorbent assay (ELISA) is the screening test for identification of antibodies to HIV. It is 90% sensitive but has a high rate of false-positive results. Current practice is to screen first with ELISA. If the results are positive, a second ELISA is performed. All positive results are then confirmed with Western blot analysis. This combination of tests is accurate more than 99% of the time. Positive ELISA and Western blot test results indicate only that the individual has been exposed to the AIDS virus.^{4,11} If results of the Western blot are indeterminate, HIV infection is rarely, if ever, present. These tests, however, do not indicate the status of the HIV infection or whether AIDS is present. However, patients with positive results on the ELISA and Western

blot test are considered potentially infectious. ELISA testing for HIV in saliva is an alternative approach that is 98% sensitive in detecting antibodies to HIV.^{4,16} Abbott has developed a combination assay, the ARCHITECT HIV Ag/Ab Combo assay (Abbott Laboratories, Abbott Park, IL), that can simultaneously detect the combined presence of HIV antigens (the p24 antigen produced by HIV) and antibodies to HIV. This test is important for diagnosing HIV infection in the acute phase of the disease when antibodies are not yet present and for ongoing monitoring of patients.¹⁶

Nucleic acid amplification using polymerase chain reaction (PCR)-based assays of the viral RNA is performed to determine the viral load in the blood (i.e., degree of viremia) and monitor response to therapy. Detection ranges are from 40 copies/mL to more than 750,000 copies/mL. The greatest viral load is found during the first 3 months after initial infection and during late stages of the disease. Direct detection of HIV by PCR assay is superior to testing for HIV antigen in serum but more expensive.¹⁷ Antiviral resistance testing is recommended when treatment is failing.¹⁸

MEDICAL MANAGEMENT

Medical management of the HIV-infected patient has four main treatment goals: (1) to reduce HIV-associated morbidity and prolong the duration and quality of survival, (2) to restore and preserve immunologic function, (3) to maximally and durably suppress plasma HIV viral load, and (4) to prevent HIV transmission.^{4,18} Physicians managing these patients should be experts in infectious disease and in the use of antiretroviral drugs. Antiretroviral therapy (ART) should be used in a manner that will achieve viral suppression and immune reconstitution while at the same time preventing emergence of resistance and limiting drug toxicity. Long-term goals are to delay disease progression, prolong life, and improve quality of life. Treatment often is organized into three major areas: (1) ART, (2) prophylaxis for opportunistic infections, and (3) treatment of HIV-related complications. Monitoring response to therapy is a long-term requirement because more than 70% of HIV-infected persons survive beyond 10 years from the time of diagnosis in the United States, especially if treatment is not delayed.^{4,19-22}

ART and HAART

Over the past decade, much progress has been made in the treatment of AIDS because of ART. Both ART and HAART involve use of combinations of antiretroviral drugs; however, strictly speaking, HAART is defined as the use of at least three active antiretroviral medications.

The benefits of ART are now well known. ART increases survival, reduces systemic complications, and improves the quality of life in patients infected with HIV.^{4,19-22} The major goal of ART is to inhibit HIV replication completely such that the viral load is below the

detection limit of the assay at 4 to 6 months. However, there are no conclusive studies that show when therapy should be initiated. Experts recommend starting treatment in all patients with symptoms ascribed to HIV infection, all pregnant mothers infected with HIV, and all HIV-infected infants. ART currently is recommended when the CD4+ count is less than 350 cells/ μ L and in those with plasma HIV RNA levels greater than 55,000 copies/mL.^{4,19-22} Treatment is generally initiated for asymptomatic patients who have a rapid drop in CD4+ T cell count or high viral loads. Asymptomatic patients with stable CD4+ T cell counts and low viral loads are generally followed without treatment. ART is strongly recommended for patients with CD4+ T cell counts lower than 200/ μ L and for those with AIDS.^{4,19-22}

Antiretroviral drugs are used to restore immune dysfunction by inhibiting viral replication. More than 20 antiretroviral drugs are currently available for the management of HIV infection/AIDS (Table 18.4). The antiretroviral agents available are classified into five categories: protease inhibitors (PIs), nucleoside reverse transcriptase inhibitors (NRTIs), non-nucleoside reverse transcriptase inhibitors (NNRTIs), nucleotides, and entry inhibitors. These agents usually are used in combinations known as ART or HAART and should be given long term.^{4,19-22}

The development of effective ART for HIV infection is one of the most notable achievements in modern medicine.⁴ Triple-drug therapy was first introduced in the mid-1990s and resulted in a two-thirds decrease in HIV-related deaths within 2 years in developed countries. Today, a total of 29 antiretroviral drugs are approved by the Food and Drug Administration, and three-drug combination regimens are the standard of care.^{4,19-22} The benefits of ART were extended to developing countries, and an estimated more than 16 million people currently are taking ART worldwide. The life expectancy of an HIV-infected individual appropriately treated with ART is now estimated to be nearly that of the general population, both in developed and developing countries, although it also is estimated to be about 1.7-fold higher than in healthy people with no comorbid conditions.^{4,19-22}

Current guidelines from around the world now recommend starting ART in *all* HIV-infected patients, regardless of CD4 cell count because of both clinical benefits to the patient and reduction in HIV transmission to others (Box 18.3).^{4,19-22} This recommendation is supported by the fact that current ART regimens are potent, convenient, and generally well tolerated by randomized controlled clinical trials data and by supportive clinical cohort data.^{4,19-22}

The drug regimen that is initiated should be individualized to be potent enough to suppress the viral load to below the level of assay detection for a prolonged period while reducing the virus mutation rates that can lead to drug resistance. Currently, preferred regimens for an ART-naïve patient consist of either efavirenz + tenofovir + emtricitabine or ritonavir-boosted atazanavir–darunavir plus tenofovir–emtricitabine, or raltegravir + tenofovir +

TABLE 18.4 Antiretroviral Drugs Used to Treat HIV Infection

Drug	Toxicity	Interactions	Comments
PROTEASE INHIBITORS (PIs)			
Amprenavir	Nausea, vomiting	Amiodarone	PIs act at the end of the virus replication cycle, blocking the catalytic center of the protease enzyme, resulting in viral particles that are ineffective and immature.
Atazanavir	Nausea, vomiting, liver, tingling arms or legs	Midazolam, triazolam	
Darunavir	Nausea, diarrhea, lipodystrophy	Midazolam, triazolam, quinidine	
Fosamprenavir	Nausea, vomiting	Midazolam, triazolam	
Indinavir	Diarrhea	Quinidine	
Lopinavir*	Abdominal discomfort	Rifampin	
Nelfinavir	Paresthesias	Ergotamine	
Ritonavir*	Fatigue	St. John's wort	
Saquinavir	Anemia, leukopenia Thrombocytopenia, altered taste, hypercholesterolemia, hypertriglyceridemia, xerostomia	Midazolam Triazolam	
Tipranavir	Nausea, vomiting, diarrhea, liver damage	Midazolam, triazolam, quinidine	
NUCLEOSIDE REVERSE TRANSCRIPTASE INHIBITORS (NRTIS)			
Abacavir [†]	Headache	Avoid mixing zidovudine and stavudine, ribavirin, or doxorubicin.	Drug adverse effects often are dose related and can be minimized with lower doses. Use of zalcitabine is restricted because of the small therapeutic window. Stavudine is the most frequently used drug in the group.
Emtricitabine	Insomnia		
Didanosine	Fatigue	Ganciclovir and interferon- α must be avoided.	
Lamivudine [†]	Anemia, neutropenia		
Stavudine	Nausea		
Zalcitabine	Diarrhea		
Zidovudine [†]	Neuropathy, pancreatitis, myopathy, xerostomia		
NON-NUCLEOSIDE REVERSE TRANSCRIPTASE INHIBITORS (NNRTIS)			
Delavirdine	Dizziness, insomnia, dyslipidemia	Midazolam	The most important negative adverse effects are neuropsychiatric events, skin reactions, GI alterations, and liver alterations.
Efavirenz	Confusion, agitation	Triazolam	
Etravirine	Rash, nausea	Clarithromycin	
Nevirapine	Hallucinations, depression, mania	Clarithromycin (rash, <drug concentration)	
	Skin rashes, nausea, vomiting	Sertraline (<drug concentration)	
	Diarrhea	Warfarin (>drug effect)	
	Stevens-Johnson syndrome, xerostomia, taste alteration	Ketoconazole (<drug concentration)	
NUCLEOTIDES			
Adefovir	Dizziness	NSAIDs, acyclovir, and ganciclovir affect the metabolism of tenofovir. Vancomycin, NSAIDs, and cyclosporine increase the risk for kidney disease.	Adefovir is not used often because of GI and renal toxicity. Tenofovir is used in patients on multiple-drug therapy who are not responding. Tenofovir usually is well tolerated.
Tenofovir	Nausea, diarrhea, weakness, depression, anxiety, skin rash—allergy, neuropathy, liver, kidney failure, lactic acidosis (rapid breathing, drowsiness, muscle aches)		
ENTRY INHIBITORS			
Enfuvirtide	Bacterial pneumonia, rash, fever, nausea, vomiting, glomerulonephritis, Guillain-Barré syndrome, taste disturbance, hyperglycemia, myalgia, xerostomia, anorexia	No significant drug interactions	Inhibits fusion of HIV-1 and CD4+ T cells. Only one fusion inhibitor has been approved (enfuvirtide), and it has to be injected.
Maraviroc	Liver	None	Three other entry inhibitors are available.
IMMUNE-BASED THERAPIES[‡]			
Chloroquine, hydroxychloroquine	Stomach upset, muscle weakness, retinopathy	Gold salts	These drugs reduce cellular activation, thus reducing HIV replication, and boost the immune response. Several others are in testing.
Interleukin-2	Fever, chills, nausea, vomiting	Pain medications, steroids	
Interleukin-7	Transient elevations of liver function tests	None yet reported.	

*Available in combination as Kaletra.

[†]Available in combination as Combivir, Epzicom, Trizivir, and Truvada.[‡]Although not antiretroviral therapy (ART) drugs, immune-based therapies also are being used in the management of human immunodeficiency virus (HIV) infection. ART is associated with many drug interactions; only a few are listed. For more detailed recommendations, see guidelines at <http://aidsinfo.nih.gov/guidelines>.

GI, Gastrointestinal; NSAID, nonsteroidal antiinflammatory drug.

BOX 18.3 Typical Antiretroviral Drug Regimens

Number of Antiretroviral Drugs

- A two-drug regimen is effective, but three drugs are preferred; 28 days of treatment is recommended.

Preferred Antiretroviral Regimen

- TDF + 3TC (or FTC) as the first two drugs
- LPV/r or ATV/r is the preferred third drug, but RAL, DRV/r, or EFV are alternatives.

ATV, Atazanir; DRV, darunavir; EFV, efavirenz; FTC, emtricitabine; HIV, human immunodeficiency virus; LPV, lopinavir; /r, boosted with ritonavir; RAL, raltegravir; TDF, tenofovir; 3TC, lamivudine.

emtricitabine.^{4,18-22} Several alternative drug regimens also appear in recent Department of Health and Human Services guidelines; however, no regimen has proved superior to efavirenz-based regimens with respect to virologic responses.^{4,18-22} Patients who respond to therapy generally show an increase in CD4+ count in the range of 50 to 150 cells/ μ L per year and viral loads of less than 75 copies/mL.^{4,18-22} Virologic suppression is defined as less than 48 copies/mL, and virologic failure is defined as a confirmed viral load of greater than 200 copies/mL in the presence of ART.^{4,18-22}

Patients who are taking ART medications must be closely monitored for drug effectiveness (which often wanes over time), development of antiviral resistance, drug toxicity, and drug interactions. Some important toxicities include hyperlactemia, mitochondrial dysfunction, peripheral neuropathy, hepatotoxicity, and lipodystrophy. Compliance also is a major challenge for patients in view of recognized drug toxicities, costs, and inconvenience.^{4,18-22} To this end, several drugs are now formulated as combination agents to simplify and improve treatment of the disease. Atripla, Epzicom, and Trizivir are combinations of three antiretrovirals, and Combivir, Epzicom, Trizivir, and Truvada are combinations of two nucleoside-nucleotide reverse transcriptase inhibitors. Only a decade ago, when cocktails of AIDS drugs began to be used, patients sometimes had to take two dozen or more pills a day. Currently, immune modulators and stem cell therapies also are being tested in conjunction with ART.²³

In about 25% of patients, particularly those with very low CD4+ T cell counts, weeks after initiation of ART, an exacerbation of preexisting opportunistic infections occurs.²⁰ This condition, known as *immune reconstitution inflammatory syndrome* (IRIS), probably results from elicitation of an inflammatory response in association with the antiviral drugs, leading to focal lymphadenitis and reactivation of a viral disease (e.g., shingles) or granulomatous infection.^{20,24}

Chemoprophylaxis

Chemoprophylaxis regimens are recommended when CD4+ lymphocyte counts drop to specific levels to prevent initial

episode of a disease or to suppress a developing opportunistic infection. These regimens exist for the prevention of *Pneumocystis* pneumonia, tuberculosis, toxoplasmosis, and other opportunistic diseases.^{4,25-27} Also, select vaccines are recommended for HIV-infected adults before the CD4+ T cell count drops to below 200/ μ L. Standard resources such as the NIH's AIDS information website (<http://www.aids.info.nih.gov>) are available for more information on this topic.

Hope exists for improving outcomes with HIV infection. Vaccine development is ongoing, and stem cell transplantation with CCR5-deficient cells has led to reduction of the HIV viral reservoir in one patient and may prove effective in eradicating HIV in the clinical setting.^{4,25-27}

DENTAL MANAGEMENT

Health history, head and neck examination, intraoral soft tissue examination, and complete periodontal and dental examinations should be performed on all new patients. History and clinical findings may indicate that the patient has HIV infection or AIDS. Of note, however, is that patients who know they are seropositive and those at high risk for these conditions may not answer questions honestly on account of the stigma or concern for privacy. Accordingly, the patient history should be obtained whenever possible with this understanding; verbal communication in a quiet, private location; and the sharing of knowledge and facts in an atmosphere of honesty and openness.^{28,29}

Patients who, on the basis of history or clinical findings, are found to be at high risk for AIDS or related conditions should be referred for HIV testing and medical evaluation. The dentist can undertake diagnostic laboratory screening using saliva (OraQuick Advance; OraSure Technologies, Bethlehem, PA), or serum testing can be done with a referral to a medical facility. Discussions with the patient should emphasize importance of testing and should ascertain risk factors, including sexual habits, intravenous drug use, and so forth. Patients with high-risk factors should be strongly encouraged to seek diagnostic testing.²⁵⁻²⁹

Patients at high risk for AIDS and those in whom AIDS or HIV has been diagnosed should be treated in a manner identical to that for any other patient—that is, with standard precautions. Several guidelines have emerged regarding the rights of dentists and patients with AIDS, including the following:

- Dental treatment may not be withheld if the patient refuses to undergo testing for HIV exposure. The dentist may then assume that the patient is a potential carrier of HIV and should treat the person using standard precautions, just as for any other patient.
- A patient with AIDS who needs emergency dental treatment may not be refused care simply because the dentist does not want to treat patients with AIDS.

- No medical or scientific reason exists to justify why patients with AIDS who seek routine dental care may be declined treatment by the dentist, regardless of the practitioner's personal reason. However, if the dentist and the patient agree, the dentist may refer the patient to another provider who is more willing or better suited (in keeping with the patient's oral health status) to provide treatment.
- A patient who has been under the care of a dentist and then develops AIDS or a related condition must be treated by that dentist or receive a referral that is satisfactory for and agreed to by the patient.
- The CDC and the American Dental Association recommend that infected dentists inform their patients of their HIV serostatus and should receive consent or refrain from performing invasive procedures.³⁰

Treatment Planning Considerations

A major consideration in dental treatment of the patient with HIV infection/AIDS involves determining the current CD4+ lymphocyte count and level of immunosuppression of the patient.⁴ Another point of emphasis in dental treatment planning is the level of viral load, which may be related to susceptibility to opportunistic infections and rate of progression of AIDS.³¹ The dentist should be knowledgeable about the presence and status of opportunistic infections and the medications that the patient may be taking for therapy or prophylaxis for such conditions. Patients who have been exposed to the AIDS virus and are HIV seropositive but asymptomatic may receive all indicated dental treatment. Generally, this is true for patients with a CD4+ cell count of more than 350/ μ L. Patients who are symptomatic for the early stages of AIDS (i.e., CD4+ cell count <200/ μ L) have increased susceptibility to opportunistic infections and may be medicated with prophylactic drugs.^{18,31}

Patients with AIDS can receive almost any dental care needed and desired after the possibility of significant immunosuppression, neutropenia, or thrombocytopenia has been ruled out. Complex treatment plans should not be undertaken before an honest and open discussion about the long-term prognosis of the patient's medical condition has occurred.

Dental treatment of HIV-infected patients without symptoms is no different from that provided for any other patient in the practice.³¹ Standard precautions must be used for *all* patients. Any oral lesions found should be diagnosed and then managed by appropriate local and systemic treatment or referred for diagnosis and treatment. Patients with lesions suggestive of HIV infection must be evaluated for possible HIV.³²

In planning invasive dental procedures, attention must be paid to the prevention of infection and excessive bleeding in patients with severe immunosuppression, neutropenia, and thrombocytopenia. This may involve the use of prophylactic antibiotics in patients with CD4+ cell counts below 200/ μ L or severe neutropenia (neutrophil

count <500/ μ L).³² White blood cell (WBC) and differential counts, as well as a platelet count, should be ordered before any surgical procedure is undertaken. Patients with severe thrombocytopenia may require special measures (platelet replacement) before surgical procedures (including scaling and curettage) are performed. Medical consultation should precede any dental treatment for patients with these abnormalities.³²

Patients may be medicated with drugs that are prophylactic for *Pneumocystis* pneumonia, candidiasis, herpes simplex virus (HSV) or CMV infection, or other opportunistic disease, and these medications must be carefully considered in dental treatment planning. Care in prescribing other medications must be exercised with these, or any, medications after which the patient may experience adverse drug effects, including allergic reactions, toxic drug reactions, hepatotoxicity, immunosuppression, anemia, serious drug interactions, and other potential problems. Most often, consultation with the patient's physician is beneficial.³² For example, acetaminophen should be used with caution in patients treated with zidovudine (Retrovir) because studies have suggested that granulocytopenia and anemia, associated with zidovudine, may be intensified; also, aspirin should not be given to patients with thrombocytopenia. Meperidine should be avoided in patients taking ritonavir because ritonavir increases the metabolism of meperidine to normeperidine, which is associated with adverse effects such as lethargy, agitation, and seizures. Propoxyphene levels may be increased by ritonavir, which may potentially lead to toxic effects such as drowsiness, slurred speech, or incoordination. Antacids, phenytoin, cimetidine, and rifampin should not be given to patients who are being treated with ketoconazole because of the possibility of altered absorption and metabolism. Also, midazolam and triazolam should be avoided in patients taking select protease inhibitors because benzodiazepine metabolism may be inhibited, leading to excessive sedation or respiratory depression.³²

Medical consultation is necessary for symptomatic HIV-infected patients before surgical procedures are performed. The patient's current platelet count and WBC count should be available. Patients with abnormal test results may require special management. All of these matters must be discussed in detail with the patient's physician. Any source of oral or dental infection should be eliminated in HIV-infected patients, who often require more frequent recall appointments for maintenance of periodontal health. Daily use of chlorhexidine mouth rinse may be helpful.

In patients with periodontal disease whose general health status is not clear, periodontal scaling for several teeth can be provided to allow assessment of tissue response and bleeding. If no problems are noted, the rest of the mouth can be treated. Adjunctive antibacterial measures may be required if the patient's CD4+ cell count is below 200/ μ L or if tissues remain unresponsive to

routine therapy. Root canal therapy has good success in patients with HIV infection, and no modifications are required. Infection can be treated through local and systemic measures.³²

Occupational Exposure to HIV

The risk of HIV transmission from infected patients to health care workers is very low, reportedly about 3 of every 1000 cases (0.3%) in which a needlestick or other sharp instrument transmitted blood from a patient to a health care worker.³⁴ In comparison, the risk of infection from a needlestick is 3% for hepatitis C and is 30% for hepatitis B.

After a needlestick, the rate of transmission of HIV can be reduced by postexposure prophylaxis (PEP).³³ The CDC recommends PEP as soon as possible after exposure to HIV-infected blood.²⁹ The number of PEP drugs recommended is based on the severity of the exposure as well as the HIV status of the source patient.³³ A less severe exposure (solid needle or superficial injury) from a source patient who is asymptomatic or has a low viral load (<1500 viral copies/mL) has a two-drug PEP. Use of at least a three-drug PEP regimen is recommended for more severe exposure (large-bore hollow needle, deep puncture, visible blood on device or needle used in patient's artery or vein) or when the patient is symptomatic, has AIDS, or a high viral load. The recommended basic regimen for HIV PEP is tenofovir plus emtricitabine or zidovudine plus lamivudine.³³ The expanded regimen includes a standard two-drug regimen plus a protease inhibitor such as ritonavir-boosted (*r*) lopinavir, darunavir/*r*, atazanavir/*r*, or raltegravir. PEP should be continued for 4 weeks, during which time the exposed clinician should be provided expert consultation and follow-up monitoring for compliance, adverse events, and possible seroconversion. Tests for seroconversion should be performed at 3, 6, and 12 months. To date, there have been six reports of occupational HIV seroconversion despite combination PEP.³³

If the exposed dental health care worker is pregnant, the risk of infection versus unknown yet possible risks of PEP to the fetus should be discussed.

Risk of Transmission From Health Care Personnel

The risk of transmission in the dental setting is minimized by adherence to standard infection control procedures.^{32,33}

Oral Complications and Manifestations

Oral lesions can be one of the early signs of HIV infection and risk for progression to AIDS and occur commonly (30%–80%) in infected patients.^{35,36} Currently, patients with HIV/AIDS that is being treated can live comfortable lives with few complications for many years.³⁴⁻³⁸ For these reasons, the clinician should be cognizant of the oral manifestations of HIV infection and AIDS. The overall prevalence of oral manifestations has changed significantly since the advent of HAART (\approx 10%).³⁴⁻³⁸ The more serious oral conditions have diminished.³⁴⁻³⁸ Common oral

manifestations include candidiasis (erythematous or pseudomembranous) of the oral mucosa (Figs. 18.4 to 18.7), bluish purple or red lesion(s) that on biopsy are identified as Kaposi sarcoma (Figs. 18.8 to 18.11), and hairy leukoplakia of the lateral borders of the tongue (Fig. 18.12).³⁴⁻³⁹ Other oral conditions that occur in association with HIV infection are HSV, CMV, Epstein-Barr virus (EBV), herpes zoster, deep tissue infections (e.g., cryptococcus, histoplasmosis), recurrent aphthous ulcerations, linear gingival erythema (Fig. 18.13), necrotizing ulcerative periodontitis (Fig. 18.14), necrotizing stomatitis, tuberculosis, syphilis, oral warts (human papillomavirus, condyloma acuminatum; Fig. 18.15), facial palsy, trigeminal neuropathy, salivary gland enlargement, xerostomia, and melanotic pigmentation.³⁴⁻³⁹ Candidiasis, hairy leukoplakia, specific forms of periodontal disease



FIG 18.4 White lesions on the palate in a patient with AIDS. The lesions could be scraped off with a tongue blade. The underlying mucosa was erythematous. Clinical and cytologic findings supported the diagnosis of pseudomembranous candidiasis. (From Silverman S Jr: *Color atlas of oral manifestations of AIDS*, ed 2, St. Louis, 1996, Mosby.)



FIG 18.5 Note the white lesions on the oral mucosa. The diagnosis of pseudomembranous candidiasis was established. (Courtesy of Eric Haus, Chicago, IL.)

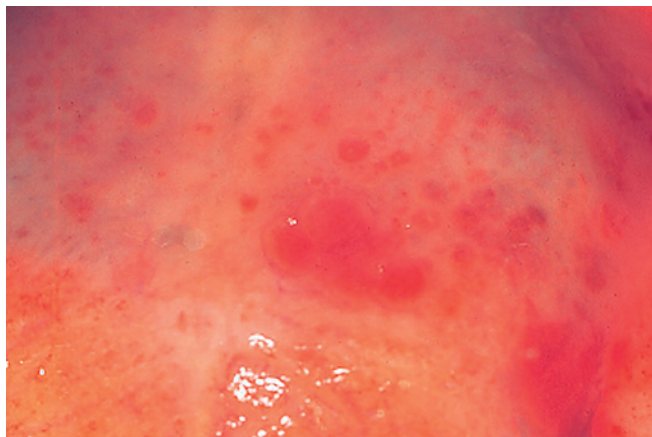

FIG 18.6 Erythematous palatal lesion in an HIV antibody–positive patient. Smears taken from the lesion showed hyphae and spores consistent with *Candida*. The lesion healed after a 2-week course of antifungal medications. A diagnosis of erythematous candidiasis was made on the basis of clinical laboratory findings. (Courtesy of Eric Haus, Chicago, IL.)

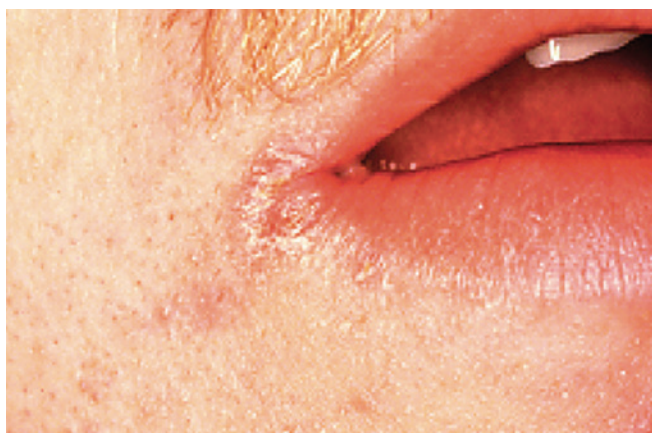

FIG 18.7 Angular cheilitis in a patient with AIDS. The lesion responded to antifungal medication. (Courtesy of Eric Haus, Chicago, IL.)

(i.e., linear gingival erythema and necrotizing ulcerative periodontitis), Kaposi sarcoma, and non-Hodgkin lymphoma are reported to be strongly associated with HIV infection.³⁴⁻³⁹ Likewise as the condition progresses, these conditions become more prevalent and more severe.³⁴⁻³⁹ Features and management of the oral manifestations of HIV infection are discussed in [Tables 18.5](#) and [18.6](#). In addition, clinicians should be aware that oral lesions can be a feature of the stage of the disease or a sign of treatment failure or disease progression.³⁴⁻³⁹

Worldwide, candidiasis is the most common oral manifestation of HIV infection.^{35,36} Oral candidiasis diagnosed in HIV-infected patients with persistent generalized lymphadenopathy may be of predictive value for the subsequent development of AIDS. The appearance of pseudomembranous candidiasis in HIV-infected persons has been shown to be a strong indicator for progression



FIG 18.8 Multiple erythematous lesions on the face of a patient with AIDS. With the use of biopsy, lesions were established as Kaposi sarcoma. (Courtesy of Sol Silverman, San Francisco, CA.)



FIG 18.9 Multiple large, flat, erythematous lesions involving the palatal mucosa. Biopsy revealed the lesions to be Kaposi sarcoma, and the patient was eventually given a diagnosis of AIDS. (Courtesy of Sol Silverman, San Francisco, CA.)

of infection to AIDS. The erythematous form of candidiasis also indicates progression toward AIDS.³⁴⁻³⁹ This information might be helpful to dental clinicians in evaluating patients for the initial diagnosis of HIV/AIDS or in determining stage of infection and level of immunosuppression. However, the oral manifestations of candidiasis

Text continued on p. 328

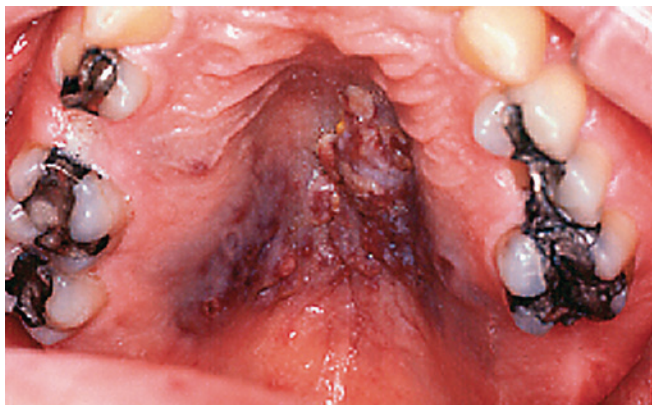

FIG 18.10 Palatal lesion in a patient with AIDS. Biopsy revealed Kaposi sarcoma. (Courtesy of Sol Silverman, San Francisco, CA.)



FIG 18.11 Kaposi sarcoma of the gingiva. (From Silverman S Jr: *Color atlas of oral manifestations of AIDS*, ed 2, St. Louis, 1996, Mosby.)



FIG 18.12 Diffuse white lesion involving the tongue. Biopsy supported the diagnosis of hairy leukoplakia. (From Silverman S Jr: *Color atlas of oral manifestations of AIDS*, ed 2, St. Louis, 1996, Mosby.)



FIG 18.13 Band of linear gingival erythema involving the free gingival margin of a human immunodeficiency virus-infected patient. (From Neville B, Damm D, Allen C: *Oral and maxillofacial pathology*, ed 3, St. Louis, 2009, Saunders.)



FIG 18.14 Necrotizing ulcerative periodontitis in a human immunodeficiency virus-infected patient. The diagnosis was established after the patient was referred for medical evaluation. (Courtesy of Sol Silverman, San Francisco, CA.)



FIG 18.15 Multiple areas of condylomata acuminata on the gingivae of an HIV-positive patient. (From Silverman S Jr: *Color atlas of oral manifestations of AIDS*, ed 2, St. Louis, 1996, Mosby.)

TABLE 18.5 Head, Neck, and Oral Lesions Commonly Associated With HIV Infection and AIDS

Oral Condition	Comments	Treatment
Persistent generalized lymphadenopathy	An early sign of HIV infection found in about 70% of infected patients during the latent stage of infection Must be present >3 months and in two or more extralingual locations Anterior and posterior cervical, submandibular, occipital, and axillary nodes are most frequently involved.	Usually not treated directly; may need biopsy to rule out lymphoma or other conditions
Oral candidiasis Pseudomembranous Erythematous Hyperplastic Angular cheilitis	Most common intraoral manifestation of HIV infection. First found during the early symptomatic stage of infection. This indicates that AIDS will develop within 2 years in untreated patients. ≈90% of patients with AIDS will develop oral candidiasis at some time during their disease course.	Nystatin often is ineffective. Topical clotrimazole is effective but has high rate of recurrence. Systemic fluconazole and itraconazole are effective but have a number of drug interactions and may result in drug-resistant candidiasis. If azoles fail, then IV amphotericin B can be administered.
HIV-associated periodontal disease Linear gingival erythema (LGE)	LGE does not respond to improved plaque control procedures. Condition is associated with candidiasis.	LGE usually responds to plaque removal, improved oral hygiene, and chlorhexidine rinses. Persistent cases usually respond to local measures plus systemic antifungal medications.
Necrotizing ulcerative gingivitis (NUG) ¹⁶	NUG relates to ulceration and necrosis of one or more interdental papillae with no loss of periodontal attachment.	Therapy for NUG, NUP, and NS involves debridement (removal of necrotic tissue and povidone-iodine irrigation), chlorhexidine rinses, metronidazole, follow-up care, and long-term maintenance.
Necrotizing ulcerative periodontitis (NUP)	NUP consists of gingival ulceration and necrosis with attachment loss and does not respond to conventional periodontal therapy.	
Necrotizing stomatitis (NS)	May be seen as an extension of NUP or may involve oral mucosa separate from the gingiva	
Herpes simplex virus (HSV) infection	Immunocompetent persons and HIV-infected patients experience about the same rate of recurrent HSV infection (10%–15%), but in HIV-infected patients, the lesions are more widespread, occur in an atypical pattern, and may persist for months.	Systemic acyclovir, valacyclovir, or famciclovir for at least 5 days can be effective. Higher doses may be needed during severe immunosuppression. An elixir or syrup of diphenhydramine (Benadryl) of 12.5 mg/5 mL can be used for pain control.
Varicella-zoster virus (VZV) infection	Recurrent VZV infection is common in HIV-infected patients, but the course is more severe. Intraoral lesions are often severe and can lead to bone involvement with loss of teeth.	Valacyclovir 1 g PO tid; famciclovir 500 mg PO tid; acyclovir 800 mg PO 5 times per day. IV acyclovir may be needed for severe herpes zoster in patients with immunosuppression.
Oral hairy leukoplakia (OHL)	White lesion most often found on the lateral border of the tongue. OHL on rare occasions has been found on the buccal mucosa, soft palate, and pharynx. Associated with EBV infection In an untreated patient with HIV symptomatic infection, the finding of OHL indicates that AIDS will develop in the near future.	Treatment often is not needed. Acyclovir or Desiclovir can result in rapid resolution, but recurrence is likely. Retinoids or podophyllum resin therapy can lead to temporary remission. HIV therapy with ART can result in significant regression.
Kaposi sarcoma (KS)	HHV-8 is involved in KS development. ≈50% of patients with KS have oral lesions, and the oral cavity is the initial site of involvement in 20% to 25% of cases. The most common sites are the hard palate, gingival, and tongue. KS that occurs in an HIV-infected patient is diagnostic of AIDS.	Often regresses with HAART. Treatment involves irradiation and local and systemic chemotherapy. Focal symptomatic lesions can be excised or injected with vinblastine or a sclerosing agent (sodium tetradecyl sulfate). Other options for dealing with these types of lesions are cryotherapy, laser ablation, and electrosurgery, but care must be taken to protect operating personnel from aerosolization of viral particles when the laser or electrosurgery unit is used.

AIDS, Acquired immunodeficiency syndrome; *ART*, antiretroviral therapy; *EBV*, Epstein-Barr virus; *HAART*, highly active antiretroviral therapy; *HHV-8*, human herpes virus type 8; *HIV*, human immunodeficiency virus; *IV*, intravenous; *PO*, oral; *tid*, three times a day.

TABLE 18.6 Less Common Oral Conditions Associated With HIV Infection

Oral Condition	Comments	Treatment
Aphthous stomatitis Minor Major Herpetiform	≈66% of lesions are of the more uncommon forms—major and herpetiform. With more severe reduction of CD4+ cell count, major lesions become more prevalent. Lesions that are chronic or atypical or that do not respond to treatment should be biopsied.	Treatment of major lesions that persist involves potent topical or intralesional corticosteroids. Systemic steroids generally are avoided to prevent further immunosuppression. Thalidomide treatment has yielded good response but should be used for only a short time because the drug can enhance HIV replication. Granulocyte colony-stimulating factor has produced significant improvement in a limited number of patients.
Human papillomavirus (HPV) Verruca vulgaris (wart) Oral squamous papilloma	The usual HPV types are found in oral lesions, but some uncommon variants such as HPV-7 and HPV-32 also are found. Lesions usually are multiple and may be found on any oral mucosal site.	Treatment of choice is surgical removal of the lesion(s). Other treatment modalities include topical podophyllin, interferon, and cryosurgery. Laser ablation and electrocoagulation have been used, but care must be taken because the plume may contain infectious HPV.
Histoplasmosis	Histoplasmosis is the most common endemic respiratory fungal infection in the United States and usually is subclinical and self-limiting. Dissemination of infection occurs in ≈5% of patients with AIDS who live in areas in the United States where the fungus is endemic.	The treatment of choice for disseminated histoplasmosis is IV amphotericin B. Oral itraconazole also has been found to be effective and has fewer adverse effects, with better patient compliance.
Molluscum contagiosum	Molluscum contagiosum is caused by a poxvirus. The lesions are small papules with a central depressed crater. In immunocompetent persons, the lesions are self-limiting and are found on the genitals and trunk. In patients with AIDS, multiple lesions (hundreds) are found that do not regress (5%–10% of patients with lesions have lesions of the facial skin).	Curettage, cryosurgery, and cautery have been used to treat these lesions, but they are painful, and recurrences are common. Resolution of multiple lesions has been reported with HAART.
Thrombocytopenia	Thrombocytopenia is found in ≈10% of HIV-infected patients. It may occur during any stage of the disease. Skin manifestations are most common, but petechiae, ecchymosis, and spontaneous gingival bleeding can occur in the oral cavity.	Platelet counts <50,000/mm ³ may result in significant bleeding with minor surgical procedures. Platelet replacement may be indicated for these patients.
HIV-associated salivary gland disease	Found in 5% of HIV-infected patients and can occur any time during the infection. Bilateral swelling of the parotid gland is most common. In some patients, CD8+ lymphocytes infiltrate the gland and are associated with lymphadenopathy. Xerostomia may occur. Patients are at increased risk for B-cell lymphoma.	Risk is increased for cysts of the parotid and lymphoma. Treatment involves antiretroviral therapy ± immune modulators. Associated xerostomia can be managed with sialogogues and saliva substitutes.
Hyperpigmentation	Melanin pigmentation has been reported to occur in HIV-infected patients. Several of the medications (ketoconazole, clofazimine, and zidovudine) used to treat these patients may cause melanin pigmentation. Addison-like pigmentation also may occur because of destruction of the adrenal gland. HIV infection itself may cause melanin pigmentation.	Usually no treatment is indicated. Single lesions may have to be biopsied so that melanoma can be ruled out. Patients with Addison disease may require corticosteroids.

TABLE 18.6 Less Common Oral Conditions Associated With HIV Infection—cont'd

Oral Condition	Comments	Treatment
Lymphoma	Found in ≈3% of patients with AIDS. Most are found in extranodal locations. Most lesions are non-Hodgkin B-cell lymphoma and are related to EBV. The CNS is the most common site, but oral lesions occur in the palate and gingiva and in other locations.	Treatment usually involves a combination of chemotherapy and radiation and is used for local control of disease. The prognosis is very poor, with death occurring within months of the diagnosis. HAART has reduced the prevalence of opportunistic infections and KS in HIV-infected patients but has not affected the prevalence of lymphoma.
Oral squamous cell carcinoma (SCC)	Can be found in the oral cavity, pharynx, and larynx in HIV-infected persons. The same risk factors apply as for the general population, but the cancer occurs at a younger age (it appears that HIV infection accelerates the onset of carcinoma).	Treatment of oral SCC is the same as for non-HIV-infected patients: surgery, irradiation, chemotherapy, or combination therapy.

AIDS, Acquired immunodeficiency virus; CNS, central nervous system; EBV, Epstein-Barr virus; HAART, highly active antiretroviral therapy; HIV, human immunodeficiency virus; IV, intravenous; KS, Kaposi sarcoma.

BOX 18.4 Dental Management Considerations in Patients With HIV Infection or AIDS

P		C	
Patient Evaluation and Risk Assessment (see Box 1.1)			
<ul style="list-style-type: none"> Evaluate and determine whether HIV infection exists. Obtain medical consultation if poorly controlled or undiagnosed problem or if uncertain. 		Chair position	No issues
		Cardiovascular	Confirm cardiovascular status. Some ART drugs can increase risk of cardiovascular disease.
Potential Issues and Factors of Concern		D	
A		Devices	No issues
Analgesics	Aspirin and other NSAID use can worsen bleeding in a patient who has thrombocytopenia. Avoid during thrombocytopenic episodes. Check drug interactions before use.	Drugs	There are many drug interactions and drug toxicities associated with ART. Clinicians are advised to check drug reference resources before prescribing medications to patients on ART to minimize drug interactions. Also, some ART drugs can cause mucosal eruptions (see Table 18.3).
Antibiotics	Prophylactic use not required unless severe immune neutropenia (<500 cells/ μ L) is present. Manage postoperative infections with usual antibiotic use. Check for drug interactions before use of antibiotics.	E	
Anesthesia	No issues	Equipment	No issues
Anxiety	No issues	Emergencies/urgencies	No issues
Allergy	No issues	F	
B		Follow-up	Routine and periodic follow-up evaluation is advised for patients in stage 1. Patients in stage 2 or 3 may require more frequent follow-up or additional prophylactic agents and may require hospital-like environment for care. Inspect for oral lesions to monitor for disease progression or ART treatment failure.
Bleeding	Excessive bleeding may occur in patients with untreated or poorly controlled disease as a result of thrombocytopenia, which fortunately is not a common finding.		
Breathing	Ensure that patient does not have a pulmonary infection. Delay treatment until pulmonary infections are resolved.		
Blood pressure	No issues		

ART, Antiretroviral therapy; NSAID, nonsteroidal antiinflammatory drug.

that occurred more recently may be masked by earlier use of prophylactic antifungal agents.³⁴⁻³⁹

Kaposi sarcoma is a malignant tumor of endothelial cells caused by human herpesvirus type 8 (HHV-8). MSM who are HIV-infected are more commonly affected.³⁴⁻³⁹ In these patients, Kaposi sarcoma most often is disseminated throughout the body and runs a fulminant clinical course. Before 1996, the survival rate was 35% at 2 years. However, survival rates have improved to 81% since the introduction of protease inhibitors into the ART regimen.³⁴⁻³⁹

Hairy leukoplakia is an asymptomatic, corrugated white lesion of the lateral borders of the tongue caused by reactivation and replication of EBV.³⁸ This lesion can appear in any patient who is immunosuppressed, regardless of HIV status. The diagnosis can be made on cell scrapings or from a biopsy. Histologic features include koilocytosis and hyperkeratotic, hairlike surface projections from the lesion. Treatment is with antiviral agents.³⁸

Lymphadenopathy at cervical and submandibular locations often is an early finding in patients infected with HIV. This condition is persistent and may be found in the absence of any current infection or medications known to cause lymph node enlargement. The nodes tend to be larger than 1 cm in diameter, and multiple sites of enlargement may be found.³⁴⁻³⁹

The overall general dental management of the patient with AIDS is summarized in **Box 18.4**. Dentists should perform head and neck and intraoral soft tissue examinations on all patients. White lesions in the mouth must be identified and appropriate steps taken to establish a diagnosis. This may involve cell study, culture, and biopsy by the dentist or referral to an oral surgeon. If red or purple lesions are found that cannot be explained by history (e.g., trauma, burn, chemical, physical) or proved by clinical observation (healing within 7–10 days), biopsy is indicated. Persistent lymphadenopathy must be investigated by referral for medical evaluation, diagnosis, and treatment.

REFERENCES

- Centers for Disease Control and Prevention. <https://www.cdc.gov/hiv/statistics/overview/ataglance.html>.
- Centers for Disease Control and Prevention. HIV Surveillance Report, 2015; vol. 26. <http://www.cdc.gov/hiv/library/reports/surveillance>.
- AIDS epidemic update, Geneva, WHO/UNAIDS, 2009; available at http://www.unaids.org/en/media/unaids/contentassets/dataimport/pub/report/2009/jc1700_epi_update_2009_en.pdf. Accessed on 31 March 2011.
- Blankston JN, Siliciano RF. Immunopathogenesis of human immunodeficiency virus infection. Chapter 386 in: Goldman L, Schafer AI, eds. *Cecil Textbook of Medicine*. 25 ed. Elsevier; 2016:1580-1590, ISBN 978-1-4377-1604-7.
- Del Rio C, Cohen MS. Prevention of human immunodeficiency virus infection. Chapter 387 in: Goldman L, Schafer AI, eds. *Cecil Textbook of Medicine*. 25 ed. Elsevier; 2016:1590-1612, ISBN 978-1-4377-1604-7.
- Campbell-Yesufu OT, Gandhi RT. Update on human immunodeficiency virus (HIV)-2 infection. *Clin Infect Dis*. 2011;52:780-787.
- Barré-Sinoussi F, Chermann JC, Rey F, et al. Isolation of a T-lymphotropic retrovirus from a patient at risk for acquired immune deficiency syndrome (AIDS). *Science*. 1983;220:868-871.
- Gallo RC, Salahuddin SZ, Popovic M, et al. Frequent detection and isolation of cytopathic retroviruses (HTLV-III) from patients with AIDS and at risk for AIDS. *Science*. 1984;224:500-503.
- Levy JA, Hoffman AD, Kramer SM, et al. Isolation of lymphocytotropic retroviruses from San Francisco patients with AIDS. *Science*. 1984;225:840-842.
- Hillis DM. AIDS. Origins of HIV. *Science*. 2000;288:1757-1759.
- Fauci AS, Lane HC. HIV disease: AIDS and related disorders. In: Fauci AS, et al, eds. *Harrison's Principles of Internal Medicine*. ed 17. New York: McGraw-Hill; 2008:1772-1776.
- Gaur AH, Dominguez KL, Kalish ML, et al. Practice of feeding pre-masticated food to infants: a potential risk factor for HIV transmission. *Pediatrics*. 2009;124:658-666.
- Abu-Raddad LJ, Magaret AS, Celum C, et al. Genital herpes has played a more important role than any other sexually transmitted infection in driving HIV prevalence in Africa. *PLoS One*. 2008;3:e2230.
- Workowski KA, Berman S. Sexually transmitted diseases treatment guidelines. *MMWR Recomm Rep*. 2010;59:1-110, 2010.
- Pedersen C, Lindhardt BO, Jensen BL, et al. Clinical course of primary HIV infection: consequences for subsequent course of infection. *BMJ*. 1989;299:154-157.
- Eshleman SH, Khaki L, Laeyendecker O, et al. Detection of individuals with acute HIV-1 infection using the ARCHITECT HIV Ag/Ab Combo assay. *J Acquir Immune Defic Syndr*. 2009;52:121-124.
- Stekler JD, Swenson PD, Coombs RW, et al. HIV testing in a high-incidence population: is antibody testing alone good enough? *Clin Infect Dis*. 2009;49:444-453.
- Guidelines for the use of antiretroviral agents in HIV-1-infected adults and adolescents, January 20, 2011. Developed by the DHHS Panel on Antiretroviral Guidelines for Adults and Adolescents—A Working Group of the Office of AIDS Research Advisory Council (OARAC) (publication online), <http://www.aidsinfo.nih.gov/ContentFiles/AdultandAdolescentGL.pdf>. Accessed on 31 March 2011.
- Pérez-Molina JA, Suárez-Lozano I, Del Arco A, et al. Gesida 5808 Study Group: Late initiation of HAART among HIV-infected patients in Spain is frequent and related to a higher rate of virological failure but not to immigrant status. *HIV Clin Trials*. 2011;12:1-8.
- Müller M, Wandel S, Colebunders R, et al. IeDEA Southern and Central Africa: Immune reconstitution inflammatory syndrome in patients starting antiretroviral therapy for HIV infection: a systematic review and meta-analysis. *Lancet Infect Dis*. 2010;10:251-261.

21. Treatment. Early ART reduces transmission, non-AIDS related health issues. *AIDS Policy Law*. 2015;30(10):1-4.
22. Lv R, Li G, Wu J, et al. Research on AIDS patients' survival time after highly active antiretroviral therapy, treatment effect and treatment modes. *Saudi Pharm J*. 2016;24(3):318-321.
23. Pernet O, Yadav SS, An DS. Stem cell-based therapies for HIV/AIDS. *Adv Drug Deliv Rev*. 2016;103(1):187-201.
24. <https://www.ncbi.nlm.nih.gov/nlmcatalog/101632792>. 2016.
25. Dale Sannisha K, Traeger L, O'Cleirigh C, et al. High prevalence of metabolic syndrome and cardiovascular disease risk among people with HIV on stable ART. *AIDS Patient Care STDS*. 2016;30(5):215-220. <https://doi.org/10.1089/apc.2015.0340>.
26. Muyanja D, Muzooru C, Musingo A, et al. High prevalence of metabolic syndrome and cardiovascular disease risk among people with HIV on stable ART in Southwestern Uganda. *AIDS Patient Care STDS*. 2016;30(1):4-10. doi:10.1089/apc.2015.0213.
27. Philbin MM, Parker CM, Parker RG, et al. The promise of pre-exposure prophylaxis for black men who have sex with men: an ecological approach to attitudes, beliefs, and barriers. *AIDS Patient Care STDS*. 2016;30(6):282-290. doi:10.1089/apc.2016.0037.
28. Campo J, Cano J, del Romero J, et al. Oral complication risks after invasive and non-invasive dental procedures in HIV-positive patients. *Oral Dis*. 2007;13:110-116.
29. Occupational postexposure prophylaxis for HIV: the PEpline perspective. *Top HIV Med*. 2010;18:174-177.
30. Oral Health Topics: HIV (serial online), <http://www.ada.org/5166.aspx?currentTab=1>. Accessed on 31 March 2011.
31. Patton LL, Shugars DC. Immunologic and viral markers of HIV-1 disease progression: implications for dentistry. *J Am Dent Assoc*. 1999;130:1313-1322.
32. Moswin AH, Epstein JB. Essential medical issues related to HIV in dentistry. *J Can Dent Assoc*. 2007;73:945-948.
33. Panlilio AL, Cardo DM, Grohskopf LA, et al. U.S. Public Health Service: Updated U.S. Public Health Service guidelines for the management of occupational exposures to HIV and recommendations for postexposure prophylaxis. *MMWR Recomm Rep*. 2005;54:1-17.
34. Hodgson TA, Greenspan D, Greenspan JS. Oral lesions of HIV disease and HAART in industrialized countries. *Adv Dent Res*. 2006;19:57-62.
35. Hirata CHW. Oral manifestations of AIDS. *Brazil J Otorhinolaryngol*. 2015;81(1):120-123.
36. Reznik D, O'Daniels C. Oral manifestations of AIDS in the HAART era. <http://www.hivdent.org/oralmanifestations/oralmanifestations.omhah0502.htm>.
37. Greenspan D, Canchola AJ, MacPhail LA, et al. Effect of highly active antiretroviral therapy on frequency of oral warts. *Lancet*. 2001;357(9266):1411-1412.
38. Greenspan JS, Greenspan D, Webster-Cyriaque J. Hairy leukoplakia; lessons learned: 30-plus years. *Oral Dis*. 2016;22 Suppl 1(1):120-127.
39. Lodi S, Guiguet M, Costagliola D, et al. CASCADE Collaboration: Kaposi sarcoma incidence and survival among HIV-infected homosexual men after HIV seroconversion. *J Natl Cancer Inst*. 2010;102:784-792.

Allergy

Allergic diseases are a spectrum of clinical disorders that result from immunologic reactions to a noninfectious foreign substance (antigen) in a sensitized host. Allergic reactions affect multiple organ systems by mobilizing cells and chemical mediators within the immune system. Allergic disorders are increasing in prevalence,¹ and this contributes significantly to increasing health care costs. An overview of the significant principles of allergic disease, including the various types of reactions that may be encountered in the dental office, is presented.

EPIDEMIOLOGY

Allergy is an abnormal or hypersensitive response of the immune system to a substance introduced into the body. It is estimated that more than 25% of all Americans demonstrate an allergy to some substance, including 10% to 20% who have allergic rhinoconjunctivitis, 7% who have a diagnosed food allergy, 7% who have asthma, 4% who are allergic to insect stings, and 5% who are allergic to one or more drugs.² Allergic reactions account for about 6% to 10% of all adverse drug reactions. Of these, 46% consist of erythema and rash, 23% urticaria, 10% fixed drug reactions, 5% erythema multiforme, and 1% anaphylaxis. About a 1% to 3% risk for an allergic reaction is associated with administration of any drug. Fatal drug reactions occur in about 0.01% of surgical inpatients and 0.1% of medical inpatients.^{1,3,4}

Drugs are the most common cause of urticarial reactions in adults, and food and infection are the most common causes of these reactions in children. Urticaria occurs in 15% to 20% of young adults. In approximately 70% of patients with chronic urticaria, an etiologic agent cannot be identified.^{1,3,4}

Anaphylaxis in dental practice is estimated to occur in 0.004 to 0.015 cases per dentist per year.⁵⁻⁷ One of the more common triggers is penicillin. About 10% of people who take penicillin develop an allergic reaction,⁸ and 0.04% to 0.2% of them experience anaphylaxis. Death occurs in about 1% to 10% of those persons who experience an anaphylactic reaction, and usually death occurs within 15 minutes after administration of the drug. Fifty percent of the time, the allergic reaction starts immediately after drug administration. About 70% of affected patients report that they have taken penicillin previously.⁹ The most common causes of anaphylactic

death are penicillin, bee stings, and wasp stings¹⁰; people with an atopic history are more susceptible to anaphylactic death than are patients with no history of allergy. Significant causes of anaphylaxis in clinical practice are listed in **Box 19.1**.^{1,3,4,11,12}

In rare cases, antihistamines have been reported to cause urticaria through an allergic response to the colored coating material of the capsule. In addition, azo and nonazo dyes used in toothpaste have been reported to cause anaphylactic-like reactions. Aniline dyes used to coat certain steroid tablets have caused serious allergic reactions as well.^{1,3,4}

Several drugs used in dentistry and medicine can cause allergic reactions. For example, parabens (used as preservatives in local anesthetics) have caused anaphylactoid reactions. Sulfites (sodium metabisulfite or acetone sodium bisulfite) used in local anesthetic solutions to prevent oxidation of the vasoconstrictors can cause serious allergic reactions. The group most susceptible to allergic reactions caused by sulfites includes the 25 million persons in the United States in whom asthma has been diagnosed.^{1,3,4} Allergy to latex occurs in between 1% and 6% of the general population and is much more common in persons who have spina bifida as well as health care personnel who wear latex gloves frequently.^{11,13,14} Also, use of iodinated organic compounds as radiographic contrast media results in laryngeal edema, seizure, or unconsciousness in about 3% of diagnostic procedures and between one and five deaths per million procedures.^{15,16}

ETIOLOGY

Allergic reactions classically involve contact with foreign substances, called *allergens* or *antigens*, that trigger hypersensitivity reactions, which involve elements of the innate, humoral and cellular immune system and the release of chemical mediators. The primary underlying factor is aberrant regulatory activity of T lymphocytes. The CD4+ T helper (T_h) cells, specifically the T_h2 lymphocytes, produce cytokines (interleukins-4, -13, and -5) that stimulate B-lymphocyte synthesis of IgE antibody and attract and activate eosinophils.¹⁷ The binding of IgE to mast cells and basophils leads to degranulation and release of additional vasoactive substances.¹⁸ Aspects of the innate, humoral, and cellular branches of the immune system and the four types of hypersensitivity reactions,

BOX 19.1 Causes of Human Anaphylactic Reactions of Importance in Health Care

Causative Agents

Antibiotics

- Penicillins, sulfonamides, vancomycin
- Amphotericin B, cephalosporins, nitrofurantoin
- Ciprofloxacin, tetracyclines, streptomycin, chloramphenicol

Miscellaneous Drugs and Therapeutic Agents

- Neuromuscular blocking agents (succinylcholine, d-tubocurarine)
- Antitoxins, progesterone, thiopental
- Vaccines, protamine sulfate, mechlorethamine
- Acetylsalicylic acid, NSAIDs, opiates

Diagnostic Agents

- Sodium dehydrocholate, radiographic contrast media
- Sulfobromophthalein, benzylpenicilloyl polylysine (Pre-Pen)

Hormones

- Insulin, parathormone, corticotropin
- Synthetic ACTH

Enzymes

- Streptokinase, penicillinase, chymotrypsin
- Asparaginase, trypsin, chymopapain

Blood Products

- Whole blood, plasma, gamma globulin
- Cryoprecipitate, IgA

Latex

ACTH, Adrenocorticotropic hormone; IgA, immunoglobulin A; NSAID, nonsteroidal antiinflammatory drug. Data from Grammer LC, Greenberger PA, editors: *Patterson's allergic diseases*, ed 7, Philadelphia, 2009, Lippincott Williams & Wilkins.

as originally described by Gell and Coombs,¹⁹ are shown in Fig. 19.1.

PATHOPHYSIOLOGY AND COMPLICATIONS

Humoral Immune System

B lymphocytes recognize specific foreign chemical configurations via receptors on their cell membranes. For the antigen to be recognized by specific B lymphocytes, it must first be processed by T lymphocytes and macrophages. Each clone (family) of B lymphocytes recognizes its own specific chemical structure. Once recognition has taken place, B lymphocytes differentiate and multiply, forming plasma cells and memory B lymphocytes. Memory B lymphocytes remain inactive until contact is made with the same type of antigen. This contact transforms the memory cell into a plasma cell that produces immunoglobulins (antibodies) specific for the antigen involved. Box 19.2 lists the functions of the five classes of immunoglobulins. Note that immunoglobulin E is the key

BOX 19.2 Functions of Immunoglobulins

- Immunoglobulin (Ig) G
 - Most abundant immunoglobulin
 - Small size allows diffusion into tissue spaces
 - Can cross the placenta
 - Opsonizing antibody—facilitates phagocytosis of microorganisms by neutrophils
 - Four subclasses: IgG1, IgG2, IgG3, IgG4 (IgG can bind to mast cells)
- IgA
 - Two types
 - Secretory (dimer, secretory components)—found in saliva, tears, and nasal mucus; secretory component protects from proteolysis
 - Serum (monomer)
 - Does not cross the placenta
 - Last immunoglobulin to appear in childhood
- IgM
 - Large molecule
 - Confined to intravascular space
 - First immunoglobulin produced
 - Activates complement
 - Good agglutinating antibody
- IgE
 - Very low concentration in serum (0.004%)
 - Increased in parasitic and atopic diseases
 - Binds to mast cells and basophils
 - Key antibody in pathogenesis of type I hypersensitivity reactions
- IgD
 - Low concentration in serum
 - Minor importance

Adapted from Thomson NC, Kirkwood EM, Lever RS, editors: *Handbook of clinical allergy*, Oxford, 1990, Blackwell Scientific, pp 1-36.

antibody involved in the pathogenesis of type I hypersensitivity reactions. Normal functions of the humoral immune system are shown in Box 19.3.^{1,3,4,11}

Type I, II, and III hypersensitivity reactions involve elements of the humoral immune system.

Type I Hypersensitivity. Type I hypersensitivity commonly involves contact with common exposures such as dust, mites, pollens, animal danders, food (e.g., shellfish, nuts, eggs, milk), drugs (e.g., antibiotics: sulfa drugs, penicillins, cephalosporins), or insect bites (e.g., bee stings). This is an IgE-mediated reaction that leads to the release of chemical mediators from mast cells and basophils in various target tissues, which leads to release of histamine, leukotrienes, and interleukins. These mediators cause vascular dilation and endothelial leakage and can induce smooth muscle contraction. In addition, these molecules attract CD4+ T lymphocytes, eosinophils, and basophils, which can extend the reaction time and alter healing. Usually type I reactions occur soon after second contact with an antigen; however, many people have repeated contacts with a specific drug or material before they become allergic to it (Fig. 19.2).^{1,3,4,11} Clinical

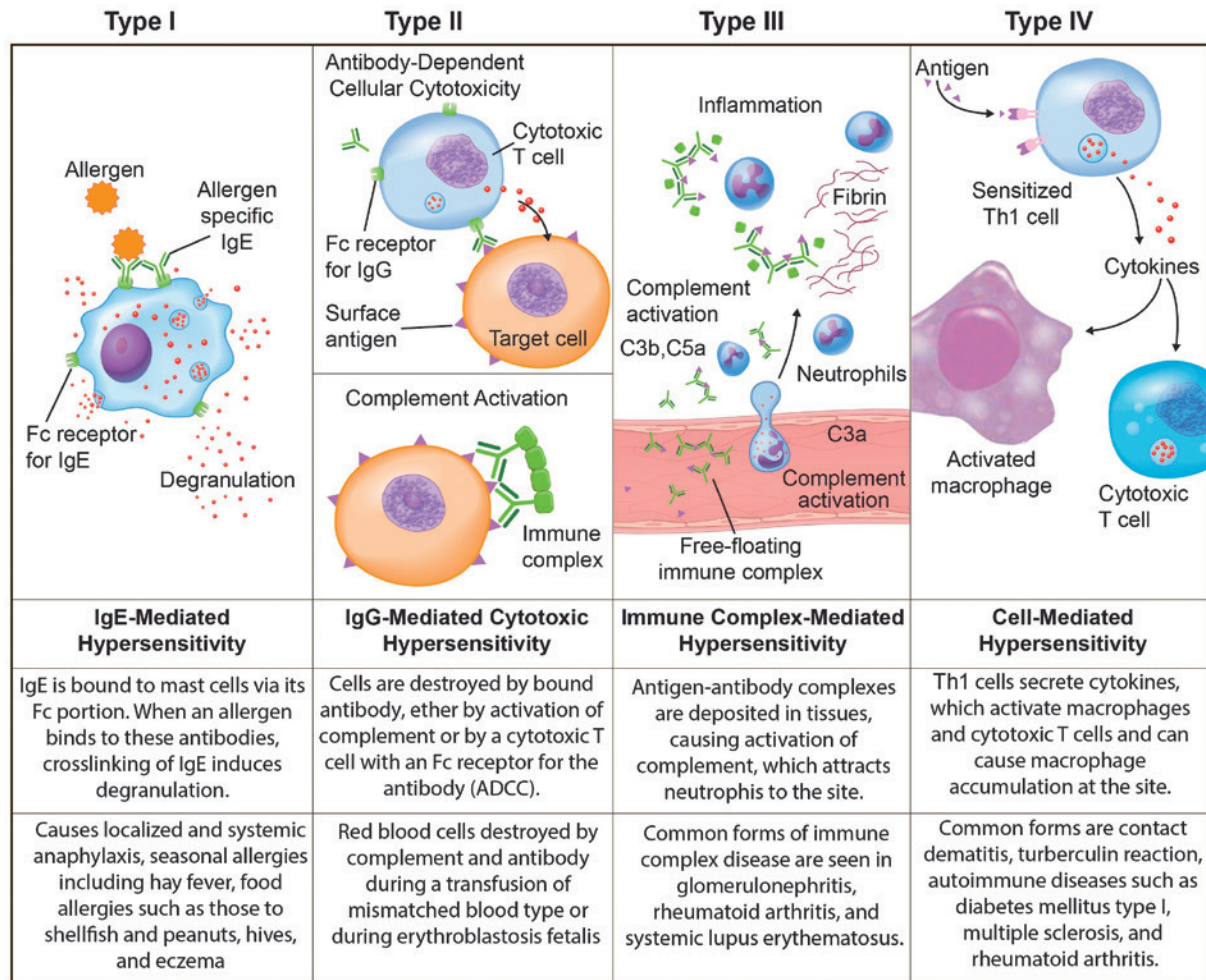

FIG 19.1 Four categories of hypersensitivity reactions.



FIG 19.2 This generalized urticarial reaction occurred after injection of penicillin for treatment of an acute oral infection. The patient had previously taken penicillin a number of times without any problem.

manifestations include hay fever, asthma, urticarial, angioedema, or anaphylaxis.

Anaphylaxis is an acute reaction involving the smooth muscle of the bronchi in which antigen-IgE antibody complexes form on the surface of mast cells, resulting in

sudden histamine release from these cells. The release of histamine, as well as other vasoactive mediators, leads to smooth muscle contraction and increased vascular permeability. The potential end result is acute respiratory compromise and cardiovascular collapse.

Atopy is a hypersensitivity state that is influenced by hereditary factors. Hay fever, asthma, urticaria, and angioedema are examples of atopic reactions. Lesions most commonly associated with atopic reactions include *urticaria*, which is a superficial lesion of the skin, and *angioedema*, which is edema that occurs in the deeper layers (i.e., dermis or subcutaneous tissues) and often involves diffuse enlargement of the lips, infraorbital tissues, larynx, or tongue. In true allergic reactions, these lesions result from the effects of antigens and their antibodies on mast cells in various locations in the body. As is typical for type I hypersensitivity, the antigen-antibody complex causes the release of mediators (histamine) from mast cells. These mediators then produce an increase in the permeability of adjacent vascular structures, resulting in loss of intravascular fluid into surrounding tissue spaces—this is seen clinically as urticaria, angioedema, and secretions associated with hay fever.^{1,3,4,11}

BOX 19.3 Functions of the Humoral Immune System

1. First encounter with antigen (primary response)
 - a. Latent period
 - Antigen is processed
 - B lymphocyte clone is selected
 - Differentiation and proliferation
 - Plasma cells produce specific immunoglobulins.
 - b. Specific immunoglobulin (Ig)M level increases first in serum followed by IgG.
 - c. IgM levels later fall to zero.
 - d. IgG levels fall; however, some stay the same.
2. Second encounter with antigen (secondary response)
 - a. Latent period is shorter
 - Antigen is processed
 - Memory cells are selected; become plasma cells
 - Plasma cells produce specific immunoglobulins.
 - b. IgM levels increase first.
 - c. IgG levels increase to 50 times the level found in the primary response.
 - d. IgM levels fall later.
 - e. IgG levels fall later, but a significant serum level is usually maintained.

Adapted from Thomson NC, Kirkwood EM, Lever RS, editors: *Handbook of clinical allergy*, Oxford, 1990, Blackwell Scientific, pp 1-36.

There are several types of angioedema and three types of interest to dentistry: acquired, drug induced, and hereditary angioedema. *Acquired angioedema* is allergic (histamine) based. *Drug-induced angioedema* results from impaired bradykinin degradation after administration of certain drugs, such as angiotensin-converting enzyme inhibitors. *Hereditary angioedema* is a rare genetic disorder caused by a deficiency or dysfunction of complement C1 esterase inhibitor, which can be triggered by stress, trauma (e.g., extractions, oral surgery), or infections. These triggers lead to activation of the complement cascade and Hageman factor (factor XII) and overproduction of bradykinin.^{11,20} The hereditary form can produce variable manifestations, including recurrent and sudden episodes of angioedema with swelling of the skin or mucosa of the extremities, oropharynx, or abdominal structures, the latter resulting in severe abdominal pain.

Type II Hypersensitivity. Type II hypersensitivity are IgG- or IgM-mediated reactions that result in destruction of the targeted cells by complement and antibodies. The classic example of type II (cytotoxic) hypersensitivity is transfusion reaction caused by mismatched blood.^{1,3,4,11}

Type III Hypersensitivity. Type III hypersensitivity, or *immune complex-mediated hypersensitivity*, occurs when there is excess antigen in the bloodstream. These antigens are bound with antibody, forming immune complexes of different size within blood vessels. The antigen-antibody complexes migrate under the basement membrane of small blood vessels, which sets off the complement cascade, particularly involving C3b and C5a. Macrophages remove

the large complexes, but the small complexes are ineffectively removed and accumulate in small blood vessels (capillaries and glomeruli) and in joints. This leads to an inflammatory response with key features of vasculitis, swelling, and pain. Clinical examples include serum sickness, vasculitis, systemic lupus erythematosus, and streptococcal glomerulonephritis.^{1,3,4,11}

Cellular Immune System

In the cellular or delayed immune system, T lymphocytes play the central role. The primary function of this system is to recognize and eradicate antigens that are fixed in tissues or within cells. This system is involved in protection against viruses, tuberculosis, and leprosy. Antibodies are not operative in the cell-mediated immune system; however, effector T lymphocytes produce various cytokines that serve as active agents of this system.^{1,3,4,11} For example, T_H1 lymphocytes can produce cytokines (IL-4, -5, -13) that stimulate B lymphocytes to produce IgE antibody.

Type IV Hypersensitivity. Type IV *delayed* hypersensitivity reactions involve the cellular immune system and cytokine release; they are not antibody mediated. Common conditions associated with type IV hypersensitivity are contact dermatitis, transplant rejection, and graft-versus-host disease. The sequential events involved in type IV hypersensitivity include dendritic cells and Langerhans cells that ingest a foreign antigen and present it to undifferentiated T lymphocytes. This response is mediated by sensitized CD4+ T lymphocytes, which release lymphokines (IL-2 and interferon gamma). The lymphokines promote a T_H1 reaction mediated by macrophages that begins in hours and peaks in 2 to 3 days, hence the term *delayed hypersensitivity*.

Some of the more common antigens that cause contact dermatitis include metal jewelry, perfumes, rubber products, chemicals such as formaldehyde, and medicines such as topical anesthetics.^{1,3,4,11} Contact allergy occurs when a substance of low molecular weight that is not antigenic by itself comes in contact with a tissue component (primarily a protein) and forms an antigenic complex. This small molecule is called a *hapten* (or one half of an antigen), and the resulting complex causes sensitization of T lymphocytes. Poison ivy is an example of a contact allergy wherein the reaction is delayed (with response occurring 48–72 hours after contact is made with the allergen).

Infectious-type allergic reactions are exemplified by the tuberculin skin test, in which a person who has previously been exposed to *Mycobacterium tuberculosis* develops a delayed response, usually within 48 to 72 hours after a second exposure to components of the bacteria. This response is characterized by induration, erythema, swelling, and sometimes ulceration at the site of injection.

Graft rejection occurs when organs or tissues from one body are transplanted into another body. Cellular rejection of transplanted tissue occurs unless the donor and recipient are genetically identical or the host immune

response has been suppressed. Graft-versus-host reaction is an unusual phenomenon that occurs in bone marrow transplant recipients whose cellular immune system has been rendered deficient by whole-body irradiation. Lymphocytes transferred to the host attempt to destroy host tissues.^{1,3,4,11}

Other examples of type IV hypersensitivity include diabetes type 1 in which pancreatic beta cells are attacked, the lymphocytic attack of oligodendrocyte proteins causing the demyelinated disease multiple sclerosis, and the lymphocytic infiltrate that occurs with Hashimoto thyroiditis.

Nonallergic Reactions or Pseudoallergy

Other agents may cause mast cells to release their mediators without inciting a true allergic reaction; this occurs in cases of chronic urticaria caused by certain drugs (e.g., meperidine), temperature changes, and emotional states and in some reactions to drugs. Most so-called anaphylactic reactions to local anesthetics do not involve an antigen-antibody reaction but result from damage to the mast cells caused by other mechanisms. These reactions are referred to as anaphylactoid or *anaphylaxis-like* reactions.^{1,3,4,11} From a clinical standpoint, approaches to management of patients with anaphylactic and anaphylactoid reactions are similar.

Nonallergic cases of urticaria, angioedema, and anaphylactoid reactions are caused by the nonspecific release of vasoactive amines from mast cells or by the activation of other forms of nonspecific immunologic effectors involving the complement system and Hageman factor-dependent pathway. One example is hereditary angioedema, in which tissue swelling is triggered by stress, trauma, or infections because of an underlying absence or dysfunction of C1 inhibitor, a protein that regulates the complement cascade pathway and the production of bradykinin. More in-depth discussion of the origin of these reactions can be found in standard texts on allergic diseases.^{1,3,4,20}

LABORATORY AND DIAGNOSTIC FINDINGS

Patients with IgE-mediated allergy can have elevated levels of total IgE, allergen-specific IgE, and eosinophils in their serum or nasal passages and test positive to a specific allergen after skin testing (patch or skin-prick testing) performed by an allergist. Tryptase blood tests are helpful in diagnosing anaphylaxis. Patients who have hereditary angioedema typically have low C4 levels and low levels of C1 inhibitor or low functional activity of C1 inhibitor and mutations in the C1-inhibitor/*SERPING1* gene as determined by genetic testing.

MEDICAL MANAGEMENT

Patients with atopy may be given injections to gradually desensitize them so that they are no longer allergic to the antigen. Some patients with severe asthma may be forced to move to an area of the country that does not contain

TABLE 19.1 Examples of Second- and Third-Generation Antihistamines

Drug	Trade Name(s)	OTC*
Acrivastine	Semprex, Benadryl Allergy Relief capsules	No
Cetirizine	Zyrtec	Yes
Desloratadine	Neoclaritin	No
Fexofenadine	Telfast 120, Telfast 180, Allegra	No
Levocetirizine	Xyzal	No
Loratadine	Claritin, Clarityn, Clarityne, Boots antihistamine tablets	Yes
Mizolastine	Mizollen, Mistamine (superseded by fexofenadine)	No
Rupatadine	Rupafin, Rupax, Ralif	No

*Some of these medicines can be purchased without a doctor's prescription in the United States.

OTC, Over the counter.

the antigen (e.g., in the case of allergy to pollen). Patients with asthma (see [Chapter 7](#)), immune complex injury, or cytotoxic immune reactions may be treated with systemic steroids, and those with hay fever or urticaria are treated with antihistamines.²¹

Newer antihistamines are highly effective and produce fewer adverse effects (e.g., drowsiness) than older antihistamines ([Table 19.1](#)). These agents differ in a number of ways, such as size of the tablets, duration of effect, efficacy, extent to which they can cause sleepiness (although all are superior to older antihistamines in this context), adverse effects, drug interactions, and price.

A variety of treatments, including topical steroids, have been used for patients with contact dermatitis. From a dental standpoint, a patient who is being treated for allergies has an increased chance of being allergic to another substance. In addition, if the person is taking steroids, the body's reaction to stress may be impaired (see [Chapter 15](#)).

DENTAL MANAGEMENT

Medical Considerations

Identification and Risk Assessment. Dentists are often confronted with problems related to allergy. One of the most common concerns is a patient who reports allergy to a local anesthetic, antibiotic, or analgesic. In this case, the history must be expanded, with specific efforts made to determine exactly what the offending substance was and exactly how the patient reacted to it. If the adverse reaction was of an allergic nature, one or more of the classic signs or symptoms of allergy should have been present ([Box 19.4](#)). If these signs or symptoms were not reported, the patient probably did not experience a true

BOX 19.4 Signs and Symptoms Suggestive of an Allergic Reaction

- Urticaria
- Swelling
- Skin rash
- Chest tightness
- Dyspnea, shortness of breath
- Rhinorrhea
- Conjunctivitis

BOX 19.5 Adverse Drug Reactions

Predictable

- Dose related
- No immunologic basis
- Account for about 80% of all adverse reactions to drugs
- Direct toxicity
- Overdose
- Drug interaction
- Adverse effects of drugs

Unpredictable

- Not dose related
- Unrelated to expected pharmacologic effects
- Allergy
- Pseudoallergy (anaphylactoid reactions)
- Idiosyncrasy
- Intolerance
- Paradoxical reactions (cause histamine release but not IgE-mediated)
- Underlying genetic defect often present

Data from Lichtenstein LM, Busse WW, Geha R, editors: *Current therapy in allergy, immunology, and rheumatology*, ed 6, St. Louis, 2004, Mosby.

allergic reaction. Dental providers should be aware that about 5% of self-reports of allergy are not true allergies.²² Common examples of reactions mislabeled as “allergy” are syncope after injection of a local anesthetic and nausea or vomiting after ingestion of codeine. Adverse drug reactions are listed in [Box 19.5](#).

Anesthetics. A common reaction to local anesthetics involves an anxious patient who, because of concern about receiving a “shot,” experiences a psychogenic reaction that includes hyperventilation, tachycardia, sweating, paleness, and syncope. True allergic reactions to the local anesthetics (amides) used in dentistry are rare.²³⁻²⁵

Local anesthetics containing a vasoconstrictor can cause an epinephrine reaction (tachycardia, sweating, paleness), which usually results from inadvertent intravenous injection ([Box 19.6](#)). Excessive amounts of an anesthetic also can cause a toxic reaction. Signs and symptoms associated with toxic reactions to a local anesthetic are talkativeness, slurred speech, dizziness, disorientation, euphoria, and nausea followed by muscle twitching or convulsions, mental and respiratory depression, unconsciousness, coma, and cardiovascular collapse.

BOX 19.6 Adverse Reactions to Local Anesthetics

- Allergic reaction
- Anxiety (syncope)
- CNS stimulation → CNS depression → Toxicity (talkativeness, excitement, euphoria; slurred speech, dizziness, depression, convulsions)
- Vasoconstrictor effects (heart palpitations)

CNS, Central nervous system.

Data from Malamed SF: Allergy and toxic reactions to local anesthetics, *Dent Today* 22:114-116, 118-121, 2003.

If the patient reports a toxic or vasoconstrictor reaction, the dentist should explain the likely cause of the previous reaction and should avoid injecting the local anesthetic solution intravenously by aspirating before injection and limiting the amount of solution to the recommended dose. If the patient’s history supports a fainting episode and not a toxic or allergic reaction, the dentist’s primary task is to reduce the patient’s anxiety before and during the dental visit. If the history supports a true allergic reaction to a local anesthetic, the dentist should try to identify the type of local anesthetic that was used. After this has been ascertained, a new anesthetic with a different basic chemical structure can be used. The two main groups of local anesthetics in dentistry consist of the following:

1. *Para*-aminobenzoic acid (PABA) esters (procaine [Novocain] and tetracaine [Pontocaine])
2. Amides (articaine [Septocaine], bupivacaine [Marcaine], lidocaine [Xylocaine], mepivacaine [Carbocaine], and prilocaine [Citanest])

The benzoic acid ester anesthetics may cross-react with each other, but amide anesthetics usually do not cross-react. Cross-reaction does not occur between ester and amide local anesthetics.^{23,26,27}

Procaine is the local anesthetic associated with the highest incidence of allergic reactions. Currently, it is available only in multidose vials. Its antigenic component appears to be PABA, one of the metabolic breakdown products of procaine. Cross-reactivity has been reported between lidocaine and procaine; however, this was traced to the presence of a germicide, methylparaben, which previously was used in small amounts as a preservative and is chemically similar to PABA. Methylparaben is no longer used as a preservative, so this problem is no longer a concern.²⁸ Lidocaine or another amide local anesthetic should be used for patients with a history of allergy to procaine.^{23,26,27}

Patients who have been allergic to local anesthetics but who cannot identify the specific agent to which they reacted present more of a diagnostic problem. The nature of the reaction must be established ([Box 19.7](#)), and if it is consistent with an allergic reaction, the next step should be to attempt to identify the anesthetic used. When the patient is unable to provide this information, the dentist

BOX 19.7 Dental Management of a Local Anesthetic Allergy

P Patient Evaluation and Risk Assessment (see Box 1.1)		Blood pressure	Monitor blood pressure during severe allergic reaction.
<ul style="list-style-type: none"> Evaluate and determine whether allergy to local anesthetic exists. Obtain medical consultation if undiagnosed or if uncertain. 			C
Potential Issues and Factors of Concern		Chair position	During allergic reaction with a conscious patient, place in comfortable position. With unconscious patient, place in supine position.
A			D
Anesthesia	Establish history of reaction after use of local anesthetic.	Drugs	In cases of allergic reaction to several local anesthetic agents or when a previously used anesthetic cannot be identified, consider using diphenhydramine. Have injectable epinephrine (1:1000) and diphenhydramine available.
Anxiety	Distinguish that the reaction is not a vasovagal or syncopal reaction associated with anxiety.		E
Allergy	Determine the type of anesthetic used that triggered the allergy. A patient experiencing a true allergic reaction will demonstrate one or more of the following: soft tissue swelling, skin rash, rhinitis, or difficulty breathing. If the reaction is consistent with allergic reaction, the following should be done: Select anesthetic from a different chemical group: (1) Para-aminobenzoic acid (procaine) (2) Amide (lidocaine, mepivacaine, articaine) Aspirate, inject 1 drop of alternate anesthetic, and wait 5 minutes; if no reaction occurs, inject after the rest of the anesthetic needed is aspirated (be prepared to deal with an allergic reaction if one occurs).	Equipment	Emergency kit should be up to date and readily available.
	B	Emergencies or urgencies	For severe allergic reaction (e.g., anaphylaxis), inject 0.3 to 0.5 mL of 1:1000 epinephrine through an IM (into the tongue) or SC route; supplement with IV diphenhydramine 50 to 100 mg if needed. Support respiration, if indicated, by mouth-to-mouth breathing or bag and mask.
Bleeding	No issues		F
Breathing	Breathing difficulties can be avoided by avoiding the allergen (local anesthetic) until after allergy testing is completed; thereafter use a local anesthetic to which patient is not allergic.	Follow-up	If history includes allergy to multiple substances, or if type of local anesthetic used previously cannot be identified, refer the patient to an allergist for PDT. Follow up with physician regarding results of tests.

IM, Intramuscular; IV, intravenous; PDT, provocative dose testing; SC, subcutaneous.

can attempt to contact the previous dentist involved. If this fails, two additional options are available:

- An antihistamine (e.g., diphenhydramine [Benadryl]) can be used as the local anesthetic.
- The patient may be referred to an allergist for provocative dose testing (PDT).

The use of diphenhydramine often is the more practical option. A 1% solution of diphenhydramine that contains 1:100,000 epinephrine can be easily compounded by a pharmacist, but it must be confirmed that methylparaben is not used as a preservative. This solution induces anesthesia of about 30 minutes' average duration and can be used for infiltration or block injection. When it is used for a mandibular block, 1 to 4 mL of solution is needed. Some patients have reported a burning sensation, swelling, or erythema after a mandibular block with 1%

diphenhydramine, but these effects were not serious and cleared within 1 or 2 days. No more than 50 mg of diphenhydramine should be given during a single appointment. Diphenhydramine also can be used in patients who report a previous allergic reaction to either an ester or amide local anesthetic.^{23,26}

The dentist may elect to refer the patient to an allergist for evaluation and testing, which usually includes both skin testing and PDT. Most investigators agree that skin testing alone for allergy to local anesthetics is of little benefit because false-positive results are common; therefore, the allergist also should perform PDT. Sending samples for specific testing of the clinician's usual anesthetic agents without vasoconstrictors is of great help.

The allergist, based on the patient's history, selects a local anesthetic for testing that is least likely to cause an allergic reaction; this usually is an anesthetic from the

amide group because they generally do not cross-react with each other. At 15-minute intervals, 0.1 mL of test solution is injected subcutaneously, with concentrations increasing from 1:10,000 to 1:1000 to 1:100 to 1:10, followed by undiluted solution; next, 0.5 mL of undiluted test solution is tried; and finally, 1 mL of undiluted solution is given. During PDT, the allergist should be prepared to deal with any adverse reaction that might occur and should report to the dentist on the drug selected, the final dose given, and the presence or absence of any adverse reaction. After testing, a local anesthetic that does not cause a reaction can be used, and the risk of an allergic reaction is no greater than in the general population. Malamed has reported that he has not dealt with a single patient for whom a safe local anesthetic could not be found through the PDT procedure.²³

When administering an alternative anesthetic to a patient with a history of a local anesthetic allergy, the dentist should follow these steps:

1. Inject slowly, aspirating first to make sure that a vessel is not being injected.
2. Place 1 drop of the solution into the tissues.
3. Withdraw the needle and wait 5 minutes to see what reaction, if any, occurs. If an allergic reaction does not occur, the anesthetic can be delivered at the recommended dose for the procedure. Be sure to aspirate before giving the second injection.

Antibiotics: Penicillin. Penicillin is used frequently throughout the world and is a common cause of drug allergy. In the United States, about 5% to 10% of the population is allergic to penicillin and penicillin-related drugs. About 0.04% to 0.2% of patients treated with penicillin develop an anaphylactic reaction, which is fatal in about 1 in 100,000 of penicillin-treated patients, accounting for some 400 to 800 deaths per year.^{1,4,29,30}

The possibility of sensitizing a patient to penicillin varies with different routes of administration, as follows^{3,4,26}: Oral administration results in sensitization of only about 0.1% of patients, intramuscular injection in about 1% to 2%, and topical application in about 5% to 12%. On the basis of these data, the use of penicillin in a topical ointment is contraindicated. Additionally, if the dentist has a choice, the oral route is preferable for administration whenever possible. Parenteral administration of penicillin evokes a more serious reaction than that typically associated with oral administration. Some investigators have suggested that the risk is equally great for a serious allergic reaction with both routes. Antibodies produced against penicillin cross-react with the semisynthetic penicillins and may cause severe reactions in patients who are allergic to penicillin. Nevertheless, the synthetic penicillins seem to cause fewer new sensitizations in patients who are not allergic to penicillin at the time of administration.

Skin testing for allergy to penicillin is much more reliable than is skin testing for allergy to a local anesthetic; however, some risk is involved, and the allergist must be

prepared for adverse reactions. Several points should be considered in the use of skin testing for penicillin sensitivity. To be cost-effective, the test should be conducted only on patients with a history of penicillin reaction who need penicillin for a serious infection. An important point is that penicillin reactivity declines with time; hence, a patient may have reacted to the drug years ago but is now no longer sensitive by testing (i.e., negative skin test result). The length of time for retaining sensitivity is variable and is dependent on IgE levels. Most anaphylactic reactions to penicillin occur in patients who have been treated in the past with penicillin but reported no adverse reactions.^{1,4,11,26}

When skin testing for penicillin sensitivity is performed, both metabolic breakdown products of penicillin (the major derivative, penicilloyl polylysine, and the minor derivative mixture) must be tested; 95% of penicillin is metabolized to the major determinant and 5% to the minor determinants. If skin test results are negative for both breakdown products, the patient is considered not allergic to penicillin; however, if positive skin test results are obtained for one or both of the breakdown products, the patient is considered to be allergic to penicillin, and the drug should not be used. When penicillin must be used, the patient with a positive result on skin testing can be desensitized to it. The incidence of anaphylactic reactions is higher in patients who test positive for the minor derivative mixture than do patients who test positive for the major derivative.^{1,4,11,26}

In dentistry, a patient who self-reports allergy to penicillin should be carefully interviewed to determine the plausibility of the allergy. If the information provided is convincing, then the patient is generally best treated with an alternative antibiotic. For example, patients with a history of penicillin allergy should be given erythromycin or clindamycin for the treatment of oral infection or clindamycin for prophylaxis against infective endocarditis. Additionally, drugs that may cross-react, including ampicillin, carbenicillin, and methicillin, should be avoided in these patients.^{11,26}

Cephalosporins are often used as alternatives to penicillins, but cephalosporins cross-react in 5% to 10% of penicillin-sensitive patients. The risk is greatest with first- and second-generation drugs. Cephalosporins are metabolized to their major determinant, cephaloal, which may cross-react with the major determinant of penicillin. Cephalosporins usually can be used in patients with a history of distant, nonserious reaction to penicillin. However, skin testing is recommended for these patients by some investigators. If the patient's penicillin skin test result is negative, then penicillin or a cephalosporin may be used. If the penicillin skin test result is positive, a skin test for the specific cephalosporin selected should be performed. If this skin test result is negative, the cephalosporin that was tested can be used. [Box 19.8](#) summarizes the use of cephalosporins in patients who have a history of penicillin hypersensitivity.^{11,23,26}

BOX 19.8 Use of Cephalosporins in Patients With a History of Penicillin Hypersensitivity

Cephaloyl, a major metabolite of cephalosporins, can cross-react with major determinant of penicillin (penicilloyl polylysine).

Risk of adverse reaction to cephalosporin is controversial.

- Greatest with first- or second-generation drugs:
 - Cephaloridine (16.5%), cephalothin (5%), cephalexin, 5.4%
- Anaphylaxis
 - Positive history of penicillin reaction, 0.1%
 - Negative history of penicillin reaction, 0.4%
- Urticaria
 - Positive history of penicillin reaction, 1.3%
 - Negative history of penicillin reaction, 0.4%

Patient with history of penicillin reaction: first skin test for penicillin sensitivity

- Negative—Use penicillin or a cephalosporin.
- Positive
 - Avoid penicillin.
 - Skin test is specific for cephalosporin; use cephalosporin if result is negative.

Data from Lichtenstein LM, Busse WW, Geha RS: *Current therapy in allergy, immunology and rheumatology*, ed 6, London, 2004, Mosby.

BOX 19.9 Procedures for Prevention of a Penicillin Reaction

1. Have emergency kit available.
2. Take medical history on all patients, including the following:
 - a. Previous contact with penicillin
 - b. Reactions to penicillin
 - c. Allergic reactions to other agents
3. Do not use penicillin in patient with a history of reactions to drugs.
4. Inform patient.
5. Do not use penicillin in topical preparations; instead use oral formulations when indicated.
6. Do not use penicillinase-resistant penicillins unless infection is caused by penicillinase-producing staphylococci.
7. Use disposable syringes for injection of penicillin.
8. Have patient wait in office for 30 minutes after first dose of penicillin is given.
9. Inform patient about signs and symptoms of allergic reaction to penicillin and, if these occur, to seek immediate medical assistance.

Patients with a negative history of allergy to penicillin can be treated with the drug when indicated, and the drug should be given by the oral route. The patient is observed for 30 minutes after the first dose, if possible, and is advised to seek immediate care if any signs or symptoms of an allergic reaction occur after she or he has left the dental office (Box 19.9).

Analgesics. Aspirin may cause gastrointestinal (GI) upset, but this problem can be avoided if it is taken with food or a glass of milk. The discomfort may include

“heartburn,” nausea, vomiting, or GI bleeding. Aspirin should not be used by patients with an ulcer, gastritis, or a hiatal hernia and should be used with care by patients whose condition predisposes them to nausea, vomiting, dyspepsia, or gastric ulceration. Aspirin also is known to prolong prothrombin time and to inhibit platelet function, which is usually of little clinical importance, except in patients with a hemorrhagic disease or a peptic ulcer. In such instances, aspirin must be avoided. Many people (about 2 in 1000) are allergic to salicylates. Allergic reactions to aspirin can be serious, and deaths have been reported.^{1,4,11}

Aspirin provokes a severe reaction in some patients with asthma. They may react in the same way to other nonsteroidal antiinflammatory drugs (NSAIDs) that inhibit cyclooxygenase, which is the key enzyme involved in the generation of prostaglandin from arachidonic acid. The typical reaction consists of acute bronchospasm, rhinorrhea, and urticaria. Most patients with asthma who react to NSAIDs also have nasal polyps and nasal eosinophilia. The mechanism for this reaction involves abnormal leukotriene E₄ levels as a result of synthesis by the eosinophils.³¹⁻³³ NSAIDs should not be given to these patients, and the dentist should be aware of the many combination analgesic preparations that include aspirin or other salicylates. These agents must not be given to the patient who may be endangered by an adverse reaction associated with aspirin or other salicylates.^{1,11} Also, NSAIDs should not be given to certain patients with an ulcer or hemorrhagic disease, pregnant or nursing mothers, and patients with advanced renal disease.

Codeine is a narcotic analgesic that commonly is used in dentistry. Emesis, nausea, and constipation may occur with analgesic doses of codeine. Miosis and adverse renal, hepatic, cardiovascular, and bronchial effects are not likely to occur with therapeutic doses. Most of the reported reactions to codeine consist of nonallergic GI manifestations; nevertheless, these may be severe enough to preclude the use of codeine in certain patients. Alternate drug selections may be made after by consulting a drug website (e.g., Micromedex) or current pharmacology text, such as *Physicians' Desk Reference* or *Accepted Dental Therapeutics*.

Dental Materials and Products

Type I, III, and IV hypersensitivity reactions have been reported to result from various dental materials and products. Topical anesthetic agents have been reported to cause type I reactions consisting of urticarial swelling. Mouth rinses and toothpastes containing phenolic compounds, antiseptics, astringents, or flavoring agents have been known to cause type I, III, and IV hypersensitivity reactions involving the oral mucosa or lips. Hand soaps used by dental care workers also have been reported as a cause of type IV reactions. Some of the dental agents that can lead to type IV hypersensitivity (contact stomatitis) include dental amalgam, acrylic, composite resin, nickel,

palladium, chromium, cobalt, eugenol, rubber products, talcum powder, mouthwashes, and toothpastes.^{13,34-38}

Latex Rubber Products. A number of reports have demonstrated that certain health care workers and patients are at risk for hypersensitivity reactions to latex or agents used in the production of rubber gloves or related materials (e.g., rubber dam, blood pressure cuff, catheters). Latex from surgical gloves has caused cardiovascular collapse in surgical patients, anaphylaxis in physicians, hypersensitivity reactions in health care workers, and anaphylaxis in other patients. About 1% to 6% of the general public is latex sensitive, but between 5% and 18% of health care providers are hypersensitive to latex. Although most cases in health providers are type IV reactions, caused by agents used in the production of rubber products, serious type I hypersensitivity reactions may occur in physicians, dentists, other health care workers, and patients as the result of contact with latex products such as gloves, rubber dams, or catheters.^{34,39}

Dentists should be aware that latex allergy can manifest as anaphylaxis during dental work when the patient or the dentist has been sensitized to latex. Anaphylaxis may occur in sensitized persons after contact has been made with rubber gloves, rubber dam material, blood pressure cuffs, or any other product containing latex. Studies have shown that latex-allergic persons have IgE antibodies for specific latex proteins. Latex skin tests are a satisfactory means of identifying individuals who may be sensitized to latex.^{13,34} Nitrile gloves should be considered for use to minimize these adverse reactions to latex proteins.⁴⁰

Hereditary Angioedema

Hereditary angioedema is a condition that can be provoked by infection, stress, trauma, or dental surgery. It is best managed by implementation of preventive measures with knowledge that some cases require the need for emergency tracheotomy or intubation.⁴¹ Prevention is implemented by providing androgens such as danazol and stanozolol. These drugs increase hepatic production of C1 inhibitor and help to decrease the number and severity of attacks. Newer agents that include recombinant C1 inhibitor concentrate (Cinryze or Berinert) show benefit when administered before surgery but are expensive.^{20,42} Use of such preventive agents is important because hereditary angioedema does not respond well to epinephrine or antihistamines, and epinephrine can in fact cause angioedema in these patients.

Other Conditions

Allergic patients who are being treated with steroids should be managed as described in [Chapter 15](#). Patients who have received an organ transplant should be managed as described in [Chapter 21](#). The dental management of patients with asthma is primarily concerned with preventing severe asthma attacks from occurring in the dental office and dealing with an attack, if it occurs. In addition,

certain important drug considerations must be applied in the management of these patients (see [Chapter 7](#)).

Treatment Planning Modifications

Dentists should obtain a history of any allergic reactions from each patient. If a patient has a history of allergy to drugs or materials that may be used in dentistry, a clear entry should be made in the dental record, and any further contact with or use of the antigen(s) should be avoided in that patient. Most allergic patients can receive any indicated dental treatment as long as the antigen is avoided and precautions are taken for patients receiving steroids or who are predisposed to angioedema. Drugs that can abort an allergic reaction should be readily available in all dental offices.²⁴

Oral Complications and Manifestations

Hypersensitivity

Type I Hypersensitivity. Oral lesions can be produced by type I hypersensitivity reactions. Atopic reactions to various foods, drugs, or anesthetic agents may occur within or around the oral cavity and usually are characterized by urticarial swelling or angioedema ([Fig. 19.3](#)). The reaction generally is rapid, with soft tissue swelling developing within a short time after coming into contact with the antigen. The painless swelling, produced by transudate from the surrounding vessels, may cause itching and burning. The lesion can last for 1 to 3 days if untreated but will resolve spontaneously. Oral antihistamines should be given; oral diphenhydramine, 50 mg every 4 hours, is the recommended regimen. Treatment is provided for 1 to 3 days. Further contact with the antigen must be avoided ([Box 19.10](#)).^{23,43}

Type III Hypersensitivity. Foods, drugs, or agents that are placed within the oral cavity can cause white, erythematous, or ulcerative lesions representative of type III hypersensitivity or immune complex reactions. These lesions develop usually within a 24-hour period, after contact is made with the offending antigen. Some cases of aphthous stomatitis ([Fig. 19.4](#)) may be caused by type III hypersensitivity, but most are related to immune



FIG 19.3 Angioedema of the upper lip that occurred soon after injection of a local anesthetic.

BOX 19.10 Oral or Paraoral Type I Hypersensitivity Reactions

1. Urticarial swelling (or angioedema)
 - a. A reaction occurs soon after contact with an antigen.
 - b. A reaction consists of painless swelling.
 - c. Itching and burning may occur.
 - d. A lesion may remain for 1 to 3 days.
2. Treatment
 - a. Reaction not involving tongue, pharynx, or larynx and with no respiratory distress noted requires 50 mg of diphenhydramine four times a day until swelling diminishes.
 - b. Reaction involving tongue, pharynx, or larynx with respiratory distress noted requires the following:
 - 0.5 mL of 1:1000 epinephrine, IM or SC
 - Oxygen
 - Once immediate danger is over, 50 mg of diphenhydramine should be given four times a day until swelling diminishes.

IM, Intramuscular; SC, subcutaneous.

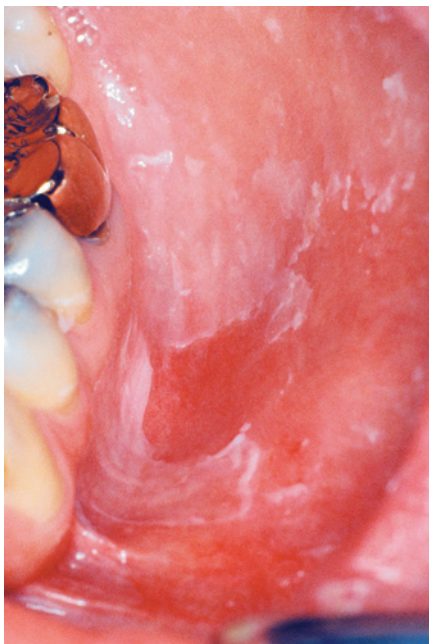

FIG 19.4 Stomatitis in a patient who was found to be allergic to the toothpaste he was using. (From Neville BW, Damm DD, Allen CM, et al: *Oral and maxillofacial pathology*, ed 3, St. Louis, 2009, Saunders.)

dysfunction that has not been fully characterized.⁴⁴⁻⁴⁶ Fig. 19.5 shows an allergic dermatitis that occurred after orthodontic brackets and archwires (containing nickel) were placed. Hypersensitivity reactions to orthodontic appliances are rare and seldom occur unless the patient has nickel hypersensitivity and a history of previous cutaneous or skin piercing.⁴⁷

Erythema multiforme represents an immune complex reaction that appears as polymorphous eruption of macules, erosions, and characteristic “target” lesions that



FIG 19.5 Allergic rash on the abdomen of a patient in whom orthodontic brackets and archwires were just placed. The patient was tested and was found to be allergic to the nickel in the wires.

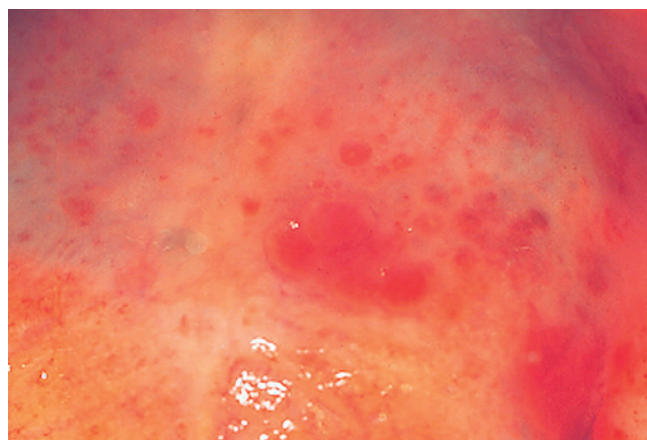

FIG 19.6 Erythema multiforme that developed after oral administration of a drug used to treat an oral infection. Ulceration of the palatal mucosa.

are symmetrically distributed on the skin or mucosa. Common sites in the mouth are the lips, buccal mucosa, and tongue (Fig. 19.6). In about half of affected patients, a predisposing factor such as a drug allergy or a herpes simplex infection is involved in the onset of their disease.⁴⁸⁻⁵⁰ Sulfa antibiotics are frequently associated with the onset of erythema multiforme. Sulfonyl urea hypoglycemic agents (e.g., tolbutamide, tolazamide, glyburide, glipizide), which are used to treat diabetes, also have been associated with the onset of erythema multiforme. Many patients with erythema multiforme can be treated with symptomatic therapy, including a bland mouth rinse, syrup of diphenhydramine, and topical or systemic corticosteroids (see Appendix C for treatment regimens). If a drug appears to be associated with onset of the disease, the drug should be withdrawn and any further contact with it should be avoided.

Type IV Hypersensitivity. Contact stomatitis is a delayed allergic reaction that often is associated with the cellular

immune response. Because of the delayed nature of the reaction after contact is made with the allergen, the dentist must inquire about contacts with materials that may have occurred days before the lesions appeared. The antigen may be found in dental materials, toothpaste, mouth rinses, lipsticks, cosmetics, and so forth. In many cases, no further treatment is necessary after the source of the antigen has been identified and removed from further contact with the patient; however, if the tissue reaction is severe or persistent, topical corticosteroids should be used (see [Appendix C](#) for treatment regimens).^{11,34,37}

Various dental materials have been reported as the cause of allergic reactions in patients. Impression materials containing an aromatic sulfonate catalyst have been reported to cause a delayed allergic reaction in postmenopausal women. The reactive lesion consists of tissue ulceration and necrosis that becomes progressively worse with each exposure.³⁷

Some investigators have reported that oral lesions may be found in close association with amalgam restorations. These (mucosal) lesions appear as whitish, reddish, ulcerative, or “lichenoid” and appear to be a hypersensitivity reaction to components of the amalgam restoration. When these restorations are removed, the lesions most often clear. Reports have suggested that some of the oral lesions resulted from toxic injury to the mucosa, and the majority are a result of type IV hypersensitivity reaction to heavy metals in amalgam.⁵¹⁻⁵⁴

Several studies performed to date have not correlated symptoms such as depression, fatigue, and headache with the effects of mercury in amalgam restorations. The practice of avoiding the use of amalgam restorations in patients with these nonspecific symptoms has, at present, no scientific basis. However, removal of any amalgam restorations in contact with oral mucosa that shows lesions consistent with a toxic or hypersensitivity reaction to mercury is rational.

On rare occasions, dental composite materials have been reported to cause allergic reactions. The acrylic monomer used in denture construction has caused an allergic reaction; however, the vast majority of tissue changes under dentures result from trauma and secondary infection with bacteria or fungi. Gold, nickel, and mercury have been reported to cause allergic reactions that result in tissue erythema and ulceration^{37,38,43} ([Fig. 19.7](#)).

The dentist may wish to test agents that are thought to be possible antigens that cause oral lesions. Oral epimucous testing for contact stomatitis consists of placing the suspected antigen in contact with the oral mucosa and observing for any reaction over a period of several days (e.g., erythema, sloughing, ulceration) that might indicate an allergy to the test material. In most cases, a reaction is not expected to develop for at least 48 to 72 hours. Various techniques have been used to conduct epimucous testing for suspected allergens. One of these involves placing the suspected allergen in a rubber suction cup, placing the cup on the buccal mucosa, and observing



FIG 19.7 Allergic reaction to removable partial denture framework. Note the erythematous demarcation.

at intervals for erythema or ulceration under the cup. Another technique is to place a sample of the suspected antigen in a depression on the palatal aspect of an overlay denture. The denture is inserted and holds the allergen in contact with the palatal mucosa.

Another technique consists of incorporating the allergen into Orabase, applying the Orabase to the mucobuccal fold, and periodically observing for a reaction. Alternately, the antigen can be incorporated into an oral adhesive spray. Skin testing and oral epimucous testing for potential antigens are not foolproof by any means; in certain patients, they yield unreliable tissue responses. The response in some cases may be caused by trauma; in other cases, in which a tissue reaction does not occur, the patient may still be allergic to the substance.

Basic management of contact stomatitis requires removal of common sources of antigens known to cause hypersensitivity reactions and assessment for lesion healing.⁴⁶ Skin or mucosal testing for sensitivity also can be performed. After the offending agent or antigen has been identified, the patient should be told to avoid any future contact with the antigen. Again, if the lesions persist, topical steroids can be applied (see [Appendix C](#)).

Lichenoid Drug Eruptions

Some patients with skin or oral lesions identical to those of lichen planus will be found to be taking certain drugs that cause lichenoid reactions.^{55,56} If the offending drug is withdrawn, the lesions clear within several days (in most patients) or within a few weeks. The agents most commonly associated with the onset of lichenoid lesions are levamisole (Levantine) and quinidine drugs. Other agents associated with such lesions are thiazides, gold, mercury, methyl dopa, phenothiazines, quinidine, and certain antibiotics. A biopsy, if performed, will show a microscopic picture similar to that seen in lichen planus, with the additional finding of eosinophils in the subepithelial infiltrate. These lesions are related to the cellular immune system and therefore could be categorized as a manifestation of contact stomatitis.

MANAGEMENT OF SEVERE TYPE I HYPERSENSITIVITY REACTIONS

Even when the dentist has taken appropriate precautions, an allergic reaction may occur. Most of these reactions are mild and of a nonemergency nature; however, some may be severe and life threatening (anaphylactic). The dentist must be ready to deal with either type. In handling the anaphylactic reaction, the dentist should remember that it has an allergic origin. In other words, the reaction occurs soon (within minutes) after the injection, ingestion, or application of a topical anesthetic, medication, drug, local anesthetic, or dental product. The dentist must immediately take the following actions (see [Appendix A](#)):

- Place the patient in a head-down or supine position.
- Make certain that the airway is open.
- Administer oxygen.
- Be prepared to send for help and support respiration and circulation. The rate and depth of respiration should be noted, as should the patient's other vital signs. Most reactions in dental patients consist of simple fainting,

which can be well managed by the preceding actions. In addition, the dentist may administer aromatic spirits of ammonia through inhalation, which encourages breathing through reflex stimulation.

- If these initial steps have not solved the emergency problem and the cause is highly likely to be allergic, an edematous-type or anaphylactic reaction should be considered.

Angioedema

If an immediate type I hypersensitivity reaction has resulted in edema of the tongue, pharyngeal tissues, or larynx, the dentist must take additional emergency steps to prevent death from respiratory failure. At this point, if the patient has not responded to the initial procedures and is in acute respiratory distress, the dentist should do the following:

- Activate emergency medical service (EMS; call 911).
- Inject 0.3 to 0.5 mL of 1:1000 epinephrine by an intramuscular (into the tongue) or subcutaneous route.

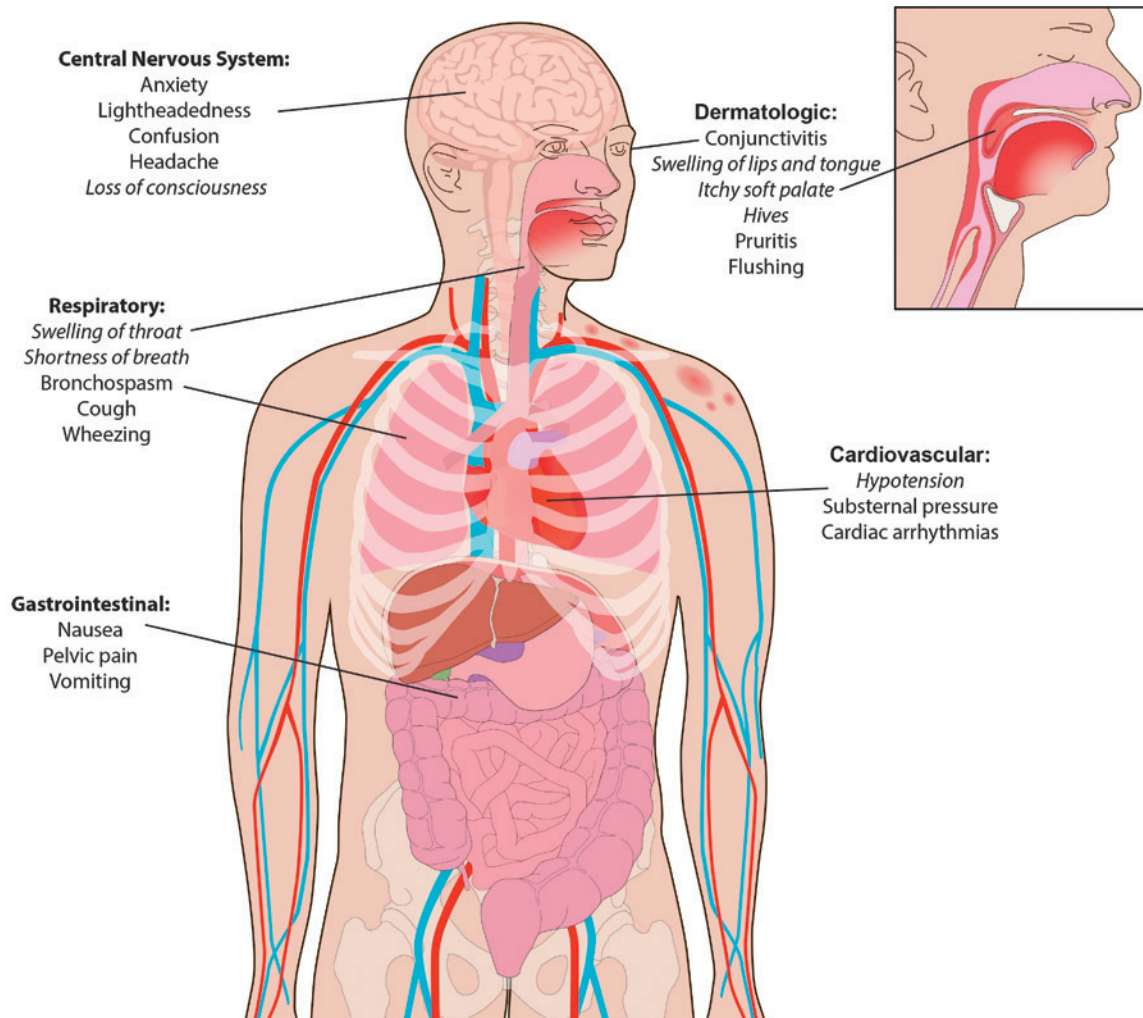

FIG 19.8 Signs and symptoms of anaphylaxis.

BOX 19.11 Anaphylaxis Management

1. Call 911 to activate EMS.
2. Place patient in the supine position.
3. Check for and establish an open airway.
4. Administer oxygen.
5. Check pulse, blood pressure, and respiration.
 - a. If any of the vital signs are depressed or absent, inject 0.3 to 0.5 mL 1:1000 epinephrine IM into the thigh or tongue.
 - b. Provide CPR if needed. Support respiration by mouth-to-mouth breathing.
 - c. Repeat IM injection of 0.5 mL 1:1000 epinephrine as needed every 5 minutes to control symptoms and blood pressure until emergency medical response arrives.

CPR, Cardiopulmonary resuscitation; EMS, emergency medical services; IM, intramuscular.

- Supplement with intravenous diphenhydramine 50 to 100 mg if needed.
- Support respiration, if indicated, by mouth-to-mouth breathing or bag and mask; the dentist should make sure the chest rises and falls when either of these methods is used.
- Check the carotid or femoral pulse; if a pulse cannot be detected, closed chest cardiac massage should be initiated.
- Confirm EMS is on their way and transport to medical facility if needed.

Anaphylaxis

Anaphylaxis is a potentially life-threatening emergency that usually occurs rapidly (i.e., within minutes) but may take longer. The signs and symptoms associated with anaphylactic reactions are shown in [Fig. 19.8](#). In contrast with a severe edematous reaction, in which respiratory distress occurs first, both respiratory and circulatory components of depression occur early in the anaphylactic reaction. Anaphylaxis often is fatal unless vigorous, immediate action is taken. Because it occurs often within minutes after contact with the antigen, the dentist should take the sequential steps delineated in [Box 19.11](#).

REFERENCES

1. Kay AB. Allergy and allergic diseases. First of two parts. *N Engl J Med*. 2001;344(1):30-37.
2. Verrill L, Bruns R, Luccioli S. Prevalence of self-reported food allergy in U.S. adults: 2001, 2006, and 2010. *Allergy Asthma Proc*. 2015;36(6):458-467.
3. Boyce JA, Austen KF. Allergies, anaphylaxis and systemic mastocytosis. In: Kasper DL, Fauci AS, Hauser SL, et al, eds. *Harrison's Principles of Internal Medicine*. 17th ed. New York: McGraw-Hill Education; 2015:2061-2070.
4. Lichenstein LM, Busse WW, Geha RS. *Current Therapy in Allergy, Immunology, and Rheumatology*. 6th ed. St. Louis: Mosby; 2004.
5. Malamed SF. Managing medical emergencies. *J Am Dent Assoc*. 1993;124(8):40-53.
6. Girdler NM, Smith DG. Prevalence of emergency events in British dental practice and emergency management skills of British dentists. *Resuscitation*. 1999;41(2):159-167.
7. Muller MP, Hansel M, Stehr SN, et al. A state-wide survey of medical emergency management in dental practices: incidence of emergencies and training experience. *Emerg Med J*. 2008;25(5):296-300.
8. Albin S, Agarwal S. Prevalence and characteristics of reported penicillin allergy in an urban outpatient adult population. *Allergy Asthma Proc*. 2014;35(6):489-494.
9. Idsoe O, Guthe T, Willcox RR, et al. Nature and extent of penicillin side-reactions, with particular reference to fatalities from anaphylactic shock. *Bull World Health Organ*. 1968;38(2):159-188.
10. Koplin JJ, Martin PE, Allen KJ. An update on epidemiology of anaphylaxis in children and adults. *Curr Opin Allergy Clin Immunol*. 2011;11(5):492-496.
11. Adkinson NF, Bochner BS, Burks WA, et al. *Middleton's Allergy: Principles and Practice*. 8th ed. St. Louis: Mosby/Elsevier; 2014.
12. Mullins RJ, Wainstein BK, Barnes EH, et al. Increases in anaphylaxis fatalities in Australia 1997 to 2013. *Clin Exp Allergy*. 2016.
13. Hamann CP, DePaola LG, Rodgers PA. Occupation-related allergies in dentistry. *J Am Dent Assoc*. 2005;136(4):500-510.
14. Miri S, Pourpak Z, Zarinara A, et al. Prevalence of type I allergy to natural rubber latex and type IV allergy to latex and rubber additives in operating room staff with glove-related symptoms. *Allergy Asthma Proc*. 2007;28(5):557-563.
15. Spring DB, Bettmann MA, Barkan HE. Nonfatal adverse reactions to iodinated contrast media: spontaneous reporting to the U.S. Food and Drug Administration, 1978-1994. *Radiology*. 1997;204(2):325-332.
16. Li X, Chen J, Zhang L, et al. Clinical observation of the adverse drug reactions caused by non-ionic iodinated contrast media: results from 109,255 cases who underwent enhanced CT examination in Chongqing, China. *Br J Radiol*. 2015;88(1047):20140491.
17. Botturi K, Vervloet D, Magnan A. T cells and allergens relationships: are they that specific? *Clin Exp Allergy*. 2007;37(8):1121-1123.
18. Romagnani S. T-cell subsets (Th1 versus Th2). *Ann Allergy Asthma Immunol*. 2000;85(1):9-18, quiz 18, 21.
19. Gell PH, Coombs RRA. Classification of allergic reactions responsible for clinical hypersensitivity and disease. In: Gell PGH, Coombs RRA, Hachmann PJ, eds. *Clinical Aspects of Immunology*. 3rd ed. Oxford, United Kingdom: Blackwell Scientific; 1975.
20. Zuraw BL, Christiansen SC. How we manage persons with hereditary angioedema. *Br J Haematol*. 2016.
21. Bernstein JA, Lang DM, Khan DA, et al. The diagnosis and management of acute and chronic urticaria: 2014 update. *J Allergy Clin Immunol*. 2014;133(5):1270-1277.
22. Khasawneh FA, Slaton MA, Katzen SL, et al. The prevalence and reliability of self-reported penicillin allergy in a community hospital. *Int J Gen Med*. 2013;6:905-909.

23. Malamed SF. Allergy and toxic reactions to local anesthetics. *Dent Today*. 2003;22(4):114-116, 18-21.
24. Becker DE. Drug allergies and implications for dental practice. *Anesth Prog*. 2013;60(4):188-197.
25. Ring J, Franz R, Brockow K. Anaphylactic reactions to local anesthetics. *Chem Immunol Allergy*. 2010;95:190-200.
26. Yagiela JA, Dowd FJ, Johnson B, et al. *Pharmacology and Therapeutics for Dentistry*. 6th ed. St. Louis, MO: Mosby/Elsevier; 2011.
27. Specia SJ, Boynes SG, Cuddy MA. Allergic reactions to local anesthetic formulations. *Dent Clin North Am*. 2010;54(4):655-664.
28. Ivy RS. Anesthetics and methylparaben. *J Am Dent Assoc*. 1983;106(3):302.
29. Shehab N, Patel PR, Srinivasan A, et al. Emergency department visits for antibiotic-associated adverse events. *Clin Infect Dis*. 2008;47(6):735-743.
30. International Collaborative Study of Severe A. Risk of anaphylaxis in a hospital population in relation to the use of various drugs: an international study. *Pharmacoepidemiol Drug Saf*. 2003;12(3):195-202.
31. Douglas GC, Karkos PD, Swift AC. Aspirin sensitivity and the nose. *Br J Hosp Med (Lond)*. 2010;71(8):442-445.
32. Micheletto C, Visconti M, Tognella S, et al. Aspirin induced asthma (AIA) with nasal polyps has the highest basal LTE4 excretion: a study vs AIA without polyps, mild topic asthma, and normal controls. *Eur Ann Allergy Clin Immunol*. 2006;38(1):20-23.
33. Forer B, Landsberg R, Kivity S. Aspirin challenge in patients with chronic rhinosinusitis with polyps correlates with local and systemic inflammatory markers. *Am J Rhinol Allergy*. 2013;27(6):e170-e173.
34. Cullinan P, Brown R, Field A, et al. Latex allergy. A position paper of the British Society of Allergy and Clinical Immunology. *Clin Exp Allergy*. 2003;33(11):1484-1499.
35. Hosoki M, Bando E, Asaoka K, et al. Assessment of allergic hypersensitivity to dental materials. *Biomed Mater Eng*. 2009;19(1):53-61.
36. Gawkrödger DJ. Investigation of reactions to dental materials. *Br J Dermatol*. 2005;153(3):479-485.
37. Pretorius E. Allergic reactions caused by dental restorative products. *SADJ*. 2002;57(9):372-375.
38. Kalimo K, Mattila L, Kautiainen H. Nickel allergy and orthodontic treatment. *J Eur Acad Dermatol Venereol*. 2004;18(5):543-545.
39. Dieguez MC, Pulido Z, de la Hoz B, et al. Latex allergy in healthcare workers: an epidemiological study in a Spanish hospital. *Allergy Asthma Proc*. 2007;28(5):564-570.
40. Nurses AoPR. AORN latex guideline. *AORN J*. 2004;79(3):653-672.
41. Jose J, Zacharias J, Craig T. Review of select practice parameters, evidence-based treatment algorithms, and international guidelines for hereditary angioedema. *Clin Rev Allergy Immunol*. 2016.
42. Three new drugs for hereditary angioedema. *Med Lett Drugs Ther*. 2010;52(1345):66-67.
43. Maeda S, Miyawaki T, Nomura S, et al. Management of oral surgery in patients with hereditary or acquired angioedemas: review and case report. *Oral Surg Oral Med Oral Pathol Oral Radiol Endod*. 2003;96(5):540-543.
44. Chattopadhyay A, Shetty KV. Recurrent aphthous stomatitis. *Otolaryngol Clin North Am*. 2011;44(1):79-88, v.
45. Femiano F, Lanza A, Buonaiuto C, et al. Guidelines for diagnosis and management of aphthous stomatitis. *Pediatr Infect Dis J*. 2007;26(8):728-732.
46. Stoopler ET, Sollecito TP. Oral mucosal diseases: evaluation and management. *Med Clin North Am*. 2014;98(6):1323-1352.
47. Kolokitha OE, Kaklamanos EG, Papadopoulos MA. Prevalence of nickel hypersensitivity in orthodontic patients: a meta-analysis. *Am J Orthod Dentofacial Orthop*. 2008;134(6):722.e1-22.e12, discussion 22-3.
48. Lamoreux MR, Sternbach MR, Hsu WT. Erythema multiforme. *Am Fam Physician*. 2006;74(11):1883-1888.
49. Sanchis JM, Bagan JV, Gavalda C, et al. Erythema multiforme: diagnosis, clinical manifestations and treatment in a retrospective study of 22 patients. *J Oral Pathol Med*. 2010;39(10):747-752.
50. Celentano A, Tovar S, Yap T, et al. Oral erythema multiforme: trends and clinical findings of a large retrospective European case series. *Oral Surg Oral Med Oral Pathol Oral Radiol*. 2015;120(6):707-716.
51. Issa Y, Duxbury AJ, Macfarlane TV, et al. Oral lichenoid lesions related to dental restorative materials. *Br Dent J*. 2005;198(6):361-366, discussion 549; quiz 372.
52. Koch P, Bahmer FA. Oral lesions and symptoms related to metals used in dental restorations: a clinical, allergological, and histologic study. *J Am Acad Dermatol*. 1999;41(3 Pt 1):422-430.
53. Martin MD, Broughton S, Drangsholt M. Oral lichen planus and dental materials: a case-control study. *Contact Dermatitis*. 2003;48(6):331-336.
54. Syed M, Chopra R, Sachdev V. allergic reactions to dental materials-a systematic review. *J Clin Diagn Res*. 2015;9(10):ZE04-ZE09.
55. Dudhia BB, Dudhia SB, Patel PS, et al. Oral lichen planus to oral lichenoid lesions: evolution or revolution. *J Oral Maxillofac Pathol*. 2015;19(3):364-370.
56. Yuan A, Woo SB. Adverse drug events in the oral cavity. *Oral Surg Oral Med Oral Pathol Oral Radiol*. 2015;119(1):35-47.

Rheumatologic Disorders

DEFINITION

Rheumatologic (or rheumatoid) disorders include much more than “arthritis” and encompass a large group (nearly 100) of disorders that affect bones, joints, and muscles.^{1,2} *Arthritis* is a nonspecific term that means “inflammation of the joints.” Often *arthritis* is used interchangeably with *rheumatism* or *rheumatoid arthritis* (RA) to denote aches, pains, and stiffness in the joints and muscles, but these terms are not synonymous nor inclusive. Rheumatologic disorders include RA, osteoarthritis (OA), psoriatic arthritis (PsA), systemic lupus erythematosus (SLE), juvenile rheumatoid arthritis (JRA), scleroderma (SD), Sjögren syndrome (SS), gout, ankylosing spondylitis, Lyme disease, giant cell arteritis (GCA or temporal arteritis), and fibromyalgia syndrome (FMS).¹⁻³

In this chapter, RA, OA, SLE, and SS are presented in more detail, and PsA, Lyme disease, GCA, and FMS are discussed to a lesser degree.

Rheumatologic disorders have significant personal and economic impact. According to the Arthritis Foundation,¹ more than 40 million Americans have various forms of arthritis, and more than 8 million of them are considered “disabled.” In terms of its overall economic impact, arthritis costs the American economy more than \$20 billion annually and accounts for nearly 30 million lost workdays per year.¹

COMPLICATIONS: Patients with rheumatic disease undergoing dental treatment may be at risk for infection, bleeding, drug interactions, and adverse effects. These events could prove serious. The dentist must be able to identify these patients, assess risk based on history and clinical findings, and work closely with the managing physician to develop a dental management plan that will be effective and safe for the patient.³⁻⁶

CATEGORIES OF RHEUMATOLOGIC DISORDERS

Rheumatologic disorders can be classified into nine categories, defined by the predominantly affected tissues, such as joint, synovium, cartilage, or connective tissues (Table 20.1). At each point in the evaluation (history,

physical examination, and laboratory testing), it is important to identify the tissues involved.

PATHOPHYSIOLOGY AND COMPLICATIONS

Structures commonly involved in rheumatologic disorders include the joint, the joint cavity, synovial fluid, and periarticular structures. The lining membrane, known as the *synovium*, consists of a thin layer of macrophages (type A cells) and fibroblasts (type B cells) with a sublining of rich, vascular, loose connective tissue. Hyaline cartilage overlies the bony endplates and provides a cushion to joint motion.^{2,3} The cartilage has high water content and obtains its nutrition solely from the synovial fluid, which is derived from the synovium primarily as an ultrafiltrate of plasma. The synovium also secretes specialized molecules into the synovial fluid, such as hyaluronic acid. An intact bony endplate is required to support the cartilage. The joint capsule and ligaments provide further support and blend with the periosteum. Periarticular anatomy is equally important and includes the tendons, bursae, and muscles associated with the joint.^{2,3}

Synovial inflammatory disorders, such as RA, begin in the synovium and secondarily damage the cartilage, joint capsule, and bone.^{2,3} Inflammation at entheses, the insertion sites of tendons or ligaments on bone, is characteristic of the spondyloarthropathies, such as ankylosing spondylitis. Crystal deposition disorders, such as gout or pseudogout, may also cause articular inflammation. Infections primarily involve the joint cavity (septic arthritis) or bone (osteomyelitis). OA is a noninflammatory, degenerative disease that begins in the cartilage and leads to cartilage loss, subchondral new bone formation, and marginal bony overgrowth.^{2,3} Osteonecrosis of bone may be associated with secondary cartilage damage after collapse of the bony endplate. Inflammatory diseases of the muscle usually manifest with painless proximal weakness. Periarticular inflammation may involve tendons or bursae, and these structures are common causes of pain and stiffness, often misinterpreted as arising from the joint itself.^{2,3} Fibromyalgia (FM; widespread muscle pain) is characterized by soft tissue pain with local tenderness in specific points but without abnormal blood studies.³

Although the rheumatologic diseases comprise a group of more than 100 important diseases, this chapter is limited

TABLE 20.1 Classification of Musculoskeletal Diseases

Category	Prototype(s)	Useful Test(s)	Treatment(s)*
Synovitis	Rheumatoid arthritis Autoimmune diseases	Rheumatoid factor, ESR ANA test	DMARDs and biologic agents Prednisone and immunosuppressive drugs
Enthesopathy	Ankylosing spondylitis and spondyloarthropathies	Sacroiliac radiographs	NSAIDs, MTX, and biologic agents
Crystal-induced synovitis	Gout CPPD (pseudogout)	Joint fluid crystal examination Radiographic chondrocalcinosis	NSAIDs NSAIDs
Joint space disease	Septic arthritis	Joint fluid culture	Antibiotics
Cartilage degeneration	Osteoarthritis	Radiographs of affected area	NSAIDs, analgesics, and physical therapy
Osteoarticular disease	Osteonecrosis	Radiographs, magnetic resonance imaging	Core decompression or prosthetic joint replacement
Inflammatory myopathy	Polymyositis Dermatomyositis Inclusion body myositis	Muscle enzymes, electromyography, muscle biopsy	Corticosteroids and immunosuppressive drugs
Local and regional conditions	Tendonitis or bursitis	Aspirate bursa if infection is suspected	Local injections
General conditions	Polymyalgia rheumatica Fibromyalgia	Elevated ESR Normal ESR	Corticosteroids Aerobic exercise, stretches, and sleep medications

*Biologic agents include anti-tumor necrosis factor (anti-tumor necrosis factor) drugs and others.

ANA, Antinuclear antibody; CPPD, calcium pyrophosphate crystal deposition disease; DMARD, disease-modifying antirheumatic drugs; ESR, erythrocyte sedimentation rate; MTX, methotrexate; NSAID, nonsteroidal antiinflammatory drug.

to a discussion of RA, OA, PsA, SLE, Lyme disease, FMS, temporal arteritis, and SS.

RHEUMATOID ARTHRITIS

DEFINITION

Rheumatoid arthritis is an autoimmune disease of unknown origin characterized by symmetric inflammation of joints, especially of the hands, feet, and knees. The severity of the disease varies widely from patient to patient and fluctuates over time within the same patient. Disease onset usually occurs between ages 35 and 50 years. RA is more prevalent in women than in men by a 3:1 ratio.¹⁻³

Epidemiology

Prevalence is somewhat difficult to determine because of lack of well-defined markers of the disease; however, estimates range from 1% to 2% of the U.S. population.^{1,2}

Etiology

The cause of RA is unknown; however, evidence seems to implicate an interrelationship of infectious agents, genetics, and autoimmunity.¹⁻³ One theory suggests that a viral agent alters the immune system in a genetically predisposed person, leading to destruction of synovial tissues. Although the disease can occur within families, suggesting a genetic component, specific associated genes have not been identified.^{2,4} Nevertheless, many people who develop RA have a genetic predisposition that occurs

in the form of a tissue marker called HLA-DR4; however, not everyone with this tissue type develops the disease.²⁻⁵

PATHOPHYSIOLOGY AND COMPLICATIONS

The fundamental abnormality of RA involves microvascular endothelial cell activation and injury.²⁻⁵ Primary changes occur within the synovium, which is the inner lining of the joint capsule (Fig. 20.1). Edema of the synovium occurs followed by thickening and folding. This excessive tissue, composed of proliferative and invasive granulation tissue, is referred to as *pannus*. In addition, marked infiltration of lymphocytes and plasma cells into the capsule occurs. Eventually, granulation tissue covers the articular surfaces and destroys the cartilage and subchondral bone through enzymatic activity (Fig. 20.2). This process also extends to the capsule and ligaments, causing distention and rupture. New bone or fibrous tissue then is deposited, resulting in loss of mobility.²⁻⁵

The sequence of pathologic events begins with a synovitis that stimulates immunoglobulin G (IgG) antibodies. These antibodies form antigenic aggregates in the joint space, leading to the production of rheumatoid factor (RF; autoantibodies). RF then complexes with IgG complement, a process that produces an inflammatory reaction that injures the joint space.²⁻⁵ The key drivers of RA include proinflammatory cytokines such as tumor necrosis factor- α (TNF- α), interleukin-1 (IL-1), and interleukin-6 (IL-6).⁵

An associated finding in 20% of patients with RA is the presence of subcutaneous nodules, which are commonly



FIG 20.1 The joint surface (*top*) has lost its cartilage and consists of granulation tissue with scar tissue. Subchondral bone shows degenerative changes and areas of necrosis. (Courtesy of A. Golden, Lexington, KY.)

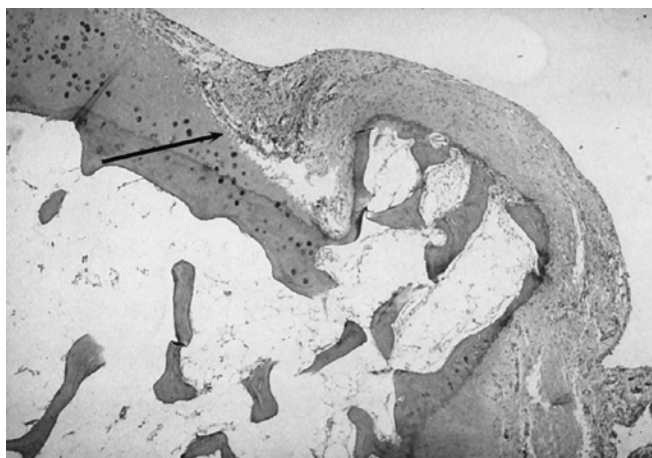

FIG 20.2 A micrograph of a pannus resulting from severe synovitis in rheumatoid arthritis. The pannus is eroding articular cartilage and bone (*arrow*). (Courtesy of Richard Estensen, MD, Minneapolis, MN.)

found around the elbow and finger joints. These nodules are thought to arise from the same antigen–antibody complex that is found in the joint. Antigen-mediated vasculitis confined to small- and medium-sized vessels also may occur.²⁻⁵

Rheumatoid arthritis is a pleomorphic disease with variable expression. The most progressive period of the disease occurs during the earlier years; thereafter, it slows. Onset is gradual in more than 50% of patients, and as many as 20% follow a limited course that abates within 2 years.²⁻⁵ Approximately 10% of patients with RA who do not receive adequate treatment experience relentless crippling that leads to nearly complete disability. The remainder follows a polycyclic or progressive course.²⁻⁵ The long-term prognosis for individuals with abrupt onset

TABLE 20.2 Comparison of the Clinical Features of Rheumatoid Arthritis and Osteoarthritis

Rheumatoid Arthritis	Osteoarthritis
Multiple symmetric joint involvement	Usually one or two joints (or groups) involved
Significant joint inflammation	Joint pain usually without inflammation
Morning joint stiffness lasting longer than 1 hour	Morning joint stiffness lasting less than 15 minutes
Symmetric, spindle-shaped swelling of PIP joints and volar subluxation of MCP joints and Bouchard's nodes of PIP joints	Heberden nodes of DIP joints
Systemic manifestations (fatigue, weakness, malaise)	No systemic involvement

DIP, Distal interphalangeal; *MCP*, metacarpophalangeal; *PIP*, proximal interphalangeal.

of disease is similar to that for those with gradual disease onset. The course and severity of RA are unpredictable, but the disorder is characterized by remissions and exacerbations. For most patients, however, the disease is a sustained, lifelong problem that can be managed to allow a normal or nearly normal life.²⁻⁵

The life expectancy of persons with severe RA is shortened by 10 to 15 years. This increased mortality rate usually is attributed to infection, pulmonary and renal disease, and gastrointestinal bleeding.²⁻⁵

Many complications may accompany RA, including skin ulcers, muscle atrophy, keratoconjunctivitis sicca (SS), digital gangrene, temporomandibular joint (TMJ) involvement, pulmonary interstitial fibrosis, pericarditis, amyloidosis, anemia, thrombocytopenia, neutropenia, and splenomegaly (Felty syndrome).²⁻⁵

CLINICAL PRESENTATION

The usual onset of RA is gradual and subtle (Table 20.2), and the disorder is commonly preceded by a prodromal phase of general fatigue and weakness with joint and muscle aches. Characteristically, these symptoms come and go over varying periods. Then, painful joint swelling, especially of the hands and feet, occurs in several joints and progresses to other joints in a symmetric fashion (Fig. 20.3). Joint involvement persists and gradually progresses to immobility, contractures, subluxation, deviation, and other deformities.²⁻⁵ Characteristic features include pain in the affected joints aggravated by movement, generalized joint stiffness after inactivity, and morning stiffness that lasts longer than 1 hour. The joints most commonly affected are fingers, wrists, feet, ankles, knees, and elbows. Multiple joint changes noted in the hands include a symmetric spindle-shaped swelling of the proximal interphalangeal (PIP) joints, with dorsal swelling



FIG 20.3 Hands of a patient with advanced rheumatoid arthritis. (From Damjanov I: *Pathology for the health professions*, ed 4, St. Louis, 2012, Saunders.)

BOX 20.1 Criteria for the Diagnosis of Rheumatoid Arthritis

- Morning stiffness
- Arthritis of three or more joint areas
- Arthritis of hand joints
- Symmetric arthritis
- Rheumatoid nodules
- Serum rheumatoid factor
- Radiographic changes

Adapted from Arnett FC, Edworthy SM, Bloch DA, et al: The American Rheumatism Association 1987 revised criteria for the classification of rheumatoid arthritis, *Arthritis Rheum* 31:315-324, 1988.

and characteristic volar subluxation of the metacarpophalangeal (MCP) joint (see Fig. 20.3). TMJ involvement occurs in up to 75% of RA patients.²⁻⁶ Because of the variable rate of progression and pain intensity, the median period between onset of symptoms of RA and its diagnosis is 36 weeks.^{1,7}

Extraarticular manifestations include rheumatoid nodules, vasculitis, skin ulcers, SS, interstitial lung disease, pericarditis, cervical spine instability, entrapment neuropathies, and ischemic neuropathies.^{3,8} The American Rheumatism Association has developed revised criteria for the diagnosis and classification of RA to be used in clinical trials and epidemiologic studies (Box 20.1).⁹ These criteria have high specificity (89%) and sensitivity (91%–94%) compared with control participants when used to classify patients with RA. For the diagnosis of RA to be made, four of seven criteria must be met.^{5,9}

Laboratory and Diagnostic Findings

Laboratory tests are not pathognomonic or diagnostic of RA, although they are used in conjunction with clinical findings to confirm the diagnosis.^{3-5,9} Laboratory findings most commonly seen in RA include an increased erythrocyte sedimentation rate (ESR), the presence of C-reactive

protein (CRP), a positive RF (in 85% of affected patients), and a hypochromic microcytic anemia. In patients with Felty syndrome (RA with splenomegaly), a marked neutropenia may be present.^{3-5,9}

Autoantibodies to cyclic citrullinated proteins (CCPs) are helpful in the diagnosis of RA.⁹ Anti-CCP antibodies are highly associated with RA. They occur in 70% to 80% of patients with RA as well as in some other forms of inflammatory arthritis. These antibodies may appear before any signs or symptoms of RA and therefore may prove beneficial as early screening markers for earlier diagnosis and intervention of RA.⁹

The American College of Rheumatology (ACR) has established criteria for the diagnosis of RA (see Box 20.1), the classification of severity by radiography, functional classes, and the definition of remission. Although they were not designed for managing individual patients, these criteria are useful as a frame of reference and for describing clinical phenomena.⁹

By definition, the diagnosis of RA cannot be made until the disease has been present for at least several weeks. Many extraarticular features of RA, the characteristic symmetry of inflammation, and the typical serologic findings may not be evident during the first few months after disease onset.^{3-5,9} Therefore, the diagnosis of RA usually is presumptive early in its course.

Although extraarticular manifestations may dominate in some patients, documentation of an inflammatory synovitis is essential for a diagnosis. Inflammatory synovitis can be documented by demonstration of synovial fluid leukocytosis, defined as white blood cell (WBC) counts greater than 2000/ μ L, histologic evidence of synovitis, or radiographic evidence of characteristic erosions.^{5-7,9,10}

MEDICAL MANAGEMENT

Treatment of RA focuses on use of antiinflammatory drugs and disease-modifying antirheumatic drugs (DMARDs), which are helpful in controlling disease and limiting joint damage.^{3-5,9} The treatment approach to RA is, by necessity, mostly palliative because no cure yet exists for the disease. The ultimate aims of management are to achieve disease remission and maintain or regain functional activity.^{3-5,9}

Clinical tools for monitoring the patient's well-being and the efficacy of therapy include self-assessment of the duration of morning stiffness and severity of fatigue, as well as functional, social, emotional, and pain status, as measured by a health assessment questionnaire. A patient-derived global assessment based on a visual analogue scale is a simple and effective means of recording patient well-being. The number of tender and swollen joints is a useful measure of disease activity, as is the presence of anemia, thrombocytosis, and elevated ESR or CRP. Serial radiographs of target joints, including the hands, are useful in assessing disease progression.^{3-5,9}

Patient education is essential early in the disease course and on an ongoing basis. Patients are best served by a

multidisciplinary approach with early referral to a rheumatologist and other specially trained medical personnel, including nurses, counselors, and occupational and physical therapists who are skilled and knowledgeable about RA.^{3-5,9} Appropriate medical care of patients with RA encompasses attention to smoking cessation, immunizations, prompt treatment of infections, and management of comorbid conditions such as diabetes, hypertension, and osteoporosis.^{3-5,9} Remission is elusive, however, so more practical treatment goals are to reduce joint inflammation and swelling, relieve pain and stiffness, and facilitate and encourage normal function.⁸ These goals are accomplished through a basic treatment program that consists of patient education, rest, exercise, physical therapy, and various nonsteroidal antiinflammatory drugs (NSAIDs) and DMARDs.^{3-5,9-11}

The major goals of therapy are to reduce joint damage; relieve pain, swelling, and fatigue; improve joint function; and prevent disability and disease-related morbidity.^{3-5,9-11} These goals are constant throughout the disease course, although emphasis may shift to address specific patient needs.^{1,12,13}

Drugs for the management of RA have been traditionally, but imperfectly, divided into two groups: those used primarily for the control of joint pain and swelling and those intended to limit joint damage and improve long-term outcome (Table 20.3). Symptoms of pain and swelling in RA are mediated, at least in part, by intense cytokine activity. NSAIDs inhibit proinflammatory prostaglandins and are effective treatments for pain, swelling, and stiffness, but they have no effect on the disease course or on risk of joint damage.^{3-5,9-11} On the other hand, antiinflammatory properties have been noted for several DMARDs, which are used principally to control disease and to limit joint damage.^{3-5,9-11} These drugs include methotrexate and biologic response modifiers with actions targeted against specific cytokines, such as TNF- α . Corticosteroids are powerful, nonspecific inhibitors of cytokines and have been demonstrated to effectively delay joint erosion.^{3-5,9-11}

Many different drugs are used in the treatment of patients with RA. Some are used primarily to ease the symptoms of RA; others are used to slow or stop the course of the disease and to inhibit structural damage. Most of these drugs fall into one of the following categories.

NSAIDs

These drugs effectively reduce arthritis pain and inflammation. NSAIDs, including aspirin, constitute the cornerstone of treatment. A common approach is to start a patient on three 5-grain tablets four times a day and then to adjust the dosage on the basis of patient response. The most common sign of aspirin toxicity is tinnitus. If this occurs, dosage is decreased. In addition to aspirin, many NSAIDs are available for use (see Table 20.3).^{3,9-12} Some of the more common NSAIDs include cyclooxygenase (COX)-2 inhibitors, namely, celecoxib (Celebrex), ibuprofen

(Motrin, Advil, Rufen, Nuprin), naproxen (Naprosyn, Aleve), sulindac (Clinoril), tolmetin (Tolectin), fenoprofen (Nalfon), piroxicam (Feldene), diclofenac (Voltaren), flurbiprofen (Ansaid), diflunisal (Dolobid), etodolac (Lodine), and nabumetone (Relafen).^{3-5, 9-11} All NSAIDs can cause a qualitative platelet defect that may result in prolonged bleeding, especially when given in high doses. The effects of aspirin are irreversible for the life of the platelet (10–12 days); thus, this effect continues until new platelets have replaced the old. The effect of the other NSAIDs on platelets is reversible and lasts only as long as the drug is present in the plasma (see Chapter 24).^{3,9-12} Celecoxib (Celebrex), a COX-2 inhibitor, is designed to be safer for the stomach.^{3,9-12} In addition to NSAIDs, a variety of other drugs can be used to treat patients with RA (see Table 20.3).^{3,9-12}

Corticosteroids

Corticosteroids, including prednisone, prednisolone, and methylprednisolone, are potent and quick-acting antiinflammatory medications. These medications provide immediate control of inflammation while waiting for NSAIDs and DMARDs take effect. Because of the risk of side effects with corticosteroids, they are prescribed for as short a time as possible and in doses as low as possible.^{3,9-12}

DMARDs

Disease-modifying antirheumatic drugs, through various mechanisms, actually modify the course of the disease. The most commonly used DMARD for RA is methotrexate. Other frequently used DMARDs include hydroxychloroquine (Plaquenil), sulfasalazine (Azulfidine, Azulfidine EN-Tabs), leflunomide (Arava), and azathioprine (Imuran).^{3,9-12}

An individual diagnosed with RA is likely to be prescribed a DMARD fairly early in the course of the disease because studies have demonstrated that starting these drugs early can help prevent irreparable joint damage.^{3,9-12}

Biologic Agents

Biologic agents are highly targeted DMARDs that in many ways have revolutionized the management of RA. Biologics have been shown to help slow progression of RA when all other treatments have failed to do so. Aggressive RA treatment is known to help prevent long-term disability from RA.^{3,11,14}

A list of biologic drugs can be seen in Table 20.4. There are currently nine such agents approved for RA: abatacept (Orencia), adalimumab (Humira), anakinra (Kineret), certolizumab pegol (Cimzia), etanercept (Enbrel), infliximab (Remicade), golimumab (Simponi), and rituximab (Rituxan). Each of the biologics targets a specific molecular mediator in the inflammation cascade. Cimzia, Enbrel, Humira, Remicade, and Simponi block a cytokine called TNF- α and are referred to as TNF inhibitors or blockers. Kineret targets a cytokine called IL-1. Orencia

TABLE 20.3 Drugs Used in the Management of Rheumatologic Disorders

Drug(s) (Trade Name)	Dental and Oral Considerations
SALICYLATES	
Aspirin, Ascriptin, Bufferin, Anacin, Ecotrin, Empirin	Prolonged bleeding but not usually clinically significant
NONSTEROIDAL ANTIINFLAMMATORY DRUGS	
Ibuprofen (Motrin), fenoprofen (Nalfon), indomethacin (Indocin), naproxen (Naprosyn), meclufenamate (Meclomen), piroxicam (Feldene), sulindac (Sulindac), tolmetin (Tolectin), diclofenac (Voltaren), flurbiprofen (Ansaid), diflunisal (Dolobid), etodolac (Lodine), nabumetone (Relafen), oxaprozin, ketorolac	Prolonged bleeding but not usually clinically significant; oral ulceration, stomatitis
CYCLOOXYGENASE-2 INHIBITORS	
Celecoxib Rofecoxib	None
TUMOR NECROSIS FACTOR-α INHIBITORS	
Etanercept Infliximab	None
INJECTABLE GLUCOCORTICOIDS	
Triamcinolone hexacetonide Triamcinolone acetonide Prednisolone tebutate Methylprednisolone acetate Dexamethasone acetate Hydrocortisone acetate Triamcinolone diacetate Betamethasone sodium phosphate and acetate Dexamethasone sodium phosphate Prednisolone sodium phosphate	Adrenal suppression, masking of oral infection, impaired healing
SYSTEMIC GLUCOCORTICOIDS	
Hydrocortisone, cortisone, prednisone, prednisolone, dexamethasone, methylprednisolone (Deltasone, Meticorten, Orasone, Articulose-50, Delta-Cortef, Medrol)	Adrenal suppression, masking of oral infection, impaired healing
DISEASE-MODIFYING ANTIRHEUMATIC DRUGS	
ANTIMALARIAL AGENTS	
Hydroxychloroquine, quinine, chloroquine (Plaquenil)	None
PENICILLAMINES	
Cuprimine, Depen	None
GOLD COMPOUNDS	
Gold sodium thiomalate (Auranofin), aurothioglucose (Myochrysine Ridaura, Solganal) Aralen	Increased infections, delayed healing, prolonged bleeding, oral ulcerations Increased infections, delayed healing, prolonged bleeding, glossitis, stomatitis
Sulfasalazine Azulfidine	Increased infections, delayed healing, prolonged bleeding, intraoral pigmentation
IMMUNOSUPPRESSIVES	
Azathioprine, cyclophosphamide Methotrexate, cyclosporine, chlorambucil (Imuran, Cytoxan, Rheumatrex)	Increased infections, delayed healing, prolonged bleeding Increased infections, delayed healing, prolonged bleeding, stomatitis

TABLE 20.4 General Categories of Drugs to Treat Rheumatologic Disorders

There are many different drugs used in the treatment of rheumatologic disorders. Some are used primarily to ease the symptoms, and others are used to slow or stop the course of the disease and to inhibit structural damage. Most of these drugs fall into one of the following categories:

Nonsteroidal antiinflammatory drugs (NSAIDs) include more than a dozen different medications—some available over the counter, some available by prescription only—used to help ease arthritis pain and inflammation. NSAIDs include such drugs as ibuprofen (Advil, Motrin), ketoprofen (Actron, Orudis KT), and naproxen sodium (Aleve), among others. If you have had or are at risk of stomach ulcers, your doctor may prescribe celecoxib (Celebrex), a type of NSAID called a cyclooxygenase-2 inhibitor, which is designed to be safer for the stomach.

Corticosteroids: Corticosteroid medications, including prednisone, prednisolone, and methylprednisolone, are potent and quick-acting antiinflammatory medications. They may be used in patients with rheumatoid arthritis (RA) to get potentially damaging inflammation under control while waiting for NSAIDs and DMARDs (below) to take effect. Because of the risk of side effects with these drugs, doctors prefer to use them for as short a time as possible and in doses as low as possible.

Disease-modifying antirheumatic drugs (DMARDs): DMARDs are drugs that work slowly to actually modify the course of the disease. In recent years, the most commonly used DMARD for rheumatoid arthritis is methotrexate. But there are about a dozen others that fall into this category. They include hydroxychloroquine (Plaquenil), sulfasalazine (Azulfidine, Azulfidine EN-Tabs), leflunomide (Arava), and azathioprine (Imuran).

Patients diagnosed with RA today are likely to be prescribed a DMARD fairly early in the course of their disease because doctors have found that starting these drugs early on can help prevent irreparable joint damage that might occur if their use was delayed.

Biologic agents: The newest category of medications used for rheumatoid arthritis is a subset of DMARDs called biologic response modifiers, or biologics. There are currently nine such agents approved for RA: abatacept (Orencia), adalimumab (Humira), anakinra (Kineret), certolizumab pegol (Cimzia), etanercept (Enbrel), infliximab (Remicade), golimumab (Simponi), and rituximab (Rituxan).

Each of the biologics blocks a specific step in the inflammation process. Cimzia, Enbrel, Humira, Remicade, and Simponi block a cytokine called tumor necrosis factor- α (TNF- α) and therefore often are called TNF inhibitors. Kineret blocks a cytokine called interleukin-1 (IL-1). Orencia blocks the activation of T cells. Rituxan blocks B cells. Actemra blocks a cytokine called interleukin-6 (IL-6).

Because these agents target specific steps in the process, they do not wipe out the entire immune response as some other RA treatments do, and in many people, a biologic agent can slow, modify, or stop the disease even when other treatments have not helped much.

Janus kinase (JAK) inhibitors: A new drug, tofacitinib (Xeljanz) is being compared to biologics. However, it is part of a new subcategory of DMARDs known as JAK inhibitors that block Janus kinase, or JAK, pathways, which are involved in the body's immune response. Unlike biologics, it can be taken orally.

inhibits the activation of T cells. Rituxan targets CD20 thereby inactivating B cells. Actemra blocks a cytokine called IL-6. IL-6 is a proinflammatory cytokine that is usually increased in most rheumatologic disorders.^{3,9-12} The biologic agents etanercept and infliximab (and other TNF- α inhibitors) have been shown to be highly effective in the treatment of patients with early RA relative to the “gold standard” agent, methotrexate.^{3,11,14} Although costly and difficult to administer (requiring an injectable route), etanercept (e.g., Enbrel, Immunex) has been shown to significantly reduce symptoms of RA and to more effectively slow joint damage when compared with methotrexate.^{3,11,14} Likewise, infliximab (Remicade), which also is costly and requires administration by the intravenous (IV) route, when used with methotrexate significantly reduced RA symptoms and slowed joint damage to a greater extent than that achieved with methotrexate therapy alone.^{3,11,14}

These agents are administered by injection or IV infusion and usually have side effects.^{3-5,9-12} The most common side effect seen with biologics is pain and rash at the injection site. This occurs in fewer than 30% of patients.¹⁴ Because biologics given by infusion (in the vein) have the potential to cause an allergic infusion reaction, patients are monitored during infusions. Symptoms of infusion reactions include flulike illness, fever, chills, nausea, and headache.¹⁵ Biologics have also been implicated in increased

infections in patients using them. In fact, one study found that patients taking high-dose biologics were nearly 2.5 times more likely to have a serious infection than control participants.^{15,16}

As with any drugs that suppress the immune system, biologic therapy poses some increased to infections and other diseases. People taking biologics should seek immediate medical attention if they develop persistent fever or unexplained symptoms. Vaccinations that prevent infections should be considered before taking biologics. While taking biologic medications, people should not receive live vaccines.¹⁵

Janus-Associated Kinase Inhibitors

Tofacitinib (Xeljanz) is a janus-associated kinase inhibitor that disrupts cytokine and growth factor signaling pathways, thereby effectively reducing inflammation.^{3,9-12}

Prosthetic Joints

A potential long-term complication of chronic RA (also OA¹⁷ and other types, including fractures that do not heal and avascular necrosis) is the ultimate destruction of particular joint structures to the degree that the joint must be replaced with synthetic materials.¹⁷

Patients who have recently received a prosthetic joint (particularly the knee) are at increased risk (up to nine times more likely) to have a thromboembolic event

(including a possible myocardial infarction) within 1 month of the implant,¹⁸ and they are also more likely to have a pulmonary embolism for several years after their implant.¹⁸ Patients with prosthetic joints (most commonly, hip and knee replacement, followed by shoulder, elbow, wrist, and ankle) often are encountered in dental practice; when this occurs, a question concerning the need for antibiotic prophylaxis to prevent infection of the prosthesis can arise.

DENTAL MANAGEMENT

Depending on which joints are involved, patients may not be comfortable in a supine position in the dental chair. Consideration should be given to providing a more upright chair position, using neck, back, and leg supports, and scheduling short appointments (Box 20.2).^{19,20}

Dental appointments should be kept as short as possible, and the patient should be allowed to make frequent position changes as needed to accommodate joint pain and immobility (see Box 20.2). The patient also may be more comfortable in a sitting or semisupine position, as opposed to a supine one. Physical supports, such as a

pillow or a rolled towel, may be used to provide support for deformed limbs, joints, or the neck.^{19,20}

The most significant complications associated with RA are drug related (see Table 20.3). Aspirin and other NSAIDs can interfere with platelet function and cause prolonged bleeding; however, this effect alone generally is not found to be of clinical significance unless another bleeding problem is present.^{11,20-22} A patient who is taking both aspirin and a corticosteroid may be at greater risk for bleeding (see Chapter 24). The risk is not great, however, and patients usually can be treated as long as curettage or surgery is performed conservatively in small segments, with attention to good techniques (see Chapter 24).^{11,20-22}

Patients who are taking gold salts, penicillamine, sulfasalazine, or immunosuppressive agents are susceptible to bone marrow suppression, which can result in anemia, agranulocytosis, and thrombocytopenia. If a patient has not undergone recent laboratory testing, a complete blood cell count with a differential WBC count should be ordered. Abnormal results should be discussed with the patient's physician. Patients being treated with corticosteroid therapy are at risk for a number of adverse effects (see

BOX 20.2 Dental Management Considerations in Patients With Rheumatoid Disorders

<p>P Patient Evaluation and Risk Assessment (See Box 1.1)</p> <ul style="list-style-type: none"> Evaluate and determine whether rheumatoid or joint disorder exists. Obtain medical consultation if disease is poorly controlled or undiagnosed or if the diagnosis is uncertain. 		<p>C</p> <p>Chair position Ensure comfortable chair position. Consider shorter appointments, and use supports as needed (e.g., pillows, towels).</p>	
<p>Potential Issues and Factors of Concern</p> <p style="text-align: center;">A</p>		<p>D</p> <p>Devices Patients who have a prosthetic joint replacement should be managed according to ADA (2003) guidelines (see Boxes 20.3 and 20.4).</p> <p>Drugs Obtain blood cell count with differential if surgery is planned for patients taking gold salts, penicillamine, antimalarials, or immunosuppressives. If patient is taking corticosteroids—secondary adrenal suppression is possible (see Chapter 15).</p>	
<p>Analgesics If patient is taking aspirin or another NSAID or acetaminophen, be aware of dosing and the possibility that pain may be refractory to some analgesics; dosing and analgesic choices may need to be modified in consultation with the physician.</p> <p>Antibiotics Provide antibiotic prophylaxis if needed in accordance with ADA (2015) guidelines (see Boxes 20.3 and 20.4).</p> <p>Anesthesia No issues</p> <p>Allergy Allergic reactions or lichenoid reactions are possible in patients taking many medications.</p> <p style="text-align: center;">B</p>		<p>E</p> <p>Equipment No issues</p> <p>Emergencies If surgery is performed, supplemental techniques may be necessary to control bleeding.</p>	
<p>Bleeding Excessive bleeding may occur if major surgery is performed on patients who take aspirin or other NSAIDs. Bleeding usually is not clinically significant and can be controlled with local hemostatic measures.</p> <p>Blood pressure No issues</p>		<p>F</p> <p>Follow-up Monitor dental and periodontal health; routine follow-up evaluation is appropriate.</p>	

ADA, American Dental Association; NSAID, nonsteroidal antiinflammatory drug.

Table 20.3), including adrenal suppression (see Chapter 15).^{11,20,21}

Late Prosthetic Joint Infection

Rarely, patients who have had a joint replaced may acquire an infection of the artificial joint. It appears that wound contamination or skin infection (staphylococci) is the source of the vast majority of late prosthetic joint infections (LPJIs).^{23,24} Only a few cases of LPJI have been remotely associated with bacteria (streptococci) found in the oral cavity. Most of these infections were more likely to result from physiologically occurring bacteremia or bacteremia caused by acute or chronic infection rather than from invasive dental procedures.^{23,24} Unfortunately, many orthopedic surgeons have persisted in requesting that patients continue to receive antibiotic prophylaxis for all dental procedures despite the lack of evidence.^{23,24}

In 2012, a panel of experts convened by the American Dental Association Council on Scientific Affairs developed an evidence-based clinical practice guideline (CPG) on the use of prophylactic antibiotics in patients with prosthetic joints who are undergoing dental procedures. This CPG is intended to clarify the “Prevention of Orthopaedic Implant Infection in Patients Undergoing Dental Procedures: Evidence-based Guideline and Evidence Report,” which was developed and published by the American Academy of Orthopaedic Surgeons and the American Dental Association.²⁵ The 2014 panel based the current CPG on literature search results and direct evidence contained in the comprehensive systematic review published by the 2012 panel, as well as the results from an updated literature search.²⁶ The 2014 panel identified four case-control studies. The 2014 panel judged that the current best evidence failed to demonstrate an association between dental procedures and prosthetic joint infection (PJI).²⁶ This panel also presented information about antibiotic resistance, adverse drug reactions, and costs associated with prescribing antibiotics for PJI prophylaxis. The panel made the following clinical recommendation:

*In general, for patients with prosthetic joint implants, prophylactic antibiotics are not recommended prior to dental procedures to prevent prosthetic joint infection. The practitioner and patient should consider possible clinical circumstances that may suggest the presence of a significant medical risk in providing dental care without antibiotic prophylaxis, as well as the known risks of frequent or widespread antibiotic use. As part of the evidence-based approach to care, this clinical recommendation should be integrated with the practitioner’s professional judgment and the patient’s needs and preferences.*²⁶

An important study by Berbari and colleagues²⁷ evaluated both preoperative and postoperative factors associated with PJI. The most clinically relevant of these factors were postoperative, especially wound drainage after

arthroplasty (odds ratio [OR], 1/4 18.7; 95% confidence interval [CI], 7.4–47.2). Other postoperative factors associated with PJI were wound hematoma after arthroplasty (OR, 1/4 2.5; 95% CI, 1.3–9.5) and postoperative urinary tract infection (OR, 1/4 2.7; 95% CI, 1.04–7.1). The OR for surgical site infection could not be calculated because there were no PJIs among the control participant. Thus, the patients at the highest risk of developing PJI had drainage, an infection, or both after undergoing arthroplasty. There were no data regarding whether use of prophylactic antibiotics decreased the risk of developing PJIs in patients with these specific postoperative conditions.²⁷ Other conditions, as defined by Berbari and colleagues,²⁷ with significant ORs (ranging from 1.8 to 2.2) for PJI independent of dental procedures, were preoperative factors that included prior operation or arthroplasty on the index joint, diabetes mellitus, and being immunocompromised (defined as RA, current use of systemic steroids or immunosuppressive drugs, diabetes mellitus, presence of a malignancy, or a history of chronic kidney disease).²⁷

2015 Summary of American Dental Association and the American Academy of Orthopedic Surgeons²⁶

In January 2015, the results of this task force along with rationale and clinical guidelines were published in the *Journal of the American Dental Association*.²⁶ Table 20.5 summarizes the recommendations for the management of patients with prosthetic joints who are undergoing dental procedures.

The joint task force recommends that in general, **patients with prosthetic joints ARE NOT recommended to receive prophylactic antibiotics before dental treatment.**²⁶

As with any recommendations, certain caveats and exceptions must be taken into account in making the decision to prescribe prophylactic antibiotics before dental treatment. Those factors may include other systemic comorbid conditions that may render the individual patient susceptible to infection, prior or existing infection of the prosthetic joint, and so on. Box 20.3 lists some of the **comorbid medical conditions that may increase the risk for prosthetic joint infection.**²⁶ Therefore, a careful, comprehensive review of the patient’s medical conditions and status and possible consultation with the physician may be in order.²⁶

A further recommendation in this paper was: “In cases where antibiotic prophylaxis is deemed necessary by the orthopedic surgeon, it is appropriate for them to recommend the appropriate antibiotic and when reasonable, to write the prescription....”

These recommendations (including this particular paper) are intended to provide rational insight and guidance to the individual dental practitioner to exercise good clinical judgment and to make the best treatment decisions for the individual patient.²⁶

TABLE 20.5 Management of Patients With Prosthetic Joints Undergoing Dental Procedures**Clinical Recommendation:**

In general, for patients with prosthetic joint implants, prophylactic antibiotics are *not* recommended before dental procedures to prevent prosthetic joint infection.

For patients with a history of complications associated with their joint replacement surgery who are undergoing dental procedures that include gingival manipulation or mucosal incision, prophylactic antibiotics should only be considered after consultation with the patient and orthopedic surgeon.* To assess a patient's medical status, a complete health history is always recommended when making final decisions regarding the need for antibiotic prophylaxis.

Clinical Reasoning for the Recommendation:

- There is evidence that dental procedures are not associated with prosthetic joint implant infections.
- There is evidence that antibiotics provided before oral care do not prevent prosthetic joint implant infections.
- There are potential harms of antibiotics, including risk for anaphylaxis, antibiotic resistance, and opportunistic infections such as *Clostridium difficile*.
- The benefits of antibiotic prophylaxis may not exceed the harms for most patients.
- The individual patient's circumstances and preferences should be considered when deciding whether to prescribe prophylactic antibiotics prior to dental procedures.

*In cases in which antibiotics are deemed necessary, it is most appropriate that the orthopedic surgeon recommend the appropriate antibiotic regimen and when reasonable write the prescription. Adapted from Sollecito TP, Abt E, Lockhart PB, et al: The use of prophylactic antibiotics prior to dental procedures in patients with prosthetic joints: evidence-based clinical practice guideline for dental practitioners—a report of the American Dental Association Council on Scientific Affairs, *J Am Dent Assoc* 146(1):11-16, 2015.

Box 20.4 gives the suggested antibiotic regimens when prophylaxis is indicated.²⁶ Because of the risk of potential complications, it is best to defer elective dental treatment for at least 30 days after a total joint replacement.¹⁸

Treatment Planning Modifications

Treatment planning modifications are dictated by the patient's physical disabilities. RA is a progressive disease that ultimately may lead to severe disability and crippling in some patients, which can make providing dental care difficult. Therefore, the dentist should be diligent in providing ongoing preventive care and should attempt to identify and treat or eliminate potential problems before the disease progresses.

Disabled patients may have significant difficulty cleaning their teeth.²⁸ Cleaning aids such as floss holders, toothpicks, irrigating devices, and mechanical toothbrushes may be recommended. If replacement of missing teeth is desired, consideration should be given to fabrication of a removable prosthesis because of the decreased chair time needed for

BOX 20.3 High-Risk Patients With Prosthetic Joints**Immunocompromised or Immunosuppressed Patients**

- Inflammatory arthropathies: rheumatoid arthritis; systemic lupus erythematosus; disease-, drug-, or radiation-induced immunosuppression

Other Patients

- Insulin-dependent (type 1) diabetes
- First 2 years after joint replacement
- Previous prosthetic joint infections
- Malnourishment
- Hemophilia

BOX 20.4 Suggested Antibiotic Prophylaxis Regimens**Patients Not Allergic to Penicillin: Cephalexin, Cefradine, or Amoxicillin**

- 2 g orally 30 minutes to 1 hour before the dental procedure

Patients Not Allergic to Penicillin and Unable to Take Oral Medications: Cefazolin or Ampicillin

- Cefazolin 1 g *or* ampicillin 2 g intramuscularly or intravenously 30 minutes to 1 hour before the dental procedure

Patients Allergic to Penicillin: Clindamycin

- 600 mg orally 30 minutes to 1 hour before the dental procedure

Patients Allergic to Penicillin and Unable to Take Oral Medications: Clindamycin

- 600 mg intravenously 30 minutes to 1 hour before the dental procedure

mouth preparation and the ease of cleaning of the appliance. If a fixed prosthesis is desired, the realistic potential to keep it clean must be a significant factor in design.²⁸

A patient with marked systemic disability or limited or painful jaw function because of TMJ involvement should not be subjected to prolonged or extensive treatment, such as complicated crown and bridge procedures.²⁸

Oral Complications and Manifestations

The most significant complication of the oral and maxillofacial complex in RA is TMJ involvement, which is found in up to 45% to 75% of patients with RA.²⁹ This may present as bilateral preauricular pain, tenderness, swelling, stiffness, and decreased mobility of the TMJ, or it may be asymptomatic. Periods of remission and exacerbation may occur, as with other joint involvement. Fibrosis or bony ankylosis can occur; therefore, treatment should be initiated promptly.²⁹ Clinically, patients may present with tenderness over the lateral pole of the condyle, crepitus, and limited opening. Radiographic changes

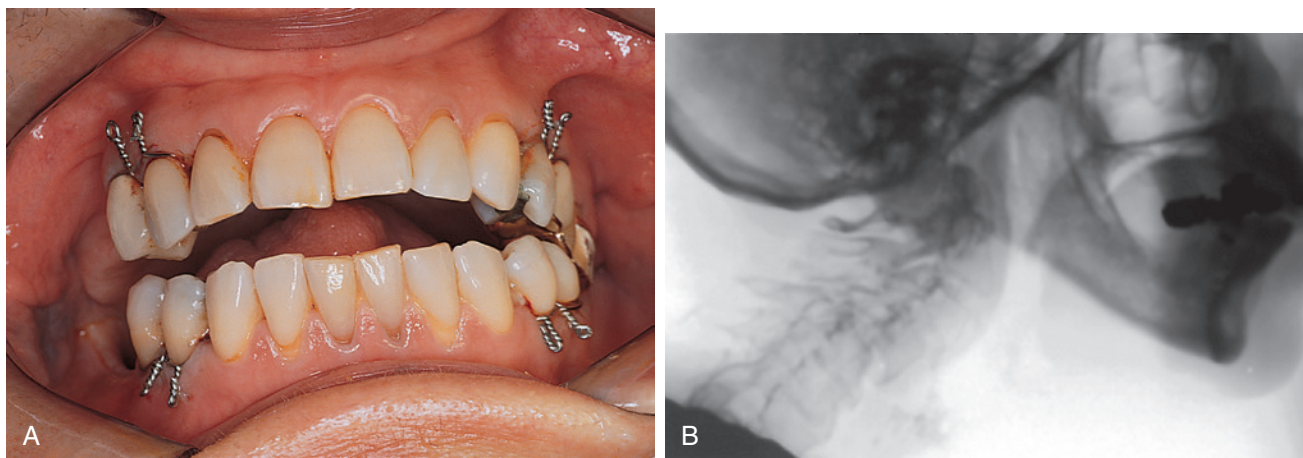

FIG 20.4 **A**, Anterior open bite resulting from progressive bilateral condylar resorption in a patient with advanced rheumatoid arthritis. **B**, Lateral skull film shows a swan-neck deformity. (From Quinn PD: *Color atlas of temporomandibular joint surgery*, St. Louis, 1998, Mosby.)

initially may show increased joint space caused by inflammation in the joint. Later, these inflammatory changes progress to erosive degenerative changes and changes in size and shape of the joint and can involve both the condyles and the fossa.²⁹

A potential dental complication is the development of an anterior open bite, caused by destruction of the condylar heads and loss of condylar height (Fig. 20.4).²⁹ Although palliative treatment such as interocclusal splints, physical therapy, and medication may prove to be helpful, surgical intervention can become necessary to decrease pain, improve appearance, or restore function.²⁹

There is recent evidence that patients with RA have a higher incidence of periodontal disease.³⁰ Therefore, meticulous oral hygiene combined with more frequent dental prophylaxis will be more effective in reducing periodontal problems. An additional complication that may be seen in patients with RA is severe stomatitis that occurs after the administration of drugs such as gold compounds, penicillamine, or immunosuppressive agents.³¹ Stomatitis may be an indication of drug toxicity and should be reported to the physician. Treatment for this problem should include consideration for changing the offending drug and palliative mouth rinses, diphenhydramine elixir, or a topical emollient such as Orabase (see Appendix C).³¹

OSTEOARTHRITIS

DEFINITION

Another of the rheumatic diseases, OA, also called degenerative joint disease, is the most common form of arthritis. Almost everyone older than 60 years of age develops OA to some degree.³² Most affected persons are minimally symptomatic; however, approximately 17 million people in the United States have OA to the extent that

it results in pain. OA is the leading cause of disability within the elderly population.³²

Osteoarthritis usually affects often-used joints such as hips, knees, feet, spine, and hands. The TMJ also may be affected. Women are affected twice as often as men; however, men are affected at an earlier age. It is generally a disease of middle to older age, first appearing after 40 years of age. Racial differences have been noted in the prevalence of OA and in the pattern of joint involvement.³³

ETIOLOGY

Although the exact cause of OA is not known, it has been thought to result from normal wear and tear on joints over a long period. However, other factors are now believed to be of significance. Preexisting structural joint abnormalities, intrinsic aging, metabolic factors, genetic predisposition, obesity leading to overloaded joints, and macrotrauma or microtrauma are considered causative or contributory factors in the origin of the disease.³²⁻³⁴

Epidemiology

It is estimated that 12% of the U.S. population has OA.² The prevalence of OA increases with age and is more common in women than men.³²

PATHOPHYSIOLOGY AND COMPLICATIONS

In the early stages of the disease, the articular cartilage actually becomes thicker than normal, and water content and the synthesis of proteoglycans are increased.³²⁻³⁴ This reflects a repair effort by the chondrocytes and may last for several years. Ultimately, however, the joint surface thins, and proteoglycan concentration decreases, leading to softening of the cartilage. Progressive splitting and abrasion of cartilage down to the subchondral bone occur.

The exposed bone becomes polished and sclerotic, resembling ivory (eburnation).³²⁻³⁴ Some resurfacing with cartilage may occur if the disorder is arrested or stabilized. New bone forms at the margin of the articular cartilage in the non-weight-bearing part of the joint, creating osteophytes (or spurs), often covered by cartilage, that augment the degree of deformity.³²⁻³⁴

In contrast with RA, OA generally has a more favorable prognosis and less serious complications, depending on the joint or joints involved.³²⁻³⁴ The two most important complications associated with OA are pain and disability. Although RA is a more serious disease, OA has a 30-fold greater economic impact, resulting in 68 million lost workdays per year compared with 2 million for RA.^{2,32} One form of OA, called *primary generalized osteoarthritis*, is characterized by involvement of three or more joints or groups of joints. It occurs most often in women and affects the hands, knees, hips, and spine.³²⁻³⁴

CLINICAL PRESENTATION

The primary symptom of OA is pain, typically localized to one or two joints (see [Table 20.2](#)). The pain is described as a dull ache accompanied by stiffness that is typically worse in the morning or after a period of inactivity. The pain and stiffness usually last no longer than 15 minutes. Joint noises or grinding sounds (crepitus) may be detected with movement.³²

The most common sign of OA is appearance of painless bony growths on the medial and lateral aspects of the PIP joints, called Heberden nodes. When these enlargements occur on the distal interphalangeal joints, they are called Bouchard nodes ([Fig. 20.5](#)). On occasion, some pain may be associated with these nodes.³² Redness and swelling are uncommon.³²

Depending on which joint or group of joints is involved, patients may experience varying degrees of incapacitation. Hip and knee joints are particularly troublesome and are a common source of disability.³²

Radiographic signs of OA include narrowing of the joint space, articular surface irregularities and remodeling,



FIG 20.5 Heberden nodes and Bouchard nodes in osteoarthritis. (From Swartz MH: *Textbook of physical diagnosis: history and examination*, ed 6, Philadelphia, 2010, Saunders.)

and osteophytes or spurs. In addition, subchondral sclerosis (eburnation) and ankylosis may be seen. Symptoms often are not well correlated with radiographic signs.³²

Laboratory and Diagnostic Findings

Laboratory findings in OA are essentially unremarkable. The ESR usually is normal, except for a mild elevation in primary generalized cases.³²

MEDICAL MANAGEMENT

The management of patients with OA is palliative, and for the most part, drug therapy is limited to analgesics. Acetaminophen frequently is effective in the management of OA and is recommended as a first-line drug. Aspirin or NSAIDs also are commonly used when acetaminophen is not effective (see [Table 20.3](#)).¹¹ Narcotic analgesics are generally used only for acute flares for short periods. Intraarticular steroid injections also may be used for acute flares for short periods. Intraarticular steroid injections may be used intermittently to reduce acute pain and inflammation. Patient education, physical therapy, exercise, weight reduction, and joint protection are all important aspects of management. Surgery, including joint replacement, may be required to improve function or relieve pain. See previous section under RA for prosthetic joint replacement.¹⁷

DENTAL MANAGEMENT

Dental management and treatment planning modifications are essentially the same as for patients with RA (see [Box 20.2](#)).

Oral Complications and Manifestations

The TMJ may be affected and TMJ pain caused by OA may occur.³⁵ [Fig. 20.6](#) shows osteoarthritic changes in the TMJ. The usual finding in patients with OA of the TMJ is insidious onset of unilateral preauricular aching and pain with stiffness after a period of inactivity that decreases with mild activity.³⁵ Severe pain may be elicited on wide opening, and pain occurs with normal function and worsens during the day.³⁵ Adjacent muscle splinting and spasm may occur. Crepitus is a common finding in the affected joint. In most cases, osteoarthritic pain in the TMJ resolves within 8 months of onset. Radiographic changes include decreased joint space, sclerosis, remodeling, and osteophytes (see [Fig. 20.6](#)). No correlation exists between TMJ symptoms and radiographic or histologic signs of OA.³⁵

There is a relationship between TMJ disk displacement and OA.³⁵ Most patients with disk displacement, whether reducing or nonreducing, can be treated successfully with conservative, reversible therapies.³⁵

Treatment of OA of the TMJ consists of acetaminophen, aspirin or NSAIDs, muscle relaxants, approaches to limit jaw function, physical therapy (heat, ice, ultrasound,



FIG 20.6 Osteoarthritic changes in the temporomandibular joint.

controlled exercise), and occlusal splints to decrease joint loading. Conservative therapy is successful in controlling symptoms in most cases; however, if pain or dysfunction is severe and persistent, TMJ surgery may be necessary.³⁵

SYSTEMIC LUPUS ERYTHEMATOSUS

DEFINITION

There are two types of lupus erythematosus (LE): discoid (DLE), which predominantly affects the skin, and a more generalized systemic form (SLE), which affects multiple organ systems. DLE is characterized by chronic, erythematous, scaly plaques on the face, scalp, or ears. Most patients with DLE have very few systemic manifestations, and the course tends to be benign. SLE involves the skin and many other organ systems and is the more serious form.^{36,37} This section focuses on SLE.

Etiology

Systemic lupus erythematosus is an autoimmune disease of unknown etiology. A strong familial aggregation exists, with a much higher frequency noted among first-degree relatives of patients.^{36,37} Studies of patients with SLE suggest that the disease is caused by genetically determined immune abnormalities that can be triggered by exogenous and endogenous factors. Among these triggering factors are infectious agents, stress, diet, toxins, drugs, and sunlight.^{36,37}

Epidemiology

Systemic lupus erythematosus is a prototypical autoimmune disease that predominantly affects women of childbearing age with a female-to-male ratio of 6:1 to 10:1. The disease is more common and more severe among African Americans and Hispanics compared with whites.^{36,37} A defining feature of SLE is the presence of antibodies

directed against one or more components of cell nuclei (antinuclear antibodies [ANAs]), with certain disease manifestations associated with the presence of one or more of these different ANAs.^{36,38}

PATHOPHYSIOLOGY AND COMPLICATIONS

In SLE, antibody and immune complex deposition lead to inflammation and vasculopathy.^{36,37} Circulating autoantibodies form antigen–antibody complexes, which are deposited in a wide variety of tissues and organs, including the kidneys, skin, blood vessels, muscles and joints, heart, lungs, brain, gastrointestinal tract, lymphatics, and eyes.^{36,37}

Despite advances in diagnosis and management, complications attributable to SLE or its treatment continue to cause substantial morbidity. Complications of SLE include infection, coronary artery disease, renal and pulmonary disease, and osteonecrosis.^{36,37}

Several studies have documented substantial improvement in the survival of patients with SLE, with 5-year survival rates of 90% or greater and 10-year survival rates of more than 80%. The leading causes of death in patients with SLE are infectious complications and clinical manifestations related to lupus itself, such as acute vascular neurologic events, renal failure, and cardiovascular or pulmonary involvement.^{36,37}

Clinical Presentation

Because of the widespread systemic involvement of SLE, multiple manifestations are observed in many tissues and organs.^{36,39} The typical presentation is a woman with polyarthritis and a butterfly-shaped erythematous rash across the nose and cheeks (Fig. 20.7). The clinical presentation varies widely from mild to severe and depends largely on the extent and type of organ involvement.^{36,38}

Arthritis is the most common manifestation of SLE, affecting nearly three quarters of patients.^{36,38} It affects the small joints and is migratory, with the pain typically out of proportion compared with clinical signs. The classic butterfly malar rash is found in approximately one third of patients with SLE, with rash on the upper trunk or other areas of exposed skin being more common.^{36,38}

Serious renal abnormalities occur in fewer than one third of patients with SLE. Renal failure, one of the most serious problems, is the best clinical indicator of a poor prognosis.^{36,38} Autoimmune hepatitis may occur with SLE, but of course it is not transmissible. However, it may result in liver damage (see Chapter 10).³⁷

Neuropsychiatric symptoms are common and include organic brain syndrome, psychosis, seizures, stroke, movement disorders, and peripheral neuropathy. Thromboembolism associated with antiphospholipid antibody is an important cause of abnormalities in the central nervous system.^{36,37}

Pulmonary manifestations of SLE include pleuritis, infection, pulmonary edema, pneumonitis, and pulmonary hypertension.^{36,37} Cardiac involvement is common and

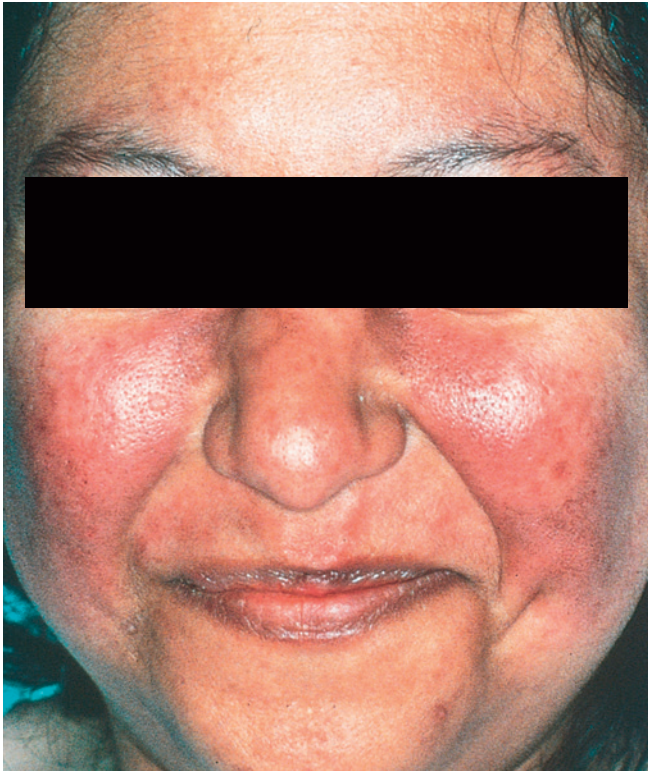

FIG 20.7 Characteristic butterfly-shaped rash of systemic lupus erythematosus. (From Ignatavicius D, Workman ML: *Medical-surgical nursing: patient-centered collaborative care*, ed 6, St. Louis, 2010, Saunders.)

consists of pericarditis, myocarditis, endocarditis, and coronary artery disease. Valvular abnormalities can be identified by echocardiography in 25% of patients but rarely result in serious valvular dysfunction.^{36,37} However, Libman-Sacks endocarditis (nonbacterial verrucous endocarditis) is found at autopsy in 50% of patients with SLE.^{36,37} Approximately 4% of patients with SLE have cardiac valve abnormalities that place them in the moderate risk group for endocarditis.^{36,37} However, no cases demonstrated a relationship between endocarditis and SLE.

Laboratory and Diagnostic Findings

The ANA test is the best screening test for SLE because it yields a positive result in 95% of patients.^{36,37} A positive result also occurs in patients with other rheumatic diseases. Results of anti-DNA assays—double helix and single helix—also are elevated in 65% to 80% of patients with active untreated SLE.^{36,37}

Hematologic abnormalities include hemolytic anemia, leukopenia, lymphopenia, and thrombocytopenia. Leukopenia in SLE usually is not associated with recurrent infection. Autoimmune thrombocytopenia occurs in as many as 25% of patients with SLE and may be severe.^{36,37}

A variety of clotting abnormalities may be seen; the most common of these is the lupus anticoagulant, which is associated with elevated partial thromboplastin time (PTT).^{36,37} This can indicate the presence of

antiphospholipid antibodies. These antibodies may be useful in the diagnosis of SLE but are not 100% accurate and can result in false-positive results. This can result in thromboembolic events rather than increased bleeding, and invasive surgery may be performed without correction of this laboratory abnormality. The ESR often is elevated, but this does not reflect disease activity.^{36,37} With active nephritis, proteinuria is present, as are hematuria and cellular or granular casts.^{36,37}

Medical Management

Treatment for patients with SLE uses many of the medications used in the treatment other rheumatologic disorders (see [Table 20.3](#)) but with a greater degree of observation for renal, cardiac, and clotting abnormalities.^{36,37} Patients with SLE are advised to avoid sun exposure because this may trigger onset or exacerbation of the disease. Aspirin and NSAIDs are often used for mild disease, antimalarials for dermatologic disease, glucocorticoids for more severe symptoms, and cytotoxic agents for symptoms unresponsive to other therapies or as adjuncts in severe disease.^{36,37}

A specific set of quality indicators (QIs) to evaluate the monitoring of SLE patients in routine clinical practice has been developed recently.³⁹ These QIs have been integrated into the recently developed European League Against Rheumatism (EULAR) recommendations for monitoring SLE patients in routine clinical practice and observational studies. Eleven QIs have been developed referring to the use of validated activity and damage indices in routine clinical practice, general evaluation of drug toxicity, evaluation of comorbid conditions, eye evaluation, laboratory assessment, evaluation of the presence of chronic viral infections, documentation of vaccination, and antibody testing at baseline. A disease-specific set of quality assessment tools should help physicians deliver high-quality care across populations of patients with SLE.³⁹

DENTAL MANAGEMENT

Because SLE is such a varied disease with so many potential problems caused by the disease or its treatment, pretreatment consultation with the patient's physician is advised ([Box 20.5](#)). As in RA, drug considerations and adverse effects in SLE are of major importance. [Table 20.3](#) lists the dental and oral considerations associated with the use of these drugs.^{6,37} The leukopenia that is common in SLE usually is not associated with a significant increase in infection; however, when combined with corticosteroids or cytotoxic drugs, the likelihood of infection is increased.^{36,37} Therefore, in patients who are taking corticosteroids or cytotoxins who also have leukopenia, the use of prophylactic antibiotics for periodontal and oral surgical procedures may be considered. Patients who are taking corticosteroids also may develop significant adrenal suppression and could require supplementation, especially for surgical procedures or in cases of extreme anxiety^{6,37} (see [Chapter 15](#)).

BOX 20.5 Key Points in Dental Management of Patients With Systemic Lupus Erythematosus (also see [Chapter 12](#))

1. Consultation with physician
 - a. Patient status and stability
 - b. Extent of systemic manifestations (i.e., kidney, heart)
 - c. Hematologic profile: CBC with differential, PT, PTT
 - d. Drug profile
2. Drug considerations
 - a. Aspirin and NSAIDs: Bleeding may be increased but is not usually clinically significant; if patient is concurrently taking corticosteroids, bleeding is more likely.
 - b. Gold salts, antimalarials, penicillamine, and cytotoxic drugs may cause leukopenia and thrombocytopenia; also, severe stomatitis—treat symptomatically.
 - c. Corticosteroids may cause adrenal suppression.
3. Hematologic considerations
 - a. Leukopenia with corticosteroids or cytotoxic drugs may predispose patient to infection; use of postoperative antibiotics can be considered with surgical procedures.
 - b. Platelet count <50,000/ μL may result in severe bleeding; consult with physician.
 - c. Elevated PTT associated with lupus anticoagulant usually does not cause increased bleeding; surgery can be performed.
4. Infective endocarditis is a potential problem—antibiotic prophylaxis is not recommended by the American Heart Association.

CBC, Complete blood cell count; *NSAID*, nonsteroidal antiinflammatory drugs; *PT*, prothrombin time; *PTT*, partial thromboplastin time.

Abnormal bleeding caused by thrombocytopenia is a potential problem in some patients with SLE.⁴⁰ Therefore, a platelet count and PTT should be obtained. A platelet count lower than 50,000/mL may indicate inadequate platelet activity and potential bleeding problems. Other abnormalities should be discussed with the physician. Typically, an elevated PTT associated with the lupus anticoagulant is not a risk factor for increased bleeding.^{36,37}

Cardiac valvular abnormalities are found in 25% to 50% of patients with SLE and often are not clinically detectable; the potential exists for bacterial endocarditis resulting from physiologic bacteremia. The American Heart Association's 2007 guidelines for endocarditis prevention do not recommend antibiotic prophylaxis for patients with valvular disease associated with SLE when receiving invasive dental procedures. Finally, patients with SLE-associated renal failure have the potential for altered drug metabolism, hematologic disorders, and infection (see [Chapter 12](#)).

TREATMENT PLANNING CONSIDERATIONS

Specific dental treatment planning modifications are not required. However, consideration should be given to

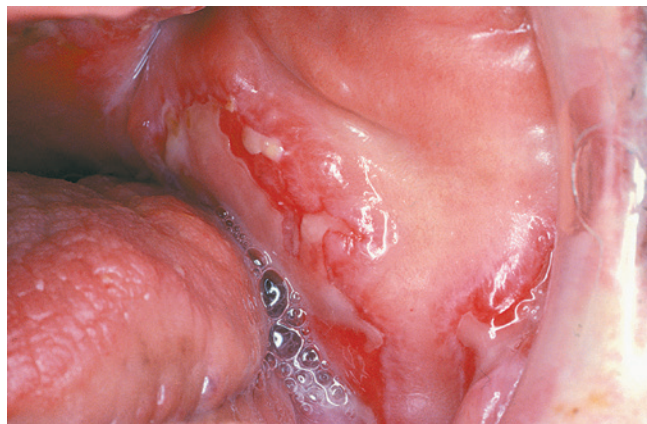

FIG 20.8 Ulceration of the buccal mucosa in a patient with systemic lupus erythematosus. (From Neville BW, Damm D, Allen C, et al: *Oral and maxillofacial pathology*, ed 3, St. Louis, 2009, Saunders.)

physical disabilities related to arthritis and myalgia. Additionally, systemic complications such as renal impairment and cardiac problems such as arrhythmia and valvular defects may occur. For patients with SLE, the establishment and maintenance of optimal oral health are of paramount importance.

Oral Complications and Manifestations

Oral lesions of the lips and mucous membranes have been reported to occur in up to 5% to 25% of patients with SLE.⁴¹ These lesions are rather nonspecific and may be erythematous with white spots or radiating peripheral lines; they also may occur as painful ulcerations ([Fig. 20.8](#)). Lesions frequently resemble lichen planus or leukoplakia. When they occur on the lip, a silvery, scaly margin, similar to that seen on the skin, may develop. Skin and lip lesions frequently are noted after exposure to the sun. Treatment of these lesions is symptomatic, and future sun exposure is avoided (see [Appendix C](#)).⁴¹ Other oral manifestations of SLE may include xerostomia and hyposalivation, dysgeusia, and glossodynia. The dentist should always remain alert to oral eruptions and lesions associated with medications used to treat patients with SLE because the eruptions may be a sign of drug toxicity.⁴²

SJÖGREN SYNDROME

DEFINITION

Sjögren syndrome is an autoimmune disease complex classified among the many rheumatic diseases that causes exocrinopathy and affects the salivary and lacrimal glands. SS is characterized by a triad of clinical conditions that consists of keratoconjunctivitis sicca, xerostomia, and a connective tissue disease (usually RA).^{40,43} SS manifests in two different forms: primary SS and secondary

SS. Primary SS (SS-1) manifests clinically with the primary ocular complication of keratoconjunctivitis sicca; in the oral cavity, it is associated with various levels of salivary gland dysfunction (xerostomia). Secondary SS (SS-2) manifests as the presence of keratoconjunctivitis sicca or xerostomia in the presence of a diagnosed systemic connective tissue disease.^{40,43} The connective tissue disorder from which SS develops most commonly is RA; SLE, primary biliary cirrhosis, FM, mixed connective tissue disease, polymyositis, Raynaud syndrome, and several others are among the associated inflammatory conditions.^{40,43}

Epidemiology

The prevalence of SS in the adult population is estimated to be around 2.7%.⁴⁴ Today, the prevalence of SS in the United States is estimated at more than 2.5 million. SS has now become the second most common rheumatoid disorder.⁴⁴ Originally named for an ophthalmologist from Sweden, SS has been reported in nearly every major country, and the geographic distribution of cases, although accurate data are lacking, appears to be relatively uniform. SS is primarily a disease of women—more than 90% of all patients with SS are female.^{40,42-45}

Sjögren syndrome typically manifests during the fourth or fifth decade of life, although the condition usually progresses insidiously over several years, often remaining unrecognized. Therefore, some affected persons may exhibit clinical SS at a much earlier age than when it is actually diagnosed. Isolated cases of SS have been reported in children.^{40,42,43}

Etiology

The precise cause of SS, as of many of the autoimmune rheumatic disorders, is unknown, although several contributing factors have been identified. One theory is that the disease results from complications of viral infection with Epstein-Barr virus (EBV).⁴⁵ Exposure to or reactivation of EBV elicits expression of the human lymphocyte antigen (HLA) complex; this is recognized by the T cell (CD4+) lymphocytes and results in the release of cytokines (TNF, IL-2, interferon- γ [IFN- γ], and others).⁴⁶ Current evidence has shown that both innate and adaptive genetic alteration are involved in SS.⁴⁶ Chronic inflammation, infiltration of lymphocytes, and ultimate destruction of exocrine gland tissue follow.^{44,45}

PATHOPHYSIOLOGY AND COMPLICATIONS

Sjögren syndrome is a chronic, progressive autoimmune disorder that is characterized by exocrinopathy and generalized lymphoproliferation that primarily affect the salivary and lacrimal glands.^{40,43} Systemic manifestations include involvement of the pancreas, biliary tract, and lungs. A genetic marker, HLA-DR4, has been identified as specific for SS.^{43,44} Activation of the interferon pathway is important in SS.⁴⁵

Labial salivary gland histopathologic examination has been accepted almost universally as the *prima facie* diagnostic indicator for definitive diagnosis of SS.^{43,44} The classic histopathologic feature of the minor salivary glands in SS is seen as lymphocytic infiltration that includes benign lymphosialadenopathy (focal lymphocytic sialadenitis or benign lymphoepithelial lesion in the major salivary glands).^{43,44} This benign lymphosialadenopathy may manifest as parotid hypertrophy, particularly in patients with primary SS. Small clusters of intralobular ducts enlarge to replace the acinar epithelial parenchyma. The lesion comprises primarily CD4+ T cell lymphocytes, along with polyclonal B cells and plasma cells that are acquired late. Among the lymphocytic foci, approximately 75% are T cells, and 5% to 10% are B cells. As the inflammatory process progresses, fibrosis and atrophy of the salivary glands occur, and hyposalivation progresses.^{43,44}

Progression to lymphoma occurs in about 5% of SS patients.^{47,48} It occurs in patients with SS-1 with chronic parotid enlargement; whether patients had other cancers or had undergone radiation therapy or chemotherapy (then the relative risk may be as high as 100 times greater) was considered^{43,44} (see [Chapter 23](#)). Clinical findings associated with lymphoma (see [Chapter 23](#)) include anemia, cryoglobulinemia, lymphopenia, cutaneous vasculitis, and peripheral neuropathy. Lymphadenopathy is common (86%) and is associated with enlarged cervical and axillary nodes.^{43,44} Evidence suggests that initial transformation to lymphoma occurs in the salivary glands and that the presence of B cell monoclonality in labial minor salivary gland tissue is associated with progression to malignancy.⁴⁹

The most common type of lymphoma in patients with SS involves mucosa-associated lymphoid tissue (MALT); 70% of cases are low-grade, nonaggressive lymphomas, and 15% are the high-grade lymphoblastic type. IL-6 and TNF- α are associated with lesions that undergo transformation to lymphoma.⁴⁹

CLINICAL PRESENTATION

Sjögren syndrome is characterized by eye dryness, hyposalivation, and enlargement of the parotid glands. Secondary outcomes of persistent oral dryness are angular cheilosis, dysgeusia (taste dysfunction), secondary infection, and a significantly increased caries rate ([Table 20.6](#)).^{43,44}

Salivary Gland Dysfunction and Hyposalivation

Saliva in normal quantity and composition is rich in constituents that have potent antimicrobial, antacid, lubricative, and homeostatic properties. Saliva contains approximately 60 important protective constituents, including immunoglobulins, electrolytes, buffers, antimicrobial enzymes, digestive enzymes, and many others, all of which almost universally serve to make saliva an essential contributor to the health and homeostasis of the oral cavity.^{43,44} Obviously, when saliva is diminished

TABLE 20.6 Clinical Manifestations of Sjögren Syndrome*

Clinical Manifestation	Prevalence (% of Affected Patients)
Orcheilosis or angular cheilitis	75
Glossitis	60
Mucositis	30
Glossodynia	45
Dysgeusia	75
Dysphagia	45
Candidiasis	75
Dental caries	100
Periodontitis	60–100

*From 62 consecutive patients with Sjögren syndrome who presented to the University of Minnesota Xerostomia Clinic.

Data from Rhodus NL: Xerostomia and glossodynia in patients with autoimmune disorders, *Ear Nose Throat J* 68:791-794, 1989 and Rhodus NL, Colby S, Moller K, Bereuter J: Quantitative assessment of dysphagia in patients with primary and secondary Sjögren's syndrome, *Oral Surg Oral Med Oral Pathol Oral Radiol Endod* 79:305-310, 1995.

in quantity or altered in composition, as in SS, deterioration of oral soft and mineralized tissues may occur.^{43,44}

Patients with SS have difficulty tasting, tolerating, and swallowing certain foods.⁵⁰ Consequently, dietary intake of certain nutrients may be inadequate in these patients.⁵¹

Among its many beneficial constituents, saliva has been shown to be rich in proteins that have potent antifungal properties; thus, it plays an important role in host defense and protection from yeasts such as *Candida* spp. Therefore, with reduced salivary flow in patients with SS, *Candida* infections are very common.⁵² Studies also have shown that patients with SS more frequently exhibit periodontal disease, especially loss of clinical attachment.⁵³

Laboratory and Diagnostic Findings

Precise diagnostic criteria for SS remain controversial, although specific laboratory tests are available for the major diagnostic categories of salivary and tear production, histopathologic changes, and serologic inflammatory markers (Box 20.6). Several published criteria (e.g., ACR) are available for the diagnosis of SS with values that are slightly different. Common characteristics and variations are summarized in Box 20.6.^{44,47,48}

Hypergammaglobulinemia is the most frequent laboratory finding (80%) among patients with SS. Hyperactivity of B lymphocytes results in increased RF antibodies; ANAs; and antibodies against organ-specific antigens, such as salivary duct epithelia or thyroid tissue.^{44,47,48} ANAs make up the SS-A (Ro), which is present in approximately 70% of patients with SS-1 and 15% to 90% with SS-1 and SS-B (La) antibodies, which are present in approximately 50% of patients with SS-1 and 5% to 30% with SS-2.^{44,47,48,54} These ANAs also may be found in other autoimmune disorders. Elevated ESR, mild anemia ($\approx 25\%$), and leukopenia ($\approx 10\%$) also are found in patients with

BOX 20.6 Diagnostic Criteria for Sjögren Syndrome

Subjects must meet four of six criteria; labial biopsy or serologic studies must be performed.

Ocular Symptoms (1:3)	Ocular Signs (1:2)
Daily dry eyes >3 months	+ Schirmer test (<5 mm/5 min)
Sand or gravel sensitivity	Rose Bengal score (>4 vBs)
Use of tear substitutes (>3 times daily)	
Oral Symptoms (1:3)	Oral Signs: Salivary Function (1:3)
Daily dry mouth >3 months	+ Scintigraphy
Swollen salivary glands	+ Sialography
Need fluids to swallow food	WUSF <1.5 mL/15 min (0.1 mL/min)
Labial SG histology	Autoantibodies (1:2)
Focus scope biopsy $> \frac{1}{4}$ mm	anti-SS-Ro
>50 mononuclear cells per field	anti-SS-La

SG, Salivary gland; vBs, von Blisterberg score for eyes; WUSF, whole unstimulated saliva flow.

SS. The laboratory tests used to diagnose SS are summarized in Box 20.6).^{44,47,48,54}

Sialometry

Sialometry is useful as an initial screening tool for hyposalivation associated with SS and as an assessment for the level of severity of SS. To be valuable as a diagnostic technique, salivary flow collection must be performed over a period of at least 5 minutes (often up to 15 minutes).^{44,54}

DENTAL MANAGEMENT

Patient management for SS traditionally has been palliative and preventive because there is no known cure. Relief of the primary symptoms of dryness (oral and ocular) and the secondary burning and discomfort is the main goal. Restoration and maintenance of a normal homeostatic oral environment are secondary goals.^{43,44}

Therapy for the oral component of SS may be classified into three major categories:

1. Provision of moisture and lubrication by stimulation or simulation
2. Treatment of secondary mucosal conditions (such as mucositis or candidiasis)
3. Prevention of oral disease, provision of maintenance and general support (e.g., nutrition)^{43,44}

These therapeutic strategies are outlined in Table 20.7 and Appendix C.

Moisture and Lubrication

Patients with SS should be counseled to drink plenty of water (8–10 glasses per day) and to avoid diuretics such

TABLE 20.7 Management of Salivary Dysfunction*

General Measures	Specific Agents or Measures*†
MOISTURE AND LUBRICATION (CONTINUOUS, AS NEEDED)	
Drink (sip water, liquids)	Oasis, Salivart (or other artificial saliva), or moisturizers (especially at night)
Use sugarless candy or gum	
Avoid ethanol	Pilocarpine hydrochloride, 2% (5 mg three times daily)
Avoid tobacco	or
Avoid coffee, tea, and other caffeinated beverages	Cevimeline hydrochloride (Evoxac), 30-mg caps, three times daily Sodium carboxymethylcellulose, 0.5% solution
SOFT TISSUE LESIONS AND SORENESS (TREATMENT AND MAINTENANCE)	
Oasis, Salivart (or other artificial saliva), or moisturizers (especially at night)	Benadryl + Maalox + nystatin elixir‡ (Carafate, optional) (Lidocaine 2%, optional, for acute lesions) Decadron, 0.5 mg/5 mL elixir§ (for acute lesions) Triamcinolone 0.1% (in Orabase) (for acute lesions) Orabase-HCA (for acute lesions) Mycelex 60-mg troches (for candidiasis) Mycolog II ointment (lips and tongue)
PREVENTION OF CARIES AND PERIODONTAL DISEASE (CONTINUOUS)	
Meticulous perioral hygiene	Biotene toothpaste (neutral sodium fluoride, 1.0%, trays)
Avoid acids	Prevident, 5000 ppm¶
Regular hygiene and prophylaxis recalls	Peridex (chlorhexidine gluconate) (optional)
Sodium bicarbonate rinses (optional)	Waterpik

*Specific treatments are dependent on the diagnosis.

†Manufacturers: Oral Balance, Laclede Pharmaceuticals; Salagen, MGI Pharmaceuticals; Mouthkote, Parnell Pharmaceuticals; Optimoist, Colgate-Hoyt; Salivart, Gebauer; Biotene, Laclede Pharmaceuticals; Benadryl, Parke-Davis; Maalox, Novartis Pharmaceuticals; Carafate, Hoechst, Marion, Roussel Pharmaceuticals; Decadron, Merck & Co. Pharmaceuticals; Orabase, Colgate-Palmolive; Mycelex, ALZA Prevident, Colgate-Hoyte; Peridex, Procter & Gamble; Waterpik, Teledyne.

‡Benadryl, 25 mg/10 mL + Maalox, 64 mL + nystatin, 100,000 IU/mL = 16 mL.

§Decadron elixir, 0.5%/5 mL. Dispense 100 mL; to be swished and expectorated, 5 mL three times daily.

¶Prevident neutral sodium fluoride, 1.0%, to be applied in trays 2 times daily. Adapted from Rhodus NL: Diagnosis and treatment of Sjögren's syndrome, *Quintessence Int* 30:689-699, 1999.

as caffeine, tobacco, and alcoholic beverages. Obviously, certain medications (>400) may contribute to and compound the xerostomia, so some may need to be modified or avoided, if possible. Any changes in the patient's medication must be coordinated with the patient's

physician. Although salivary substitutes, oral moisturizers, and artificial salivas may provide some relief for the xerostomia experienced by patients with SS, by and large, they are inadequate. Most are compounds of carboxymethylcellulose or hydroxymethylcellulose and are too viscous or not viscous enough for most patients. The retentivity or longevity of their effect is very short-lived, and they provide little more relief than water. To date, these simulated salivas appear to provide little benefit to patients with SS.^{43,44} On the other hand, pharmacologic stimulation of the salivary glands can be quite successful. Pilocarpine HCl (Salagen) and cevimeline HCl (Evoxac) are effective for the treatment of patients with SS with signs and symptoms of hyposalivation.^{43,44}

Systemic administration of pilocarpine or cevimeline effectively stimulates only the salivary acinar tissue, which remains functional. Therefore, patients with SS who have lost most of the salivary acinar tissue capable of fluid production benefit little from these drugs.^{43,44}

Other pharmacologic sialagogues, such as bethanechol chloride, bromhexine, and anethole trithione, have been shown to stimulate salivary flow, but none has been approved by the U.S. Food and Drug Administration.

Oral Complications and Manifestations

One of the most significant oral complications of SS and xerostomia is the tremendous increased incidence of caries.^{44,54,55} Recommendations for patients with SS with dry mouth are as follows: Topical daily fluoride should be used in all patients. Although no study results link improved salivary flow to caries prevention, the oral health community generally accepts that increasing saliva may contribute to decreased caries incidence, so increasing saliva through gustatory, masticatory, or pharmaceutical stimulation should be considered. Chlorhexidine administered as varnish, gel, or rinse may be considered, and nonfluoride remineralizing agents may be considered as an adjunct therapy.⁵⁵

Among the oral symptoms most commonly associated with SS, aside from xerostomia, is glossodynia (burning tongue). The tongue often becomes depapillated and fissured and develops a scrotal appearance (Fig. 20.9).^{43,44} The dorsal epithelium often is atrophic or eroded, erythematous, and potentially secondarily infected. Pain and burning may be spontaneous or may be elicited with acidic or spicy foods, such as those containing ascorbic or acetic acid. The tongue is commonly infected (in as many as 83%) with *Candida albicans* in patients with SS.⁵² Not only must the acute candidal infection be treated, but some type of maintenance therapy must be provided to prevent recurrence of the fungal infection. As long as the oral environment is adversely affected by hyposalivation, susceptibility to recurrence of the oral infection and continued deterioration occur.⁵² Therefore, clinical follow-up evaluation and some phased maintenance therapy may be necessary. Generally, these oral mucosal conditions are treated as if they occurred independently (i.e., with

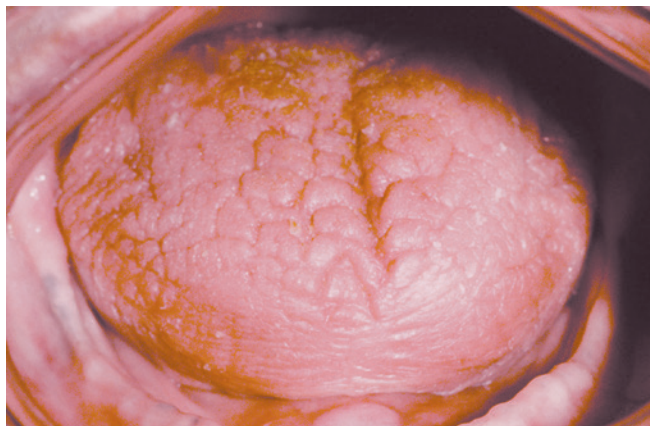

FIG 20.9 Dry and fissured tongue in a patient with Sjögren syndrome. (From Neville BW, Damm D, Allen C, et al: *Oral and maxillofacial pathology*, ed 3, St. Louis, 2009, Saunders.)

antifungal agents and topical antiinflammatory agents and including corticosteroids, analgesics, or anesthetics as indicated) (see [Table 20.5](#)).^{43,44}

Prevention and Maintenance

Patients with SS may have less than 5% of the normal quantity of saliva to protect the oral cavity.^{47,48} The risk for caries as well as enamel erosion then is extremely high. Of particular risk is the cervical–cementoenamel junction portion of the tooth. Meticulous oral hygiene with minimally abrasive fluoridated dentifrices and irrigation devices is paramount.^{43,44} In the xerostomic environment, abrasion of the tooth surface should be minimized as much as possible. Shorter professional hygiene recall intervals also are extremely important.^{43,44}

Frequent application of concentrated fluorides delivered as a direct brush-on treatment or with custom-made trays is imperative to prevent the rapid progression of caries (see [Table 20.5](#)).^{44,54,55}

PSORIATIC ARTHRITIS

DEFINITION

Psoriatic arthritis is an inflammatory arthritis associated with the inflammatory skin condition psoriasis. Although most cases arise in patients with established cutaneous disease, some patients (particularly children) have arthritis that antedates the appearance of the skin lesions. Although the extent of psoriatic skin disease correlates poorly with the development of arthritis, the risk for PsA increases with a family history of RA.⁵⁶

Epidemiology

Psoriatic arthritis is estimated to occur in 0.1% to 1.0% of the U.S. population.³⁵ PsA develops in 5% to 7% of patients with psoriasis.⁵⁶ The age at onset can range from 30 to 55 years, with an equal predilection for

women and men. Psoriatic spondylitis has a slight male preponderance.⁵⁶

Pathophysiology and Complications

The genetic associations with PsA are complex. Psoriasis itself is associated with HLA-B13, HLA-B16, HLA-B17, and HLA-Cw6. By contrast, HLA-B39 and HLA-B27 have been associated with sacroiliitis and axial involvement.^{56,57} No etiologic agent has been proved in PsA, although some investigators have proposed that the disease process represents RA in response to cutaneous bacteria.^{56,57} The histopathology of the synovitis of PsA is comparable to that of the other SpAs, with the absence of local production of immunoglobulin and RF being differentiating features from RA.^{56,57} There is the potential for aggressive osteolysis, fibrous ankylosis, and heterotopic new bone formation to occur in PsA. As mentioned earlier, the coexistence of human immunodeficiency virus (HIV) and PsA seems to set the stage for an aggressive course of joint destruction in some patients.^{56,57}

Psoriatic arthritis has a variable manifestation and disease course, but several clinical patterns have been identified. The clinical subsets are not mutually exclusive, nor are they static over time. The most common form, in which 30% to 50% of patients are affected, is an asymmetric oligoarthritis that may involve both large and small joints.^{56,57} In the second subset, there is selective targeting of the distal interphalangeal joints, seen in 10% to 15% of patients. These changes are strongly associated with nail dystrophy, of which the features are onycholysis, subungual keratosis, pitting, and oil drop–like staining ([Fig. 20.10](#)).^{56,57} The third subset (15%–30% of patients) has a symmetric polyarthritis that mimics RA in many ways except for the absence of rheumatoid nodules and RF. The fourth clinical variant is psoriatic spondylitis, which occurs in 20% of patients; 50% of such patients are HLA-B27 positive.^{56,57}

Finally, arthritis mutilans (5% of patients) is a destructive, erosive arthritis that affects large and small joints. It can be associated with marked deformities and significant disability.^{56,57} [Fig. 20.10](#) shows nail pitting in psoriasis. The pits are more discrete and regular compared with pits affecting the nail plate in dermatitis.^{56,57} Radiographic changes in PsA involve soft tissue swelling (particularly in the case of dactylitis), erosions, and periostitis. Axial involvement may lead to the appearance of asymmetric sacroiliitis with syndesmophytes that are bulky, asymmetric, and nonmarginal. The classic “pencil-in-cup” deformity may be seen in patients with distal interphalangeal joint disease or arthritis mutilans. Acroosteolysis is noted in a minority of patients and reflects an aggressive erosive process.^{56,57}

MEDICAL MANAGEMENT

Abatacept, a modified antibody, selectively inhibits T-cell activation via competitive binding to CD80 or CD86 and



FIG 20.10 Nail pitting in a patient with psoriatic arthritis. (From Goldman L, Ausiello D, editors: *Cecil textbook of medicine*, ed 23, Philadelphia, 2008, Saunders.)

decreases serum levels of cytokines and inflammatory proteins implicated in the pathogenesis of PsA.⁵⁸ Abatacept is an approved treatment for chronic inflammatory conditions such as RA and juvenile idiopathic arthritis, in which T cells are involved in the pathophysiologic progression of the disease.⁵⁸ Etanercept (Enbrel) is also used in treatment.

DENTAL MANAGEMENT

Dental management and treatment planning modifications for PsA are very similar to those for RA and are reviewed in [Box 20.2](#). The exception may be the skin involvement as well as the choice or combination of immunosuppressive drugs. Therefore, the dentist must make a careful assessment of the severity of disease and medical management of the patient's condition.

GIANT CELL ARTERITIS

DEFINITION

Giant cell arteritis is a systemic vasculitis involving medium-sized and large arteries, most commonly the extracranial branches of the carotid artery and specifically the temporal artery.⁵⁹ GCA (temporal arteritis) is the most common form of vasculitis. This inflammatory disorder affects women more often than men (as do most autoimmune diseases), almost exclusively after 50 years of age, and the average age is 72 years.⁵⁹ Histologically, GCA is characterized by a mononuclear cell infiltrate of T cells and macrophages that penetrates through the wall of arteries ([Fig. 20.11](#)). Approximately 50% to 60% of patients with GCA also have polymyalgia rheumatica.^{59,60} Because of the occlusive nature of the narrowing of vascular lumen, cranial pain, blindness, transient ischemic attacks, and other strokes are common complications in patients with GCA.⁵⁹

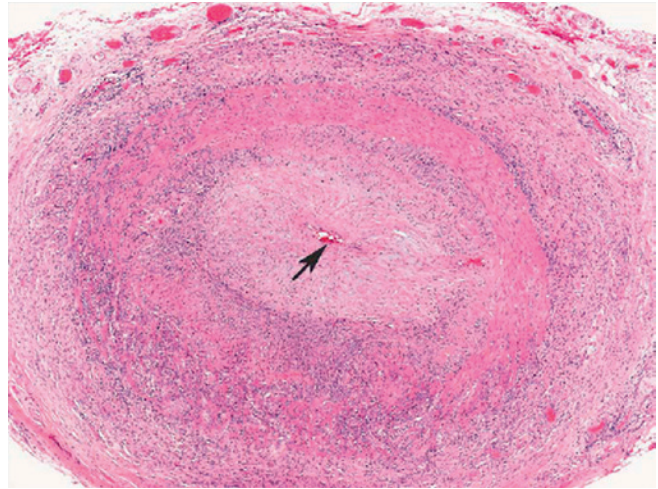

FIG 20.11 Histology of giant cell arteritis (GCA). A typical temporal artery affected by GCA shows characteristics such as panmural mononuclear inflammatory infiltrate, destruction of the internal and external elastic laminae, and concentric intimal hyperplasia. (From Albert DM, Robinson P, Nelson D, et al: *Albert & Jakobiec's principles & practice of ophthalmology*, ed 3, Edinburgh, 2008, Saunders.)

Symptoms and signs of GCA ([Box 20.7](#)) include excessive sweating, fever, malaise, anorexia, headaches and scalp tenderness, muscle aches (including muscles of mastication), and jaw pain. Obviously, these manifestations are very similar to those of temporomandibular disorders (TMDs) and orofacial pain conditions.⁵⁹

[Fig. 20.11](#) illustrates the histologic appearance of GCA. A typical temporal artery affected by GCA shows characteristics such as panmural mononuclear inflammatory infiltrate, destruction of the internal and external elastic laminae, and concentric intimal hyperplasia.⁵⁹

There are no specific laboratory tests for GCA. Typically, patients exhibit a high ESR and CRP, but these values are nonspecific. Angiography (particularly magnetic resonance angiography) can be helpful in making the diagnosis.⁵⁹

MEDICAL MANAGEMENT

The universal treatment for GCA is glucocorticoid therapy. Prednisone (60 mg/day) is the usual initial therapy. After the immune response has subsided and symptoms diminish, prednisone may be reduced by 10% per week. However, therapy may need to be resumed when symptoms return. Adjunctive therapy with aspirin also is quite helpful. The primary rationale for aspirin therapy is to reduce ischemic events in the obstructed vessels.⁵⁹

DENTAL MANAGEMENT

From a dental perspective, GCA is significant for several reasons. Major manifestations are temporal headaches and jaw claudication.^{59,60} Additionally, orofacial manifestations of GCA can lead to misdiagnosis of GCA as TMD.

BOX 20.7 Signs and Symptoms of Giant Cell Arteritis

Commonly Reported Signs and Symptoms

- Excessive sweating
- Fever
- General ill feeling
- Jaw pain (intermittent or when chewing)
- Loss of appetite
- Muscle aches
- Throbbing headache on one side of the head or the back of the head
- Scalp sensitivity; tenderness when touching the scalp
- Vision difficulties
- Blurred vision
- Double vision
- Reduced vision (blindness in one eye)
- Weakness, excessive tiredness
- Weight loss (>5% of total body weight)

Other, Less Common Signs and Symptoms

- Bleeding gums
- Face pain
- Hearing loss
- Joint stiffness
- Joint pain
- Mouth sores

*About 40% of people will have other, nonspecific symptoms such as respiratory complaints (most frequently dry cough) or weakness or pain along many areas. Rarely, paralysis of eye muscles may occur. A persistent fever may be the only symptom.

GCA should be included in the differential diagnosis for orofacial pain in older adults on the basis of knowledge of related signs and symptoms, including masticatory muscle pain, hard “end-feel” limitation of range of motion, and temporal headache.^{59,60} Early diagnosis and treatment are essential to avoid severe complications.

LYME DISEASE

DEFINITION

Lyme disease is a multisystem inflammatory disease caused by the tickborne spirochete *Borrelia burgdorferi*.⁶¹ The disease was first identified in the United States in 1975 during an outbreak around Lyme, Connecticut, of an inflammatory condition presumed to be JRA. The classical pattern of Lyme disease is a characteristic macular skin rash (erythema migrans) that appears within a month after the tick (*Ixodes dammini*) bite. Several different manifestations, including neurologic, articular, and cardiac, may follow.^{61,62}

Epidemiology

Lyme disease has been reported in North America, Europe, and Asia. In the United States, more than 90% of all cases of Lyme disease have been reported in only eight states (New York, Connecticut, Pennsylvania, Massachusetts,



FIG 20.12 Classic erythema migrans lesion of Lyme disease. (From Swartz M: *Textbook of physical diagnosis*, ed 6, St. Louis, 2010, Saunders.)

Rhode Island, New Jersey, Wisconsin, and Minnesota). Differences in the organism and in the immunogenetics of the affected population may explain the differences in clinical presentation of Lyme disease.^{2,61,62}

Pathophysiology and Complications

Precisely how *B. burgdorferi* causes Lyme disease is not clear. Vasculitis has been implicated in some cases of peripheral neuropathy, and a vascular lesion resembling endarteritis obliterans has been identified in the meninges and synovium of patients with Lyme disease.^{61,62}

The clinical manifestations of Lyme disease can be divided into three phases: early localized, early disseminated, and late disease. Patients with a diagnosis of Lyme disease may not be identified until later stages of the disease. Early localized disease includes erythema migrans and associated findings. Erythema migrans occurs in 50% to 80% of infected patients within 1 month of the tick bite.^{61,62} Only about 30% of patients can recall an associated tick bite. Erythema migrans presents as a “target” or “bull’s eye” lesion that typically appears in or near the axilla or belt line because ticks like warm, moist areas of the human body (Fig. 20.12).^{61,62} Most often, the lesion is asymptomatic, although it may itch, burn, or hurt. The lesion typically expands and enlarges over the course of a few days and can cause multiple lesions or a rash.^{61,62} Patients also may have an acute viremia-like syndrome with fever, malaise, nausea, myalgia, fatigue, headache, and arthralgias.^{61,62}

The next phase of clinical presentation is early disseminated disease, which may occur within a few days to a few months after the tick bite, possibly without preceding erythema migrans. The primary clinical manifestations of this phase are cardiac and neurologic problems.^{61,62} In the absence of treatment, about 8% of patients infected with Lyme disease manifest some cardiac problems, including heart block and myopericarditis.^{61,62} In most cases, the carditis begins to resolve, even without antibiotic therapy. Neurologic damage occurs in approximately

10% of untreated patients with Lyme disease. Primary manifestations include lymphocytic meningitis, cranial nerve palsy (especially of the facial nerve), and radiculoneuritis. In the late disease stage, which may occur months to years after the infection and may not be preceded by the earlier manifestations, musculoskeletal problems are the primary manifestation. Intermittent, migratory episodes of polyarthritis that mimic the “juvenile arthritis” originally described in cases of Lyme disease occur in approximately 50% of patients.^{61,62} Chronic arthritis of the knee is common, along with erosion of bone and cartilage. Chronic inflammatory joint disease may last for 5 to 8 years.^{61,62}

Late neurologic manifestations of Lyme disease, called *tertiary neuroborreliosis*, consist of encephalopathy, neurocognitive dysfunction, and peripheral neuropathy. Symptoms may be subtle and may be reported as headache and fatigue in addition to cognitive, mood, and sleep disturbances. Neuropsychological testing may be useful in confirming the diagnosis. FM is common in patients with Lyme disease.^{61,62}

Laboratory and Diagnostic Findings

Although the diagnosis of Lyme disease is based on clinical findings, serologic testing (antibodies against the pathogen) is important and necessary.^{61,62} Current practice is to confirm enzyme-linked immunosorbent assay results with Western blot analysis.⁵¹ Many other conditions (e.g., EBV infections, SLE, infective endocarditis) may mimic Lyme disease; therefore, laboratory testing should be performed for a definitive diagnosis. Antibody responses may be undetectable in infections of less than 6 weeks' duration, and early antibiotic therapy based on symptoms may render the infected patient seronegative. Most patients with late disease manifestations are strongly seropositive.^{61,62}

MEDICAL MANAGEMENT

Antibiotic therapy is effective for the treatment of patients with *B. burgdorferi* infection. Prompt antibiotic therapy when early symptoms are reported usually prevents progression to later stages of Lyme disease. Oral doses of 100 mg of doxycycline given twice daily for 3 to 4 weeks provide first-line treatment for early infection.^{61,62} Alternatively, tetracycline or amoxicillin (250–500 mg four times daily) may be given. In the late disseminated stages of Lyme disease and in pregnant women, IV antibiotics are often used. Some patients with arthritis are refractory to antibiotic therapy. These patients may benefit from intraarticular corticosteroid injections or hydroxychloroquine. Adequate therapy for neurologic damage is elusive, and recovery may be very slow.^{61,62}

DENTAL MANAGEMENT

The major dental consideration in Lyme disease is the identification of unusual symptoms in the absence of a

clear medical condition.^{61,62} Symptoms of fatigue, malaise, arthralgia, neuritis, or neuralgia, including facial palsy, may indicate the possibility of Lyme disease and the need for referral for proper medical diagnosis. Numerous reports have described facial nerve palsy that closely resembles Bell palsy caused by Lyme disease.^{61,62} The presentation of this facial palsy may be combined with other neurologic deficits or may stand alone. Involvement of the parotid glands (acute parotitis) has been reported. Along with facial nerve palsy, facial and dental neuralgia and TMJ symptoms have been reported to occur with Lyme disease.^{61,62}

FIBROMYALGIA

DEFINITION

Fibromyalgia is a common cause of chronic pain in the United States. The diagnosis of FM is typically difficult and lengthy because there are so many other potential causes for the widespread pain, including head and neck pain, back and extremity pain, and others. Chronic (several years) diffuse (muscle) pain accompanied by fatigue, sleep disturbance, and neuropathies (or other neurologic symptoms) are all cardinal symptoms of FM.^{2,63}

Epidemiology and Clinical Presentation

Fibromyalgia affects up to 4% of the population, primarily women. In 1990, the ACR adopted diagnostic classification criteria for FM, which are summarized in [Fig. 20.13](#).^{2,63} The dots indicate specific “tender points.” To meet the diagnostic criteria, the patient must have chronic (present for >3 months) widespread pain in all four quadrants of the body, and 11 of the 18 points must be painful on application of only 4 kg of pressure.^{2,63} Symptoms and signs of FM are listed in [Box 20.8](#).

MEDICAL MANAGEMENT

Successful management of FM requires a thorough analysis of the patient's biopsychosocial issues, including fatigue, sleep, pain, psychological distress, and so on. Management of central sensitization is beneficial using heterocyclic antidepressant agents such as amitriptyline, trazadone, or nortriptyline. Highly selective serotonin reuptake inhibitors such as fluoxetine exhibit a modest pain benefit in patients with FM. Anticonvulsant medications such as gabapentin, topiramate, or pregabalin are effective and are being used more frequently in the treatment of patients with FM. Opioids also are commonly used in patients with FM, but long-term trials are lacking, and they should not be the first choice of therapy.^{2,6,63}

DENTAL MANAGEMENT

The major discomfort with FM is muscle pain.^{63,64} Depending on which muscles are involved, patients may not be

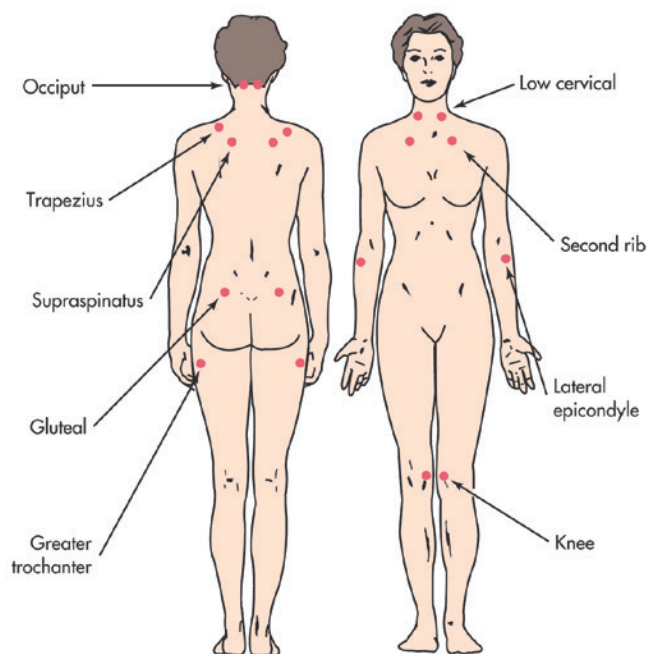

FIG 20.13 The American College of Rheumatology defines fibromyalgia as consistent tender points in 11 of these 18 anatomic locations. (Redrawn from Freundlich B, Leventhal L: The fibromyalgia syndrome. In Schumacher HR Jr, et al, editors: *Primer on the rheumatic diseases*, ed 11, Atlanta, 1997, Arthritis Foundation. Reprinted with permission from The Arthritis Foundation, 1330 W. Peachtree St., Atlanta, GA 30309.)

BOX 20.8 Symptoms of Fibromyalgia

- Body aches
- Chronic facial muscle pain or aching
- Fatigue
- Irritable bowel syndrome
- Memory difficulties and cognitive difficulties
- Multiple tender areas (muscle and joint pain) on the back of the neck, shoulders, sternum, lower back, hips, shins, elbows, knees
- Numbness and tingling
- Palpitations
- Reduced exercise tolerance
- Sleep disturbances
- Tension or migraine headaches

comfortable in a supine position in a dental chair. Therefore, just as with RA or OA, consideration should be given to providing a more upright chair position; using neck, back, and leg supports; and scheduling short appointments (see [Box 20.2](#)). Other dental management and treatment planning considerations are also similar to those for RA and OA.^{63,64}

The ACR has established specific diagnostic criteria for FM; however, there is a strong psychological component. Often patients with FM are treated with anxiolytic

drugs (benzodiazepines) or antidepressants (tricyclic agents). Patients may be focused on their chronic symptoms and develop central sensitization (see [Chapter 28](#)).^{63,64}

Oral Complications and Manifestations

Patients affected with FM may experience TMD-like features, resulting in severe pain upon wide opening, and pain occurring even with normal function, which worsens throughout the day. Adjacent muscle splinting and spasm may occur. Crepitus is a common finding in the affected joint.^{63,64}

The regional pain found with myofascial pain syndrome (MFP) needs to be distinguished from the widespread muscular pain associated with FM. In both cases, the pain is often described as a “chronic dull aching pain” and is central to the diagnosis of both disorders. It should be further noted that when the muscle pain is primarily due to the FM, it may not respond as well as the jaw pain from MFP because FM is a systemic and not a local condition, and muscle pain is a typical presentation in FM.^{63,64}

REFERENCES

1. Arthritis Foundation. <http://www.arthritis.org>.
2. American College of Rheumatology Clinical Practice Guidelines. <http://www.rheumatology.org/Practice-Quality/Clinical-Support/Clinical-Practice-Guidelines.2016>.
3. Arend WP, Lawry GV. Approach to the patient with rheumatoid disease. In: Goldman L, Schafer AI, eds. *Cecil Textbook of Medicine*. 25th ed. Elsevier; 2016:1648-1651. ISBN 978-1-4377-1604-7 [Chapter 264].
4. O'Dell JR. Rheumatoid arthritis. In: Goldman L, Schafer AI, eds. *Cecil Textbook of Medicine*. 25th ed. Elsevier; 2016:1681-1720. ISBN 978-1-4377-1604-7 [Chapter 272].
5. Azevedo PM, Bauer R, Caparbo Vde F, et al. Interleukin-1 receptor antagonist gene (IL1RN) polymorphism possibly associated to severity of rheumatic carditis in a Brazilian cohort. *Cytokine*. 2010;49:109-113.
6. Lipsky P, Diamond K. Autoimmunity and autoimmune disorders. In: Fauci A, Braunwald T, et al, eds. *Harrison's Principles of Internal Medicine*. 18th ed. Elsevier; 2015:2071-2083. ISBN 978-1-4377-1604-7 [Chapter 312].
7. Lipsky P. Rheumatoid arthritis. In: Fauci A, Braunwald T, et al, eds. *Harrison's Principles of Internal Medicine*. 18th ed. Elsevier; 2015:2014-2020. ISBN 978-1-4377-1604-7 [Chapter 314].
8. Royal College of Physicians. *Rheumatoid Arthritis: National Clinical Guideline for Management and Treatment in Adults*. London: Lavenham Press; 2009.
9. American College of Rheumatology Diagnostic classification of rheumatoid disorders. <http://www.rheumatology.org/Diagnosticclassification>. 2016.
10. Pistesky D. Laboratory testing in the rheumatic diseases. In: Ausiello DA, Goldman L, eds. *Cecil Textbook of*

- Medicine*. 25th ed. Elsevier; 2016:1651-1663. ISBN 978-1-4377-1604-7 [Chapter 265].
11. Singh JA. 2015 American College of Rheumatology Guidelines for the treatment of rheumatoid arthritis. *Arthr Care Res*. 2015;62(2):111-122.
 12. Arvidsson LZ, Flato B, Larheim TA. Radiographic TMJ abnormalities in patients with juvenile idiopathic arthritis followed for 27 years. *Oral Surg Oral Med Oral Pathol Oral Radiol Endod*. 2009;108:114-123.
 13. WebMD. Rheumatoid Arthritis Drug Guide. <http://www.webmd.com/rheumatoid-arthritis/guide/rheumatoid-arthritis-medications>.
 14. WebMD. Biologics for Rheumatoid Arthritis Treatment. <http://www.webmd.com/rheumatoid-arthritis/guide/biologics>.
 15. Singh JA, Cameron C, Noorbaloochi S, et al. Risk of serious infection in biological treatment of patients with rheumatoid arthritis. *Lancet*. 2015;386:258-264.
 16. Complications from biologic treatment of arthritis. WebMD. www.webmd.com/rheumatology/news. 2016.
 17. Little J. Patients with prosthetic joints: are they at risk when undergoing dental procedures? *Spec Care Dentist*. 1997;17:153-160.
 18. Lu N, Misra D, Neogi T, et al. Total joint arthroplasty and the risk of myocardial infarction a general population, propensity score-matched cohort study. *Arthr Rheumat*. 2015;67(10):2771-2779. doi:10.1002/art.39246.
 19. ADA/AAOS. Antibiotic prophylaxis for dental patients with prosthetic joints. *J Am Dental Assoc*. 2003;134:895-897.
 20. Little JW, Jacobson JJ, Lockhart PB, et al. The dental treatment of patients with joint replacements. *J Am Dental Assoc*. 2010;141:667-671.
 21. Watters W 3rd, Rethman MP, Hanson NB, et al; American Academy of Orthopaedic Surgeons; American Dental Association. Prevention of orthopaedic implant infection in patients undergoing dental procedures. *J Am Acad Orthop Surg*. 2013;21(3):180-189.
 22. Lockhart PB, Brennan MT, Sasser HC, et al. Bacteremia associated with toothbrushing and dental extraction. *Circulation*. 2008;117(24):3118-3125.
 23. Lockhart PB, Loven B, Brennan MT, et al. The evidence base for the efficacy of antibiotic prophylaxis in dental practice. *J Am Dent Assoc*. 2007;138:458-474.
 24. American Academy of Orthopaedic Surgeons; American Dental Association. Prevention of orthopaedic implant infection in patients undergoing dental procedures: evidence-based guideline and evidence report. Rosemont, IL: American Academy of Orthopaedic Surgeons; 2012. Available at: www.aaos.org/research/guidelines/PUDP/PUDP_guideline.pdf. Accessed 20 September 2014.
 25. Rethman MP, Watters W 3rd, Abt E, et al; American Academy of Orthopaedic Surgeons; American Dental Association. The American Academy of Orthopaedic Surgeons and the American Dental Association clinical practice guideline on the prevention of orthopaedic implant infection in patients undergoing dental procedures. *J Bone Joint Surg Am*. 2013;95(8):745-747.
 26. Sollecito T, Abt E, Lockhart P, et al. The use of prophylactic antibiotics prior to dental procedures in patients with prosthetic joints: evidence-based clinical practice guideline for dental practitioners—a report of the American Dental Association Council on Scientific Affairs. *J Am Dent Assoc*. 2015;146(1):11-17. <http://jada.ada.org>.
 27. Berbari EF, Osmon DR, Carr A, et al. Dental procedures as risk factors for prosthetic hip or knee infection: a hospital-based prospective case-control study. *Clin Infect Dis*. 2010;50:8-19.
 28. Griffin SO, Barker LK, Griffin PM, et al. Oral health needs among adults in the United States with chronic diseases. *J Am Dent Assoc*. 2009;140:1266-1274.
 29. Bracco P, Debernardi C, Piancino MG, et al. Evaluation of the stomatognathic system in patients with rheumatoid arthritis according to the research diagnostic criteria for temporomandibular disorders. *Cranio*. 2010;28:181-186.
 30. Pischon N, Pischon T, Kröger J, et al. Association among rheumatoid arthritis, oral hygiene, and periodontitis. *J Periodontol*. 2008;79:979-986.
 31. Pizzo G, Guiglia R, Lo Russo L, et al. Dentistry and internal medicine: from the focal infection theory to the periodontal medicine concept. *Eur J Intern Med*. 2010;21:496-502.
 32. Lane N, Schnitzer T. Osteoarthritis. In: Goldman L, Schafer AI, eds. *Cecil Textbook of Medicine*. 25th ed. Elsevier; 2016:1672-1681. ISBN 978-1-4377-1604-7 [Chapter 270].
 33. Osteoarthritis. Arthritis Foundation. 2016. www.arthritis.org/osteoarthritis.
 34. Felson D. Osteoarthritis. In: Fauci A, Braunwald T, et al, eds. *Harrison's Principles of Internal Medicine*. 18th ed. Elsevier; 2015:2014-2020. ISBN 978-1-4377: 2158-64 [Chapter 326].
 35. de Leeuw R, Boering G, Stegenga B, et al. Radiographic signs of TMJ osteoarthritis. *Oral Surg Oral Med Oral Pathol*. 1995;79:382-392.
 36. Powers DB. Systemic lupus erythematosus and discoid lupus erythematosus. *Oral Maxillofac Surg Clin North Am*. 2008;20:651-662.
 37. Lim D, Kim Y, Lee D, et al. Immunoglobulin G levels as a prognostic factor for autoimmune hepatitis in systemic lupus erythematosus. *Arthr Care Res*. 2016;68(7):995-1002.
 38. Crow NY. Systemic lupus erythematosus. In: Goldman L, Schafer AI, eds. *Cecil Textbook of Medicine*. 25th ed. Elsevier; 2016:1590-1612. ISBN 978-1-4377-1604-7 [Chapter 274].
 39. Mosca M, Tani C, Aringer M, et al. Development of quality indicators to evaluate the monitoring of SLE patients in routine clinical practice. *Autoimmun Rev*. 2011;69:1269-1274.
 40. Naguwa S, Gershwin ME. Sjogren's syndrome. In: Ausiello DA, Goldman L, eds. *Cecil Textbook of Medicine*. 25th ed. Elsevier; 2016:1651-1663. ISBN 978-1-4377: 1713-18 [Chapter 276].
 41. Albilal JB. Systemic lupus erythematosus: a review for dentists. *J Can Dent Assoc*. 2007;73:823-828.
 42. Rhodus NL, Johnson DK. The prevalence of oral manifestations of systemic lupus erythematosus. *Quintessence Int*. 1990;21:461-465.

43. Nazmul-Hossien A, Morarasu GM, Schmidt S, et al. A current perspective on Sjogren's syndrome. *J Calif Dent Assoc.* 2011;39(9):631-637.
44. Rhodus NL. Perspectives on Sjogren's syndrome. *J Missouri Dent Assn.* 2014;98(1):16-24.
45. Emamian ES, Leon JM, Lessard CJ, et al. Peripheral blood gene expression profiling in Sjogren's syndrome. *Genes Immun.* 2009;10:285-296.
46. Lessard CJ, Rasmussen A, Li H, et al. Identification of multiple genetic variants associated with Sjögren's syndrome involved in both the innate and adaptive immune responses. *Nat Genet.* 2013. doi:10.1038/ng.2792.
47. Shiboski SC, Shiboski CH, Criswell L, et al. New classification criteria for Sjögren's syndrome: a data-driven expert-clinician consensus approach within the SICCA Cohort. *Arthritis Care Res.* 2012;64:475-487.
48. Rasmussen A, Ice JA, Li H, et al. Comparison of the American-European Consensus Group Sjögren's syndrome classification criteria to newly proposed American College of Rheumatology criteria in a large, carefully characterized sicca cohort. *Ann Rheum Dis.* 2013;10:1-8. doi:10.1136/annrheumdis-2014.
49. Moutsopoulos HM. Sjogren's syndrome. In: Fauci AS, et al, eds. *Harrison's Principles of Internal Medicine.* 18th ed. New York: McGraw-Hill; 2015:2107-2111, [Chapter 317].
50. Rhodus NL, Colby SA, Moller K, et al. Dysphagia in patients with Sjogren's syndrome and systemic lupus erythematosus. *Oral Surg Oral Med Oral Path Oral Radiol.* 1995;79:305-310.
51. Rhodus NL. "Nutritional analysis of older adults with Sjogren's syndrome." *Gerodontology.* 1988;7(2):61-69.
52. Rhodus NL, Bloomquist C, Liljemark WA, et al. Oral *Candida albicans* in patients with Sjogren's syndrome. *Ear Nose Throat J.* 1999;78:47-53.
53. Rhodus NL, Michalowicz B. GCF levels, sulcular *Candida albicans* and periodontal status in patients with Sjogren's syndrome. *Quintessence Int (Berl).* 2005;36(3):228-233.
54. von Bültzingslöwen I, Sollecito T, Fox PC, et al. Salivary dysfunction associated with systemic diseases – systematic review and clinical management recommendations. *Oral Surg Oral Med Oral Path Oral Radiol Endod.* 2007;103(3s1):57-64.
55. Zero D, Brennan MT, Daniels T, et al. Clinical practice guidelines for oral management in Sjögren's disease: dental caries prevention. *J Am Dent Assoc.* 2015;8:15.
56. Ritchlin C. Psoriatic disease—from skin to bone. *Nat Clin Pract Rheumatol.* 2007;3:698-706.
57. Lim HM. Psoriatic arthritis. In: Ausiello DA, Goldman L, eds. *Cecil Textbook of Medicine.* 25th ed. Philadelphia: Saunders; 2016:2514-2520 [Chapter 446].
58. Mease P, Genovese MC, Gladstein G, et al. Abatacept in the treatment of patients with psoriatic arthritis: results of a six-month, multicenter, randomized, double-blind, placebo-controlled, phase II trial. *Arthritis Rheum.* 2011;63:939-948.
59. Weyland CM, Goronzy JJ. Giant cell arteritis. In: Klippel JH, et al, eds. *Primer on the Rheumatic Diseases.* New York: Springer; 2008:398-424.
60. Reiter S, Winocur E, Goldsmith C, et al. Giant cell arteritis misdiagnosed as temporomandibular disorder: a case report and review of the literature. *J Orofac Pain.* 2009;23:360-365.
61. Wormser GP. Lyme disease. In: Ausiello DA, Goldman L, eds. *Cecil Textbook of Medicine.* 25th ed. Elsevier; 2016:1651-1663. ISBN 978-1-4377-1930-36 [Chapter 329].
62. Rhodus NL, Falace DA. Oral concerns in Lyme disease. *Northwest Dent.* 2002;81:17-18.
63. Langford CA, Gilliland BC. Fibromyalgia and chronic fatigue syndrome. In: Fauci A, Braunwald T, et al, eds. *Harrison's Principles of Internal Medicine.* 18th ed. Elsevier; 2015:2014-2020. ISBN 978-1-4377: 2158-64 [Chapter 329].
64. Rhodus NL, Friction JF, Carlson P, et al. "Oral symptoms in patients with Fibromyalgia." *J Rheumatology.* 2003;30:1841-1844.

Organ Transplantation

DEFINITION

Organ transplantation is an integral component of modern medicine that has transformed the management of a wide variety of pediatric and adult medical conditions, in many cases providing long-term survival outcomes in what were otherwise fatal diseases. Organ transplantation can effectively restore vital organ function in patients with a variety of medical conditions, including inherited and genetic disorders (e.g., bone marrow failure syndromes, sickle cell disease, congenital cardiac disease), end-organ damage caused by chronic disease (e.g., diabetes-associated chronic renal disease, cardiomyopathy, Crohn disease), and cancer (e.g., leukemia, multiple myeloma, hepatocellular carcinoma). In some situations, organ transplantation is the only available option and is essential for survival; in other situations, it offers the potential for improved disease control and better quality of life. Kidney, heart, liver, pancreas, lung, small bowel, bone marrow, and composite tissues (composed of skin, muscle, tendon, nerves, bone, and blood vessels) may be considered for transplantation for the appropriate recipient.

Essential principles of organ transplantation involve (1) the immunology underlying proper donor and recipient matching and (2) the need for immunosuppressive therapy for prevention and management of graft rejection. Bone marrow, or hematopoietic cell transplantation (HCT), is unique in that there is no sophisticated surgical procedure but rather a cellular infusion of hematopoietic stem cells (which naturally home to the bone marrow where hematopoiesis is established), and rather than risk of long-term chronic graft rejection as with solid organ transplantation, the major immune-mediated complication is graft-versus-host disease (GVHD), in which the engrafted donor immune system attacks the recipient host tissues in an autoimmune-like manner. Solid organ transplantation is limited primarily by the availability of organ donors and limitations in organ procurement from cadavers. In some cases, organs are obtained from living donors, primarily with renal transplantation and HCT but also with newer approaches to partial pancreas and liver transplantation.

Organ transplant recipients require comprehensive dental screening and clearance before transplantation to reduce infection risk. After transplantation, these patients have unique oral health considerations that are largely

related to the administration of immunosuppressive medications and corresponding long-term immunosuppression. In the context of HCT, in addition to immunosuppression, GVHD can have a significant and quite direct impact on oral health and function. The dentist must understand the basic principles of risk assessment and dental treatment planning before organ transplantation, as well as be able to provide safe and appropriate long-term comprehensive oral health care management in the post-transplantation setting.

CRITICAL COMPLICATIONS: Organ transplant recipients are at high risk for developing oral infections as well as noninfectious long-term complications, including oral cancer. These events could prove fatal. Before transplantation, dentists must work closely with the medical team to develop a dental management plan that will be effective and safe for the patient. The dentist must understand how to assess risk based on history and clinical findings and be able to recognize oral complications and provide appropriate management or referral.

Epidemiology

The first attempts at organ transplantation in the 1950s and 1960s were followed by increased activity that unfortunately resulted in very poor survival outcomes. Major advances in organ transplantation have been facilitated by improved understanding of, and mechanisms for, donor–recipient matching, development of effective immunosuppressive agents, improved surgical techniques (including percutaneous biopsy of solid transplanted organs to monitor rejection), and the acceptance of the concept of “brain death” as a definition for determining death of potential donors.^{1,2} Transplantation of the kidney, liver, heart, lungs, intestines, pancreas, and bone marrow may be considered as a treatment option, in many cases lifesaving, for selected patients with end-organ disease (Tables 21.1 and 21.2).

Kidney Transplantation. A team led by Dr. Joseph E. Murray, a Nobel laureate, performed the first successful human organ transplant procedure in Boston in 1954 using a kidney donated by the patient’s identical twin brother.³ Today more than 10,000 renal transplantations are performed annually in the United States and more than 75,000 worldwide.^{3,4} The most common indications for kidney transplantation is end-stage renal disease secondary to glomerulonephritis, pyelonephritis, diabetic

TABLE 21.1 Adult Survival Rates After Organ Transplantation*

Organ	Organs Transplanted in U.S.—Adults (2015)* (n)	1-Year Patient Survival Rate (Deceased Donor) [†] (%)	3-Year Patient Survival Rate (Deceased Donor) [†] (%)	1-Year Patient Survival Rate (Living Donor Recipients) [†] (%)	3-Year Patient Survival Rate (Living Donor Recipients) [†] (%)
Kidney	17,161	96.7	91.4	98.8	95.8
Pancreas (all)	186				
Pancreas alone		97.6	94.9		
Pancreas after kidney		94.1	95.9		
Pancreas–kidney (SPK)	719	97.4	95.1		
Liver	6547	91.3	82.7	90.3	86.4
Heart	2347	90.4	84.3		
Lung	2016	87.2	69.3		
Heart–lung	12	83.3	54.2		
Intestine	83	76.3	65.3		

*Data from Organ Procurement and Transplantation Network. Data <https://optn.transplant.hrsa.gov/data>.

[†]Data from SRTR transplant program reports, June 2016 <https://www.srtr.org/>.

TABLE 21.2 Pediatric Survival Rates After Organ Transplantation*

Organ	Organs Transplanted in U.S.—Pediatric (2015)* (n)	1-Year Patient Survival Rate (Deceased Donor) [†] (%)	3-Year Patient Survival Rate (Deceased Donor) [†] (%)	1-Year Patient Survival Rate (Living Donor Recipients) [†] (%)	3-Year Patient Survival Rate (Living Donor Recipients) [†] (%)
Kidney	718	99.7	99.0	98.8	99.1
Pancreas (all) [‡]	42				
Pancreas alone					
Pancreas after kidney					
Pancreas–kidney (SPK)	0				
Liver	580	95.5	93.0	97.6	95.7
Heart	456	92.4	88.1		
Lung	41	86.7	72.2		
Heart–lung	3				
Intestine	58	86.5	77.5		

*Data from Organ Procurement and Transplantation Network. Data <https://optn.transplant.hrsa.gov/data>.

[†]Data from SRTR transplant program reports, June 2016. <https://www.srtr.org/>.

[‡]No pediatric survival is calculated for this organ.

nephropathy, and congenital kidney disorders. The 1-year survival rate among renal transplant recipients is greater than 97%, and the 5-year survival rate is more than 90%, providing longer survival and better quality of life than dialysis.^{3,4}

Heart Transplantation. The first human heart transplantation was performed in 1967 in Cape Town, South Africa. The primary indications for heart transplantation include severe cardiomyopathy, severe coronary artery disease, and congenital heart disease.^{5,6} Nearly 2500 heart transplant procedures are performed annually in the United States, with a 1-year survival rate of greater than 90% and a 5-year survival rate of 75%.^{5,7}

Liver Transplantation. Since liver transplantation was first successfully performed in 1967, this procedure has offered the only option for long-term survival in patients with acute liver failure and end-stage liver disease.⁸ More

than 6000 liver transplant procedures are performed annually worldwide, with clinical indications including extrahepatic biliary atresia, primary biliary cirrhosis, chronic hepatitis (HCV infection), advanced cirrhosis, sclerosing cholangitis, nonalcoholic steatohepatitis, alcoholic liver disease, fulminant hepatic failure, and hepatobiliary cancers.^{9–11} Survival rates at 1 and 5 years are over 85% and 70%, respectively.¹⁰

Pancreas and Islet Cell Transplantation. The first pancreas transplant procedure, which also included a duodenum and a kidney, was performed in 1966 by a team led by Kelly and Lillehei at the University of Minnesota in a patient with diabetic nephropathy.¹² The objective of pancreas transplantation is to restore normal blood glucose levels, effectively curing diabetes and limiting the progression of diabetes-related complications.¹³ Pancreas transplantation can be performed in several ways:

pancreas transplant alone, simultaneous pancreas and kidney transplant (either both from deceased donor, or pancreas from deceased donor and kidney from live donor), and pancreas after kidney transplant. The primary indication for pancreas transplantation is in persons with diabetes mellitus (overwhelmingly type 1) who have or are at high risk of secondary complications (e.g., nephropathy), have life-threatening hypoglycemic awareness, or are likely to develop either of these conditions and are sufficiently fit to survive the procedure.¹⁴ Pancreas transplantation is performed far less frequently for pancreatitis or cancer. The number of pancreas transplants performed annually has been decreasing, now at approximately 1000 per year in the United States, possible because of improved insulin delivery systems as well as increasing use of islet cell transplantation.¹⁵ When taking into account all types of pancreas transplantation, the survival rates are greater than 96% at 1 year and more than 80% at 5 years.^{15,16}

Pancreatic islet cell transplantation is an effective alternative to whole-pancreas transplantation in which islet cells are isolated from the donor pancreas (after being surgically removed) and infused into the recipient.¹⁷ The primary indication for islet cell transplantation is brittle diabetics with hypoglycemic unawareness (patients who are unaware of deep drops in blood glucose levels) that is not compatible with daily life and without advanced cardiac disease or nephropathy.^{17,18}

Lung Transplantation. Lung transplantation was first performed in 1963 and today is the standard of care therapy for select patients with advanced and disabling pulmonary diseases that are not amenable to other medical or surgical therapies.¹⁹⁻²¹ Lung transplantation remains a fairly high risk procedure with a median recipient survival time of just more than 5 years.²² Indications for lung transplantation include chronic obstructive pulmonary disease, α_1 -antitrypsin deficiency, idiopathic pulmonary fibrosis, cystic fibrosis, and idiopathic pulmonary arterial hypertension (IPAH).^{22,23} Patients may be considered for single lung or bilateral lung transplantation and less frequently ($\approx 3\%$ of all lung transplants) combined heart-lung transplantation in patients with Eisenmenger syndrome with surgically uncorrectable cardiac defects as well as select patients with IPAH.¹⁹

Intestinal Transplantation. Intestinal transplantation is a lifesaving procedure indicated for management of intestinal failure (IF) secondary to a range of pathologic conditions.²⁴ In 2000, the U.S. Centers for Medicare & Medicaid Services approved isolated small bowel intestinal, combined liver-intestinal, and multivisceral transplantation as standard of care for patients with irreversible intestinal and parenteral nutrition failure.²⁵ With advances in medical management of IF, the number of intestinal transplants performed annually in the United States has steadily decreased from 198 in 2007 to 106 in 2012.²⁵ Given the abundance of lymphoid tissue within the graft, recipients are at high risk for acute and chronic rejection but also to a lesser extent GVHD, although this tends to be a

much more limited condition compared with GVHD post-HCT.

Survival outcomes are lowest in adult intestine-liver recipients, with 1- and 5-year survival rates of 69.1% and 46.1%, respectively, and highest in pediatric intestine recipients, with 1- and 5-year survival rates of 89.2% and 81.4%, respectively.²⁴ Risk of early graft loss is considerable, with the primary causes being sepsis, rejection, and cardiovascular events.

Hematopoietic Cell Transplantation. Since Thomas et al first reported successful bone marrow transplantation between identical twins in 1956, it has become a standard therapy for certain hematologic deficiencies and malignancies.²⁶⁻²⁸ Because the hematopoietic progenitor stem cells actually serve as the “graft” that homes to and repopulates the recipient marrow, and with the majority of donor grafts obtained from peripheral blood stem cells rather than from harvested bone marrow, this procedure is more commonly referred to as *hematopoietic cell transplantation*. With malignant disease, much of the benefit of HCT is in the potent graft-versus-tumor effect, in which engrafted donor cells mount an alloimmune response against residual malignant cells, effectively providing long-term immunotherapy.²⁹ Autologous HCT, in which a patient’s stem cells are collected, isolated, and preserved before receiving high-dose myeloablative chemotherapy and then reinfused as a “stem cell rescue” procedure, is not truly “transplantation” because there is no allograft, and it is only discussed briefly in this chapter.

Even when donor-recipient human leukocyte antigen (HLA) matching is optimized and despite administration of GVHD prophylaxis regimens with immunosuppressive medications, GVHD is a major complication of allogeneic HCT and the leading cause of nonrelapse mortality.³⁰ The most common indications for HCT include acute and chronic leukemia, myelodysplastic syndrome, lymphoma, aplastic anemia, severe immunodeficiency syndromes, and hemoglobinopathies.²⁷ The Center for International Blood and Marrow Transplantation (CIBMTR) reports nearly 8000 allogeneic HCT procedures performed annually in the United States.³¹ Survival outcomes vary widely based on a number of factors, including underlying diagnosis and status at time of transplantation, donor type, and graft characteristics.³²

Vascularized Composite Tissue Allograft Transplantation. Composite tissues that may be transplanted include skin, mucosa, muscle, and bone, among other structures, and may be used to replace lost or dysfunctional anatomic structures.³³ Composite tissue allograft transplantation, although never lifesaving, has the potential to greatly improve the recipient’s quality of life. Because the procedure requires long-term immunosuppression, this carries risks of opportunistic infection, organ failure, and cancer. The first successful hand transplantation was reported by Dubenard et al in 1998 and the first partial face transplantation in 2005.^{34,35} In addition, there have been less frequent

reports of transplantation of other tissues, including the abdominal wall, larynx, and penis.³³ This is a rapidly developing yet still largely experimental procedure within the field with highly variable graft survival outcomes.³³

Etiology

The remarkable successes in transplant medicine have been largely related to advances in the understanding of key clinical immunologic principles of donor–recipient matching, establishment and coordination of organ donor networks, incorporation of standardized immunosuppression regimens, and improvements in supportive care. HLA matching of donor and recipient reduces the risk of graft rejection (and in the case of HCT, also GVHD), a major complication of organ transplantation characterized by a host immune response to tissues expressing nonself histocompatibility antigens.³⁶

Donor–Recipient Matching. Donors and recipients are matched using two different laboratory tests.^{36,37} First, HLA antigen expression is determined on donor and recipient leukocytes through serologic or more frequently DNA-typing assays. The second test is serologic cross-matching, which functionally measures recipient immune cell response to exposure to donor cell antigens, and, in the case of HCT, donor immune cell response to recipient cell antigens. Serologic cross-matching is particularly important in the primarily vascularized grafts of the kidney and heart. This test exposes donor cells to recipient serum and evaluates for the detection of antibodies to red blood cell or HLA antigens, both of which correlate with acute graft rejection.³⁸ The National Marrow Donor Program (NMDP), which coordinates unrelated donor matching for HCT, requires high-resolution DNA-based matching of HLA-A, HLA-B, HLA-C, and DRB1, optimally with a four of four match, or if not possible, then a single mismatch at one of the four loci.³⁹ The Organ Procurement and Transplant Network (OPTN) requires HLA-A, HLA-B, and DR antigen typing of the donor and recipient.³⁷

Organ Donation Networks. The United Network for Organ Sharing (UNOS; <https://www.unos.org>) is a non-profit organization that operates the OPTN under a long-term contract from the U.S. Department of Health and Human Services.⁴⁰ The Organ Center of the OPTN/UNOS supports the U.S. transplant community 24 hours a day, 365 days a year, through providing resource support about organ-sharing policies and processes, managing the computerized donor–recipient match results, coordinating donation of deceased donor organs, and arranging transportation for shared organs.⁴⁰ Approximately 70% of patients requiring HCT do not have a matched related donor, necessitating coordination of matched unrelated graft donations through a robust and highly organized network of volunteer donors. The NMDP coordinates all aspects of donation and matching throughout all US HCT centers.³⁹ The CIBMTR (<https://www.cibmtr.org>) is a research collaboration between the NMDP and the Medical College of Wisconsin that facilitates critical

observational and interventional research through a large network of transplant centers, a clinical outcomes database, and scientific and statistical expertise.⁴¹ The vast majority of organ donations within the United States are coordinated through the NMDP (for HCT) and OPTN (for solid organs).

Immunosuppressive Medications. Despite optimal HLA matching, even in matched related donor kidney and hematopoietic cell transplants, nonspecific immunosuppressive agents are necessary to prevent acute and chronic graft rejection.^{1,30,36} Although effective at preventing and managing rejection, long-term administration of immunosuppressive therapies increases the recipient's susceptibility to infection and malignancy. The main immunosuppressive medications used in transplant medicine include corticosteroids (prednisone; methylprednisolone for intravenous therapy), antimetabolites (azathioprine and now typically mycophenolate mofetil), calcineurin inhibitors (CNIs; cyclosporine and tacrolimus), and mTOR (mammalian target of rapamycin) inhibitors (sirolimus, everolimus; [Table 21.3](#)). Immunosuppressive medications may be used in the following clinical situations: induction therapy (profound immunosuppression at the time of transplant surgery), GVHD prophylaxis, management of acute rejection and acute GVHD episodes, and maintenance immunosuppression for management of chronic rejection and chronic GVHD.^{30,36} Other immunosuppressive therapies used include antithymocyte globulin (ATG); monoclonal antibody therapies such as alemtuzumab, rituximab, and basiliximab; and extracorporeal photopheresis. With solid organ transplantation, induction typically consists of prednisone and a CNI (with or without mycophenolate and other agents), with varying tapering regimens based on a variety of factors. Acute rejection episodes are managed with high-dose corticosteroids and antilymphocyte (e.g., ATG) therapies.

With HCT, in addition to the conditioning regimen (which prevents rejection and allows for engraftment), a GVHD prophylaxis regimen is administered that typically consists of a short course of methotrexate and long-term CNI therapy that is gradually tapered over 3 to 6 months in the absence of GVHD.^{30,36} Chronic rejection and chronic GVHD are managed similarly with various combinations of immunosuppressive agents.

Pathophysiology and Complications

Complications associated with organ transplantation generally consist of graft rejection, problems related to chronic immunosuppressive therapy, and special problems specific to the transplanted organ.

Graft Rejection. Graft rejection is a potentially very serious complication of organ transplantation that can occur despite donor–recipient matching and the administration of immunosuppressive medications. *Hyperacute rejection* of solid organs occurs within 48 hours of surgical anastomosis and is mediated by preformed antibodies and complement activation, and it requires immediate

TABLE 21.3 Immunosuppressive Medications Commonly Used in Transplant Medicine

Agent	Class	Mechanism of Action	Important Side Effects or Monitoring	Important Drug Interactions	Oral Complications
Prednisone	Corticosteroid	Blocks cytokine gene transcription	Cushing syndrome, diabetes, hypertension, myopathy, avascular necrosis, osteoporosis, glaucoma, cataracts	Potentiates effects of concomitant therapy with other immunosuppressive medications	Increases risk of oral candidiasis, recrudescence HSV infection, poor healing
Cyclosporine	Calcineurin inhibitor	Broadly acting immunosuppressant			
		Inhibits IL-2 gene transcription	Hypertension, nephrotoxicity, tremors	Fluconazole may increase cyclosporine levels	Gingival overgrowth
Tacrolimus	Calcineurin inhibitor	Reduces activation of T cells	BUN/Cr, LFTs, potassium, magnesium, lipid panel, serum drug levels		
		Inhibits IL-2 gene transcription	Hypertension, nephrotoxicity, tremors	Fluconazole may increase tacrolimus levels	Pyogenic granuloma-like lesions
Azathioprine	Nucleoside inhibitor	Reduces activation of T cells	Cr, potassium, fasting blood glucose, serum drug levels		
		Impairs DNA synthesis	Leukopenia, myelosuppression, hepatotoxicity		
Mycophenolate mofetil	Nucleoside inhibitor	Inhibits T and B cell proliferation	Cr, CBC, LFTs		
		Impairs DNA synthesis	Hypertension, anemia, leukopenia, diarrhea		
Sirolimus	mTOR inhibitor	Inhibits T- and B-cell proliferation	CBC, Cr		
		Inhibits mTOR complex	Hyperlipidemia, diabetes	Fluconazole may increase sirolimus levels	Aphthous-like ulcers
Everolimus	mTOR inhibitor	Reduces T cell proliferation	Lipid panel, serum drug levels		
		Inhibits mTOR complex	Hyperlipidemia, diabetes	Fluconazole may increase everolimus levels	Aphthous-like ulcers
		Reduces T cell proliferation	Lipid panel, fasting blood glucose, serum drug levels		

BUN, Blood urea nitrogen; CBC, complete blood count; Cr, creatinine, HSV, herpes simplex virus; IL-2, interleukin-2; LFT, liver function test; mTOR, mammalian target of rapamycin.

graft removal; this complication is generally avoidable through cross-matching.^{36,42} *Acute rejection*, mediated by T cells and antibodies, occurs within the first 90 days after transplantation and generally responds to high-dose steroids and antilymphocyte therapies.³⁶ *Chronic rejection* of solid organs is primarily antibody mediated and, despite treatment with immunosuppressive medications, is generally irreversible.³⁶

Immunosuppression and Infection Risk. Immunosuppressive medications nonspecifically block T- and B-cell activity as well as innate immunity effector cells and pathways, significantly increasing the risk for infection. Screening of donor and recipient for major infections

before transplant is essential to reduce the risk of infectious complications.⁴³ In addition, transplant recipients receive extensive education and guidance on other preventive strategies, including hygiene, environmental exposures, and food safety handling.⁴³ Signs and symptoms of infection may be subtle or even nonexistent because of the effects of immunosuppressive therapies, and, in some cases, a more aggressive workup may be necessary to confirm or rule out a diagnosis.^{44,45} Although most HCT recipients eventually have all immunosuppressive therapy discontinued, those who develop GVHD may require years of immunosuppressive therapy, and solid organ transplant recipients generally require lifelong immunosuppression.⁴⁶

Patients with chronic rejection or chronic GVHD require more intense immunosuppression and are therefore at even higher risk for infection.⁴⁶

In the early posttransplant period, patients are primarily at risk for nosocomial infections (e.g., methicillin-resistant *Staphylococcus aureus* [MRSA]), opportunistic infections (e.g., oropharyngeal candidiasis, aspergillus), and donor-derived infections. *Viridans streptococci* are bacterial microorganisms frequently isolated from blood cultures of patients undergoing HCT, and poor dental health has been associated with an increased risk of streptococcal bacteremia in this setting.^{47,48} From 1 to 6 months posttransplantation, when patients tend to be most highly immunosuppressed, there is high risk of both opportunistic infections (e.g., BK virus, adenovirus) and reactivation of latent infections (e.g., cytomegalovirus [CMV]).⁴⁹ Invasive fungal infections tend to occur within the first 3 months of transplantation. Infections occurring more than 6 months after transplantation tend to be typical community-acquired infections (e.g., pneumonia; urinary tract infections, especially in kidney transplant recipients) but may have more severe manifestations than in the general population.^{44,50} HCT recipients are at highest risk for infection because the entire immune system in effect is reconstituted over a period of months to years.⁵¹

Other Side Effects of Immunosuppressive Medications. In addition to increasing the risk of infection, immunosuppressive medications are associated with various short- and long-term side effects that can have significant medical implications for these patients (Table 21.3). CNI therapy (cyclosporine and tacrolimus) is associated with development of chronic kidney disease and renal insufficiency that can progress to end-stage renal disease; therefore, routine renal function monitoring is indicated, and medication levels in the blood are carefully monitored.⁵² Other potential complications of CNI therapy include tremors, magnesium wasting, hypertension, hyperkalemia, hyperuricemia, and hyperglycemia.⁴⁴ Mycophenolate is associated with myelosuppression and gastrointestinal (GI) side effects (diarrhea and inflammatory bowel disease–like condition). Azathioprine has a similar mechanism of action as mycophenolate but is used less frequently because of less favorable side effect profile. Side effects of prednisone therapy increase with dose and duration and include hyperglycemia (which can progress to diabetes requiring insulin), hypertension, hyperlipidemia, osteoporosis and avascular necrosis. The mTOR inhibitors (sirolimus and everolimus) are associated with cytopenia and hyperlipidemia, requiring routine laboratory and blood level monitoring.⁴⁴

Cancer Risk. Organ transplant patients are at increased risk for posttransplant lymphoproliferative disease (PTLD) and nonmelanoma skin cancers related to the intensity and duration of immunosuppressive therapy and sun exposure, including dysplastic and malignant lip lesions.^{44,53,54} In addition to nonmelanoma skin cancers, HCT patients are at significantly increased risk for

melanoma, liver, oral cavity, brain, thyroid, and bone cancers.^{55,56} PTLD is a lymphoma-like condition, often but not always EBV positive and of B-cell origin, that typically develops in the early posttransplant period when patients are highly immunosuppressed. The incidence of PTLD ranges from approximately 1% in renal transplant recipients and matched related and unrelated HCT, to 4.5% in liver transplantation.⁵⁷⁻⁵⁹ Management of PTLD includes reduction of immunosuppression (if feasible) and chemotherapy (e.g., anti-CD20 monoclonal antibody therapy), with an overall 5-year survival rate of 40% to 60%.⁵⁷

Organ-Specific Complications

Kidney Transplantation. Although BK virus infection can affect any transplant patient, renal transplant recipients are at particular risk for BK virus nephropathy.⁴⁹ This can be distinguished from rejection by biopsy and is managed primarily with reduction of immunosuppression. Renal graft rejection is monitored primarily by serum creatinine measurement rather than biopsy, and if graft failure occurs, hemodialysis can be initiated.

Heart Transplantation. Cardiovascular disease affecting the transplanted heart can arise from the donor heart because of preexisting pathology; de novo related to traditional or existing risk factors; or from allograft vasculopathy, a form of coronary artery disease and a major source of morbidity.⁵ Because of denervation as part of the surgical transplant procedure, heart transplant recipients do not typically experience symptoms of angina and therefore require intensive monitoring for allograft vasculopathy by annual angiography. All heart transplant recipients receive lifelong statin therapy regardless of lipid levels. In addition to surveillance by endomyocardial biopsy, rejection may present with typical symptoms of heart failure.

Liver Transplantation. In addition to graft rejection, recurrent underlying disease for which transplant was indicated is a potentially serious complication in liver transplantation and can lead to transplant failure.^{8,44} Both HCV infection and alcohol abuse have high likelihoods of recurrence and require routine screening and active treatment if detected.

Lung Transplantation. Rejection in lung transplant recipients may present with dyspnea, cough, and hypoxia.¹⁹ Lung function is monitored by spirometry with transbronchial lung biopsy performed as needed to rule out or confirm acute rejection. Bronchiolitis obliterans, the characteristic feature of chronic rejection, is less readily determined by transbronchial biopsy and is therefore diagnosed and monitored based primarily on spirometric measures and changes over time.

Hematopoietic Cell Transplantation. Although graft rejection is relatively rare in HCT because of the effective immunosuppression of the conditioning regimen, GVHD is a very serious and potentially life-threatening complication in which engrafted donor lymphocytes mount a

multifaceted alloimmune-mediated attack against the recipient–host tissue, resulting in a wide range of autoimmune disease–like features.³⁰ Acute GVHD typically occurs within the first 100 days after HCT and is characterized by skin rash, elevated liver transaminases, and diarrhea. Chronic GVHD typically occurs after day +100, affecting most frequently the skin, mouth, eyes, liver, and lungs, contributing to significant disability, reduced quality of life, and mortality.^{60–62} Of note, end-organ pathology of chronic graft rejection in solid organ transplantation and chronic GVHD can be very similar, for example, with bronchiolitis obliterans with lung transplantation and GVHD.

Solid organ transplantation can very rarely be associated with GVHD. The risk is greatest with intestinal transplantation, but GVHD has been reported after transplantation of other solid organs.⁶³ With facial transplantation, graft rejection of transplanted skin and oral mucosa presents clinically and histopathologically identical to GVHD.⁶⁴

CLINICAL PRESENTATION

Signs and Symptoms

In the absence of treatment-related comorbidities (e.g. chronic rejection, GVHD, infections), transplant recipients with good organ function generally have normal function and performance status, similar to the general population. With chronic rejection of solid organs, depending on the degree and extent of organ function compromise, the clinical presentation may resemble that of the pretransplant disease status. Signs and symptoms of GVHD vary widely, with skin rash and diarrhea most common in the acute setting and skin rash and fibrosis, oral lichenoid inflammation and sensitivity, and eye dryness and discomfort most common in the chronic setting.³⁰

Laboratory and Diagnostic Findings

Laboratory testing in the transplant patient is critical for monitoring organ function, metabolism of medications, and infectious diseases. Protocols depend on the transplanted organ and institutional preferences. Blood pressure is monitored at every visit. A lipid panel and diabetes screening test should be ordered every 6 to 12 months, especially in patients on long-term CNI and corticosteroid therapies.⁴⁴ Monitoring of serum creatinine is important in renal transplant recipients to screen for rejection, as well as in all patients on CNIs and other immunosuppressive agents because of potential renal toxicity. Similarly, liver function testing is routinely performed in liver transplant recipients because rejection causes elevated transaminases, bilirubin, and alkaline phosphatase. The liver is also a frequent target of GVHD.⁶¹ Pulmonary function is monitored by spirometry (referred to generally as pulmonary function tests) and indicated in lung transplant patients as well as HCT patients with GVHD

or shortness of breath. Pancreas transplant rejection may manifest with compromised endocrine function or an increase in amylase levels.

Surveillance needle biopsy is routinely performed for most solid organs to screen for rejection. In some cases, biopsies may be obtained weekly or monthly early after transplantation and then less frequently (e.g., annually) thereafter; however, protocols vary among centers. GVHD can generally be determined from clinical features alone, but involved tissue histopathology (e.g., skin, oral mucosa, GI) may be helpful in supporting or ruling out the diagnosis.^{65,66} Cyclosporine, tacrolimus, and sirolimus are monitored by routine measurement of serum trough levels, with doses adjusted accordingly if needed.²⁷ CMV reactivation is monitored at predefined intervals by quantitative polymerase chain reaction, with a positive assay triggering initiation of preemptive therapy with ganciclovir, a reduction in the intensity of immunosuppression (if feasible), and intensified monitoring.⁴⁵ Transplant patients with a history of invasive fungal infection may be monitored for evidence of recurrent infection by serum glucan and galactomannan antigen testing.⁶⁷

MEDICAL AND SURGICAL MANAGEMENT

Medical management of organ transplant patients is largely based on principles of immunosuppression for prevention and management of graft rejection (or GVHD with HCT), infections, and screening for and management of late complications. Surgical management of graft failure and other organ-specific complications is beyond the scope of this chapter.

Immunosuppressive therapy is initiated at the time of transplantation (“induction” in solid organ transplantation, “conditioning and GVHD prophylaxis” in HCT), and although regimens are generally similar, there is some degree of variability based on the transplanted organ, patient-specific factors, and institutional preferences. In solid organ transplantation, this typically consists of triple-drug therapy with a corticosteroid (prednisone, which is typically tapered over a period of weeks), a calcineurin inhibitor (cyclosporine or more commonly tacrolimus), and a purine synthesis inhibitor (traditionally azathioprine but now almost exclusively mycophenolate). Antilymphocyte therapy (e.g., ATG) may be included as part of the initial immunosuppressive therapy or used in the management of rejection episodes. Sirolimus is variably used in some protocols, in particular to reduce the need for CNI therapy, for example, in renal transplantation to minimize CNI-associated nephrotoxicity. In HCT, GVHD prophylaxis regimens typically consist of a short course of methotrexate (for several days after graft infusion) combined with a CNI that in the absence of GVHD is tapered over a 3- to 6-month period.^{27,28}

First-line therapy for rejection and GVHD is corticosteroids, with second-line therapies including, in addition to the immunosuppressive medications already discussed,

rituximab, alemtuzumab, extracorporeal photopheresis, and low-dose IL-2.⁶⁸⁻⁷⁰ Management of relapse of underlying hematologic malignancy after HCT includes rapid tapering of immunosuppressive therapy and donor lymphocyte infusion, both of which are intended to stimulate a potent graft-versus-tumor effect but also typically trigger development of GVHD.³⁰

Organ transplant patients on immunosuppressive therapy are at high risk for a wide spectrum of infections. Infections can progress rapidly, making early diagnosis and initiation of effective therapy critical. The diagnosis can be challenging because of diminished signs and symptoms of infection, in some cases justifying invasive diagnostic procedures (e.g., bronchoscopy) to ensure appropriate and effective management.⁴⁵ Infectious disease prophylaxis strategies are based on known or likely exposures to infectious agents based on serologic testing and epidemiologic history, as well as intensity and duration of immunosuppression.⁴⁵ Both the American Society of Transplantation and the American Society for Blood and Marrow Transplantation (along with additional professional organizations including the CIBMTR, the European Blood and Marrow Transplant Group, and the Infectious Disease Society of America) have published and regularly updated infectious diseases guidelines.^{41,71,72} Preventive strategies include vaccination (no live vaccines), universal antimicrobial prophylaxis, and preemptive therapy.^{45,73} The risk of donor-derived infections is largely reduced through effective pretransplant screening.⁴³ With respect to recipient-derived infections, any active infection should be eradicated before transplantation, and patients must be carefully monitored for evidence of reactivation.

Of particular relevance from an oral health standpoint are guidelines related to herpes simplex virus (HSV) infection and oropharyngeal candidiasis. Acyclovir prophylaxis is started at the initiation of immunosuppressive therapy for HSV-seropositive patients and continued for at least 30 days, with variable duration based on the type of transplant, intensity and duration of immunosuppressive therapy, and institutional protocols.^{41,74} The Infectious Disease Society of America Clinical Practice Guidelines for the Management of Candidiasis recommends daily antifungal prophylaxis with fluconazole or liposomal amphotericin B for solid organ transplant recipients at high risk of candidiasis and fluconazole, posaconazole, or micafungin in HCT patients during periods of neutropenia.^{75,76}

Recommended guidelines are available for long-term preventive and screening practices for organ transplant recipients.⁷⁷⁻⁷⁹ Although some recommendations are organ and disease specific, as well as age specific in pediatric transplantation, most are related to administration of immunosuppressive medications and are therefore generally universal to all organ transplant patients. These include guidelines related to immunity and infections (e.g., vaccination schedules), ocular health (largely related to GVHD), oral health (largely related to GVHD), pulmonary health, cardiovascular health, hepatic health, renal health,

genitourinary health, musculoskeletal health, nervous system and mental health, endocrine health (of particular importance in pediatrics), psychosocial health, and secondary cancer screening.

DENTAL MANAGEMENT

General Principles and Basic Oral Care

Organ transplant patients have unique dental management needs throughout the course of their medical care compared with the general population. Because of the anticipated period of profound immunosuppression after transplantation, it is standard of care for all organ transplant candidates to undergo pretransplant dental screening and clearance to reduce the risk of infectious complications. In case of rejection, or GVHD, long-term immunosuppressive therapy may be indicated, extending the period of infection risk and further emphasizing the importance of oral health care maintenance. Throughout the course of medical care, all transplant patients should perform basic oral care to maintain good oral health and reduce the risk for local inflammation and infection, as well as potential systemic infection that may arise from the oral cavity.⁸⁰ Basic oral care consists at minimum of tooth brushing with a soft tooth brush and fluoride toothpaste at least twice a day and flossing daily.⁸⁰ Patients with a history of gingivitis or periodontitis may also benefit from daily chlorhexidine gluconate rinses, and this is often included in the oral care regimen at HCT centers.⁸⁰ Removable prostheses should be cleaned manually and soaked overnight in a disinfecting solution.

There are no universally agreed upon indications for antibiotic prophylaxis before dental treatment in transplant patients, and this remains an area of debate.⁷⁹ For cardiac transplant patients, the American Heart Association's (AHA's) prevention of infective endocarditis guidelines recommend antibiotic prophylaxis in cardiac transplant recipients who develop cardiac valvulopathy.⁸¹ The AHA prophylaxis regimens have also been recommended for transplant patients on immunosuppressive therapy related to perceived risk for infection related to dental treatment, but this is controversial and there are no uniformly agreed upon standards.⁷⁹ The American Academy of Pediatric Dentistry (AAPD) also has published guidelines on the use of antibiotic prophylaxis for pediatric dental patients at risk for infection (including transplant recipients on immunosuppressive therapy) and recommends considering prescribing prophylactic antibiotics according to the AHA guidelines.^{82,83}

Risk Assessment. The most important aspect of assessing an individual patient's risk is knowing his or her medical history and status.^{84,85} This includes, but is not limited to, the indication for transplantation, organ function status, current medications, pertinent laboratory results, and the transplantation schedule and time line. It is essential that the dentist and transplant team establish communication so that pertinent clinical information can

be exchanged in a timely manner, whether by telephone or electronically via fax or email. Patients scheduled for organ transplantation may be at risk for bleeding because of antithrombotic therapy, anticoagulant therapy, advanced liver disease, or thrombocytopenia and therefore require careful evaluation of their medication history and partial thromboplastin time and prothrombin/international normalized ratio, as indicated.⁸⁰ Risk for infection in the pretransplant setting is generally not significantly different from the general population except in some patients with hematologic malignancies scheduled for HCT; when indicated, a complete blood count and absolute neutrophil count should be reviewed.⁸⁶

Pretransplant Dental Screening and Clearance. The objective of pretransplant dental screening and clearance is to reduce the risk of infection in the immediate post-transplant period of immunosuppression (Table 21.4).^{84,85} Although dental infection per se is an infrequently reported complication in organ transplantation, given the overall risk for infection in this high-risk population (and in particular with HCT), the ubiquity of dental infection in the general population, and the commitment and investment of resources for organ transplantation, dental screening is considered the standard of care at all transplant centers to reduce overall infection risk.⁸⁷⁻⁹¹ In a survey of U.S. transplant centers, there were a number of reports of dental infections, resulting in cancellation or postponement of a scheduled transplant procedure or being the cause of posttransplantation sepsis.⁸⁷

Although few data are available characterizing the dental status of organ transplant candidates, a number of factors may limit an individual's access to routine dental care and increase the likelihood of poor dental health, including the patient's medical status and complications, associated costs and lack of dental insurance, and disability and unemployment.⁸⁵ The joint task force of the Multinational Association of Supportive Care in Cancer/International Society of Oral Oncology (MASCC/ISOO) and the European Society for Blood and Marrow Transplantation (EBMT) recommend that all patients receive a comprehensive dental and oral evaluation as early as possible before HCT to identify and eliminate any potential odontogenic sources of infection.⁸⁰

The pretransplant dental screening should include a dental history, full-mouth series of dental radiographs, comprehensive soft tissue examination, charting of caries and defective restorations, vitality testing, periodontal evaluation, and assessment of third molars.^{28,85,90} All dental caries should be treated, with priority given to larger and symptomatic lesions when there are time or other (e.g., financial) limitations. Pulpal infections (i.e., caries into the pulp, spontaneous pain, periapical radiolucencies) are managed definitively with either endodontic therapy or extraction. Asymptomatic and stable (i.e., not increasing in size) radiographic periapical lesions in previously endodontically treated teeth pose minimal infection risk and require no additional treatment.⁹² Periodontal disease should be treated with deep scaling and root planing to remove all subgingival plaque and calculus.⁴⁷ Teeth with extensive periodontal bone loss, mobility, and overall poor prognosis should be extracted. Partially erupted third molars with a history of recurrent pericoronitis (infection and inflammation of partially overlying mucosa) should be considered for extraction.⁹³ All patients should receive a professional dental prophylaxis before transplantation. To date, in the United States, very little, if any, of this dental care related to preparation for organ transplantation is paid for by medical insurance; therefore out-of-pocket costs can be considerable, especially in patients without adequate dental insurance.⁸⁹ Of note, the amount of time available for completion of the pretransplant dental clearance can vary greatly depending on several factors, including the indication for transplantation and donor organ availability, in some cases necessitating scheduling of multiple visits in a short span of time and prioritizing certain items with the dental treatment plan.⁸⁴ All necessary dental treatment, and in particular extractions or other invasive procedures requiring significant time for healing, should be completed at least 2 weeks before transplantation.

The AAPD has published guidelines for pediatric patients undergoing HCT, which can be generalized to all pediatric organ transplant patients and are similar to those described above.⁸² Orthodontic appliances and space maintainers can be left in place if nonirritating and if the patient is maintaining adequate oral hygiene.

TABLE 21.4 Dental Management of Patients Being Prepared for Organ Transplantation

Potential Issue	Evaluation or Test	Treatment
Soft tissue infection	Examination, culture, biopsy	Definitive antimicrobial therapy; prophylactic therapy during high-risk periods
Dental caries	Clinical examination, full-mouth series of dental radiographs, vitality testing	Treat caries; provide endodontic therapy or extraction of abscessed and nonvital teeth and teeth with untreated periapical radiolucencies
Periodontal disease	Periodontal examination, radiographs	Scaling and root planing; extraction of mobile and hopeless teeth
Pericoronitis	History of recurrent pain or swelling associated with third molars, examination, radiographs	Extraction of associated third molar >2 weeks before transplant

Posttransplant Dental Care. The dental management of patients after transplantation can be divided into three phases: (1) the immediate posttransplant period; (2) the stable graft period; and (3) the chronic rejection period, or in HCT, the onset of significant GVHD requiring intensive and sustained immunosuppression (Table 21.5). Elective dental care is generally deferred during the immediate posttransplantation period because of profound immunosuppression and risk for infection. However, in the case of actual dental infection during this period, emergency care must be provided, following the same risk assessment principles as before transplantation. Infections should be managed aggressively and may require extended courses of antimicrobial therapy.^{45,94}

When the graft is stable and functioning and any acute rejection reaction has been controlled, the patient is considered to be in the stable phase. During this period, patients should receive routine dental care, including regular periodontal maintenance visits and active management of any evident dental pathology.

During chronic rejection or actively treated GVHD, transplant recipients are again at significantly higher risk for infection because of more intensive immunosuppressive

therapy. In addition, in solid organ transplant recipients with chronic rejection, organ function may be compromised such that their status may resemble the pretransplant period.

Oral Complications and Manifestations

Both infectious and noninfectious oral complications may be encountered in organ transplant patients (Table 21.6). Patient evaluation first and foremost begins with a comprehensive medical history, review of current medications, and assessment of pertinent laboratory results. Physical evaluation includes careful extraoral and intraoral examinations. Soft tissue abnormalities should be described based on location, size, color, consistency, and symptoms. Additional tests may be indicated, including microbiologic cultures, imaging, and tissue biopsy. Management of oral complications depends on an accurate and timely diagnosis and in some cases may require careful coordination with the primary transplantation team.

Oral Mucositis. Oral mucositis is a complication that is unique to HCT and related to both the intensive conditioning regimen as well as the course of methotrexate given for GVHD prophylaxis.^{95,96} Oral mucositis typically develops 7 to 10 days after initiation of conditioning and does not resolve until engraftment and resolution of a normal white blood cell count. Of note, the incidence and severity of mucositis are greatly lessened with reduced intensity conditioning regimens, as well as GVHD prophylaxis regimens that do not include methotrexate.⁹⁷ Clinical features are characterized by diffuse, nonspecific erythema and ulcerations of the nonkeratinized oral mucosa, compromising oral function and quality of life (Fig. 21.1). Lesions may affect the esophagus and make swallowing very painful.⁹⁸ Management includes diet modifications (e.g., soft, bland foods), palliative rinses (e.g., viscous lidocaine and various magic mouthwash

TABLE 21.5 Dental Management of Organ Transplant Recipients

IMMEDIATE POSTTRANSPLANTATION PERIOD (≤6 MONTHS)
Consultation with physician(s) 1. Defer routine dental treatment. 2. Continue oral hygiene procedures. 3. Provide emergency dental care as needed (eliminate infections).
STABLE GRAFT PERIOD
Consultation with physician(s) 1. Continue oral hygiene procedures. 2. Initiate active recall program with appointments every 3 to 6 months. 3. Monitor blood pressure in patients taking cyclosporine, tacrolimus, or prednisone; if blood pressure increases above established baseline, refer for medical evaluation. 4. Treat all new dental disease. 5. Examine for oral signs and symptoms of over-immunosuppression or graft rejection. 6. Alter drug selection or reduce dosage. <ol style="list-style-type: none"> a. Liver or kidney failure b. Avoid drugs toxic to liver or kidney (i.e., NSAIDs) c. Drug interactions
CHRONIC REJECTION PERIOD
Consultation with physician(s) 1. Follow recommendations for stable graft period. 2. Manage odontogenic infections aggressively. 3. Monitor medical status and medications; continually reassess risk.

NSAID, Nonsteroidal antiinflammatory drug.



FIG 21.1 Oral mucositis in a patient with acute myelogenous leukemia undergoing myeloablative allogeneic hematopoietic cell transplantation. (From Wingard JR, Gastineau DA, Leather HL, et al: *Hematopoietic stem cell transplantation: a handbook for clinicians*, ed 2, 2015, American Association of Blood Banks.)

TABLE 21.6 Oral Complications in Organ Transplantation

	Oral Complication	Diagnosis	Management
Infectious	Oral candidiasis	History and examination findings, culture, cytology	<ul style="list-style-type: none"> • Antifungal therapy • Disinfection of oral prostheses • Antiviral therapy
	Recrudescence HSV infection	History and examination findings, culture, cytology	
Noninfectious	Gingival overgrowth (cyclosporine associated)	History and examination findings	<ul style="list-style-type: none"> • Improve oral hygiene • Intensive periodontal therapy • Gingivectomy • Topical steroid therapy • Intralesional steroid therapy • mTOR inhibitor dose reduction or discontinuation if severe • Surgical excision
	Aphthous stomatitis (mTOR inhibitor-associated)	History and examination findings	
	Pyogenic granuloma (tacrolimus associated)	Examination and biopsy	
	Orofacial granulomatosis	Examination and biopsy	<ul style="list-style-type: none"> • Topical steroid therapy if symptomatic • No specific therapy indicated
Unique to HCT	Oral hairy leukoplakia	Examination and biopsy	<ul style="list-style-type: none"> • Refer to oncology center
	Cancer	Examination and biopsy	<ul style="list-style-type: none"> • Palliative care, analgesics, bland soft diet
	Oral mucositis	History and examination findings	<ul style="list-style-type: none"> • Topical tacrolimus ointment for lips • Topical steroid therapy for mucosal disease (e.g., dexamethasone solution)
	Graft-versus-host disease	History of allogeneic HCT, lichenoid white reticulations throughout oral mucosa and lips with varying degrees of erythema and ulceration, palatal superficial mucoceles common	<ul style="list-style-type: none"> • Xerostomia management with over-the-counter products and prescription sialogogue therapy, fluoride • Oral cancer screening

HCT, Hematopoietic cell transplantation; mTOR, mammalian target of rapamycin.

preparations), and systemic analgesics, in some cases requiring intensive opioids for adequate pain control.

Medication-Related Oral Complications. Aside from infectious complications, which are discussed later, several important potential oral complications are associated with immunosuppressive medications commonly used in organ transplantation. These complications are relatively uncommon and may not be dose related. An understanding of these conditions is essential for correct diagnosis and appropriate management.

Gingival Overgrowth. Cyclosporine-associated gingival overgrowth is a well-described condition characterized by fibroinflammatory enlargement of the gingiva, which appears edematous, swollen, and “overgrown,” often involving the interdental regions and extending on to the crowns of teeth in affected areas (Fig. 21.2).⁹⁹ Poor oral hygiene with dental plaque and calculus accumulations increases the risk of this complication significantly. Management includes intensive periodontal care, improved oral hygiene, and surgical excision by gingivectomy. Tacrolimus is not associated with gingival overgrowth, and with the overwhelming shift in use of tacrolimus over cyclosporine, gingival overgrowth is now infrequently encountered in this population.¹⁰⁰

Pyogenic Granuloma. Tacrolimus has been associated with nongingival soft tissue fibroinflammatory polyps that closely resemble pyogenic granulomas (Fig. 21.3).¹⁰¹ These lesions present as exophytic ulcerated fibrous lobulated



FIG 21.2 Cyclosporine-associated gingival overgrowth in a renal transplant recipient.

masses, measuring up to 3 to 4 cm in diameter. Symptoms are variable and are typically associated with secondary trauma. The pathophysiologic mechanisms and relationship with tacrolimus therapy remain unclear. Management is simple surgical excision, although some lesions may respond to intralesional steroid therapy.

mTOR Inhibitor-Associated Stomatitis. mTOR inhibitor therapy with sirolimus and everolimus is associated with



FIG 21.3 Multilobulated pyogenic granuloma-like lesion in a hematopoietic cell transplant recipient treated with tacrolimus. (From Antin J, Yolin-Raley D: *Manual of stem cell and bone marrow transplantation*, ed 2, 2013, Cambridge University Press.)

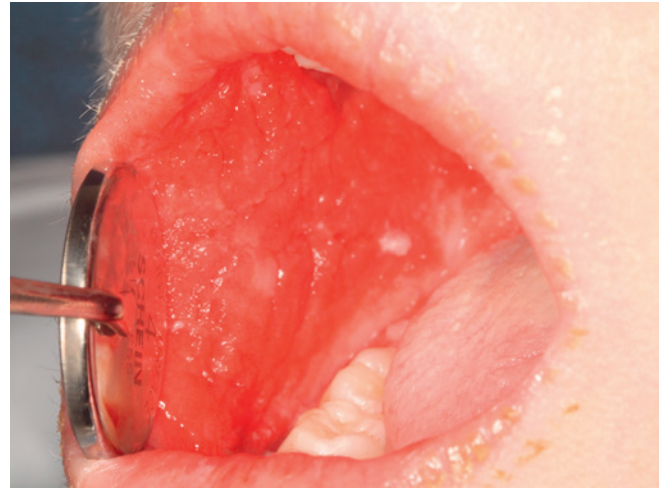

FIG 21.5 Orofacial granulomatosis-like features in a child after allogeneic hematopoietic cell transplantation.



FIG 21.4 Aphthous-like ulceration of the lower labial mucosa in a patient receiving mTOR inhibitor therapy. (From Sonis S, Treister N, Chawla S, et al: Preliminary characterization of oral lesions associated with inhibitors of mammalian target of rapamycin in cancer patients, *Cancer* 116:210-215, 2010.)



FIG 21.6 Oral hairy leukoplakia. (From Neville B, Damm D, Allen C, et al: *Oral and Maxillofacial Pathology*, ed 3, St. Louis, 2008, Saunders.)

development of painful aphthous-like oral ulcers, referred to as *mTOR inhibitor-associated stomatitis* (mIAS; Fig. 21.4).¹⁰²⁻¹⁰⁴ Ulcers typically develop within the first few weeks of initiating therapy and tend to diminish with time, even without reducing or discontinuing sirolimus. Although mIAS may present in a herpetiform pattern (akin to herpetiform aphthous stomatitis), the lip vermilion is never affected, and lesions tend to occur on the non-keratinized mucosa, generally distinguishing mIAS from recrudescing HSV infection. Management with topical and intralesional steroid therapy is generally effective,

although in some cases, mTOR inhibitor dose reduction may be considered.^{104,105}

Orofacial Granulomatosis-Like Lesions. Atypical orofacial granulomatosis-like oral lesions have been described in pediatric solid organ transplant recipients who received tacrolimus.^{106,107} Features include multiple spherical nodules of the tongue, mucosal fissuring, and lip swelling (Fig. 21.5). Food allergy has been proposed as a contributing factor, but very little is known about this condition.

Oral Hairy Leukoplakia. Oral hairy leukoplakia (OHL) is a painless, benign condition that presents as corrugated white plaques on the ventrolateral tongue that cannot be removed (Fig. 21.6).¹⁰⁸ It is associated with Epstein-Barr virus (EBV) replication and encountered in patients with immunodeficiency, including human immunodeficiency

virus (HIV) disease and organ transplant recipients. Biopsy is diagnostic and demonstrates characteristic changes of EBV infection. OHL is asymptomatic and does not require treatment.

Oral Infections. Oral infection is common in organ transplant recipients. Aside from odontogenic infections, already discussed under Dental Management, oral bacterial infections are exceedingly rare. The most frequently encountered oral infections in transplant recipients are candidiasis and recrudescence HSV, and although these rarely progress to systemic disease, both infections can cause significant morbidity and should be managed aggressively.

Candidiasis. In addition to medication-induced immunosuppression, other potential risk factors for development of oral candidiasis in organ transplant recipients include topical steroid use (e.g., treatment of oral GVHD, pulmonary inhalers), salivary gland hypofunction (related to medications and chronic GVHD), and use of removable oral prostheses. Infection typically presents with generalized white curdlike papules and plaques throughout the oral cavity (Fig. 21.7), although some cases are purely erythematous, presenting with generalized or more patchy redness (Fig. 21.8). Symptoms are variable but often include discomfort and burning, which may extend into the throat.

The diagnosis can typically be made clinically, but cytology or fungal culture may be helpful when there is uncertainty. Although topical antifungal therapy is available, systemic azole therapy with fluconazole is generally most effective. Because cyclosporine, tacrolimus, and sirolimus are metabolized through the cytochrome p450 pathway, fluconazole therapy may lead to increased levels of these drugs and therefore requires attentive monitoring or dosage adjustment. Removable oral prostheses should be cleaned and disinfected nightly. Antifungal prophylaxis

(e.g., fluconazole 100–200 mg once weekly) is effective in cases of chronic recurrent infection.^{75,94}

Herpes Simplex Virus. The risk of HSV recrudescence is so high that all seropositive organ transplant recipients receive acyclovir prophylaxis during periods of profound immunosuppression.^{74,109,110} Breakthrough infections despite active acyclovir therapy are possible because of profound immunosuppression, and even after acyclovir is discontinued, patients continue to be immunosuppressed and at risk for recrudescence. Lesions present as very painful irregularly shaped shallow ulcerations that can affect both keratinized and nonkeratinized surfaces, with the lips and tongue most frequently affected (Fig. 21.9).⁹⁴ The gold standard for diagnosis is viral culture, but therapy should be initiated empirically in case of suspected infection. Management requires systemic antiviral therapy with acyclovir or valacyclovir or rarely foscarnet in cases of



FIG 21.8 Erythematous candidiasis of the left buccal mucosa.



FIG 21.7 Pseudomembranous candidiasis of the right buccal mucosa. Angular cheilitis is also evident.



FIG 21.9 Recrudescence herpes simplex virus infection affecting the anterior and posterior tongue dorsum in an organ transplant recipient.

acyclovir resistance. Pain management may also be indicated.

Other Infrequent Infections. Invasive fungal infection (most frequently aspergillus) may present intraorally, typically in the maxilla as an extension of sinopulmonary involvement.^{67,75,94,110} This infection presents as an ulcerated mass and requires biopsy for diagnosis. Management includes a combination of surgery and intensive antifungal therapy. CMV reactivation rarely causes painful nonspecific ulcerations that require biopsy and immunostaining for diagnosis.¹¹¹ Management is ganciclovir.

Graft-Versus-Host Disease. Graft-versus-host disease is a major complication of allogeneic HCT and the leading cause of nonrelapse mortality.¹¹² Although infrequently involved, oral features of acute GVHD are similar to those of erythema multiforme and are managed with systemic and topical steroids (Fig. 21.10).¹¹³ With chronic GVHD, in contrast, the oral cavity is one of the most frequently affected sites and can be a significant source of morbidity from oral discomfort and difficulty eating and drinking. Clinical features include oral mucosal lichenoid inflammation, with typical lichen planus–like changes and associated mouth discomfort and sensitivity (Fig. 21.11), salivary gland dysfunction with xerostomia and high risk for dental decay (Fig. 21.12), and less frequently fibrosis of oral and perioral tissues leading to limited mobility and function.¹¹⁴ Superficial mucoceles are a common feature characterized by superficial saliva-filled blisters that develop primarily on the palate caused by inflammation of minor salivary glands and do not generally require any specific therapy (Fig. 21.13). The lips are frequently affected, and although the hard palate is also frequently involved, lesions rarely extend to the soft palate or further posteriorly.



FIG 21.10 Oral features of acute graft-versus-host disease with diffuse ulcerations of the lips and tongue. (From Kuten-Shorrer M, Woo SB, Treister NS: Oral graft-versus-host disease, *Dent Clin North Am* 58:351-368, 2014.)

Management of oral chronic GVHD is directed at controlling symptoms and reducing the risk of complications (see Table 21.4).¹¹⁴ Oral mucosal disease can be effectively treated with topical steroids. The lips can be safely and effectively treated with topical tacrolimus ointment. Prescription topical fluoride should be prescribed for patients with significant salivary gland dysfunction, and all patients should see a dentist for a professional cleaning and routine dental radiographs once or twice per year.

Secondary Malignancy. Organ transplant patients are at increased risk for developing cancer.^{56,115,116} Patients

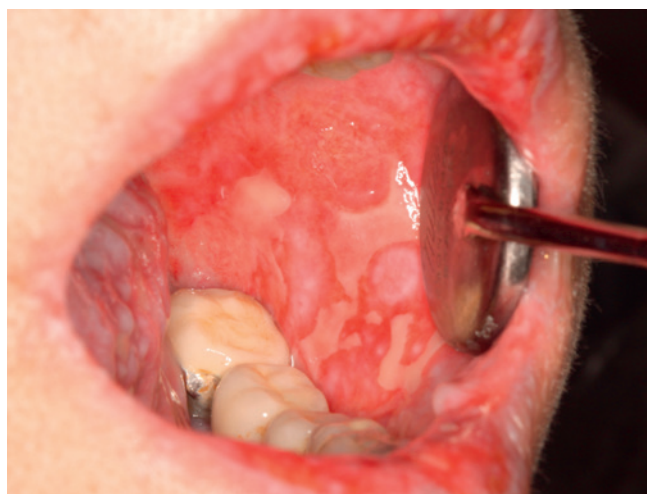

FIG 21.11 Typical pattern of dental caries in a patient with salivary gland chronic graft-versus-host disease. (From Kuten-Shorrer M, Woo SB, Treister NS: Oral graft-versus-host disease, *Dent Clin North Am* 58:351-368, 2014.)



FIG 21.12 Graft-versus-host disease in recipient of allogeneic bone marrow transplant. The maxillary gingiva exhibits features consistent with desquamative gingivitis. (From Newman M, Takei H, Carranza F, et al: *Carranza's Clinical Periodontology*, ed 10, St. Louis, 2006, Saunders.)



FIG 21.13 Superficial mucocèles of the soft palate. (From Kuten-Shorrer M, Woo SB, Treister NS: Oral graft-versus-host disease, *Dent Clin North Am* 58:351-368, 2014.)



FIG 21.15 Posttransplant lymphoproliferative disease presenting as a palatal ulceration in a patient after hematopoietic cell transplantation.



FIG 21.14 Extramedullary relapse of acute myeloid leukemia presenting as a palatal ulceration in a patient after hematopoietic cell transplantation.



FIG 21.16 Squamous cell carcinoma of the right buccal mucosa arising in the background of active oral chronic graft-versus-host disease in a patient after hematopoietic cell transplantation. (From Bruch JM, Treister NS: *Clinical oral medicine and pathology*, New York, 2010, Humana Press.)

with hematologic malignancies who undergo HCT remain at risk for relapse of primary disease, typically within the first 1 to 2 years after transplantation.⁵⁵ Extramedullary disease can present in the oral cavity as a nonspecific mass or ulceration (Fig. 21.14).¹¹⁷ PTLD can similarly present in the oral cavity as a mass or ulceration (Fig. 21.15).¹¹⁸ Risk of oral cavity and lip squamous cell carcinoma (SCC) is increased significantly in posttransplant patients, with patients with GVHD after HCT being at particularly high risk.^{115,116,119} Oral SCC presents with the same clinical features as in the general population but may be difficult to diagnose in the context of active GVHD changes (Fig. 21.16). Management outcomes appear to be worse compared with nontransplant patients with oral SCC.^{116,119} All transplant patients require annual oral cavity cancer screening.⁷⁹

REFERENCES

1. Sayegh MH, Carpenter CB. Transplantation 50 years later—progress, challenges, and promises. *N Engl J Med*. 2004;351:2761-2766.
2. Wijdsicks EF, Varelas PN, Gronseth GS, et al. Evidence-based guideline update: determining brain death in adults: report of the Quality Standards Subcommittee of the American Academy of Neurology. *Neurology*. 2010;74:1911-1918.
3. Shrestha B, Haylor J, Raftery A. Historical perspectives in kidney transplantation: an updated review. *Prog Transplant*. 2015;25:64-69, 76.
4. Hart A, Smith JM, Skeans MA, et al. Kidney. *Am J Transplant*. 2016;16(suppl 2):11-46.

5. Toyoda Y, Guy TS, Kashem A. Present status and future perspectives of heart transplantation. *Circ J*. 2013;77:1097-1110.
6. Mehra MR, Kobashigawa J, Starling R, et al. Listing criteria for heart transplantation: International Society for Heart and Lung Transplantation guidelines for the care of cardiac transplant candidates—2006. *J Heart Lung Transplant*. 2006;25:1024-1042.
7. Colvin M, Smith JM, Skeans MA, et al. Heart. *Am J Transplant*. 2016;16(suppl 2):115-140.
8. Bhat M, Al-Busafi S, Deschenes M, et al. Care of the liver transplant patient. *Can J Gastroenterol Hepatol*. 2014;28:213-219.
9. Dutkowski P, Linecker M, DeOliveira ML, et al. Challenges to liver transplantation and strategies to improve outcomes. *Gastroenterology*. 2015;148:307-323.
10. Valentine E, Gregorits M, Gutsche JT, et al. Clinical update in liver transplantation. *J Cardiothorac Vasc Anesth*. 2013;27:809-815.
11. Kim WR, Lake JR, Smith JM, et al. Liver. *Am J Transplant*. 2016;16(suppl 2):69-98.
12. Kelly WD, Lillehei RC, Merkel FK, et al. Allograft transplantation of the pancreas and duodenum along with the kidney in diabetic nephropathy. *Surgery*. 1967;61:827-837.
13. Dholakia S, Mittal S, Quiroga I, et al. Pancreas transplantation: past, present, future. *Am J Med*. 2016;129:667-673.
14. White SA, Shaw JA, Sutherland DE. Pancreas transplantation. *Lancet*. 2009;373:1808-1817.
15. Kandaswamy R, Skeans MA, Gustafson SK, et al. Pancreas. *Am J Transplant*. 2016;16(suppl 2):47-68.
16. Kerr HR, Hatipoglu B, Krishnamurthi V. Pancreas transplant for diabetes mellitus. *Cleve Clin J Med*. 2015;82:738-744.
17. Maffi P, Secchi A. Clinical results of islet transplantation. *Pharmacol Res*. 2015;98:86-91.
18. Health Quality O. Pancreas islet transplantation for patients with type 1 diabetes mellitus: a clinical evidence review. *Ont Health Technol Assess Ser*. 2015;15:1-84.
19. Kotloff RM, Thabut G. Lung transplantation. *Am J Respir Crit Care Med*. 2011;184:159-171.
20. Hardy JD, Webb WR, Dalton ML Jr, et al. Lung homotransplantation in man. *JAMA*. 1963;186:1065-1074.
21. Valapour M, Skeans MA, Smith JM, et al. Lung. *Am J Transplant*. 2016;16(suppl 2):141-168.
22. Kreider M, Kotloff RM. Selection of candidates for lung transplantation. *Proc Am Thorac Soc*. 2009;6:20-27.
23. Orens JB, Estenne M, Arcasoy S, et al. International guidelines for the selection of lung transplant candidates: 2006 update—a consensus report from the Pulmonary Scientific Council of the International Society for Heart and Lung Transplantation. *J Heart Lung Transplant*. 2006;25:745-755.
24. Rege A, Sudan D. Intestinal transplantation. *Best Pract Res Clin Gastroenterol*. 2016;30:319-335.
25. Smith JM, Skeans MA, Horslen SP, et al. Intestine. *Am J Transplant*. 2016;16(suppl 2):99-114.
26. Thomas ED, Lochte HL Jr, Lu WC, et al. Intravenous infusion of bone marrow in patients receiving radiation and chemotherapy. *N Engl J Med*. 1957;257:491-496.
27. Leger CS, Nevill TJ. Hematopoietic stem cell transplantation: a primer for the primary care physician. *CMAJ*. 2004;170:1569-1577.
28. Epstein JB, Raber-Durlacher JE, Wilkins A, et al. Advances in hematologic stem cell transplant: an update for oral health care providers. *Oral Surg Oral Med Oral Pathol Oral Radiol Endod*. 2009;107:301-312.
29. Horowitz MM, Gale RP, Sondel PM, et al. Graft-versus-leukemia reactions after bone marrow transplantation. *Blood*. 1990;75:555-562.
30. Antin JH. Clinical practice. Long-term care after hematopoietic-cell transplantation in adults. *N Engl J Med*. 2002;347:36-42.
31. Current uses and outcomes of hematopoietic stem cell transplantation: CIBMTR Summary Slides; 2015. Available at: <http://www.cibmtr.org>. 2015. 2016. At <http://www.cibmtr.org>.
32. Copelan EA. Hematopoietic stem-cell transplantation. *N Engl J Med*. 2006;354:1813-1826.
33. Swearingen B, Ravindra K, Xu H, et al. Science of composite tissue allotransplantation. *Transplantation*. 2008;86:627-635.
34. Dubernard JM, Owen E, Lefrancois N, et al. First human hand transplantation. Case report. *Transpl Int*. 2000;13(suppl 1):S521-S524.
35. Dubernard JM, Lengele B, Morelon E, et al. Outcomes 18 months after the first human partial face transplantation. *N Engl J Med*. 2007;357:2451-2460.
36. Chinen J, Buckley RH. Transplantation immunology: solid organ and bone marrow. *J Allergy Clin Immunol*. 2010;125:S324-S335.
37. Eng HS, Leffell MS. Histocompatibility testing after fifty years of transplantation. *J Immunol Methods*. 2011;369:1-21.
38. Kissmeyer-Nielsen F, Olsen S, Petersen VP, et al. Hyperacute rejection of kidney allografts, associated with pre-existing humoral antibodies against donor cells. *Lancet*. 1966;2:662-665.
39. Bray RA, Hurley CK, Kamani NR, et al. National marrow donor program HLA matching guidelines for unrelated adult donor hematopoietic cell transplants. *Biol Blood Marrow Transplant*. 2008;14:45-53.
40. Brown RS, Belton AM, Martin JM, et al. Evolution of quality at the Organ Center of the Organ Procurement and Transplantation Network/United Network for Organ Sharing. *Prog Transplant*. 2009;19:221-226.
41. The Center for International Blood and Marrow Transplant Research. At <https://www.cibmtr.org/>.
42. Stites E, Le Quintrec M, Thurman JM. The complement system and antibody-mediated transplant rejection. *J Immunol*. 2015;195:5525-5531.
43. Fischer SA, Lu K, Practice ASTIDCo. Screening of donor and recipient in solid organ transplantation. *Am J Transplant*. 2013;13(suppl 4):9-21.
44. Wong CJ, Pagalilauan G. Primary care of the solid organ transplant recipient. *Med Clin North Am*. 2015;99:1075-1103.
45. Fishman JA. Infection in solid-organ transplant recipients. *N Engl J Med*. 2007;357:2601-2614.

46. Pagalilauan GL, Limaye AP. Infections in transplant patients. *Med Clin North Am.* 2013;97:581-600, x.
47. Akintoye SO, Brennan MT, Graber CJ, et al. A retrospective investigation of advanced periodontal disease as a risk factor for septicemia in hematopoietic stem cell and bone marrow transplant recipients. *Oral Surg Oral Med Oral Pathol Oral Radiol Endod.* 2002;94:581-588.
48. Graber CJ, de Almeida KN, Atkinson JC, et al. Dental health and viridans streptococcal bacteremia in allogeneic hematopoietic stem cell transplant recipients. *Bone Marrow Transplant.* 2001;27:537-542.
49. Sawinski D, Goral S. BK virus infection: an update on diagnosis and treatment. *Nephrol Dial Transplant.* 2015;30:209-217.
50. Saemann M, Horl WH. Urinary tract infection in renal transplant recipients. *Eur J Clin Invest.* 2008;38(suppl 2):58-65.
51. Storek J. Immunological reconstitution after hematopoietic cell transplantation - its relation to the contents of the graft. *Expert Opin Biol Ther.* 2008;8:583-597.
52. Casey MJ, Meier-Kriesche HU. Calcineurin inhibitors in kidney transplantation: friend or foe? *Curr Opin Nephrol Hypertens.* 2011;20:610-615.
53. Engels EA, Pfeiffer RM, Fraumeni JF Jr, et al. Spectrum of cancer risk among US solid organ transplant recipients. *JAMA.* 2011;306:1891-1901.
54. King GN, Healy CM, Glover MT, et al. Increased prevalence of dysplastic and malignant lip lesions in renal-transplant recipients. *N Engl J Med.* 1995;332:1052-1057.
55. Ades L, Guardiola P, Socie G. Second malignancies after allogeneic hematopoietic stem cell transplantation: new insight and current problems. *Blood Rev.* 2002;16:135-146.
56. Curtis RE, Rowlings PA, Deeg HJ, et al. Solid cancers after bone marrow transplantation. *N Engl J Med.* 1997;336:897-904.
57. Dierickx D, Tousseyn T, Gheysens O. How I treat posttransplant lymphoproliferative disorders. *Blood.* 2015;126:2274-2283.
58. Dierickx D, Tousseyn T, Sagaert X, et al. Single-center analysis of biopsy-confirmed posttransplant lymphoproliferative disorder: incidence, clinicopathological characteristics and prognostic factors. *Leuk Lymphoma.* 2013;54:2433-2440.
59. Opelz G, Dohler B. Lymphomas after solid organ transplantation: a collaborative transplant study report. *Am J Transplant.* 2004;4:222-230.
60. Bolanos-Meade J, Vogelsang GB. Acute graft-versus-host disease. *Clin Adv Hematol Oncol.* 2004;2:672-682.
61. Cutler C, Antin JH. Chronic graft-versus-host disease. *Curr Opin Oncol.* 2006;18:126-131.
62. Pallua S, Giesinger J, Oberguggenberger A, et al. Impact of GvHD on quality of life in long-term survivors of haematopoietic transplantation. *Bone Marrow Transplant.* 2010;45:1534-1539.
63. Sharma A, Armstrong AE, Posner MP, et al. Graft-versus-host disease after solid organ transplantation: a single center experience and review of literature. *Ann Transplant.* 2012;17:133-139.
64. Wall A, Bueno E, Pomahac B, et al. Intraoral features and considerations in face transplantation. *Oral Dis.* 2016;22:93-103.
65. Jagasia MH, Greinix HT, Arora M, et al. National Institutes of Health Consensus Development Project on Criteria for Clinical Trials in Chronic Graft-versus-Host Disease: I. The 2014 Diagnosis and Staging Working Group report. *Biol Blood Marrow Transplant.* 2015;21:389-401.e1.
66. Shulman HM, Cardona DM, Greenson JK, et al. NIH Consensus development project on criteria for clinical trials in chronic graft-versus-host disease: II. The 2014 Pathology Working Group Report. *Biol Blood Marrow Transplant.* 2015;21:589-603.
67. Ruping MJ, Vehreschild JJ, Cornely OA. Patients at high risk of invasive fungal infections: when and how to treat. *Drugs.* 2008;68:1941-1962.
68. Cutler C, Miklos D, Kim HT, et al. Rituximab for steroid-refractory chronic graft-versus-host disease. *Blood.* 2006;108:756-762.
69. Greinix HT, Volc-Platzer B, Rabitsch W, et al. Successful use of extracorporeal photochemotherapy in the treatment of severe acute and chronic graft-versus-host disease. *Blood.* 1998;92:3098-3104.
70. Koreth J, Matsuoka K, Kim HT, et al. Interleukin-2 and regulatory T cells in graft-versus-host disease. *N Engl J Med.* 2011;365:2055-2066.
71. Green M. Introduction: Infections in solid organ transplantation. *Am J Transplant.* 2013;13(suppl 4): 3-8.
72. Blumberg EA, Danziger-Isakov L, Kumar D, et al. Foreword: Guidelines 3. *Am J Transplant.* 2013;13(suppl 4):1-2.
73. Rubin RH. Preemptive therapy in immunocompromised hosts. *N Engl J Med.* 1991;324:1057-1059.
74. Wilck MB, Zuckerman RA, Practice ASTIDCo. Herpes simplex virus in solid organ transplantation. *Am J Transplant.* 2013;13(suppl 4):121-127.
75. Pappas PG, Kauffman CA, Andes D, et al. Clinical practice guidelines for the management of candidiasis: 2009 update by the Infectious Diseases Society of America. *Clin Infect Dis.* 2009;48:503-535.
76. Silveira FP, Kusne S, Practice ASTIDCo. Candida infections in solid organ transplantation. *Am J Transplant.* 2013;13(suppl 4):220-227.
77. Kelly DA, Bucuvalas JC, Alonso EM, et al. Long-term medical management of the pediatric patient after liver transplantation: 2013 practice guideline by the American Association for the Study of Liver Diseases and the American Society of Transplantation. *Liver Transpl.* 2013;19:798-825.
78. Lucey MR, Terrault N, Ojo L, et al. Long-term management of the successful adult liver transplant: 2012 practice guideline by the American Association for the Study of Liver Diseases and the American Society of Transplantation. *Liver Transpl.* 2013;19:3-26.
79. Majhail NS, Rizzo JD, Lee SJ, et al. Recommended screening and preventive practices for long-term survivors after hematopoietic cell transplantation. *Biol Blood Marrow Transplant.* 2012;18:348-371.

80. Elad S, Raber-Durlacher JE, Brennan MT, et al. Basic oral care for hematology-oncology patients and hematopoietic stem cell transplantation recipients: a position paper from the joint task force of the Multinational Association of Supportive Care in Cancer/International Society of Oral Oncology (MASCC/ISOO) and the European Society for Blood and Marrow Transplantation (EBMT). *Support Care Cancer*. 2015;23:223-236.
81. Wilson W, Taubert KA, Gewitz M, et al. Prevention of infective endocarditis: guidelines from the American Heart Association: a guideline from the American Heart Association Rheumatic Fever, Endocarditis, and Kawasaki Disease Committee, Council on Cardiovascular Disease in the Young, and the Council on Clinical Cardiology, Council on Cardiovascular Surgery and Anesthesia, and the Quality of Care and Outcomes Research Interdisciplinary Working Group. *Circulation*. 2007;116:1736-1754.
82. American Academy of Pediatric D. Guideline on dental management of pediatric patients receiving chemotherapy, hematopoietic cell transplantation, and/or radiation. *Pediatr Dent*. 2013;35:E185-E193.
83. American Academy on Pediatric Dentistry Clinical Affairs C, American Academy on Pediatric Dentistry Council on Clinical A. Guideline on antibiotic prophylaxis for dental patients at risk for infection. *Pediatr Dent*. 2008;30:215-218.
84. Brennan MT, Woo SB, Lockhart PB. Dental treatment planning and management in the patient who has cancer. *Dent Clin North Am*. 2008;52:19-37, vii.
85. Guggenheimer J, Eghtesad B, Stock DJ. Dental management of the (solid) organ transplant patient. *Oral Surg Oral Med Oral Pathol Oral Radiol Endod*. 2003;95:383-389.
86. Wingard JR, Hsu J, Hiemenz JW. Hematopoietic stem cell transplantation: an overview of infection risks and epidemiology. *Infect Dis Clin North Am*. 2010;24:257-272.
87. Guggenheimer J, Mayher D, Eghtesad B. A survey of dental care protocols among US organ transplant centers. *Clin Transplant*. 2005;19:15-18.
88. Reyna J, Richardson JM, Mattox DE, et al. Head and neck infection after renal transplantation. *JAMA*. 1982;247:3337-3339.
89. Mawardi H, Manlove AE, Elting LS, et al. Cost analysis of dental services needed before hematopoietic cell transplantation. *Oral Surg Oral Med Oral Pathol Oral Radiol*. 2014;117:59-66.
90. Woo SB, Matin K. Off-site dental evaluation program for prospective bone marrow transplant recipients. *J Am Dent Assoc*. 1997;128:189-193.
91. Raber-Durlacher JE, Laheij AM, Epstein JB, et al. Periodontal status and bacteremia with oral viridans streptococci and coagulase negative staphylococci in allogeneic hematopoietic stem cell transplantation recipients: a prospective observational study. *Support Care Cancer*. 2013;21:1621-1627.
92. Peters E, Monopoli M, Woo SB, et al. Assessment of the need for treatment of postendodontic asymptomatic periapical radiolucencies in bone marrow transplant recipients. *Oral Surg Oral Med Oral Pathol*. 1993;76:45-48.
93. Ohman D, Bjork Y, Bratel J, et al. Partially erupted third molars as a potential source of infection in patients receiving peripheral stem cell transplantation for malignant diseases: a retrospective study. *Eur J Oral Sci*. 2010;118:53-58.
94. Palmason S, Marty FM, Treister NS. How do we manage oral infections in allogeneic stem cell transplantation and other severely immunocompromised patients? *Oral Maxillofac Surg Clin North Am*. 2011;23:579-599, vii.
95. Bensinger W, Schubert M, Ang KK, et al. NCCN Task Force Report. prevention and management of mucositis in cancer care. *J Natl Compr Canc Netw*. 2008;6(suppl 1):S1-S21, quiz S22-S24.
96. Scully C, Sonis S, Diz PD. Oral mucositis. *Oral Dis*. 2006;12:229-241.
97. Cutler C, Kim HT, Hochberg E, et al. Sirolimus and tacrolimus without methotrexate as graft-versus-host disease prophylaxis after matched related donor peripheral blood stem cell transplantation. *Biol Blood Marrow Transplant*. 2004;10:328-336.
98. Villa A, Sonis ST. Mucositis: pathobiology and management. *Curr Opin Oncol*. 2015;27:159-164.
99. Hood KA. Drug-induced gingival hyperplasia in transplant recipients. *Prog Transplant*. 2002;12:17-21, quiz 22-23.
100. Walker RG, Cottrell S, Sharp K, et al. Conversion of cyclosporine to tacrolimus in stable renal allograft recipients: quantification of effects on the severity of gingival enlargement and hirsutism and patient-reported outcomes. *Nephrology (Carlton)*. 2007;12:607-614.
101. Al-Mohaya M, Treister N, Al-Khadra O, et al. Calcineurin inhibitor-associated oral inflammatory polyps after transplantation. *J Oral pathol Med*. 2007;36:570-574.
102. MacDonald AS, Group RGS. A worldwide, phase III, randomized, controlled, safety and efficacy study of a sirolimus/cyclosporine regimen for prevention of acute rejection in recipients of primary mismatched renal allografts. *Transplantation*. 2001;71:271-280.
103. Sonis S, Treister N, Chawla S, et al. Preliminary characterization of oral lesions associated with inhibitors of mammalian target of rapamycin in cancer patients. *Cancer*. 2010;116:210-215.
104. Villa A, Aboalela A, Luskin KA, et al. Mammalian target of rapamycin inhibitor-associated stomatitis in hematopoietic stem cell transplantation patients receiving sirolimus prophylaxis for graft-versus-host disease. *Biol Blood Marrow Transplant*. 2015;21:503-508.
105. Chuang P, Langone AJ. Clobetasol ameliorates aphthous ulceration in renal transplant patients on sirolimus. *Am J Transplant*. 2007;7:714-717.
106. Saalman R, Sundell S, Kullberg-Lindh C, et al. Long-standing oral mucosal lesions in solid organ-transplanted children—a novel clinical entity. *Transplantation*. 2010;89:606-611.
107. Vivas AP, Bomfin LE, Costa WI Jr, et al. Oral granulomatosis-like lesions in liver-transplanted pediatric patients. *Oral Dis*. 2014;20:e97-e102.

108. Greenspan JS, Greenspan D, Webster-Cyriaque J. Hairy leukoplakia; lessons learned: 30-plus years. *Oral Dis.* 2016;22(suppl 1):120-127.
109. Avery RK. Prophylactic strategies before solid-organ transplantation. *Curr Opin Infect Dis.* 2004;17:353-356.
110. Center for International Blood and Marrow Transplant Research, National Marrow Donor Program, et al. Guidelines for preventing infectious complications among hematopoietic cell transplant recipients: a global perspective. *Bone Marrow Transplant.* 2009;44:453-558.
111. Tarkan JL, Woo SB, Pavlakis M, et al. Spotting the owl: surreptitious cytomegalovirus disease in a renal transplant recipient. *Clin Transplant.* 2008;22:391-395.
112. Flowers ME, Martin PJ. How we treat chronic graft-versus-host disease. *Blood.* 2015;125:606-615.
113. Ion D, Stevenson K, Woo SB, et al. Characterization of oral involvement in acute graft-versus-host disease. *Biol Blood Marrow Transplant.* 2014;20:1717-1721.
114. Treister N, Duncan C, Cutler C, et al. How we treat oral chronic graft-versus-host disease. *Blood.* 2012;120:3407-3418.
115. Curtis RE, Metayer C, Rizzo JD, et al. Impact of chronic GVHD therapy on the development of squamous-cell cancers after hematopoietic stem-cell transplantation: an international case-control study. *Blood.* 2005;105:3802-3811.
116. Preciado DA, Matas A, Adams GL. Squamous cell carcinoma of the head and neck in solid organ transplant recipients. *Head Neck.* 2002;24:319-325.
117. Bakst RL, Tallman MS, Douer D, et al. How I treat extramedullary acute myeloid leukemia. *Blood.* 2011;118:3785-3793.
118. Elad S, Meyerowitz C, Shapira MY, et al. Oral posttransplantation lymphoproliferative disorder: an uncommon site for an uncommon disorder. *Oral Surg Oral Med Oral Pathol Oral Radiol Endod.* 2008;105:59-64.
119. Mawardi H, Elad S, Correa ME, et al. Oral epithelial dysplasia and squamous cell carcinoma following allogeneic hematopoietic stem cell transplantation: clinical presentation and treatment outcomes. *Bone Marrow Transplant.* 2011;46:884-891.

PART VIII

Hematologic and Oncologic Disease

Disorders of Red Blood Cells

DEFINITION

Disorders of the red blood cells (RBCs) are of clinical importance in dental practice for several reasons. First, the dentist serves an important role in detecting patients with previously undiagnosed anemia through history, clinical examination, and the results of screening laboratory tests. These screening procedures should lead to prompt referral to a physician and the establishment of the diagnosis. Clinical recognition of anemia can significantly affect morbidity and mortality risks because anemia often occurs as an underlying condition that requires attention and medical treatment. Also, anemia is an independent risk factor for adverse cardiovascular outcomes (i.e., acute myocardial infarction and death) in a variety of patient populations (as defined by chronic kidney disease, acute coronary syndrome, or old age).^{1,2,3,4}

Anemia, which is defined as a reduction in the oxygen-carrying capacity of the blood, is usually associated with a decreased number of circulating RBCs or an abnormality in the hemoglobin (Hb) contained within the RBCs (Fig. 22.1). Anemia is not a disease but rather a symptom complex that may result from one of three underlying causes: (1) decreased production of RBCs (iron deficiency, folate deficiency, pernicious anemia), (2) blood loss, or (3) increased rate of destruction of circulating RBCs (hypersplenism, autoimmune destruction).

Oxygen demand (hypoxia) serves as the stimulus for erythropoiesis (RBC production). The kidney serves as the primary sensor for determining the level of oxygenation. If the level is low, the kidney releases erythropoietin, a hormone that stimulates the bone marrow to release RBCs. Hb, the oxygen-carrying molecule of RBCs, consists of two pairs of globin chains (i.e., α plus β , δ , or γ) that form a shell around four oxygen-binding heme groups. The normal RBC is about 33% Hb by volume.

COMPLICATIONS: Anemia increases the risk for acute myocardial infarction, chronic kidney disease, acute coronary syndrome, and death. Pernicious anemia is associated with increased risk of gastric carcinoma. Sick cell anemia is associated with increased risk of stroke, infection, osteonecrosis of the hip and shoulder joints, liver disease, hypertension, and sudden death from arrhythmias. Aplastic anemia is associated with bleeding issues, infection, and death.

TYPES OF ANEMIA

Iron Deficiency Anemia

Iron deficiency anemia is a microcytic anemia (Fig. 22.2) that can be caused by excessive blood loss, poor iron intake, poor iron absorption, or increased demand for iron.

Folate Deficiency Anemia and Pernicious Anemia

Vitamin B₁₂ (cobalamin) and folic acid are needed for RBC formation and growth within bone marrow. A deficiency in daily intake or absorption of these vitamins can result in anemia.

Hemolytic Anemia

Hemolytic anemias consist of sickle cell anemia, thalassemia, and glucose-6-phosphate dehydrogenase (G6PD) deficiency. They are commonly caused by immune attack, extrinsic factors (infection, splenomegaly, drugs, eclampsia), disorders of the RBC membrane (spherocytosis), enzymopathies, and hemoglobinopathies.

Sickle Cell Anemia

The two most common types of sickle cell disorders are sickle cell trait and sickle cell (disease) anemia. Sick cell trait is the heterozygous state in which the affected person carries one gene for sickle cell hemoglobin (HbS), the result of substitution of a single amino acid—valine for glutamic acid—at the sixth residue of the β -hemoglobin chain. In patients with sickle cell anemia, more than 80% of the Hb is HbS. In contrast, the thalassemias, another type of hemoglobinopathy, are caused by deletions or mutations of the α - or β -globin gene that result in a defect in globin synthesis (reduced or absent synthesis of one or more globin chains).⁵

Glucose-6-Phosphate Dehydrogenase Deficiency

Glucose-6-phosphate dehydrogenase is an enzyme that enables the RBC to convert carbohydrates into energy via the hexose monophosphate shunt pathway.⁶ Blockade of this enzymatic pathway in persons with G6PD deficiency allows for production of methemoglobin and denatured Hb, which leads to cell membrane alterations and hemolysis of the cell (hemolytic anemia).^{7,8}

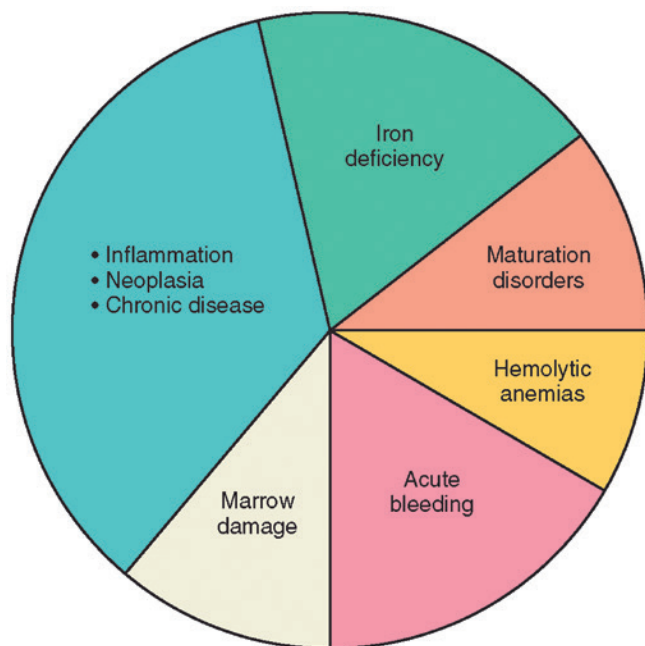

FIG 22.1 Relative frequencies of anemia in clinical practice. (Redrawn from Hillman RS, Finch CA, editors: *Red cell manual*, ed 7, Philadelphia, 1996, FA Davis.)

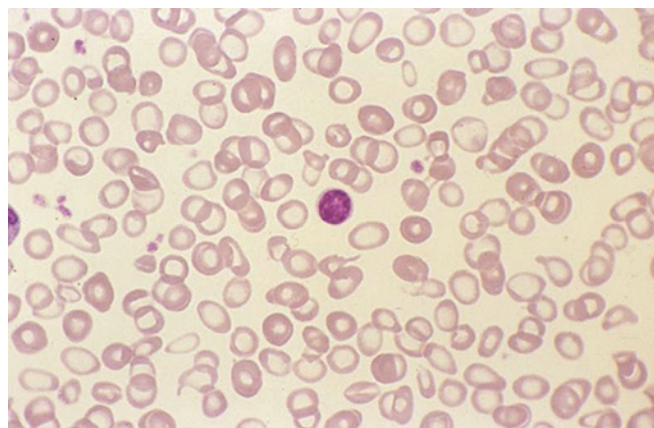

FIG 22.2 Microcytic anemia associated with iron deficiency. Peripheral blood smear shows red blood cells that are small and have marked hypochromic central pallor.

Aplastic Anemia

Aplastic anemia occurs when the bone marrow is unable to produce adequate numbers of RBCs, white blood cells (WBCs), and platelets because of an inability of the hematopoietic stem cells to proliferate, differentiate, or give rise to mature blood cells.⁹

EPIDEMIOLOGY

It is estimated that anemia affects 1.62 billion people globally and 3.4 million Americans, with the highest

TABLE 22.1 Types of Anemia

Classification by RBC Size and Shape		Cause
MICROCYTIC (MCV \leq80 FL*)		
Iron deficiency anemia		Decreased production of RBCs
Thalassemias		Defective hemoglobin synthesis
Lead poisoning		Inhibition of hemoglobin synthesis
NORMOCYTIC (MCV 80–100 FL*)		
Hemolytic anemia		Increased destruction of RBCs
• Sickle cell anemia		
• G6PD deficiency		
Aplastic anemia		Decreased production of RBCs
Renal failure		Decreased production of RBCs
Anemia of chronic disease		Decreased production of RBCs
MACROCYTIC (MCV $>$100 FL*)		
Pernicious anemia		Decreased production of RBCs
Folate deficiency		Decreased production of RBCs
Hypothyroidism		Decreased production of RBCs

*Also expressed in μm^3 units.

fL, Femtoliter; G6PD, glucose-6-phosphate dehydrogenase; MCV, mean corpuscular volume; RBC, red blood cell.

prevalence in young children.^{10,11} Approximately 4% of men and 8% of women in the United States have anemia, defined as Hb values below 13 g/dL for men and below 12 g/dL for women.^{11,12} In the United States, iron deficiency anemia is the most common type.¹³ Folate deficiency anemia occurs in about 4 of 100,000 people. The sickle cell trait is carried by approximately 8% to 10% of African Americans.^{14,15} In western Africa, 25% to 30% of the population may be carriers. Approximately 50,000 African Americans (\approx 0.003%–0.15%), or 1 in 600, have sickle cell anemia.^{16,17} If contemporary health care is not provided, 50% of persons with sickle cell anemia will die before the age of 30 years; however, because of advances in medical care, sickle cell anemia is now considered a chronic adult disease.¹⁸ The incidence of aplastic anemia in the United States is about 2 cases per 1 million persons per year.^{19,20,21} The incidence is about two times higher in Asia. Of the approximately 2000 patients treated in the average dental practice, about 12 men and 24 women will be anemic. In most of these patients, the condition may be undiagnosed.

ETIOLOGY

Anemia has numerous causes, including genetic disorders that produce aberrant RBCs that result in RBC destruction (hemolysis), nutritional disorders that limit the production of RBCs, immune-mediated disorders that result in attacks on RBCs, bleeding disorders that cause loss of RBCs, chronic diseases (e.g., rheumatoid arthritis), infections, and diseases of bone marrow (Table 22.1).

PATHOPHYSIOLOGY AND COMPLICATIONS

Iron Deficiency Anemia

Depletion of iron commonly occurs with blood loss caused by menstruation, pregnancy, or bleeding from the gastrointestinal (GI) tract. During pregnancy, the expectant mother experiences an increased demand for additional iron and vitamins to support the growth of her fetus, and unless sufficient amounts of these nutrients have been provided in some form, she may become anemic.²² Anemia in men usually indicates the presence of a serious underlying medical problem (e.g., GI bleeding, malignancy). Poor intake is more common in children who live in developing countries, where cereals and formula fortified with iron are not readily available. Malabsorption of iron can result from gastrectomy or intestinal disease that reduces absorption of iron from the duodenum and the jejunum. Increased demand is associated with chronic inflammation (autoimmune disease).

Folate Deficiency and Pernicious Anemia

Vitamin B₁₂ (cobalamin) and folic acid are needed for RBC formation and growth within bone marrow. Vitamin B₁₂ is a cofactor in methionine-associated enzymatic reactions required of protein synthesis and thus in the maturation of RBCs. Folate is needed for enzymatic reactions required for the synthesis of purines and pyrimidines of deoxyribonucleic acid (DNA) and ribonucleic acid (RNA) and thus for the synthesis of proteins. Risk factors for folate deficiency include poor diet (frequently encountered in poor individuals, older adults, and people who do not eat fresh fruits or leafy vegetables), alcoholism, history of malabsorption disorders, and pregnancy (especially during the third trimester).

Pernicious anemia is caused by a deficiency of intrinsic factor, a substance secreted by the gastric parietal cells that is necessary for absorption of vitamin B₁₂. Most patients with pernicious anemia have chronic atrophic gastritis with decreased intrinsic factor and hydrochloric acid secretion. Antibodies against parietal cells and intrinsic factor also are present in the sera of most patients.²³ This finding strongly suggests that the disease is of autoimmune origin.²⁴ Long-standing pernicious anemia is associated with increased risk for development of gastric carcinoma. In addition, an association with myxedema, rheumatoid arthritis, and neuropsychiatric and neuromuscular abnormalities (caused by a defect in myelin synthesis) has been reported.^{6,23}

Sickle Cell Anemia

Sickle cell hemoglobin is the result of substitution of a single amino acid—valine for glutamic acid—at the sixth residue of the β chain. Sickle cell disorders are distinguished by the number of globin genes affected. Whereas sickle cell trait is the heterozygous state in which the affected person carries one gene for HbS, sickle cell anemia is the homozygous state. In patients with sickle cell anemia,

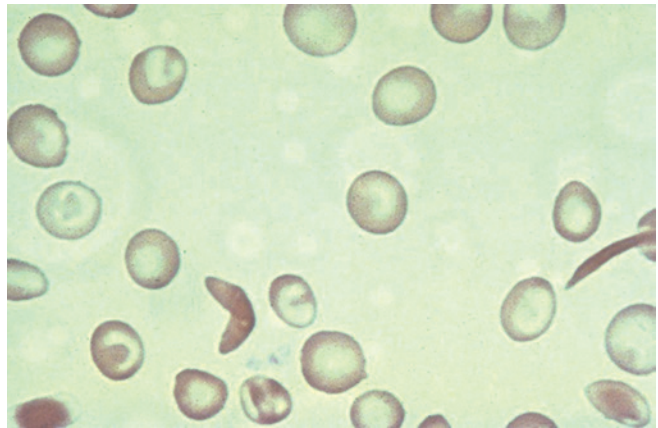

FIG 22.3 Sickle cell anemia. Peripheral blood smear shows characteristic abnormal sickle-shaped red blood cells.

more than 80% of the Hb is HbS. Distortion of the RBC into a sickled shape results from deoxygenation or decreased blood pH, causing partial crystallization of HbS, polymerization, and realignment of the defective Hb molecule (Fig. 22.3). Cellular rigidity and membrane damage occur, and irreversible sickling is the result. The net effects of these changes are erythrostasis, increased blood viscosity, reduced blood flow, hypoxia, increased adhesion of RBCs, vascular occlusion, and further sickling.^{14,15}

Complications of sickle cell anemia can occur at any age, but patients in the following age groups are more likely to manifest certain complications:

1. *Birth to 20 years of age*: painful events, stroke, acute chest syndrome (fever, chest pain, wheezing, cough, and hypoxia), acute anemia, and infection
2. *From 20 to 40 years of age*: osteonecrosis of hip and shoulder joints, leg ulcers, priapism, liver disease, and gallstones
3. *Older than 40 years of age*: pulmonary hypertension, nephropathy, proliferative retinopathy, and cardiac enlargement, heart murmurs, and sudden death from arrhythmias¹⁵

CLINICAL PRESENTATION

Signs and Symptoms

Symptoms of anemia occur in proportion to the rate of development of anemia; rapidly developing anemia has more profound features than slowly developing anemia. Because anemia develops slowly in most affected patients, few symptoms are typically experienced until the condition worsens. Usual symptoms include fatigue, lethargy, palpitations, shortness of breath, abdominal pain, bone pain, tinnitus, irritability, dizziness, tingling of fingers and toes, and muscular weakness.^{25,26} Specific to iron deficiency anemia are impaired immunity and resistance to infection and diminished exercise tolerance and work performance.²⁶

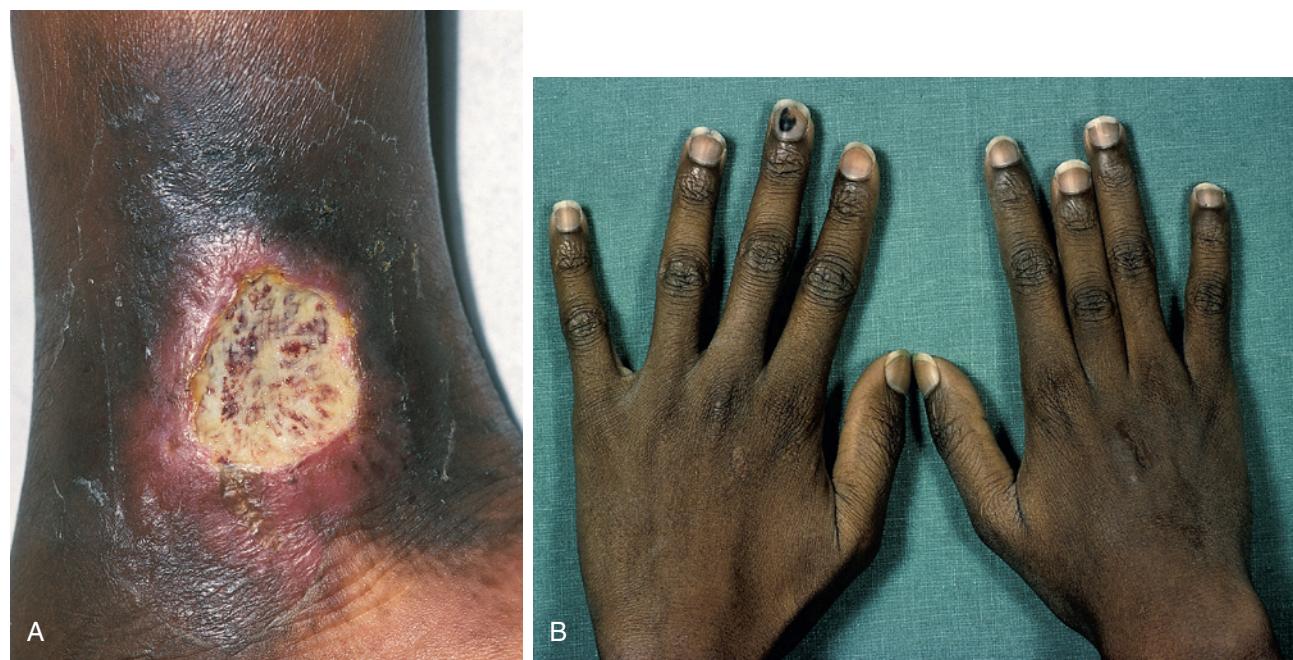

FIG 22.4 Sickle cell anemia may cause various complications. **A**, Leg ulcer secondary to a vasoocclusive attack. **B**, Growth deformation of the middle finger from dactylitis of the growth plate. (From Hoffbrand AV, Pettit JE: *Color atlas of clinical hematology*, ed 4, London, 2010, Mosby.)

Clinical features of G6PD deficiency involve acute intravascular hemolysis, which may be severe. Jaundice, palpitations, dyspnea, and dizziness may result. Clinical signs and symptoms of sickle cell anemia include jaundice, pallor, dactylitis (hand and foot warmth and tenderness), leg ulcers, organomegaly, cardiac failure, stroke, attacks of abdominal and bone pain (aseptic necrosis), and delays in growth and development (Fig. 22.4).^{18,27} The most common initial signs and symptoms of aplastic anemia are weakness, fatigue, headaches, dyspnea with exertion, petechiae, ecchymoses, epistaxis, metrorrhagia (bleeding between expected menstrual periods), and gingival bleeding. Infection is rare as an initial presentation, even in cases of severe neutropenia.^{19,20,21}

Signs of anemia may include jaundice; pallor; cracking, splitting, and spooning of the fingernails; increased size of the liver and spleen; lymphadenopathy; and blood in the stool. Premature graying of hair and yellowing of the skin (caused by jaundice) have been reported with pernicious anemia (Fig. 22.5).^{25,28} Patients with anemia also may describe a sore or painful tongue (glossitis), a smooth tongue, or redness of the tongue or cheilosis (Fig. 22.6). Some patients may complain of loss of taste sensation.

LABORATORY AND DIAGNOSTIC FINDINGS

A patient with signs or symptoms suggestive of anemia should be sent to a commercial laboratory for a complete blood count and differential or referred to a physician for evaluation. Hb level, hematocrit, and RBC indices (mean corpuscular volume [MCV], mean corpuscular

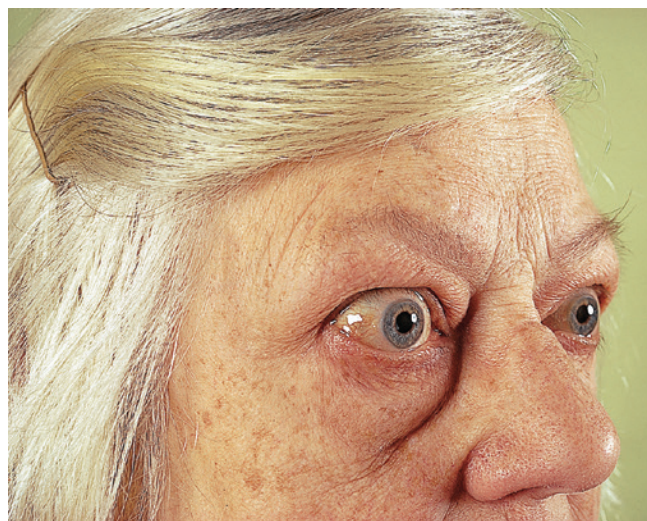

FIG 22.5 Pernicious anemia. This 38-year-old woman has blue eyes and vitiligo and shows premature graying of the hair—three features that are more common in patients with pernicious anemia than in control subjects. (From Hoffbrand AV, Pettit JE: *Color atlas of clinical hematology*, ed 4, London, 2010, Mosby.)

hemoglobin [MCH], RBC distribution width [RDW], and mean corpuscular hemoglobin concentration [MCHC]) are tests that are used to screen the patient.^{18,27} In addition, total WBC count and platelet count should be obtained to determine whether a generalized bone marrow defect has occurred and to evaluate for hypersegmented neutrophils (see Chapter 23).

Anemia is generally defined as Hb level less than 12 g/dL for women and less than 13 g/dL for men.^{11,12} In accordance with the size of RBCs, anemia is classified as microcytic (MCV <80 fL [or μm^3]), macrocytic (MCV >100 fL), or normocytic (MCV of 80–100 fL).²⁹ Whereas a reticulocyte count (based on percentage of RBCs) of less than 0.5% indicates inadequate RBC production in the bone marrow, a value greater than 1.5% indicates increased production in response to bleeding or destruction. Based on the absolute reticulocyte count in the presence of anemia, a value below 75,000/ μL indicates hypoproliferative anemias, and a value greater 100,000/ μL indicates hemolysis or an appropriate erythropoietic response.²⁹ To distinguish between the various types of anemias, key laboratory tests, as shown in Table 22.2, are performed.



FIG 22.6 Smooth red tongue and angular cheilitis in a patient found to have iron deficiency anemia.

Deficiencies in iron reveal a microcytic anemia, low serum ferritin, low serum iron, and high total iron-binding capacity (TIBC).³⁰ Deficiencies of vitamin B₁₂ and folic acid are associated with macrocytic anemia and the presence of hypersegmented polymorphonuclear leukocytes in the peripheral blood smear (Fig. 22.7). Measures of serum methylmalonic acid and homocysteine levels and serologic testing for parietal cell and intrinsic factor antibodies are used to further screen for the deficiency.^{6,23,31} Use of the serum cobalamin assay followed by the Schilling test helps to establish the diagnosis of pernicious anemia.^{6,22,23,32} For the Schilling test, the fasting patient receives a small oral dose of radioactive vitamin B₁₂ and then a larger dose of nonradioactive vitamin B₁₂ as a parenteral flush. At 24 hours, the amount of radioactive cyanocobalamin in the urine is measured. About 7% of the radioactive vitamin B₁₂ dose is excreted during the first 24 hours; however, persons with pernicious anemia excrete less than 3%.^{23,32} The Schilling test is now only used occasionally as serologic testing for parietal cell and intrinsic factor antibodies is commonly used to diagnose pernicious anemia.^{18,24}

Screening tests for Heinz bodies (Hb precipitates) (Fig. 22.8) or nicotinamide adenine dinucleotide phosphate (NADPH) may be used to detect G6PD deficiency. More sensitive tests use direct fluorescent measures of NADPH. Other tests used to detect this deficiency include the cyanide-ascorbate assay, the quantitative assay of G6PD, and G6PD-tetrazolium cytochemical test.^{7,32}

All African American patients should be asked whether sickle cell disease is present in their family histories. If the patient or family members have not been screened, the dentist should consider referring these individuals to their physicians for appropriate screening. This can be done in the dental office with the Sickledex test (Streck, Inc., Omaha, NE), in a commercial clinical laboratory, or by a physician. The Sickledex test uses deoxygenating agents, which will cause RBCs to sickle in shape.

TABLE 22.2 Laboratory Assessments to Aid in the Diagnosis of Anemia*

Type	Etiology	Tests to Discriminate Types of Anemia
Microcytic anemia	Iron deficiency	Serum iron, ferritin, TIBC, transferrin saturation, bone marrow aspirate; also, stool examination for occult blood
Macrocytic anemia	Folate deficiency	CBC, serum folate level
Macrocytic anemia	Pernicious anemia	CBC, serum vitamin B ₁₂ (cobalamin) assay levels, Schilling test, serum antiparietal cell, and intrinsic factor antibodies
Normocytic anemia	G6PD	Staining peripheral blood smear with methyl or crystal violet, cyanide-ascorbate assay, qualitative (fluorescent spot) test and quantitative test for G6PD, reticulocyte count, indirect bilirubin levels
Normocytic anemia	Sickle cell anemia	Sickledex, high-performance liquid chromatography, hemoglobin electrophoresis, reticulocyte count, indirect bilirubin levels
Normocytic anemia	Aplastic anemia	Erythropoietin levels, bone marrow aspirate

*MCH, Mean corpuscular hemoglobin; MCHC, mean corpuscular hemoglobin concentration; MCV, mean corpuscular volume has been assessed, and values indicate that anemia is present. These tests are ordered after the initial complete blood count (CBC) and differential, including red blood cell indices. G6PD, Glucose-6-phosphate dehydrogenase; TIBC, total iron-binding capacity.

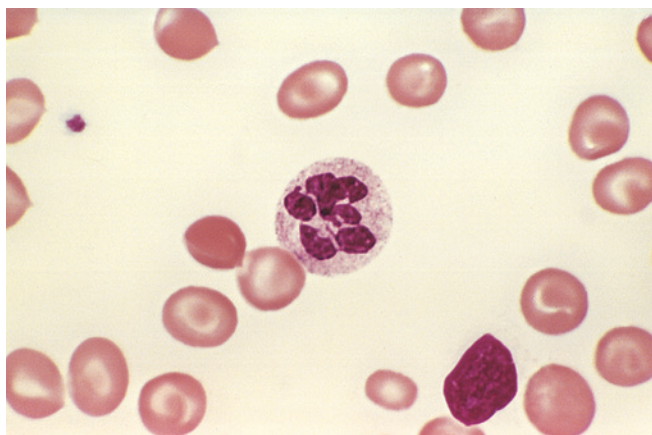

FIG 22.7 Megaloblastic anemia. Peripheral blood smear shows a hypersegmented neutrophil with a six-lobed nucleus. (From Kumar V, Abbas A, Fausto N: *Robbins & Cotran pathologic basis of disease*, ed 8, Philadelphia, Saunders, 2010. Courtesy of Dr. Robert W. McKenna, Department of Pathology, University of Texas Southwestern Medical School, Dallas, TX.)

Electrophoresis or high-performance liquid chromatography is performed as a confirmatory test.^{14,15,32}

The diagnosis of aplastic anemia is based on the presence of anemia (normochromic, normocytic), thrombocytopenia (normal sized platelets), neutropenia, and no abnormal cells in the leukocyte differential. The diagnosis is confirmed by findings on bone marrow biopsy and examination consisting of numerous bone spicules with empty fatty spaces and few hematopoietic cells. Lymphocytes, plasma cells, and mast cells are increased in numbers and represent more than 65% of the cells found in the samples.^{19,20,21}

MEDICAL MANAGEMENT

The goal of treatment is to eliminate the underlying cause. In microcytic anemia (iron deficiency), the physician should look for a source of bleeding. Iron deficiency associated with pregnancy often resolves after childbirth. In children, iron supplements (ferrous sulfate, 2–6 mg/kg/day) are recommended to arrest motor and cognitive impairment brought on by iron deficiency.^{13,33} In patients who have undergone a gastrectomy, iron supplements (ferrous sulfate, ferrous fumarate, or ferrous gluconate) are provided on a long-term basis. The preferred route of iron administration is oral. In cases in which blood loss is uncontrollable, iron cannot be absorbed, or iron is not tolerated, parenteral iron is given by either intravenous (IV) or intramuscular injection.¹³ In men, management often involves treatment of the underlying cause (e.g., peptic ulcer disease, GI malignancy).

Folate deficiency is managed by administering folic acid supplements and by increasing the intake of green, leafy vegetables and citrus fruits. In the case of poor intestinal absorption, replacement therapy with folic acid

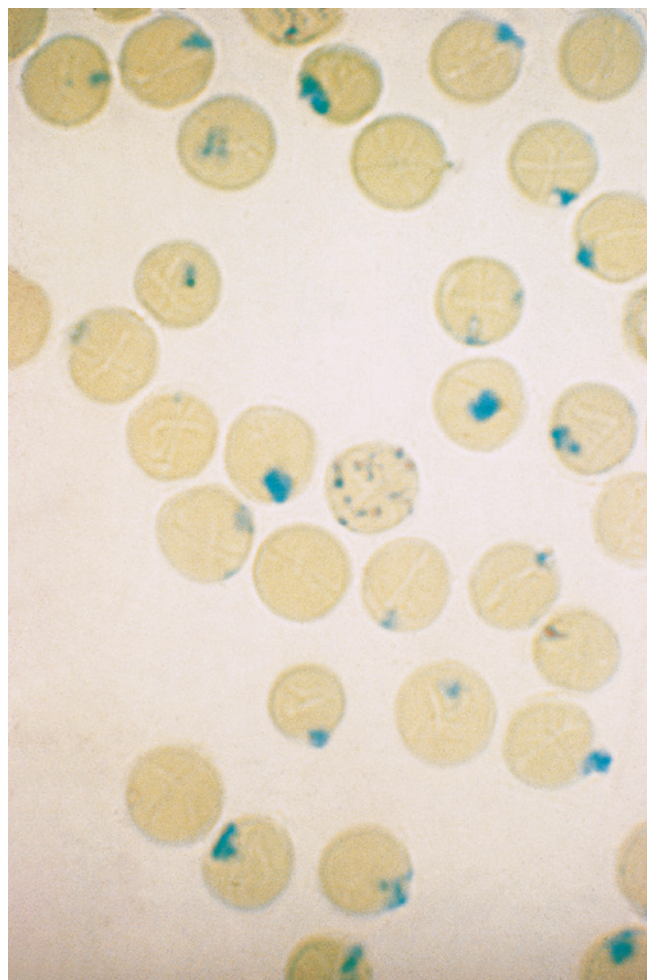

FIG 22.8 Deficiency of glucose 6-phosphate dehydrogenase: Peripheral blood film shows Heinz bodies in red blood cells and a single reticulocyte. (Supravital new methylene blue stain.) (From Hoffbrand AV, Pettit JE: *Color atlas of clinical hematology*, ed 4, London, 2010, Mosby.)

may be lifelong. Cyanocobalamin injections are used to treat patients with pernicious anemia. Injections generally are given daily for the first week and then are tapered eventually to once a month, as needed.²⁴

Management of sickle cell anemia includes routine prophylactic penicillin for infants and the early use of antibiotics to prevent severe infection.^{14,15} Children should receive vaccination against *Streptococcus pneumoniae*, *Haemophilus influenzae*, hepatitis B, and influenza.^{14,15} Folic acid dietary supplements are given daily to most patients with sickle cell anemia because folic acid deficiency may play a role in the causes of crises. In addition, penicillin prophylaxis is used for at least the first 5 years of life. Therapeutic strategies include the use of hydroxyurea (with or without erythropoietin), which induces production of HbF and thus prevents formation of HbS polymers.^{14,15,34} When a crisis occurs, high doses of folic acid, analgesics for pain, hydration, and blood transfusions are used to treat the patient.^{14,15,34} Stem cell transplantation with bone

marrow as the source in a majority of cases from sibling donors carries a 10% mortality rate and a 90% overall survival rate, with a mean follow-up of 54 months.¹⁴ Patients older than 16 years of age are much less likely to have successful grafts.¹⁵ Only about 1% of the patients with sickle cell anemia meet the criteria for stem cell transplantation.³⁵

After the diagnosis of aplastic anemia is established, family human leukocyte antigen (HLA) typing is recommended for patients 50 years of age or younger for possible stem cell transplantation from a histocompatible sibling. Transplantation is curative but is associated with an early mortality rate of 10% in children and young adults and more than 20% in older patients.^{19,20,21} HLA-matched related bone marrow transplantation is curative for 80% to 90% of patients.^{19,20,21} In long-term survivors, however, the development of chronic graft-versus-host disease (GVHD) is common (see Chapter 21).^{20,21} GVHD occurs in about 20% of the patients younger than 20 years of age and in about 40% of those older than 40 years of age.²¹ Immunosuppression with antithymocyte globulin alone or with cyclosporine is the most common therapy for aplastic anemia. Approximately 60% to 80% of patients respond to immunosuppression therapy with 20% to 30% having a complete recovery. Immunosuppressive therapy is associated with fewer early adverse effects and results in partial remission in 60% to 80% of patients but is not curative.¹⁹

DENTAL MANAGEMENT

Medical Considerations

Identification and Risk Assessment. The dentist should obtain a careful history to identify conditions associated with anemia. The assessment should include questions concerning dietary intake, malnutrition, alcohol or drug use, use of nonsteroidal antiinflammatory drugs, menstrual blood loss, pregnancies, hypothyroidism, jaundice, gallstones, splenectomy, bleeding disorders and abnormal Hb, and organ transplantation.^{18,28} Historical information concerning family members also is important for identifying hereditary risk for hemolytic anemias. In children, the history should identify patterns of growth. Women should be queried regarding the onset, nature, and regularity of the menstrual cycle. Women with a history of regular periods but with heavy flow may be anemic and should be referred for appropriate medical evaluation and treatment. Patients who report a change in the pattern, onset, duration, or rate of menstrual flow should be encouraged to seek medical evaluation. Patients who stopped having periods prematurely should be referred for medical evaluation, as should those who have experienced bleeding between regular periods. In addition, in women who are pregnant or who recently experienced childbirth, the history should establish whether the patient had excessive bleeding during pregnancy and whether the patient has other children and when they were

born because the closer together the pregnancies were, the greater is the risk for development of iron deficiency anemia. The mother may lose additional iron during delivery and breastfeeding.

The dentist may identify signs and symptoms of anemia in patients who are seen for dental treatment (Fig. 22.9). A patient with classic signs or symptoms of anemia should be referred directly to a physician and screened by appropriate laboratory tests (see Table 22.2). Screening tests should include complete and differential blood counts, a smear for cell morphologic study, determination of Hb or hematocrit, a Sickledex test (for African American patients), and platelet count.^{18,28} If screening tests are ordered by the dentist and the results of one or more are abnormal, the patient should be referred for medical evaluation and treatment.

Patients with anemia, particularly men, may have a serious underlying disease such as peptic ulcer or carcinoma, for which early detection may be lifesaving. Patients with sickle cell anemia may be at increased risk of complications if the disease is not detected before dental treatment is started. Thus, it is important for the dentist to attempt to identify these patients through history and clinical examination before starting any treatment.

Assessment of the severity of a patient's anemia is important for preventing complications. First and foremost, the dentist should ensure that the patient's underlying condition is stable before proceeding with routine dental treatment. In many cases, anemia is associated with chronic illness; thus, treatment may be provided in the presence of anemia.

Recommendations

To minimize the risk of medical complications, Hb levels should be above 11 g/dL, and the patient should be free



FIG 22.9 Pallor of the hand in anemia is obvious in this patient, especially when compared with the physician's hand on the right. The patient's hemoglobin level was 7 g/dL. The patient's hand also shows that he was a heavy smoker. The cause of the anemia was chronic blood loss from carcinoma of the esophagus. (From Forbes CD, Jackson WF: *Color atlas and text of clinical medicine*, ed 3, Edinburgh, 2003, Mosby.)

from symptoms. Patients who are short of breath and in whom Hb levels are less than 11 g/dL, have an abnormal heart rate, or have an oxygen saturation less than 91% (as determined by pulse oximetry) are considered medically unstable, and routine treatment should be deferred until their health status improves.

Patients with G6PD deficiency exhibit an increased incidence of drug sensitivity with sulfonamides (sulfamethoxazole), aspirin, and chloramphenicol being the prime offenders. Penicillin, streptomycin, and isoniazid also have been linked to hemolysis in these patients.^{7,36} Dental infection may accelerate the rate of hemolysis in patients with this type of anemia.^{17,37} Thus, dental infections should be avoided, and if they occur, they must be managed effectively. The astute clinician will recognize that febrile illness and elevated bilirubin are features of this condition. The drugs listed previously should not be used in these patients.

African Americans with sickle cell anemia can receive routine dental care during noncrisis periods; however, long and complicated procedures should be avoided. Appropriate restorative and preventive dental care are important because oral infection can precipitate a crisis. If infection occurs, it must be treated expeditiously using local and systemic measures, such as incision and drainage, heat, therapeutic doses of appropriate antibiotics, pulpectomy, or extraction. If cellulitis develops, the patient's physician

must be consulted and hospitalization considered.¹⁷ Adequate fluid intake is important for avoiding dehydration. Dental management considerations for patients with sickle cell anemia are summarized in [Box 22.1](#).

Anesthesia. For routine dental care, appointments should be short for patients with sickle cell anemia to minimize stress. The use of a local anesthetic is acceptable (avoid prilocaine and general anesthesia); however, inclusion of small amounts of epinephrine in the local anesthetic is controversial because some authors believe it may impair circulation and cause vascular occlusion.³⁸ The benefits of a vasoconstrictor probably outweigh the risk of local impairment of circulation.³⁸ Thus, the use of a local anesthetic with epinephrine 1:100,000 to attain hemostasis and profound anesthesia is warranted. Stronger concentrations of epinephrine must be avoided. If required, nitrous oxide–oxygen (N₂O–O₂) should be used for short periods, with at least 50% oxygen concentration provided.³⁸

Intravenous sedation must be used with extreme caution in patients who have a history of sickle cell anemia. Barbiturates and narcotics should be avoided because suppression of the respiratory center by these agents leads to hypoxia and acidosis, which may precipitate an acute crisis. Light sedation can be provided with midazolam (Versed) or nalbuphine hydrochloride.^{38,39} Additional oxygen provided by nasal cannula and liberal use of IV fluids during sedation are advised.³⁴ General anesthesia

BOX 22.1 Dental Management Considerations in the Patient With Sickle Cell Anemia

P Patient Evaluation and Risk Assessment (see Box 1.1)		C	
<ul style="list-style-type: none"> Screening tests include white blood cell count with differential, hemoglobin or hematocrit determination, blood smear, and Sickledex test. Confirm with patient's physician that condition is stable. 		Chair position	No issues
Potential Issues and Factors of Concern		Cardiovascular	No issues
		Consultation	Consult with patient's physician before surgical procedures are performed.
		D	
A		Drugs	Avoid barbiturates and strong narcotics; sedation may be obtained with midazolam (Versed). When using nitrous oxide, provide oxygen at greater than 50% with high flow rate and good ventilation.
		Devices	No issues
		E	
B		Equipment	Use pulse oximeter and maintain oxygen saturation above 95%.
		Emergencies	Treat acute infection with incision and drainage if indicated; local heat and high doses of appropriate antibiotics will help avoid a crisis. Dehydration should be avoided. If sickling crisis occurs, hospitalization is indicated.
		F	
Bleeding	No issues	Follow-up	Follow-up consultation with patient's physician is advised.
Breathing	No issues		
Blood pressure	No issues		

is not recommended when the Hb level falls below 10 g/dL.⁴⁰ High doses of salicylates should be avoided because the “acid” effect can precipitate a crisis. Pain control may be attempted with use of acetaminophen and small doses of codeine.^{41,42}

Although there is no evidence supporting their use, prophylactic antibiotics are often recommended for sickle cell anemia when major surgical procedures are performed to prevent wound infection or osteomyelitis.⁴³ Penicillin is the drug of choice in nonallergic patients; however, amoxicillin and clindamycin are also considered acceptable for prophylaxis.⁴³ Intramuscular or IV antibiotics should be considered for use in patients with sickle cell anemia who have an acute dental infection. Dehydration must be avoided during surgery and the postoperative period. Consultation with the patient’s physician is recommended before any surgical procedure. The dentist must establish the patient’s current status, and if blood transfusion is indicated, severe anemia or its complications must be managed effectively before surgery.⁴²

Bleeding. Persons with aplastic anemia are susceptible to infection and bleeding, so clinical recognition of such patients before invasive dental procedures are performed is important. Patients with signs and symptoms of anemia, petechiae, ecchymoses, and gingival bleeding should be referred to a physician for evaluation, diagnosis, and treatment as indicated. The dental management of the patient treated by immunosuppression or bone marrow transplantation is covered in [Chapter 21](#).

Capacity to Tolerate Care. Patients who are short of breath or have Hb levels below 11 g/dL, an abnormal heart rate, or oxygen saturation less than 91% are considered medically unstable, and routine treatment should be deferred until their health status improves. Delays in dental treatment also may be required for patients who have anemia caused by severe underlying conditions.

Treatment Planning Modifications

Treatment planning modifications are directed primarily toward patients who have severe anemia or sickle cell anemia. Elective surgical procedures are best avoided in patients with sickle cell anemia. Routine dental care can be rendered for patients with sickle cell trait and for those in whom the disease is in a noncrisis state. Special emphasis should be placed on oral hygiene procedures to avoid development of dental caries, gingival inflammation, and infection, which can lead to osteomyelitis.^{44,45} Adequate oxygenation should be provided during nitrous oxide inhalation procedures. Pulse oximetry monitoring is prudent during invasive dental treatment of all patients with anemia.

ORAL MANIFESTATIONS

Oral findings in patients with anemia usually relate to the underlying cause of the anemia. The oral mucosa

often appears pale. Patients with nutritional causes of anemia (e.g., vitamin B₁₂ or iron deficiency) may show loss of papillae from the tongue and atrophic changes in the oral mucosa (see [Fig. 22.6](#)). Angular cheilitis and aphthae may be found. Patients also may report a burning or sore tongue. Some patients with iron deficiency anemia develop Plummer-Vinson syndrome ([Fig. 22.10](#)), which is characterized by a sore mouth, dysphagia (resulting from muscular degeneration in the esophagus with esophageal stenosis or “webbing”), and an increased frequency of carcinoma of the oral cavity and pharynx. Patients with this syndrome should be monitored closely for any oral or pharyngeal tissue changes that might be early indicators of carcinoma.^{17,46,47}

Patients with hemolytic anemia (e.g., sickle cell anemia) may show pallor and oral evidence of jaundice caused by hyperbilirubinemia caused by excessive erythrocyte destruction. The trabecular pattern of the bone on dental radiographs may be affected because of hyperplasia of marrow elements in response to increased destruction of RBCs. Therefore, dental radiographs may show enlarged bone marrow (medullary) spaces associated with bone marrow hyperplasia, increased widening and decreased numbers of trabeculations, and generalized osteoporosis (thinning



FIG 22.10 Feature of Plummer-Vinson syndrome. Barium contrast radiograph demonstrates esophageal webbing. (From Bricker SL, Langlais RP, Miller CS: *Oral diagnosis, oral medicine, and treatment planning*, ed 2, Hamilton, Ontario, 2002, BC Decker. Courtesy of Dr. Thomas J. Vaughan.)



FIG 22.11 Periapical radiograph of the mandible in a patient with sickle cell anemia. Note the prominent horizontal trabeculations and the dense lamina dura.

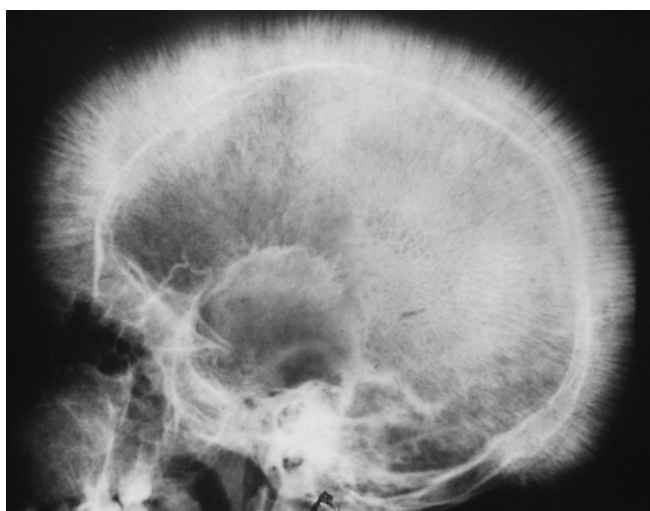

FIG 22.12 Skull film in a patient with hemolytic anemia shows new bone formation on the outer table, producing perpendicular radiations or "hair on end" appearance. (From Kumar V, Abbas A, Fausto N: *Robbins & Cotran pathologic basis of disease*, ed 8, Philadelphia, 2010, Saunders. Courtesy of Dr. Jack Reynolds, Department of Radiology, University of Texas Southwestern Medical School, Dallas, TX.)

of the inferior border of the mandible). Because of compensatory marrow expansion, the bone appears more radiolucent, with prominent lamellar striations.^{17,47} Specifically, the trabeculae between teeth may appear as horizontal rows or in a "stepladder" configuration (Fig. 22.11). This can also manifest as frontal bossing or "hair-on-end" appearance in the cortical regions of a skull film (Fig. 22.12). Vasoocclusive events can promote asymptomatic pulpal necrosis, osteomyelitis, ischemic necrosis within the mandible, and peripheral neuropathy. Patients with sickle cell anemia often have delayed eruption of teeth and



FIG 22.13 Aplastic anemia. Diffuse gingival hyperplasia with sulcal hemorrhage. (From Neville BW, Damm DD, Allen CM, et al, editors: *Oral and maxillofacial pathology*, ed 3, St. Louis, 2009, Saunders.)

dental hypoplasia.^{17,35} Cone-beam computed tomography has been advocated for more detailed analysis of maxillofacial bones in patients with sickle cell anemia.^{6,13,48}

The oral findings associated with aplastic anemia include petechiae, ecchymoses, mucosal pallor, ulceration (infection), gingival bleeding, and gingival hyperplasia.³⁵ Fig. 22.13 shows an example of diffuse gingival hyperplasia with sulcal bleeding. Another oral finding of aplastic anemia is necrotizing gingivostomatitis.⁴⁹ Chapter 21 describes oral complications of immunosuppression and bone marrow transplantation and their management.

REFERENCES

1. Cavusoglu E. Usefulness of anemia in men as an independent predictor of two-year cardiovascular outcome in patients presenting with acute coronary syndrome. *Am J Cardiol.* 2006;98:580-584.
2. Penninx BW. Anemia in old age is associated with increased mortality and hospitalization. *J Gerontol A Biol Sci Med Sci.* 2006;61(5):474-479.
3. Swaak A. Anemia of chronic disease in patients with rheumatoid arthritis: aspects of prevalence, outcome, diagnosis, and the effect of treatment on disease activity. *J Rheumatol.* 2006;33:1467-1468.
4. Walker AM. Anemia as a predictor of cardiovascular events in patients with elevated serum creatinine. *J Am Soc Nephrol.* 2006;17:2293-2298.
5. Giardina PJ, Forget BG. Thalassemia syndromes. In: Hoffman R, et al, eds. *Hematology: Basic Principles and Practice*. 5th ed. Philadelphia: Churchill Livingstone; 2009:535-564.
6. Babior BM. Folate, cobalamin and megaloblastic anemias. In: Lichtman MA, et al, eds. *Williams Hematology*. New York: McGraw-Hill; 2006.
7. Golan DE. Hemolytic anemias: red cell membrane and metabolic defects. In: Goldman L, Ausiello D, eds. *Cecil Medicine*. 23rd ed. Philadelphia: Saunders; 2008:1203-1211.

8. Gallagher PG, Jarolim P. Red blood cell membrane disorders. In: Hoffman R, et al, eds. *Hematology: Basic Principles and Practice*. 5th ed. Philadelphia: Churchill Livingstone; 2009:623-643.
9. Castro-Malaspina H, O'Reilly RJ. Aplastic anemia and related disorders. In: Goldman L, Ausiello D, eds. *Cecil Medicine*. 23rd ed. Philadelphia: Saunders; 2008:1241-1247.
10. Cappellini MD, Motta I. Anemia in clinical practice—definition and classification: Does hemoglobin change with aging? *Semin Hematol*. 2015;52:261-269.
11. Silver BJ. Anemia. In: Carey WD, et al, eds. *Current Clinical Medicine 2009, Cleveland Clinic*. Philadelphia: Saunders; 2009:615-620.
12. Frith-Terhune AL. Iron deficiency anemia: higher prevalence in Mexican American than in non-Hispanic white females in the Third National Health and Nutrition Examination Survey, 1988-1994. *Am J Clin Nutr*. 2000;72:963-968.
13. Ginder GD. Microcytic and hypochromic anemias. In: Goldman L, Ausiello D, eds. *Cecil Medicine*. 23rd ed. Philadelphia: Saunders; 2008:1187-1193.
14. Sauntharajah Y, Vichinsky EP. Sickle cell disease. Clinical features and management. In: Hoffman R, et al, eds. *Hematology: Basic Principles and Practice*. 5th ed. Philadelphia: Churchill Livingstone; 2009:577-602.
15. Steinberg MH. Sickle cell disease and associated hemoglobinopathies. In: Goldman L, Ausiello D, eds. *Cecil Medicine*. 23rd ed. Philadelphia: Saunders; 2008:1217-1225.
16. Bsoul SA. Sickle cell disease. *Quintessence Int*. 2003;34:76-77.
17. DeRossi SS, Garfunkel A, Greenberg MS. Hematologic diseases. In: Lynch MA, ed. *Burket's Oral Medicine: Diagnosis and Treatment*. 10th ed. Hamilton, Ontario: BCDecker; 2003.
18. Huber MA, Sankar V. Hematologic diseases. In: Glick M, ed. *Burket's Oral Medicine*. 12th ed. Shelton: PMPH; 2015:435-462.
19. Castro-Malaspina H, O'Reilly RJ. Aplastic anemia and related disorders. In: Goldman L, Ausiello D, eds. *Cecil Medicine*. 23rd ed. Philadelphia: Saunders; 2008:1241-1247.
20. Young NS. Aplastic anemia, myelodysplasia and related bone marrow failure. In: Fauci AS, et al, eds. *Harrison's Principles of Internal Medicine*. 17th ed. New York: McGraw-Hill; 2008:663-670.
21. Young NS, Maciejewski JP. Aplastic anemia. In: Hoffman R, et al, eds. *Hematology: Basic Principles and Practice*. 5th ed. Philadelphia: Churchill Livingstone; 2009:359-384.
22. Suresh L, Radfar L. Pregnancy and lactation. *Oral Surg Oral Med Oral Pathol Oral Radiol Endod*. 2004;97:672-682.
23. Antony AC. Megaloblastic anemias. In: Hoffman R, et al, eds. *Hematology: Basic Principles and Practice*. 5th ed. Philadelphia: Churchill Livingstone; 2009:491-524.
24. Bizzaro N, Antico A. Diagnosis and classification of pernicious anemia. *Autoimmun Rev*. 2014;13:565-568.
25. Zuckerman KS. Approach to the anemias. In: Goldman L, Ausiello D, eds. *Cecil Medicine*. 23rd ed. Philadelphia: Saunders; 2008:1179-1188.
26. Brittenham GM. Disorders of iron metabolism: iron deficiency and iron overload. In: Hoffman R, et al, eds. *Hematology: Basic Principles and Practice*. 5th ed. Philadelphia: Churchill Livingstone; 2009:453-468.
27. Desai B, Sollecito TP. Hematological disease. In: Patton LL, Glick M, eds. *The ADA Practical Guide to Patients With Medical Conditions*. 2nd ed. Hoboken: John Wiley and Sons, Inc.; 2015:153-182.
28. Forbes CD, Jackson WF. *Color Atlas and Text of Clinical Medicine*. 3rd ed. St. Louis: Mosby; 2003.
29. Marks PW, Gladere B. Approach to anemia in the adult and child. In: Hoffman R, et al, eds. *Hematology: Basic Principles and Practice*. 5th ed. Philadelphia: Churchill Livingstone; 2009:439-446.
30. Johnson-Wimbley TD, Graham DY. Diagnosis and management of iron deficiency anemia in the 21st century. *Therap Adv Gastroenterol*. 2011;4:177-184.
31. Wilson A. Prevalence and outcomes of anemia in rheumatoid arthritis: a systematic review of the literature. *Am J Med*. 2004;Suppl 7A:50S-57S.
32. Elghetany MT, Banki K. Erythrocytic disorders. In: McPherson RA, Pincus MR, eds. *Henry's Clinical Diagnosis and Management by Laboratory Methods*. 21st ed. Philadelphia: Saunders; 2007.
33. Centers for Disease Control and Prevention. Recommendation to prevent and control iron deficiency in the United States. *MMWR Recomm Rep*. 1998;47:1-29.
34. Davies SC, Gilmore A. The role of hydroxyurea in the management of sickle cell disease. *Blood Rev*. 2003;17:99-109.
35. Neville BW. Hematologic disorders. In: Neville BW, et al, eds. *Oral and Maxillofacial Pathology*. 3rd ed. St. Louis: Saunders; 2009:571-612.
36. Gregg XT, Prchal JT. Red blood cell enzymopathies. In: Hoffman R, et al, eds. *Hematology: Basic Principles and Practice*. 5th ed. Philadelphia: Churchill Livingstone; 2009:611-622.
37. Micromedex: Drug Information for the Health Care Professional. Taunton, Mass: Thomson Micromedex, 2006.
38. Lockhart PB. *Dental Care of the Medically Complex Patient*. 5th ed. St. Louis: Wright Elsevier; 2004.
39. Ruwende C, Hill A. Glucose-6 phosphate dehydrogenase deficiency and malaria. *J Mol Med*. 1998;76:581-588.
40. Derossi SS, Raghavendra S. Anemia. *Oral Surg Oral Med Oral Pathol Oral Radiol Endod*. 2003;95:131-141.
41. Sansevere JJ, Milles M. Management of the oral and maxillofacial surgery patient with sickle cell disease and related hemoglobinopathies. *J Oral Maxillofac Surg*. 1993;51:912-916.
42. Smith HB, McDonald DK, Miller RI. Dental management of patients with sickle cell disorders. *J Am Dent Assoc*. 1987;114:85-87.
43. Stanley AC, Christian JM. Sickle cell disease and perioperative considerations: review and retrospective report. *J Oral Maxillofac Surg*. 2013;71:1027-1033.
44. Acharya S. Oral and dental considerations in management of sickle cell anemia. *Int J Clin Pediatr Dent*. 2015;8:141-144.

45. Javed F, Correa FO, Nooh N, et al. Orofacial manifestations in patients with sickle cell disease. *Am J Med Sci.* 2013;345:234-237.
46. Neville BW, et al. *Oral and Maxillofacial Pathology.* 2nd ed. Philadelphia: WB Saunders; 2002.
47. Shafer WG, Hine MK, Levy BM. *A Textbook of Oral Pathology.* 4th ed. Philadelphia: WB Saunders; 1983.
48. Avsever IH, Orhan K, Tuncer O, et al. Evaluation of mandibular bone structure in sickle cell anaemia patients. *Gulhane Med J.* 2015;57:11-15.
49. Tewari S, et al. Necrotizing stomatitis: a possible periodontal manifestation of deferiprone-induced agranulocytosis. *Oral Surg Oral Med Oral Pathol Oral Radiol Endod.* 2009;108(4):e13-e19.

Disorders of White Blood Cells

DEFINITION

Disorders of white blood cells (WBCs) in dental patients can substantially influence clinical decision making as well as the delivery of care because WBCs constitute the primary defense against microbial infections and are critical for mounting an immune response (Box 23.1). Defects in WBCs can manifest as delayed healing, infection, or mucosal ulceration and, in some cases, may be fatal. To ensure the health of the patient, the dentist should be able to identify possible WBC abnormalities through history, clinical examination, and screening laboratory tests and should provide prompt referral to a physician for further evaluation and management before invasive dental procedures are performed. Patients with known life-threatening disorders who are under medical care should not receive dental care until after the dentist has consulted with the patient's physician.

Three groups of WBCs are found in the peripheral circulation: granulocytes, lymphocytes, and monocytes. Of the granulocyte population, 90% is composed of neutrophils; the remainder consists of eosinophils and basophils. Circulating lymphocytes are of three types: T lymphocytes (thymus mediated), B lymphocytes (bursa derived), and natural killer (NK) cells. Lymphocytes are subdivided by the surface markers they exhibit and by the cytokines they produce.¹

The primary function of neutrophils is to defend the body against certain infectious agents (primarily bacteria) through phagocytosis and enzymatic destruction. Eosinophils and basophils are involved in inflammatory allergic reactions and mediate these reactions through release of their cytoplasmic granules. Eosinophils also combat infection by parasites. Whereas T lymphocytes (T cells) are involved with the delayed, or cellular, immune reaction, B lymphocytes (B cells) play an important role in the immediate, or humoral, immune system involving the production of plasma cells and immunoglobulins (IgA, IgD, IgE, IgG, and IgM). Monocytes have diverse functions that include phagocytosis; intracellular killing (especially of mycobacteria, fungi, and protozoa); and mediating of the immune and inflammatory response through the production of more than 100 substances, such as cytokines and growth factors that increase the

activity of lymphocytes. In addition, monocytes serve as antigen-presenting cells and migrate into tissues. In tissue, these antigen-presenting cells are known as dendritic cells (in lymph nodes) or Langerhans cells (in skin and mucosa). Monocytes in tissue that phagocytose microbes are known as macrophages.^{1,2}

Most WBCs are produced primarily in the bone marrow (granulocytes and monocytes), and these cells form several "pools" in the marrow: (1) the mitotic pool, which consists of immature precursor cells; (2) a maturing pool, which consists of cells undergoing maturation; and (3) a storage pool of functional cells, which can be released as needed.

White blood cells released by the bone marrow that circulate in the peripheral blood account for only 5% of the total WBC mass and form two pools of cells: (1) marginal and (2) circulating. Cells in the marginal pool adhere to vessel walls and are readily available. When infection threatens the body, the storage and marginal pools can be recruited to help fight the invading organisms.

Growth-promoting substances called *colony-stimulating factors* (CSFs) are responsible for the growth of committed granulocyte–monocyte stem cells. The major function of CSFs is to amplify leukopoiesis rather than recruit new stem cells into the granulocyte–monocyte differentiation pathway. Thus, through the local release of CSFs, the bone marrow can increase the production of granulocytes and monocytes. This process occurs in response to infection.³

Lymphocytes localize primarily in three regions: lymph nodes, the spleen, and the mucosa-associated lymphoid tissue (MALT) lining the respiratory and gastrointestinal tracts. At these sites, microbial antigens are trapped and presented to B or T lymphocytes (cells). Antigens bind B cells through cell surface immunoglobulins, whereupon B cells are activated, proliferate, and produce large amounts of immunoglobulin to aid in opsonization. Antigens are presented to CD4+ (helper) T cells by major histocompatibility complex (MHC) class I molecules and to CD8+ T cells by MHC class II molecules. CD4+ T cells activate B cells and macrophages by producing cytokines and through direct contact. CD8+ T cells kill virus-infected cells.

BOX 23.1 Classification and Features of White Blood Cell (WBC) Dyscrasias

Leukocytosis: increased number of circulating WBCs

Leukopenia: decreased number of circulating WBCs

Myeloproliferative disorders

1. Acute myeloid leukemia: immature neoplastic malignancy of myeloid cells
2. Chronic myeloid leukemia: mature neoplastic malignancy of myeloid cells

Lymphoproliferative disorders

1. Acute lymphoblastic leukemia: immature neoplastic malignancy of lymphoid cells
2. Chronic lymphocytic leukemia: mature neoplastic malignancy of lymphoid cells
3. Lymphomas
 - a. Hodgkin lymphoma: malignant growth of B lymphocytes, primarily in lymph nodes
 - b. Non-Hodgkin lymphoma: B- or T-cell malignant neoplasms, many types and locations; most are of B-cell lineage
 - (1) Burkitt lymphoma: non-Hodgkin B-cell lymphoma involving bone and lymph nodes
4. Multiple myeloma: overproduction of malignant plasma cells involving bone

COMPLICATIONS: Shortness of breath caused by anemia and fatigue and bone pain, malaise, pallor, dyspnea, fever; recurrent infections; oral ulcerations; fever; poor healing; infection; bleeding (hemorrhage, petechiae, ecchymoses); enlargement of tonsils, lymph nodes, spleen, and gingiva; skin lesions (leukemia cutis, granulocytic sarcomas, chloromas); central nervous system (CNS) infiltration of leukemic cells; organ failure (liver, kidney); amyloid deposition in oral mucosa; and death.

LEUKOCYTOSIS AND LEUKOPENIA

The number of circulating WBCs normally ranges from 4400 to 11,000/ μL in adults.⁴ The differential WBC count is an estimation of the percentage of each cell type per microliter of blood. A normal differential count consists of neutrophils, 50% to 60%; lymphocytes, 20% to 34%; monocytes, 3% to 7%; eosinophils, 1% to 3%; and basophils, less than 1%. The term *leukocytosis* is defined as an increase in the number of circulating WBCs (lymphocytes or granulocytes) to greater than 11,000/ μL , and leukopenia as a reduction in the number of circulating WBCs (usually to <4400/ μL).

Many causes of leukocytosis are known. Exercise, pregnancy, and emotional stress can lead to increased numbers of WBCs in the peripheral circulation. Leukocytosis resulting from these causes is called *physiologic leukocytosis*. Pathologic leukocytosis can be caused by infection, neoplasia, or necrosis. Pyogenic infections induce a type of leukocytosis that is characterized by an increased number of neutrophils. If excessive numbers of immature neutrophils (bands or stab cells) are released into the

circulation in response to a bacterial infection, a “shift to the left” is said to have occurred. Tuberculosis, syphilis, and viral infections produce a type of leukocytosis that is characterized by increased numbers of lymphocytes. Protozoal infections often produce a type of leukocytosis that increases the numbers of monocytes. Allergies and parasitic infections caused by certain helminths increase the numbers of circulating eosinophils. Cellular necrosis increases the numbers of circulating neutrophils. Leukemia (cancer of the WBCs) is characterized by a substantial increase in the numbers of circulating immature leukocytes. Carcinoma of glandular tissues may cause an increase in the number of circulating neutrophils. Acute bleeding also can result in leukocytosis.^{2,4}

Many causes of deficient numbers of leukocytes (<4400/ μL) in the blood are evident. *Leukopenia* may occur in the early phase of leukemia and lymphoma as a result of bone marrow replacement through excessive proliferation of WBCs. *Leukopenia* also occurs during agranulocytosis (reduction of granulocytes) and pancytopenia (decreased WBCs and red blood cell [RBCs]) that result from toxic effects of drugs and chemicals. *Leukopenia* is a common complication that results from the use of chemotherapeutic (anticancer) drugs.^{2,4}

Cyclic Neutropenia

An important form of leukopenia involving the cyclic depression of circulating neutrophils is a disorder called *cyclic neutropenia*. It is associated with mutations located near the junction of exons 4 and 5 of the neutrophil elastase gene (*ELA2*).² The estimated frequency of cyclic neutropenia is about 1 in 1 million.⁵ In this condition, patients have a periodic decrease (at least a 40% drop) in the number of neutrophils (about every 21–28 days). During the period in which few circulating neutrophils are present, the patient is susceptible to infection and oral manifestations (see under [Oral Complications and Manifestations](#)).^{2,6} Up to 10% of patients die from pneumonia, cellulitis, or peritonitis.²

Patients with *leukocytosis* or *leukopenia* may have bone marrow abnormalities that can cause thrombocytopenia. Examination of the patient’s bone marrow aspirate is important for making the final diagnosis. Infectious diseases that can cause *leukocytosis* and *leukopenia* are discussed in [Chapters 7, 13, and 18](#).

LEUKEMIA AND LYMPHOMA

The remainder of this chapter focuses on leukemia and malignancies of lymphoid cells (lymphoma and multiple myeloma [MM]). These patients become gravely ill if they are not properly identified and do not receive appropriate medical care. In addition, patients are usually immunosuppressed as a result of the disease itself or because of the treatment used to control it. Hence, they are prone to develop serious infection and often bleed easily because of thrombocytopenia.⁷⁻¹¹

About every 3 minutes, a person in the United States is diagnosed with a blood cancer. An estimated combined total of 162,020 people in the United States were expected to be diagnosed with leukemia, lymphoma, or myeloma in 2015. New cases of leukemia, lymphoma, and myeloma were expected to account for 9.8% of the estimated 1,658,370 new cases diagnosed in the United States in 2015. An estimated 1,185,053 people in the United States are either living with or are in remission from leukemia, lymphoma, or myeloma. The most recent survival data available may not fully represent the outcomes of all current therapies and as a result may underestimate survival to a small degree. Approximately every 9 minutes, someone in the United States dies from a blood cancer, accounting for 160 people each day or more than 6 people every hour. Leukemia, lymphoma, and myeloma were expected to cause the deaths of an estimated 56,630 people in the United States in 2015. These diseases were expected to account for 9.6% of the deaths (589,430) from cancer in 2015.^{12,13} A dental practice that manages 2000 patients is predicted to have 1 to 3 patients who have or develop leukemia or a malignancy of lymphoid cells.

Leukemia

Leukemia is cancer of the WBCs that affects the bone marrow and circulating blood. It involves exponential proliferation of a clonal myeloid or lymphoid cell and occurs in both acute and chronic forms. Acute leukemia is a rapidly progressive disease that results from accumulation of immature, nonfunctional WBCs in the marrow and blood. Chronic leukemias have a slower onset, which allows production of larger numbers of more mature (terminally differentiated), functional cells. This section focuses on four types of leukemia: (1) acute myelogenous leukemia (AML), (2) acute lymphocytic leukemia (ALL), (3) chronic myelogenous leukemia (CML), and (4) chronic lymphocytic leukemia (CLL).⁷⁻¹¹

The cause of leukemia remains unknown. Increased risk is associated with large doses of ionizing radiation, certain chemicals (benzene), and infection with specific viruses (e.g., Epstein-Barr virus [EBV], human lymphotropic virus [HTLV]-1). Cigarette smoking and exposure to electromagnetic fields also have been proposed to be causative.¹⁴⁻¹⁷

Leukemia

In 2016, 60,140 people were expected to be diagnosed with leukemia. There are an estimated 354,422 people living with or in remission from leukemia in the United States. The overall 5-year relative survival rate for leukemia has more than quadrupled since 1960. From 2005 to 2011, the 5-year relative survival rates were 63.2% for CML, 84.8% for CLL, 26% for AML, and 70% for ALL. In 2016, 24,400 people were expected to die from leukemia (14,130 males and 10,270 females). From 2008 to 2012, leukemia was the fifth most common cause of cancer deaths in men

and the sixth most common in women in the United States.^{12,13,18}

ACUTE MYELOGENOUS LEUKEMIA

DEFINITION

Acute myelogenous leukemia is a neoplasm of myeloid (immature) WBCs, which demonstrate uncontrolled proliferation in the bone marrow space and subsequently appear in the peripheral blood.

Epidemiology

Acute myelogenous leukemia occurs in about 19,950 persons in the United States annually and accounts for 28.6% of all leukemias.¹⁹ AML is a disease of adults.¹⁶ The incidence increases with age and rises rapidly after the age of 50 years,¹⁶ reaching 22 per 100,000 by age 80 years. The mean age of persons with AML in the United States is 65 years.¹⁶

Etiology

Acute myelogenous leukemia arises de novo in younger adults or secondarily in older adults as a consequence of myelodysplasia. *Myelodysplastic syndromes* describe a diverse group of clonal disorders of hematopoietic stem or progenitor cells resulting in abnormal cellular differentiation that evolves into AML in 30% of cases.²⁰ Environmental factors such as tobacco smoke, benzene-containing products, chemotherapies for cancer, and radiation exposure appear to be risk factors for AML.¹⁶ It is estimated that 10% to 20% of all cases of AML are now therapy related.¹⁶ Genetic factors (e.g., translocation and rearrangement of chromosomes) may cause cytogenetic abnormalities that affect transcriptional cascades of myeloid precursor cells and uncontrolled proliferation of these cells. Certain genetic disorders increase the risk for AML, including Down syndrome, Klinefelter syndrome, Fanconi anemia, and von Recklinghausen disease.¹⁶

Pathophysiology and Complications

Acute myelogenous leukemia has a sudden onset and leads to death in 1 to 3 months if left untreated.²¹ It involves increased numbers of immature myeloid WBCs in the bone marrow space and peripheral circulation (Fig. 23.1). As a result, patients are susceptible to excessive bleeding, anemia, poor healing, and infection after surgical procedures.²¹ Hemorrhage and infection, frequent complications of chemotherapy, are the chief causes of death.

CLINICAL PRESENTATION

Signs and Symptoms

Acute myelogenous leukemia produces a leukemic infiltration of marrow and organs that causes cytopenia and diverse non-specific signs and symptoms, including fatigue, easy bruising, and bone pain. Many patients complain

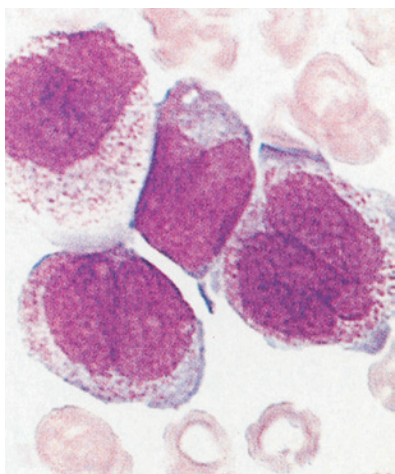

FIG 23.1 Acute myeloid leukemia. Peripheral blood smear shows many myeloid cells with large nuclei and azurophilic granules. (From Hoffbrand AV, Pettit JE: *Color atlas of clinical hematology*, ed 4, London, 2010, Mosby. Courtesy of Prof. J.M. Chessells.)

of flu-like symptoms for 4 to 6 weeks before the diagnosis. Anemia and thrombocytopenia usually manifest as malaise, pallor, dyspnea on exertion, and bleeding and small hemorrhage (petechiae, ecchymoses) in the skin and mucous membranes (Fig. 23.2, A).^{15,16} Because of granulocytopenia, at least one third of patients have recurrent infections (nonhealing wounds), oral ulcerations, and fever. Enlargement of the tonsils, lymph nodes, spleen, and gingiva (Fig. 23.2, B) occurs as a result of leukemic infiltration of these tissues.¹⁶ Infiltration of the CNS occurs in about 35% of the cases of AML with increased eosinophils (the M4Eo variant).¹⁶ Most of these patients are asymptomatic, but some present with meningeal signs and symptoms and symptoms associated with increased intracranial pressure.¹⁶ Skin lesions, consisting of collections of leukemic cells termed *leukemia cutis*, *granulocytic sarcomas*, and *chloromas*, may occur.¹⁵

Laboratory Findings

The diagnosis of leukemia is made through examination of peripheral blood and bone marrow stained with Wright-Giemsa. Cytochemical staining, immunophenotyping, and cytogenetic analyses are used to characterize the type and subtype, to allow for specific treatment approaches, and to detect residual disease after therapy is provided. Granulocytopenia and thrombocytopenia are common.

The diagnosis of AML is made when myeloblasts are found in the bone marrow or peripheral blood at a rate of at least 20%. Myeloblasts stain positive for myeloperoxidase and are immunotype positive for several of the following markers: CD13, CD33, CD34, CD65, and CD117.²² The French-American-British (FAB) classification categorizes AML into eight subtypes (Table 23.1). The World Health Organization (WHO) classification describes several subtypes that differ in terms of genetic abnormalities, evolution, and response to therapy.^{15,16}



FIG 23.2 A, Acute myeloid leukemia presenting as bleeding and ecchymosis of the tongue in a 14-year-old patient. **B**, Gingival leukemia infiltrate in a patient with acute myeloid leukemia.

ACUTE LYMPHOID LEUKEMIA

DEFINITION

Acute lymphocytic leukemia is the result of uncontrolled monoclonal proliferation of immature lymphoid cells in the bone marrow and peripheral blood. These neoplastic cells may also expand in the lymph nodes, liver, spleen, or CNS.

EPIDEMIOLOGY

In 2016, 6590 cases of ALL were estimated to occur in the United States.¹⁹ ALL occurs at an incidence of 1.7 in 100,000 and typically occurs in children.²³ It accounts for about 25% of all neoplasms in children and 80% of leukemias in children.²⁴ A remarkable peak of incidence occurs in children who are 2 to 3 years old, and 57% of cases are reported in persons younger than age 20 years (median age at diagnosis, 15 years).²⁵ Boys are affected

TABLE 23.1 Classification of Acute Leukemias and Associated Clinical, Cytologic, and Immunologic Abnormalities*

FAB Subtype	Common Name (% of Cases)	Cell Surface Markers	Chromosomal Abnormality(ies)
M0	Acute undifferentiated leukemia (3%–5%)	Anti-CD13, CD14, CD33, CD34	Various
M1	Acute myeloblastic leukemia with minimal differentiation (15%–20%)	Anti-CD13, CD33, CD33, CD34	Various
M2	Acute myeloid leukemia with differentiation (25%–30%)	Anti-CD14, CD15, CD33, CD34	Various, including t(8;21)
M3	Acute promyelocytic leukemia (10%–15%)	Anti-CD13, CD15, CD33, CD65	t(15;17)
M4	Acute myelomonocytic leukemia (20%–30%)	Anti-CD13, CD15, CD33, CD34	Various, including inv/del (16)
M5a and M5b Type a: 80% monoblasts Type b: >20% promonocytes	Acute monocytic leukemia (5a: 2%–9%) (5b: 2%–5%)	HLA-DR, anti-CD13, CD15, CD33, CD34	Various, including abnormalities of 11q23
M6	Acute erythroleukemia (3%–5%)	Antiglycopherin antispectrin	
M7	Acute megakaryocytic leukemia (3%–5%)	CD41, CD61	
L1, childhood variant	Acute lymphoid leukemia; small, uniform blasts, nucleoli indistinct	≈65% react with anti-CD10; 20% with T-cell phenotype: anti-CD1, -2, -3, -5, or -7	t(9;22), t(4;11), and t(1;9)
L2, adult variant	Acute lymphoid leukemia; larger, more irregular nucleoli present		
L3, Burkitt-like	Acute lymphoid leukemia; large, with strong basophilic cytoplasm and vacuoles	Anti-CD19, -20	t(8;14)

*Clinical signs of leukemia include pallor, lymphadenopathy, petechiae, ecchymoses, gingival enlargement, oral ulcerations, loose teeth, pulpal abscess, enlarged tonsils, gingival bleeding, and recurrent infections.

†The World Health Organization classifies acute myelogenous leukemia into four major categories: acute myeloid leukemia with recurrent genetic abnormalities (four subtypes), acute myeloid leukemia with multilineage dysplasia (two subtypes), acute myeloid leukemia and myelodysplastic syndromes (two subtypes), acute myeloid leukemia, and not otherwise categorized (11 subtypes).

Adapted from Appelbaum FR: Acute myeloid leukemia in adults. In Goldman L, Ausiello D, editors: *Cecil medicine*, ed 23, Philadelphia, 2008, Saunders, pp 1390-1396.

slightly more often than girls. About 20% of cases occur after age 55 years.²⁵

Etiology

Although environmental, infectious, and genetic factors are considered likely causes of the disease, causal links for ALL have not been established. The disease is 18- to 20-fold more common in patients with Down syndrome (trisomy 21). Cytogenetic studies frequently display the Philadelphia chromosome [t(9;22)], a shortened chromosome 22, as a result of translocation of genes between the long arms of chromosomes 9 and 22. About 5% of children and 25% of adults with ALL have cytogenetics showing the Philadelphia chromosome. Patients with the Philadelphia chromosome have slightly lower complete remission rates and greatly reduced remission durations. Other chromosomal anomalies are also common.^{14,23}

Pathophysiology and Complications

Similar to AML, ALL results in suppression of normal hematopoiesis, leaving patients susceptible to excessive bleeding, anemia, poor healing, and infection after surgical procedures have been performed.^{14,23} Treatment of children results in remission rates that exceed 90% and cure rates

above 70%. In adults, long-term survival from ALL occurs at rates of about 70%.^{14,23}

CLINICAL PRESENTATION

Signs and Symptoms

The clinical presentation of ALL can be acute or insidious. Presenting signs and symptoms relate to anemia, thrombocytopenia, fever, and neutropenia. Frequently, bone and joint pain have effects on walking. In one large study, one third of the patients presented with infection or fever; one third presented with hemorrhagic episodes; and more than half of the patients with enlargement of the liver, spleen, and lymph nodes.²³ A higher propensity toward CNS disease occurs with ALL compared with AML. Patients may present with cranial nerve deficiencies.²³

Laboratory Findings

Acute lymphocytic leukemia is diagnosed when massive replacement of the bone marrow space with leukemic blast cells is observed. Fig. 23.3 shows a peripheral blood smear of ALL. A correspondingly high number of lymphoblasts are detected in the peripheral blood smear, and levels of hemoglobin, hematocrit, and platelets are

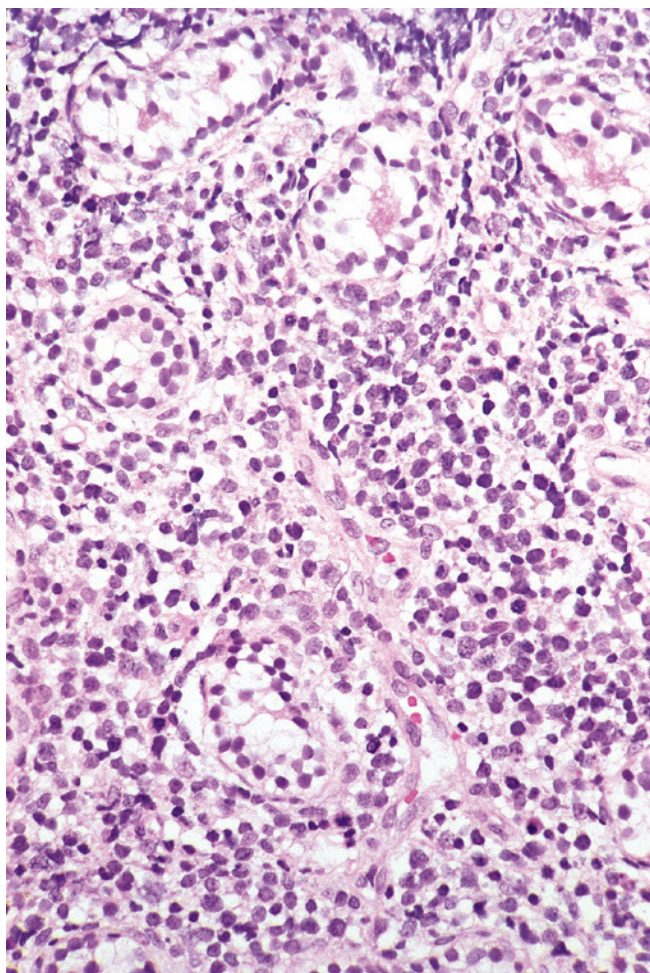

FIG 23.3 Peripheral blood smear of acute lymphoblastic leukemia. (From Hoffbrand AV, Pettit JE: *Color atlas of clinical hematology*, ed 4, London, 2010, Mosby.)

depressed, reflecting large replacement of marrow by lymphoblasts. Immunotyping and flow cytometry is the preferred method of lineage assignment and assessment of cell maturation. Detection of a nuclear enzyme, terminal deoxynucleotidyl transferase (Tdt), along with (B-cell) antigen (CD10, originally designated CALLA) and CD19, CD22, and HLA-DR, allows histologic classification of ALL.^{14,23}

According to the French-American-British Cooperative Group, three distinct subtypes are based on type and size of neoplastic lymphocytes: L1 (cells small and homogeneous), L2 (cells pleomorphic and often large), and L3 (cells homogeneous and of medium size with dispersed chromatin).^{14,23}

MEDICAL MANAGEMENT OF ACUTE LEUKEMIA

The ability to cure a patient of acute leukemia is related to tumor burden and the rapid elimination of malignant WBCs. Normal bone marrow consists of 0.3% to 5% blast cells. Patients with acute leukemia have 100-fold

(≈ 1 trillion) more blast cells. After effective chemotherapy has been given, the number of blast cells is reduced from trillions to billions, leukemic cells can no longer be detected, and the patient is said to be in remission. With a 5-day generation time for the remaining undetectable leukemic cell mass, 10 doublings in 50 days could restore the leukemic cell mass to 1 trillion cells, and the patient would again show signs and symptoms of leukemia. This would constitute a short remission with relapse.²⁶

Chemotherapy for acute leukemia consists of three phases. The purpose of the first phase (induction) is to aggressively induce a state of remission by killing tumor cells with cytotoxic agents. Agents used to treat the acute leukemias are shown in Table 23.2. The second phase (consolidation or intensification) focuses on consolidating the kill of remaining leukemic cells. During the third phase (complete remission), maintenance therapy is provided to prevent expansion of any remaining leukemic cell mass. The criteria for complete remission include the following: platelet count higher than 100,000/ μL , neutrophil count greater than 1000/ μL , and bone marrow specimen with less than 5% blasts.²⁷ During induction and consolidation, myeloid growth factors (granulocyte colony-stimulating factor [G-CSF] and granulocyte-monocyte colony-stimulating factor [GM-CSF]) are administered at some institutes to shorten the duration of neutropenia and reduce the incidence of severe infection.

Patients are cured of leukemia when no leukemic cells remain. Long-term survival occurs when the leukemic cell mass is greatly reduced and is kept from increasing over a long period. In general, when a patient relapses, a second remission is more difficult to induce, and if it occurs, it will be of a shorter duration. Bone marrow transplantation (BMT) generally is reserved for patients younger than 45 years of age and for children and young adults who relapse when a suitable sibling match is available (allogeneic).^{14,23} The marrow transplant or, more recently, the peripheral blood stem cell transplant procedure is preceded by high-dose chemotherapy (including busulfan) and radiation therapy.

Treatment of patients with AML is shown in Table 23.3. In 1966, the median survival time of adults with AML was 40 days.¹⁵ Today, patients younger than 60 years have complete remission rates of 70% to 80% after induction therapy, but the overall survival rate is only 50% for those who go into complete remission and 26.6% overall.¹⁵ The prognosis of AML in adults who are 60 years or older is poorer. The remission rate for older patients is 52% for patients 60 to 69 years and only 26% for patients 70 years or older with long-term survival rates of only 5% to 10% (Table 23.4).^{14,15}

Treatment for ALL is shown in Table 23.3. The prognosis for children with ALL is very good, with cure now being attained in more than 70% of cases. The prognosis is worse in persons older than 30 years of age and with a blast count greater than 50,000/ μL , with mature

TABLE 23.2 Classes of Drugs Used to Treat Leukemia

Drug Class	Chemotherapeutic Agents	Mechanism of Action
Alkylating agents	Busulfan, carmustine, cyclophosphamide, dacarbazine, lomustine nitrogen mustard <i>derivative</i> : chlorambucil	Produce alkyl radicals, causing cross-linking of DNA and inhibition of DNA synthesis in rapidly replicating tumor cells
Antibiotics	Bleomycin, daunorubicin, doxorubicin, idarubicin, mitomycin C	Disrupt cellular functions, such as RNA synthesis, or inhibit mitosis
Antimetabolites	Folic acid analogues: methotrexate Purine analogues: cladribine, fludarabine, fluorouracil 6-mercaptopurine, thioguanine Pyrimidine nucleoside analogues: arabinosyl cytosine (Ara-C, cytarabine)	Disrupt enzymatic processes or nucleic acid synthesis
Biologics	Interferon alfa Rituximab Alemtuzumab All- <i>trans</i> retinoic acid (ATRA; tretinoin)	Causes a direct antiproliferative effect on CML progenitor cells Monoclonal antibody to CD20 Monoclonal antibody to CD52 Binds antigen target on malignant lymphocyte Induces differentiation and apoptosis of malignant promyelocytes in APML
Enzymes	Asparaginase	Inhibits synthesis of asparagines, which is required for protein synthesis in leukemic lymphoblasts
Mitotic inhibitors	Vincristine, vinblastine	Act as mitotic spindle inhibitors, causing metaphase arrest
Steroid	Etoposide Prednisone	Topoisomerase II inhibitor Hormone that has antiinflammatory and antilymphocytic properties
Newer agents	Arsenic trioxide Gemtuzumab ozogamicin Decitabine Colofriline Imatinib mesylate	Inorganic compound Monoclonal antibody to CD33 Inhibits DNA methyltransferase Purine nucleoside antimetabolite Tyrosine kinase inhibitor (inhibits signal transduction in cancer cells)
Agents in clinical trials	Farnesyltransferase inhibitors Flavopiridol Lenalidomide Ofatumumab Lumiliximab	Signal transduction inhibitor Kinase inhibitor Immunomodulatory Monoclonal antibody to CD20 Monoclonal antibody to CD23

APML, Acute promyelocytic leukemia; CML, chronic myelogenous leukemia.

B-cell ALL phenotype, multiorgan involvement, and chromosomal translocations t(9;22) and t(4;11). In these patients, remission can be achieved with chemotherapy; however, the duration of remission is short. The overall long-term survival (cure) rate for adults is less than 20%.²⁸ Relapse can result in second remission in 75%, but fewer than 30% of these patients are cured.

Another concern related to treatment of patients with acute leukemia is that leukemic cells can migrate to areas in the body where chemotherapeutic agents cannot reach them. These areas are called *sanctuaries*, and they require special treatment. The most important sanctuary in patients with ALL is the CNS. Thus, patients with ALL are treated with systemic chemotherapy plus high-dose methotrexate intravenously and cytarabine or intrathecal methotrexate and radiation to the cranium plus high-dose systemic chemotherapy. Another important sanctuary (in male patients) is the testes.^{14,23,28}

Oral Manifestations of Acute Leukemia

Patients with leukemia are prone to develop gingival enlargement, ulceration, and oral infection. Localized or generalized gingival enlargement is caused by inflammation and infiltration of atypical and immature WBCs (see Fig. 23.2). It occurs in up to 36% of those with acute leukemia (most frequently with the acute myelomonocytic types) and in about 10% of those with chronic leukemia.²⁹ The gingiva is boggy and bleeds easily, and multiple tooth sites are typically affected. Generalized gingival enlargement is more common and is particularly prevalent when oral hygiene is poor and in patients who have AML (particularly the monocytic type [M5]; see Table 23.1). The combination of poor oral hygiene and gingival enlargement contributes to gingival bleeding and fetor oris. Gingival bleeding is exacerbated by the presence of thrombocytopenia. Plaque control measures,

TABLE 23.3 Medical Treatment for Leukemia and Lymphoma

Condition	Induction Chemotherapy	Consolidation Chemotherapy	Maintenance Chemotherapy	Other
AML	Daunomycin Idarubicin Cytarabine	Daunomycin Cytarabine	High-dose cytarabine	<i>Older patients:</i> gemtuzumab ozogamicin
APML	All- <i>trans</i> -retinoic acid (ATRA) Daunomycin Cytarabine	ATRA Daunomycin	ATRA	
ALL	L-Asparaginase Doxorubicin Vincristine Prednisone	Methotrexate Cytarabine	6-Mercaptopurine Methotrexate	<i>Ph chromosome–positive cases:</i> add imatinib mesylate Stem cell transplantation
CML	Imatinib mesylate	Imatinib mesylate	Imatinib mesylate	Stem cell transplantation Dasatinib, nilotinib (for cases resistant to imatinib mesylate)
CLL	Chlorambucil Fludarabine monophosphate COP regimen (cyclophosphamide, vincristine, and prednisone) Rituximab combined with fludarabine		COP adjusted to dosage that obtains desired effect or until thrombocytopenia or neutropenia develops	Radiation therapy as a palliative treatment to shrink large nodal masses or enlarged spleen Stem cell transplantation has no proven benefit
Hodgkin lymphoma	<i>Limited stage:</i> ABVD (Adriamycin [doxorubicin], bleomycin, vinblastine, dacarbazine) <i>Advanced stage:</i> ABVD or Stanford V regimen (doxorubicin, vinblastine, mechlorethamine, etoposide, vincristine, bleomycin, prednisone)			<i>Limited stage:</i> also involved-field irradiation <i>Advanced stage:</i> postchemotherapy irradiation to sites of initial or residual tumor bulk Stem cell transplantation for patients not cured by chemotherapy
Non-Hodgkin lymphoma	CHOP-R (cyclophosphamide, doxorubicin, vincristine, prednisone, rituximab) CVP-R (cyclophosphamide, vincristine, prednisone, rituximab) FCR (fludarabine, cyclophosphamide, rituximab)			Surgery for localized MALT lymphomas Splenectomy to improve cytopenias Radiation therapy

ALL, Acute lymphocytic leukemia; AML, acute myelogenous leukemia; APML, acute promyelocytic leukemia; CLL, chronic lymphocytic leukemia; CML, chronic myelogenous leukemia; MALT, mucosa-associated lymphoid tissue.

chlorhexidine, and chemotherapy promote resolution of the condition.

A localized mass of leukemic cells is specifically known as a *granulocytic sarcoma* or *chloroma*. These extramedullary tumors have been observed in the hard tissues (maxilla, palate) and soft tissues (gingiva, tongue, oral mucosa) of the maxillofacial complex.^{5,30}

CHRONIC MYELOGENOUS LEUKEMIA

DEFINITION

Chronic myelogenous leukemia is a neoplasm of mature myeloid WBCs.

EPIDEMIOLOGY

Chronic myelogenous leukemia has an incidence of 1.8 cases per 100,000 population, with 8220 cases estimated for 2016 in the United States.^{19,31} It accounts for 15% to 20% of all leukemias and is much less common than CLL in the United States.³¹ The median age at diagnosis is 64 years, and the incidence increases with age. CML is slightly more common in men than in women. CML causes 3% of childhood leukemias.³¹

Etiology

The etiology is unknown, but radiation exposure increases risk for the disease. The genetic defect consists of

TABLE 23.4 Clinical Factors in Acute and Chronic Leukemias

Factor	Type of Leukemia			
	ALL	AML	CLL	CML
Age	Children (75%)	Adults (85%)	Older than 40 years	30–50 years
Prognosis	Very good	Poor	Good	Poor
Survival time, mean	—	2 years	Stage I (19 months) Stage IV (12 years)	3–4 years —
Remissions	90%	60%–80%	—	—
Duration	Usually long term	9–24 months	—	—
Cures	50%–70%	10%–30%	—	—
	ALL	AML	CLL	CML
Age	Adults (25%)	Children (15%)	Children (rare)	Children (rare)
Prognosis	Poor	Poor	—	—
Survival time, mean	26 months	—	—	—
Remissions	50%–70%	56%–66%	—	—
Duration	10–19 months	8–12 months	—	—
Cures	20%	20–40%	—	—

ALL, Acute lymphocytic leukemia; AML, acute myelogenous leukemia; CLL, chronic lymphocytic leukemia; CML, chronic myelogenous leukemia.

Data from Wetzler M, Byrd JC, Bloomfield CD: Acute and chronic myeloid leukemia. In Kasper DL, et al, editors: *Harrison's principles of internal medicine*, ed 16, New York, 2005, McGraw-Hill and Armitage JO, Longo DL: Malignancies of lymphoid cells. In Kasper DL, et al, editors: *Harrison's principles of internal medicine*, ed 16, New York, 2005, McGraw-Hill.

translocation of the cellular oncogene *ABL* (Abelson leukemia virus gene) from chromosome 9 to the *BCR* (breakpoint cluster region) gene of chromosome 22 and a reciprocal translocation of part of *BCR* from chromosome 22 to the *ABL* gene in chromosome 9. A shortened chromosome 22, the Philadelphia (Ph) chromosome, results from the translocations and is evident in more than 90% of cases of CML.³¹ The Philadelphia chromosome also is present in ALL. Translocation contributes to increased tyrosine kinase activity and myeloid proliferation.³¹

Pathophysiology and Complications

Chronic myelogenous leukemia progresses slowly through a chronic phase for 3 to 5 years and then moves on to an accelerated phase followed by a blast phase (or crisis). More than 90% of patients, when first diagnosed, are in the chronic phase of the disease. During the chronic phase of CML, leukemic cells are functional; thus, infection is not a major problem. However, after transformation to the blastic stage has occurred, the leukemic cells are immature and nonfunctional. As a result, anemia, thrombocytopenia, and infection become problems. About 25% of patients with CML per year exhibit progression to the blast phase of the disease 6 to 12 months after diagnosis. The blast phase is characterized by 30% or more leukemic blast cells in the peripheral blood or marrow.^{31,32} More than 85% of patients with CML die in the blast phase, and patients without the Philadelphia chromosome have a worse prognosis. The overall 5-year survival rate for CML has improved from 17% in 1975 to 64.4% in recent years, in large part to the introduction of tyrosine kinase inhibitor treatment with imatinib mesylate therapy.^{31,32} Patients treated in the chronic phase with

imatinib (Gleevec) obtain complete remission, and about 70% of the patients remain in remission after 5 years. Allogeneic transplantation is associated with 10-year survival rates of 70% or better for younger patients in the early chronic phase of the disease. Patients treated in the accelerated or blast phase of the disease have a much poorer prognosis.^{31,32}

CLINICAL PRESENTATION

Signs and Symptoms

In nearly 90% of patients, CML is diagnosed during the chronic phase. Up to half of these patients are asymptomatic, and the diagnosis is based on their complete blood count (CBC). Common symptoms are fatigue, weakness, abdominal (upper left quadrant) pain, abdominal fullness, weight loss, night sweats caused by anemia, an enlarged and painful spleen (splenomegaly), and altered hematopoiesis. Hyperviscosity of the blood may cause a stroke.^{31,32}

Laboratory and Diagnostic Findings

Patients are identified by marked elevation of their WBC count during routine examination (Fig. 23.4). WBC count usually is above 50,000/ μ L at the time of diagnosis, and basophilia and eosinophilia are present. Cytogenetic analysis, a part of the standard diagnostic workup, reveals the Philadelphia chromosome in more than 90% of cases. Serum chemistry reveals elevated levels of lactate dehydrogenase (LDH) and low levels of leukocyte alkaline phosphatase. The bone marrow is markedly hypercellular.^{31,32}

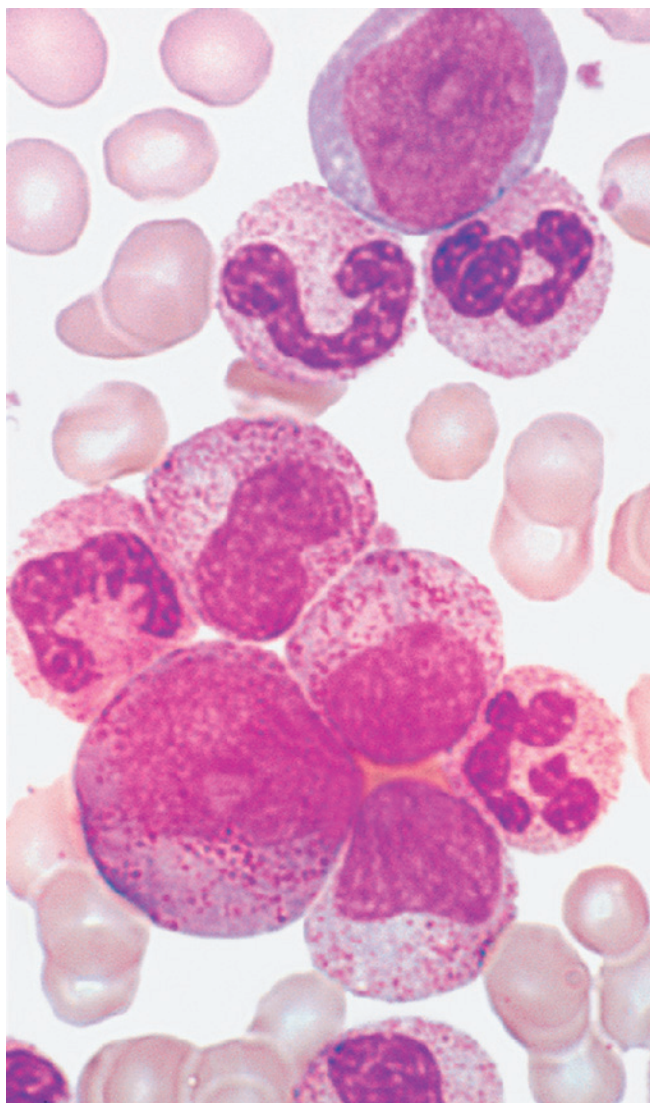

FIG 23.4 Chronic myeloid leukemia. Peripheral blood smear shows myeloblasts, promyelocytes, and segmented neutrophils. (From Hoffbrand AV, Pettit JE: *Color atlas of clinical hematology*, ed 3, London, 2000, Mosby.)

MEDICAL MANAGEMENT

Patients with CML were historically treated during the chronic phase with hydroxyurea or busulfan; this approach resulted in good symptom and blood count control along with significant toxicity. Interferon- α or imatinib mesylate (Gleevec), an inhibitor of tyrosine kinase, is widely used today.^{31,32} Two second-generation tyrosine kinase inhibitors, dasatinib and nilotinib, are being used to overcome imatinib resistance (see [Table 23.3](#)).^{31,33} Stem cell transplantation has resulted in remission in more than 70% of patients at 10 years when treatment is provided before the accelerated or blastic phase.³⁴ Stem cell transplants generally are recommended for younger patients who have an adequate human leukocyte antigen (HLA) match (see [Chapter 21](#)).

Oral Manifestations

Chronic forms of leukemia are less likely to demonstrate oral manifestations compared with acute forms of leukemia. Generalized lymphadenopathy, pallor of the oral mucosa, and soft tissue infection may be present.

CHRONIC LYMPHOCYTIC LEUKEMIA

DEFINITION

Chronic lymphocytic leukemia is a neoplasm of mature clonal CD5+ B lymphocytes.

EPIDEMIOLOGY

Chronic lymphocytic leukemia is the most common type of leukemia in adults. In 2016, 18,960 cases of CLL were estimated to occur in the United States. The incidence rate is 4.6 cases per 100,000.³⁴⁻³⁶ The median age at diagnosis is 71 years. CLL is very uncommon before the age of 45 years and infrequent in patients younger than 65 years of age. The 5-year survival rate is 82.6%, with more than 95,123 patients living with CLL.³⁶ It is more common in men than in women; however, 5- and 10-year survival rates are higher for women. It is more common in Jewish people from Russian or Eastern European ancestry. This disease is rare in Asia and in children throughout the world.³⁶

Etiology

The etiology of CLL is unknown, and risk factors are more related to familial inheritance than to exposure to harmful environmental agents. Neoplastic B cells have various genetic aberrations, most commonly gene deletions (e.g., on chromosome 11, 12, or 17) that lead to loss of cell cycle control.^{22,26} The specific genetic defect dictates the course of the disease. Cytogenetic analysis shows the following abnormalities: 13q deletion (40%–50%), 11q deletion (15%–20%), trisomy 12 (15%–20%), and 17p deletion (5%–10%). In most cases, low levels of expression of monoclonal immunoglobulin are demonstrated on the cell surface, which includes CD19, CD20, CD21, CD23, CD24, and CD38.^{32,36,37} Genetic mutations in p53 and ATM plus serum markers thymidine kinase and β_2 -microglobulin also are helpful in predicting the clinical course of CLL.³⁷

Pathophysiology and Complications

The pathophysiology of CLL relates directly to the slow lymphocytic infiltration of the bone marrow. This eventually results in marrow failure and anemia, hepatosplenomegaly, hypogammaglobulinemia (which contributes to poor wound healing), and risk for infection. Although the course of the disease is variable, the median survival period is 4 to 6 years.⁶ A possible link of CLL to Merkel

cell carcinoma of the skin has been suggested through members of the polyomavirus family.³⁸

CLINICAL PRESENTATION

Signs and Symptoms

Most patients with CLL are asymptomatic at presentation. When symptoms occur, fatigue, anorexia, and weight loss are the most common complaints. Patients have an enlarged spleen, lymphadenopathy (Fig. 23.5), and decreased serum immunoglobulin levels (hypogammaglobulinemia) that contribute to susceptibility to infection. Less frequently, patients with CLL develop autoantibodies against RBCs or platelets that produce hemolytic anemia or thrombocytopenia. In about 15% of patients, CLL evolves into a more aggressive malignancy with increasing lymphadenopathy, hepatosplenomegaly, fever, abdominal pain, weight loss, progressive anemia, and thrombocytopenia. Second malignancies occur because of immune defects associated with the disease. Survival after this transformation lasts less than 1 year.³⁹ The clinical factors and prognosis in acute and chronic leukemia are summarized in Table 23.4.

Laboratory and Diagnostic Findings

Chronic lymphocytic leukemia requires the presence of more than 5000 mature lymphocytes per microliter in the peripheral blood smear. Also evident in the smear are numerous small, round lymphocytes with scant cytoplasm. Immunotyping reveals the neoplastic cells to be B lymphocytes that are positive for CD3, CD19, CD20, CD21, CD23, and CD24.^{32,36}



FIG 23.5 Chronic lymphocytic leukemia in a 65-year-old man with bilateral cervical lymphadenopathy. (From Hoffbrand AV, Pettit JE: *Color atlas of clinical hematology*, ed 3, London, 2000, Mosby.)

Chronic lymphocytic leukemia is classified with the use of an international staging system (BINET). Three stages are identified: stage A (two or fewer lymph node groups, no anemia or thrombocytopenia), stage B (three or more lymph node groups, no anemia or thrombocytopenia), and stage C (anemia and thrombocytopenia, any number of lymph node groups). Lymph node groups include cervical, axillary, inguinal, liver, and spleen. The mean survival time for patients with stage A disease is longer than 10 years (about one third will never require treatment); with stage B, about 5 years; and with stage C, only about 2 years.^{32,36}

MEDICAL MANAGEMENT

Chronic lymphocytic leukemia is not a curable disease, and treatment has little effect on survival times. Patients in the asymptomatic phase usually are not treated. Only moderate effectiveness has been reported for some treatments in reducing lymphocyte counts and alleviating symptoms. Agents used to treat CLL are shown in Table 23.3. Rituximab, a monoclonal antibody targeting the CD20 antigen, is associated with a remission rate of about 50%, but complete remission is rare. Alemtuzumab, a monoclonal antibody that binds the CD52 antigen, has achieved short-term remissions.^{22,26} These agents are used when disease-related symptoms (e.g., fevers, chills, anemia, thrombocytopenia, hepatosplenomegaly) affect the patient's quality of life. Prednisone is used to treat autoimmune complications. Ofatumumab (an anti-CD20 monoclonal antibody) and lenalidomide (an immunomodulatory agent) are being investigated for use in patients with fludarabine resistance.⁴⁰ Stem cell transplantation has no proven benefit in terms of survival or long-term disease control. Radiation therapy is used to shrink unsightly or painful enlarged nodes or an enlarged spleen.^{32,36} Drugs that are being tested in clinical trials for the treatment of CLL include ofatumumab (CD20 monoclonal antibody), lumiliximab (CD23 monoclonal antibody), lenalidomide (an immunomodulatory drug), and flavopiridol (a chlorophenyl flavone that stimulates apoptosis that is p53 dependent).³⁶ Table 23.5 presents a comparison of acute and chronic leukemia.

Oral Manifestations

Generalized lymphadenopathy and pallor of the oral mucosa are features of CLL. Oral soft tissue infection may become evident as the patient develops hypoglobulinemia.

LYMPHOMAS

Lymphoma is cancer of the lymphoid organs and tissues that presents as discrete tissue masses. Lymphomas are classified by cell type (B cell, T cell, MALT, plasma cell), appearance (small or large cell, cleaved or noncleaved nucleus), and clinical behavior (of low, intermediate, and high grade); higher grades have been noted to be more

TABLE 23.5 Comparison of Acute and Chronic Leukemias

Parameter	Acute	Chronic
Clinical onset	Sudden	Insidious
Course (untreated)	<6 months	2–6 years
Leukemic cells	Immature	Mature
Anemia	Mild to severe	Mild
Thrombocytopenia	Mild to severe	Mild
White blood cell count	Variable	Increased
Organomegaly	Mild	Prominent
Age	Adults and children	Adults

Data from Harming DM: *Clinical hematology and fundamentals of hemostasis*, Philadelphia, 2009, FA Davis.

aggressive. Of more than 20 types, 3 common lymphomas (Hodgkin lymphoma [HL], non-Hodgkin lymphoma [NHL], and Burkitt lymphoma) and a plasma cell malignancy (MM) are considered here. These diseases are of importance in dental management because initial signs often occur in the mouth (e.g., Waldeyer ring) and in the head and neck region, and precautions must be taken before any dental treatment is provided.

In 2016, there were expected to be 81,080 new cases of lymphoma diagnosed in the United States (8500 cases of HL; 72,580 cases of NHL). There are an estimated 788,939 people living with or in remission from lymphoma in the United States. There are 181,967 people living with HL. There are 606,972 people living with NHL. The 5-year relative survival rate for people with HL has more than doubled, from 40% in whites from 1960 to 1963 (only data available) to 87.7% for all races in 2004 to 2010. The 5-year relative survival rate is 94.1% for people with HL who were younger than 45 years old at diagnosis. HL is now considered to be one of the most curable forms of cancer. The 5-year relative survival rate for people with NHL has risen from 31% in whites from 1960 to 1963 (only data available) to 71.9% for all races in 2005 to 2011. In 2015, 21,270 people were expected to die from lymphoma (1120 from HL; 20,150 from NHL).¹³

HODGKIN LYMPHOMA

DEFINITION

Hodgkin lymphoma is a neoplasm (exhibiting uncontrolled growth) of B lymphocytes that was named for Thomas Hodgkin, the British pathologist who first described it. This neoplasm contains a characteristic tumor cell called the *Reed-Sternberg cell* that represents usually less than 1% of the cellular infiltrate in affected tissues.⁴¹ For a long time, HL was referred to as Hodgkin disease and NHL as non-Hodgkin lymphoma. References cited in this book use both sets of identification.

EPIDEMIOLOGY

Hodgkin lymphoma is the most common lymphoma in young adults. HL has two peaks of incidence—one in early adulthood and the other around the fifth decade of life.⁴² Men are at slightly higher risk for developing the disease (1.4:1 male-to-female ratio).⁴² In developing countries, HL is found primarily in children, and the incidence decreases with age, in contrast with industrialized countries, where it is uncommon in children.⁴²

Etiology

The cause of HL is unknown, but EBV frequently is present (50% of cases in the Western world) in malignant lymphocytes.⁴² This virus can immortalize B cells in vitro and encodes a protein known as latent membrane protein 1 that has oncogenic potential.⁴³ Increased risk is associated with presence of the disease in first-degree relatives and with human immunodeficiency virus (HIV)–seropositive status.^{41,42}

Pathophysiology and Complications

Enlarging tumorous nodes may cause lung or vascular obstruction, and enlarging mediastinal nodes can cause cough, shortness of breath, or dysphagia. The disease spreads predictably over weeks to months, first to other lymphoid sites (other lymph nodes and spleen) and then hematogenously to extranodal sites, including the bone marrow, liver, and lung. Without treatment, death occurs as a result of complications from bone marrow failure or infection.

CLINICAL PRESENTATION

Signs and Symptoms

Hodgkin lymphoma presents most commonly as a painless mass or a group of firm, nontender, enlarged lymph nodes, often affecting the mediastinal nodes or the neck nodes (in >50% of cases) (Fig. 23.6, A).^{41,42} Enlarged lymph nodes in the underarm or groin are also common presentations. Fever, weight loss, and night sweats occur in about one third of patients.^{41,42} Pruritus and fatigue develop and may precede the appearance of enlarging lymph nodes. Palpation of the lymph nodes typically reveals a rubbery consistency.

Laboratory and Diagnostic Findings

The diagnosis of lymphoma is made on the basis of nodal biopsy or bone marrow aspirate. Microscopically, tumorous tissue typically shows large, multinucleated Reed-Sternberg reticulum (monoclonal B) cells (Fig. 23.6, B). Four pathologic variants of classic HL have been described: nodular sclerosing (65%), mixed cellularity (12%), lymphocyte-depleted type (2%), and lymphocyte-predominant type (3%). Two other variants of HL are nodular lymphocyte-predominant HL (6%) and HL not otherwise classifiable.⁴¹

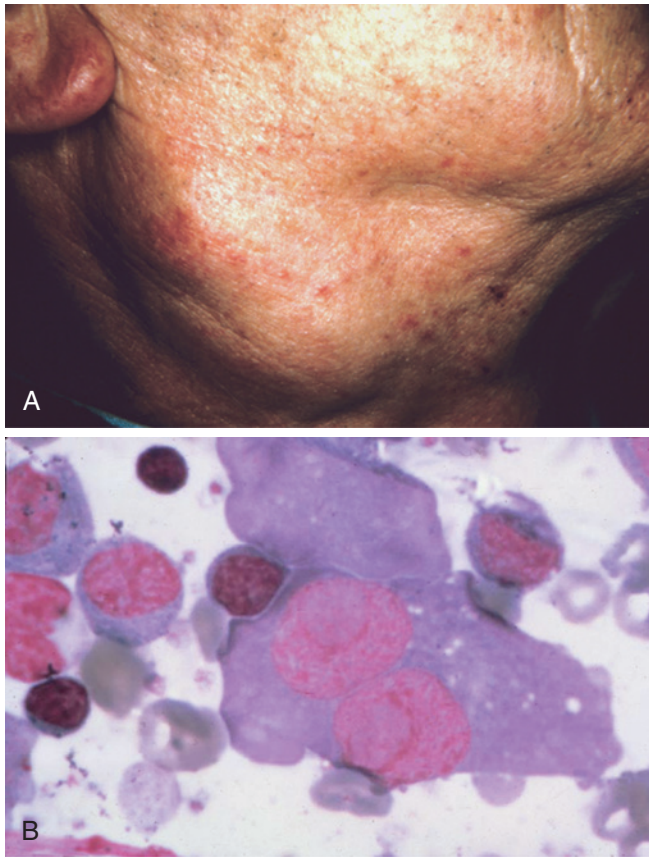

FIG 23.6 Hodgkin lymphoma. **A**, Cervical lymphadenopathy caused by tumor infiltrate. **B**, Large Reed-Sternberg cells are seen in this bone marrow specimen.

MEDICAL MANAGEMENT

Effective management requires accurate staging of the disease. Staging is performed on the basis of biopsies, medical history, physical examination findings, laboratory evaluation of the abdominal organs, and computed tomography (CT) and gallium scans that reveal the extent of disease (Fig. 23.7). Positron emission tomography (PET) is more sensitive and specific than CT or gallium scanning both for staging and for assessment of residual masses after treatment. However, it has not been proved that adding it to the standard staging imaging tests for HL will improve outcome. Thus, its primary use is in the assessment of residual masses after treatment.⁴¹ Poorer survival rates are associated with mixed cellularity and lymphocyte-depleted types, male sex, presence of *B symptoms* (>10% of baseline weight loss, night sweats, and persistent fever), a large number of involved nodal sites, and bulky disease.^{41,42}

The current cure rate for HL is about 90%.^{41,42} Historically, radiation (therapeutic dose >3.5 gray [Gy]) to involved sites was the primary mode of therapy. Contemporary strategies use a lower dose (<3.0 Gy) and more precise targeting of radiation to involved sites after disease volume has been reduced by chemotherapy.⁴² Table 23.3

summarizes the treatment regimen for patients with limited and advanced-stage HL (stages IIIA, IIIB, IVA, and IVB).⁴¹

Relapses, if they occur, generally occur within 2 years of therapy and seldom appear after 5 years. To prevent relapse, those who have received radiation therapy alone are provided subsequent ABVD (Adriamycin [doxorubicin], bleomycin, vinblastine, dacarbazine) chemotherapy (known as *salvage therapy*). If relapse occurs after standard radiation regimens or chemotherapy, autologous peripheral stem cell transplantation is recommended.^{41,42}

Long-term complications of chemotherapy and radiation therapy used to manage patients with HL can occur in the lungs, heart, thyroid, breasts, and gonads. Radiation pneumonitis occurs in 5% to 10% of irradiated patients with mediastinal lymphadenopathy. Myocarditis, myocardial necrosis, arrhythmias, myocardial infarction, and pericarditis occur in 2% to 4% of patients receiving chemotherapy and radiation treatment. Valvular heart disease and coronary artery disease have been reported as late complications of radiation therapy to the chest area. Secondary neoplasia is a complication of treatment of HL and includes acute leukemia, lung cancer, breast cancer, and thyroid cancer.⁴²

NON-HODGKIN LYMPHOMA

DEFINITION

Non-Hodgkin lymphoma comprises a large group of lymphoproliferative disorders classified as of B- or T-cell origin. More than 80% of these neoplasms are of B-cell origin.⁶ The WHO classification system uses immunophenotype, cytogenetics, and epidemiologic or etiologic factors to distinguish the many types of NHL. Four major categories of NHL are described: precursor (immature) B-cell neoplasms, peripheral (mature) B-cell neoplasms, precursor (immature) T-cell neoplasms, and peripheral (mature) T-cell and NK cell neoplasms.^{6,44} Subcategories are based on pattern of distribution (diffuse or nodular), cell type (lymphocytic, histiocytic, mixed), and degree of differentiation of cells (good, moderate, poor). Of the more than 20 types of NHL that have been identified, diffuse large B-cell lymphoma (DLBCL) and follicular lymphomas account for about 60% of cases.⁴⁵ Recent updates to the WHO guidelines of NHL classification include recognition of borderline entities, the most common being DLBCL/Burkitt lymphoma (DLBCL/BL), which has features of both conditions.⁴⁶

EPIDEMIOLOGY

In 2016, 72,580 cases of NHL were estimated to occur in the United States.¹⁹ The incidence rates increased dramatically from 1950 to 1970 and then doubled since the early 1970s to 2000.^{47,48} Since the late 1990s, the incidence of NHL has declined slightly.^{47,48} All races and age groups are affected. NHL is the seventh most common

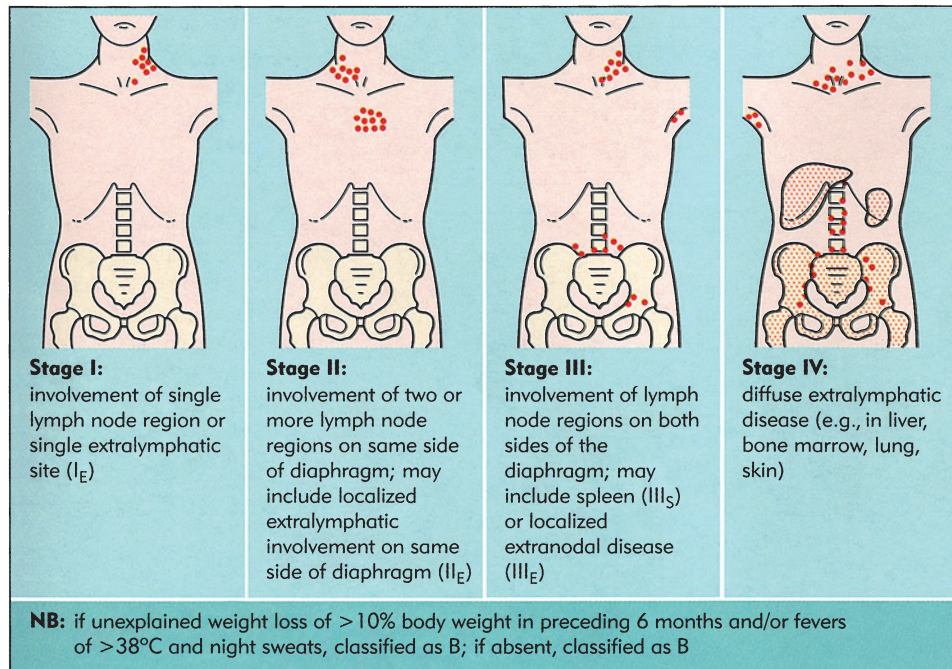

FIG 23.7 Ann Arbor staging system for Hodgkin lymphoma. (From Hoffbrand AV, Pettit JE: *Color atlas of clinical hematology*, ed 4, London, 2010, Mosby. Originally modified from Hoffbrand AV, Pettit JE: *Essential haematology*, ed 3, Oxford, 1993, Blackwell Science Publications.)

cancer in the United States.²⁴ NHL results in about 21,000 deaths per year and is the seventh leading cause of death in the United States.^{13,19,48} The median age at the time of diagnosis is 66 years.⁴⁹

Etiology

The cause of NHL is unknown, but genetic factors, infectious agents, herbicides, radiation, and some forms of chemotherapy are increasingly recognized as causative agents. At the molecular level, malignant lymphocytes have chromosomal translocations or mutations in genes that regulate lymphocyte growth (*BCL6*) or survival (*BCL2*). Persistent inflammation from *Helicobacter pylori* infection of the stomach contributes to gastric lymphoma. Oncogenic viruses such as EBV, Kaposi sarcoma herpesvirus (KSHV), and retroviruses are associated with several types of NHL. Patients with autoimmune disease (Sjögren syndrome) or immunodeficiency states (acquired immunodeficiency syndrome [AIDS], after chemotherapy) are at increased risk for the disease.⁴⁵

Pathophysiology and Complications

The course of NHL varies from highly proliferative and rapidly fatal disorders (aggressive) to slowly progressing (indolent) malignancies that are tolerated for 10 to 20 years.^{48,50} Tumorous cells behave in similar fashion to that for the cell of origin: Tumorous B cells home to follicular regions of lymph nodes, and T cells have a propensity for paracortical T cell zones. These neoplasms cause tumorous enlargements and abnormalities of the

immune system. Tumors often are widespread at the time of diagnosis and more variable in location (involving various organs such as liver and spleen) than in Hodgkin disease. Anemic and leukemic manifestations are common.

CLINICAL PRESENTATION

Signs and Symptoms

Non-Hodgkin lymphoma may occur at any age and often is marked by enlarged lymph nodes, fever, and weight loss. In contrast with Hodgkin disease, which often begins with a single focus of tumor, NHL usually is multifocal when first detected.^{47,48,50} About 20% to 40% of lymphomas develop outside of lymph nodes and are termed *extranodal lymphomas*.⁵ The most prominent sign of NHL is a painless lymph node(s) swelling of longer than 2 weeks' duration. Additional signs and symptoms include persistent fever of unknown cause, weight loss, malaise, sweating, tender lymphadenopathy, abdominal or chest pain, and, on occasion, extranodal tumors.^{13,48,50} *B symptoms*, defined as fever, drenching night sweats, and weight loss of more than 10%, as seen with HL, indicate a more aggressive clinical course.^{48,50}

Laboratory and Diagnostic Findings

The diagnosis of NHL is based on findings on excisional biopsy of the involved lymph node. Tumorous cells are classified first by lineage (B, T, or NK cell) and second by level of differentiation. Immunologic and molecular genetic assays are performed to facilitate diagnosis. Proper

staging of disease requires CBC count, chemistry screen, chest radiographs, CT scans, and bone marrow biopsy.

MEDICAL MANAGEMENT

Medical treatment of patients with the two most common NHLs (follicular lymphoma and DLBCL) is reviewed in this section. Follicular lymphoma is radiosensitive, and the typical total dose is 35 Gy. Asymptomatic patients, older adults, and patients with other medical illnesses can be managed by an observational approach. However, most patients with follicular lymphoma will require treatment, with 30% to 50% of the neoplasms undergoing histologic transformation to DLBCL. Once the patient becomes symptomatic, selective therapy can be started.

About 5% to 15% of patients with follicular lymphoma have localized disease, which usually is treated with involved-field irradiation, with overall survival rates of 60% to 70%. Most patients with follicular lymphoma have extensive disease at diagnosis. The median survival time for these patients is 8 to 10 years. Treatment protocols are shown in [Table 23.3](#).^{47,48,50} In addition, radiation therapy is used for patients with a localized site of symptomatic disease.

About 30% of patients with DLBCL have stage I or minimal stage II disease. Although some of these patients may occasionally be cured with radiation therapy alone, the more effective treatment is chemotherapy followed by radiation therapy (see [Table 23.3](#)).

Stem cell transplantation and monoclonal antibodies against antigens expressed by malignant lymphocytes (in addition to rituximab, ¹³¹I-tositumobab and ⁹⁰Y-ibritumomab are approved by the U.S. Food and Drug Administration for treatment of NHL), combined with chemotherapy (cisplatin, etoposide, carboplatin, and ifosfamide), help patients who respond poorly to traditional therapies (see [Table 23.3](#)). Extranodal lymphomas in the oral or pharyngeal region have a poor prognosis. [Table 23.6](#) compares the findings of Hodgkin disease and NHL and emphasizes that disease-free survival with NHL is poor.

Oral Complications and Manifestations

Patients with HL or NHL may develop cervical lymphadenopathy and extranodal or intraoral tumors ([Fig. 23.8](#)). Lymphoma in the oral cavity usually appears as extranodal disease.⁵ This situation is of particular concern in immunosuppressed patients and in those with Sjögren syndrome, who are at increased risk for the development of lymphoma. These patients should be periodically monitored for the development of orofacial neoplasia.⁵

Intraoral lymphoma most commonly involves Waldeyer ring (soft palate and oropharynx)⁵¹; less often, the salivary glands and mandible are affected. Intraoral lymphomas appear as rapidly expanding (or chronic), nonspecific swellings of the head and neck lymph nodes, palate, gingiva,

TABLE 23.6 Comparison of Hodgkin and Non-Hodgkin Lymphomas

Parameter	Hodgkin Lymphoma	Non-Hodgkin Lymphoma
Cellular derivation site	B cell	>80% B cell, 10%–19% T cell or NK cell
Localized	Common	Uncommon
Waldeyer ring	Rarely involved	Commonly involved
Extranodal	Uncommon	Common
Abdominal (mesenteric nodes)	Uncommon	Common
Mediastinal	Common	Uncommon
Bone marrow	Uncommon	Common
“B” symptoms (fever, night sweats, weight loss)	Common	Uncommon
Curability	>75%	<25%

NK, Natural killer.

Data from Armitage JO, Longo DL: Malignancies of lymphoid cells. In Kasper DL, et al, editors: *Harrison's principles of internal medicine*, ed 16, New York, 2005, McGraw-Hill.



FIG 23.8 Non-Hodgkin lymphoma manifesting as a gingival enlargement that also involved the underlying alveolar bone (A) and an osteolytic lesion of the mandible (B).

buccal sulcus, or floor of the mouth. Enlargements may be painless or painful. Infrequent findings include deep “crateriform” oral ulcers and fever.⁵² The presence of these orofacial abnormalities requires prompt evaluation by biopsy using needle, incisional, or excisional techniques.

Patients with lymphoma who have received medical treatment for their disease sometimes report burning mouth symptoms, similar to those noted by patients with leukemia, which may be related to drug toxicity, xerostomia, candidiasis, or anemia (see [Appendix C](#) for management regimens). Patients who have received more than 25 Gy are susceptible to xerostomia and would benefit from salivary substitutes or pilocarpine.⁵¹ Radiation also can damage taste buds, cause trismus of the masticatory muscles, and stunt craniomandibular growth and development. Osteoradionecrosis is a long-term risk associated with radiation doses to the jaws in excess of 50 Gy. The usual dose of irradiation to patients with lymphoma seldom puts them at risk for osteoradionecrosis, but they may develop xerostomia.⁵¹ Protocols to reduce the risk of osteoradionecrosis are discussed in [Chapter 26](#).

Head, neck, and intraabdominal manifestations occur fairly often. Less frequently, an oral presentation (e.g., as a firm swelling arising from the posterior hard palate) may be seen.⁵¹

BURKITT LYMPHOMA

DEFINITION

Burkitt lymphoma is an aggressive B-cell (non-Hodgkin) lymphoma that originally was described by Denis Burkitt.⁵³ The tumors are composed of mature B cells that express surface IgM.

EPIDEMIOLOGY

Burkitt lymphoma is the most common lymphoma of childhood. It affects children and young adults at a rate of 0.05 cases per 100,000.^{26,45} Three types are commonly described: endemic, sporadic, and immunodeficiency associated. Burkitt lymphoma that is found most often in Central Africa is known as *endemic Burkitt lymphoma* and affects children with a peak prevalence of about 7 years of age.⁵ More than 50% to 70% of endemic cases present in the jaws (90% in 3-year-old patients and 25% in patients older than age 15 years).⁵ Sporadic (nonendemic) Burkitt lymphoma is more common in Western societies and affects slightly older children and adults in their 30s. Immunodeficiency-associated Burkitt lymphoma occurs in persons infected with HIV. Burkitt lymphoma is more common among men.^{5,6}

Etiology

Burkitt lymphoma is a mature B-cell lymphoma expressing surface immunoglobulin, usually IgM. All Burkitt lymphomas are associated with translocation of the *c-myc* gene (a gene involved in cellular proliferation) onto chromosome 8. In most cases, the immunoglobulin gene is translocated to chromosome 14 [t(8;14)], but it may also be translocated to chromosome 2 [t(2;8)] or 22 [t(8;22)].⁵⁴ These regions regulate immunoglobulin class

(isotype) switching. Recent studies have suggested that mutation of the *TP53* gene may play a role in the development of Burkitt lymphoma.⁵⁴ More than 90% of endemic tumors contain latent EBV. EBV is present in about 15% to 20% of sporadic lymphomas and in about 25% of HIV-associated tumors.^{5,54}

Pathophysiology and Complications

This malignancy is very aggressive and grows very rapidly. Tumors can double in size every 3 days; thus, obstruction of the airway, alimentary canal, and vasculature is possible. The tumor also has a propensity for spread to the CNS.

CLINICAL PRESENTATION

Signs and Symptoms

Most Burkitt lymphomas arise at extranodal sites. The endemic form shows a predilection for tumors of the jaw and for involvement of select abdominal organs, particularly the kidneys, ovaries, and adrenal glands. Jaw involvement is more common in patients younger than 5 years of age than among those older than age 10 years ([Fig. 23.9](#)). Nonendemic Burkitt lymphoma often presents as an abdominal mass that involves the lymph nodes of the intestine and peritoneum, with jaw lesions being less common. Tumors that enlarge as abdominal masses are accompanied by fluid accumulation, pain, and possibly vomiting. The bone marrow is infrequently involved.



FIG 23.9 Burkitt lymphoma showing characteristic facial swelling caused by extensive tumor involvement of the mandible and surrounding soft tissues. (From Hoffbrand AV, Pettit JE: *Color atlas of clinical hematology*, ed 4, London, 2010, Mosby. Courtesy of Prof. J.M. Chessells.)

Laboratory and Diagnostic Findings

The diagnosis is based on radiographic features and a histologic pattern of numerous small, noncleaved atypical B (CD10) lymphocytes interspersed with lightly stained histiocytes (“starry sky” pattern) (Fig. 23.10). Histologically, tumor cells are darkly stained and have small prominent nucleoli and a high mitotic index (feature of malignancy).⁶ Intraoral radiographs of tumors of the endemic type reveal osteolytic jaw lesions with ill-defined margins and tooth displacement (floating teeth). Usually these develop distal to the last mandibular molar.

MEDICAL MANAGEMENT

The disease responds well to high-dose chemotherapy. Tumors are particularly sensitive to cyclophosphamide. Combination chemotherapy with vincristine, doxorubicin, methotrexate, or cytarabine has achieved remission in

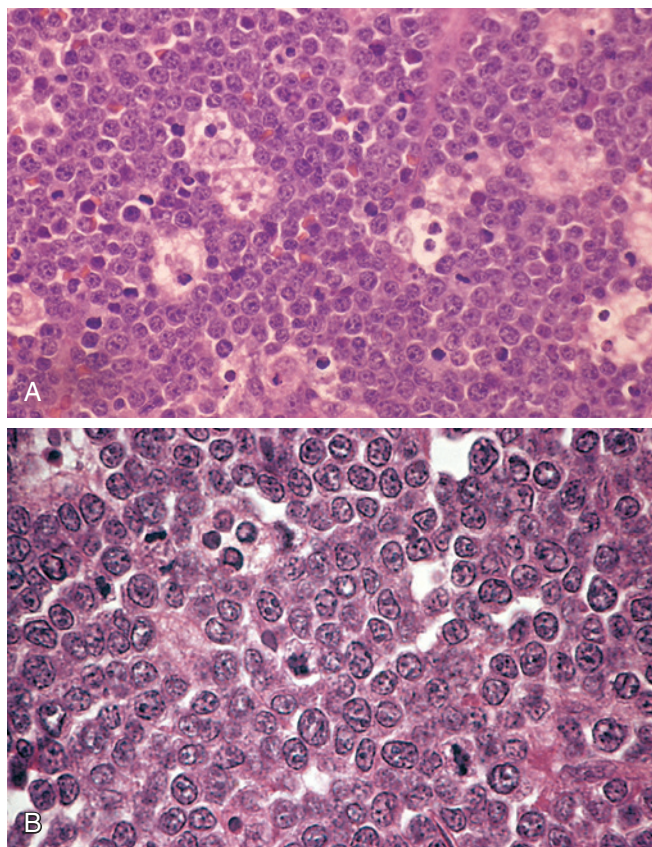

FIG 23.10 Burkitt lymphoma. **A**, At low power, numerous pale macrophages are evident, interspersed among the tumor cells, producing a “starry sky” appearance. **B**, At high power, tumor cells are seen to have multiple small nucleoli and a high mitotic index. (A and B from Kumar V, Abbas A, Fausto N, editors: *Robbins & Cotran pathologic basis of disease*, ed 7, Philadelphia, 2005, Saunders. B courtesy of Dr. Jose Hernandez, Department of Pathology, University of Texas Southwestern Medical School, Dallas, TX.)

more than 90% of patients. Those who live beyond 2 years often experience long-term remission.⁵⁵

Oral Complications and Manifestations

Endemic Burkitt lymphoma often presents as a rapidly expanding tumorous mass in the posterior region of the maxilla or mandible with about 50% to 70% of the cases with jaw lesions.⁵ Rapid growth displaces adjacent teeth, resulting in mobile and abnormally positioned teeth. Pain and paresthesia accompany the condition. Radiographically, the tumor produces an osteolytic lesion with poorly demarcated margins, erosion of the cortical plate, and soft tissue involvement.

MULTIPLE MYELOMA

DEFINITION

Multiple myeloma is a lymphoproliferative disorder that results from overproduction of cloned malignant plasma cells that results in multiple tumorous masses scattered throughout the skeletal system. Malignant plasma cells secrete monoclonal immunoglobulins and various cytokines. Monoclonal gammopathy of undetermined significance (MGUS), consisting of increased numbers of plasma cells with no other clinical manifestations, may precede MM. Another condition preceding full-blown MM is smoldering myeloma, which is an early form of MM not associated with overt clinical signs and symptoms.¹⁹

EPIDEMIOLOGY

An estimated 30,330 new cases of myeloma (17,900 males and 12,430 females) were expected to be diagnosed in the United States in 2016. An estimated 103,463 people in the United States are living with or in remission from myeloma. The 3-year survival rate as of January 1, 2011, was 60% (for all races and ethnicities). Approximately 12,650 deaths from myeloma were anticipated in 2016.^{12,13} The lifetime risk for MM is 1 in 159 (0.68%).¹⁹ The median age at diagnosis of MM for men is 69 years and 71 years for women.^{56,57} The disease is diagnosed in fewer than 5% of patients younger than 40 years of age.⁵⁷

Etiology

The etiology of MM is unknown but involves uncontrolled division of a clonal cell that produces daughter cells of the same genetic makeup. Chromosomal translocations that frequently involve the immunoglobulin heavy chain locus (IgH) at 14q32 are common. The translocated gene is placed under transcriptional control of potent IgH enhancers, resulting in their overexpression.^{57,58} Deletions in chromosome 13 (accounting for 30% of cases) and chromosome 17 have been reported. Malignant plasma cells express certain cluster differentiation glycoproteins on the surface: CD38, CD56, CD138, and CD20 in 20% of cases. Abnormalities of the following oncogenes has

been reported: c-Myc (early), N-ras and K-ras (late), and p53.¹⁹ Various cytokines (interleukin [IL] 1 α and RANKL [receptor activator for nuclear factor- κ B ligand]) are also overproduced. Production of IL-6 by neoplastic plasma cells and normal stromal cells aids in the proliferation of tumor cells. Additional cytokines act as osteoclast-activating factors that stimulate osteoclasts to resorb bone.^{19,57-59}

Pathophysiology and Complications

The disease consists of plasma and myeloma cell proliferation, immunoglobulin production, bone resorption at tumor sites, and bone marrow replacement. Resorption of bone leads to release of calcium and serum hypercalcemia. Bone marrow replacement leads to anemia, leukopenia, thrombocytopenia, and eventually a decrease in plasma immunoglobulins. During the early to middle stages of disease, increased plasma viscosity contributes to altered platelet function, excessive bleeding, renal impairment, and neuropathy. Renal failure results from tubular damage caused by excretion of light chains (of immunoglobulin) or by glomerular deposition of amyloid, hyperuricemia, recurrent pyelonephritis, or local infiltration of tumor cells. Infections are common because of diffuse hypogammaglobulinemia (an immune deficiency state) that is caused by decreased production of normal antibodies. Infection is a primary cause of death in MM. Renal failure is the second most common cause of death.^{19,57-59}

CLINICAL PRESENTATION

Signs and Symptoms

The most prominent feature of MM is observed radiographically. This disease produces multiple “punched-out” lesions or mottled areas, which represent areas of tumor that appear in the spine, ribs, and cortical regions of the skull (Fig. 23.11). Osteolytic lesions of the jaw occur in up to 30% of patients. Amyloid deposition is seen in various soft tissues (heart, liver, nervous system). Because of hypogammaglobulinemia, pneumonia and pyelonephritis commonly develop.

The most prominent symptom is persistent bone pain. The sites most commonly affected are along the spine, ribs, and sternum. As bone marrow is replaced, anemia develops, along with associated features of weakness, weight loss, and recurrent infection. Headache and peripheral neuropathy are associated with hypercalcemia. Tumor destruction of bone may cause pathologic fracture.

Laboratory and Diagnostic Findings

Osteolytic bone lesions, elevated serum calcium, increased immunoglobulins in the blood, abnormal immunoglobulin light chains (Bence-Jones proteins) in the urine, anemia (normocytic and normochromic), neutropenia, and thrombocytopenia are features of MM. The diagnosis is typically confirmed by protein electrophoresis of

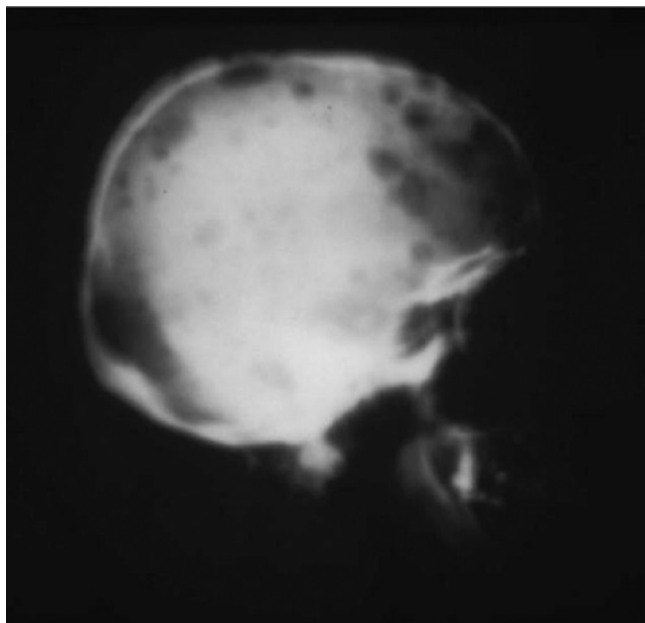

FIG 23.11 Multiple myeloma. Punched-out lytic lesions in the skull containing malignant plasma cells.

serum or urine that shows the presence of the myeloma or monoclonal (M) protein band. The immunoglobulin most commonly detected is IgG followed by IgA and IgM. Tumor biopsy reveals sheets of plasmacytoid cells. Bone marrow aspirates show monoclonal plasma cells that constitute more than 30% of the marrow cellularity. Elevated blood urea nitrogen and serum creatinine indicate renal involvement. Low serum albumin level and increasing levels of β_2 -microglobulin indicate a poorer prognosis.^{19,57,58}

MEDICAL MANAGEMENT

Treatment of patients with MM is shown in Table 23.7. Thalidomide and proteasome inhibitors (bortezomib) are also used. Thalidomide is a potent inhibitor of angiogenesis and immune response (it inhibits secretion of tumor necrosis factor- α and IL-6). Proteasome inhibitors block proteases required for the accumulation of regulatory proteins important in cell cycle control. Radiation therapy is used as palliative treatment (see Table 23.7).

Interventions are provided to manage anemia, prevent infection, and treat or prevent bone disease. Usually, anemia is controlled with recombinant erythropoietin. Intravenous immunoglobulins and antibiotics are given selectively to prevent infection. Bisphosphonates are used to maintain bone strength and to reduce bone pain in early-stage and advanced disease.^{19,57-59}

According to the International Staging System, median survival can be predicted on the basis of serum β_2 -microglobulin and serum albumin levels (Table 23.8). Patients with low levels of β_2 -microglobulin (<3.5 mg/L) and high albumin levels (< 3.5 mg/dL) have an estimated survival time of 62 months from the time of diagnosis,

TABLE 23.7 Treatment of Multiple Myeloma

Type of Therapy	Agent(s) or Technique(s)	Complications
Traditional chemotherapy	Melphalan Vincristine Cyclophosphamide Carmustine Doxorubicin Etoposide (VP-16) Doxorubicin Bendamustine	Hair loss Mouth sores (ulceration) Loss of appetite Nausea and vomiting Low blood counts Increased risk of infection Bleeding and bruising Tiredness
Corticosteroids	Dexamethasone Prednisone	Increased blood sugar Increased appetite Problems sleeping Infection (weakened immune system)
Immunomodulating agents	Thalidomide Lenalidomide	Sleepiness Tiredness Nerve damage Infection (decrease in WBCs) Bleeding (decrease in platelets)
Other drugs	Bortezomib (proteasome inhibitor)	Nausea and vomiting Tiredness Diarrhea or constipation Bleeding and bruising Decreased appetite Fever Peripheral neuropathy
Bisphosphonates (slow the rate of bone resorption)	IV pamidronate (Aredia) IV zoledronic acid (Zometa)	Osteonecrosis of the jaws
Radiation therapy (for bone lesions that do not respond to drugs for pain relief)		
Surgery (relieve spinal cord compression, placement of rods for long bone support)		
Biologic therapy	Interferon (prolong remissions) Erythropoietin (increase RBC numbers)	Tiredness Flu-like symptoms
STEM CELL TRANSPLANTATION		
Autologous	Tandem transplant	Infection
Allogeneic	Use of graft-versus-tumor effect	GVHD
Nonmyeloablative (mini-transplant)	Marrow not completely killed	
Plasmapheresis	Used to reduce hyperviscosity of blood in advanced cases of MM	

GVHD, Graft-versus-host disease; IV, intravenous; MM, multiple myeloma; RBC, red blood cell; WBC, white blood cell.

but patients with high β_2 -microglobulin levels (>5.5 mg/L) have a median survival time of 29 months.^{19,57,59} Reported 5-year survival rates for MM, based on data up to 2006, range from 28% to 41%.⁶⁰

Oral Complications and Manifestations

Patients with MM may have jaw lesions, soft tissue lesions, and soft tissue deposits of amyloid. Bone and soft tissue lesions often are painful.⁵¹ Dental radiographs may show “punched-out” lesions or mottled areas that represent areas of tumor. These osteolytic lesions are more common in the posterior body of the mandible and may be associated with cortical plate expansion. Extramedullary plasma cell tumors can occur in the oropharynx. An amyloid-like protein is found sometimes in oral soft tissues (e.g., tongue)

as a result of MM, and these areas may be swollen and painful. Biopsy and special amyloid stains can be used for diagnosis.⁵¹

DENTAL MANAGEMENT

Medical Considerations

Identification. A thorough assessment for evidence of WBC disorders is essential in all patients who present for dental treatment. Clinical recognition of such disorders is critical because patients with leukemia or lymphoma may be at risk for catastrophic outcomes if the disease is not detected before dental treatment is started. Patients with leukemia whose disease has not been diagnosed may experience serious bleeding complications after surgical procedures,

TABLE 23.8 Staging and Prognostic Factors in Multiple Myeloma

Staging and Prognostic Factors	Median Survival Time
I. INTERNATIONAL STAGING SYSTEM (SERUM β_2-MICROGLOBULIN AND ALBUMIN)	
Stage I (serum β_2 -microglobulin <3.5 mg/L and serum albumin >3.5 g/dL)	62 months
Stage II (neither stage I or III)	44 months
Stage III (serum β_2 -microglobulin >5.5 mg/L)	29 months
II. RISK STRATIFICATION	
High-risk myeloma—any of the following: Karyotyping: deletion 13 or hypodiploidy Molecular genetics: t4;14, t14;16, deletion 17p Plasma cell labeling index >3%	24–36 months
III. OTHER ADVERSE PROGNOSTIC FACTORS	
Elevated lactate dehydrogenase level Poor performance status Increased circulating plasma cells Plasmablastic morphology High C-reactive protein level	

From Goldman L, Ausiello D, editors: *Cecil medicine*, ed 23, Philadelphia, 2008, Saunders.

may have altered healing of surgical wounds, and are prone to postsurgical infection. Thus, it is important for the dentist to attempt to identify these patients through history and clinical examination before starting any treatment.

Physical evaluation requires a consistent approach by which important medical, historical, and clinical information is obtained from the patient. Specific questions regarding blood disorders and cancer in family members, weight loss, fever, swollen or enlarged lymph nodes, and bleeding tendencies should be asked. In addition, the dentist should emphasize the importance of routine annual physical examinations that will provide hematologic assessment for potential abnormalities.

After the history is complete, clinical examination is mandatory. Examination of the head, neck, and mouth should include a thorough inspection of the oropharynx, head, and cervical and supraclavicular lymph nodes. The dentist should be cognizant that an enlarged supraclavicular node is highly suggestive of malignancy. Cranial nerve examination is important for identifying abnormalities suggestive of invasive neoplasms. Panoramic films also provide insight into potential osteolytic lesions associated with WBC disorders (see Fig. 23.8).

A patient who displays the classic signs or symptoms of leukemia, lymphoma, or MM should be promptly referred directly to a physician. Patients with signs and symptoms suggestive of these disorders should be screened by appropriate laboratory tests or biopsy of soft tissue and osseous lesions. Referral to a surgeon for excisional

biopsy of a lymph node may be required. Screening laboratory tests can be conducted at a commercial clinical laboratory or in a physician's office. Screening tests should include a CBC with differential (total and differential WBC counts, hemoglobin, hematocrit, platelet count) and a smear for cell morphologic study. If screening tests are ordered by the dentist and one or more results are abnormal, the patient should be promptly referred for medical evaluation and treatment. Biopsy specimens that contain WBCs should be immunophenotyped with the use of a panel of monoclonal antibodies. Immunophenotyping allows determination of the cell of origin (B or T cell or nonlymphoid). Accurate diagnosis also requires culturing of WBCs for analyses of the chromosomes through cytogenetic methods.

Treatment Planning Modifications

Dental management of patients in whom a WBC disorder is diagnosed requires consideration of the three phases of medical therapy. Planning involves (1) pretreatment assessment and preparation of the patient; (2) oral health care during medical therapy; and (3) posttreatment management, including long-term considerations and possible remission.

Pretreatment Evaluation and Considerations. The dentist must be aware of the specific diagnosis, severity of the disorder, type of treatment selected for the patient, and whether the WBC disorder can be effectively managed through consultation with the patient's physician. Full knowledge of this information is required for effective decision making regarding dental treatment. For example, a patient who is receiving only palliative treatment is not a good candidate for extensive restorative or prosthodontic procedures that require months for completion.

For patients in whom leukemia or lymphoma has been recently diagnosed, the dentist should become involved early during the treatment planning stages of cancer therapy. Guidance regarding the health of the oral cavity and jaws can help prevent severe oral complications (i.e., infection). Accordingly, pretreatment assessment should include a thorough extraoral and intraoral examination, panoramic film, and review of blood laboratory findings, with the overall goal of minimizing or eliminating oral disease before the start of chemotherapy. Inspection of radiographs for undiagnosed or latent disease, retained root tips, impacted teeth, and latent osseous disease is important for eliminating disease from the oral cavity.

Pretreatment care should include oral hygiene instructions that emphasize the importance of meticulous plaque removal. Caries and infection should be eliminated, if possible, before chemotherapy is begun, and treatment should be directed first toward acute needs (e.g., periapical disease, large carious lesions treated before small lesions). If pulpal disease is present, the dentist may recommend root canal therapy or extraction of teeth before chemotherapy. Dental attention is given to oral hygiene procedures, including using fluoride gels, encouraging a noncariogenic diet, eliminating mucosal and periodontal

disease, eliminating sources of mucosal injury, and protecting the salivary glands (with lead-lined stents or drugs) if head and neck irradiation is planned. Extraction should be considered if periodontal pocket depths are greater than 5 mm, periapical inflammation is present, the tooth is nonfunctional or partially erupted (as with third molars), or the patient is noncompliant with oral hygiene measures and routine dental care.⁶¹

Guidelines for extraction in patients before chemotherapy include scheduling a minimum of 10 to 14 days (3 weeks preferable) between the time of extraction and initiation of chemotherapy or radiotherapy, attaining primary closure, avoiding invasive procedures if the platelet count is less than 50,000/ μL , and transfusing if the platelet count is less than 40,000/ μL . It is important to note that chemotherapy is initiated in many cases of acute leukemia within a few days of diagnosis, so dental treatment may have to be provided promptly before the patient becomes neutropenic as a result of chemotherapy.

Patients who are neutropenic should not undergo invasive dental procedures without special preparation and precautions. The patient's physician may select to use recombinant human granulocyte colony-stimulating factor to promote growth and differentiation of neutrophils before surgical procedures.

There is a lack of evidence-based literature regarding antimicrobial prophylaxis for neutropenic patients undergoing dental procedures. The latest recommendations in the oncology literature support the use of fluoroquinolones for antimicrobial prophylaxis if the absolute neutrophil count (ANC) is less than 1000 for more than 7 days but does not indicate if this is appropriate for dental procedures.⁶¹ At present, best evidence suggests that dentists should consult with the patient's physician to discuss need for antibiotic prophylaxis and appropriate choice of antimicrobial and dosing regimen in patients who have ANCs of 1000 or greater.⁶²

Medical Complications. Patients who are undergoing chemotherapy or radiotherapy are susceptible to many oral complications, including mucositis, neutropenia, infection, excessive bleeding, graft-versus-host disease (GVHD), and alterations in growth and development. Fortunately, improved therapy protocols have resulted in a decline in the incidence (to $\approx 30\%$ of cases) of oral complications.

Mucositis. Mucosae of the mouth and gastrointestinal tract grow rapidly and are likely to be affected by cancer therapy. Thus, these patients often develop mucositis, which usually begins 7 to 10 days after initiation of chemotherapy and resolves after cessation of chemotherapy. Cytotoxic agent treatments affect epithelial cells that have high replication rates. Thus, younger persons have a greater prevalence of mucositis of nonkeratinized sites (ventral tongue, labial and buccal mucosa, floor of mouth) and are more severely affected.⁶³ Affected mucosa becomes red, raw, and tender. Breakdown of the epithelial barrier produces oral ulcerations that may become secondarily

infected and can serve as a source of systemic infection. Oral hygiene should be maintained to minimize infection complications. A bland mouth rinse can be used to clean the surface of the ulcer. (Commercial mouth rinses are not recommended because they contain alcohol and tend to irritate ulcerated tissues.) After the bland mouth rinse, use of a topical anesthetic and systemic analgesics makes the mouth more comfortable. Various solutions of antihistamines (benzylamine) that have local anesthetic properties are effective, and a thin layer of Orabase is useful in protecting ulcers from surface irritation. (See [Appendix C](#) for suggested regimens.⁶⁴) This protocol can be repeated four to six times a day. In addition, palliative care may include removal of sharp edges of teeth and restorations. Antiseptic and antimicrobial rinses (e.g., chlorhexidine) are recommended to promote healing of oral ulcerations and to prevent oral infection.⁶⁵ Additional novel cytoprotective agents (e.g., amifostine, keratinocyte growth factor [palifermin]) can be considered for patients not responding to other agents.⁶³

Neutropenia and Infection. Patients may present with neutropenia alone, neutropenia combined with leukemia or lymphoma, or neutropenia that results from medical treatment (chemotherapy or drug induced) ([Fig. 23.12](#)). Patients who have neutropenia are unable to provide a protective response against oral microbes. Accordingly, these patients develop acute gingival inflammation and mucosal ulcerations. Chronic neutropenia contributes to severe destruction of the periodontium with loss of attachment when oral hygiene is less than optimal. Periodontal therapy that includes instruction on oral hygiene, frequent scaling, and antimicrobial therapy can reduce the adverse effects associated with this disorder.²⁹

Oral infection is less of a problem in patients with chronic leukemia than in those with acute leukemia because



FIG 23.12 Oral ulcers caused by neutropenia.

the cells are more mature and functional in chronic leukemia. However, in the later stages of both CML and CLL, infection can become a serious complication. Splenectomy because of massive splenomegaly may also increase the risk of infection.

Because of neutropenia, signs of infection are often masked in patients with leukemia. The swelling and erythema usually associated with oral infection are often less distinctive. In these patients, severe infection can occur with minimal clinical signs, which can make clinical diagnosis more difficult. Infections often develop in the presence of neutropenia as the result of invasion by unusual oral pathogens (i.e., bacteria that do not cause oral infection in most patients seen by the dentist). Unusual infections may be caused by *Pseudomonas* spp., *Klebsiella* spp., *Proteus* spp., *Escherichia coli*, or *Enterobacter* spp. Often, these infections present as oral ulcerations. When oral infection develops in such patients, a specimen of exudate should be sent for culture, diagnosis, and antibiotic sensitivity testing. If a bacterial infection is suspected, amoxicillin–clavulanic acid is recommended for non-neutropenic patients. Amoxicillin may be preferable for neutropenic patients because of its wider spectrum of antimicrobial activity. If the clinical course shows little or no improvement in several days, laboratory data should be used to select a more appropriate antimicrobial agent, and referral to a physician should be considered.

Opportunistic infections (bacterial, fungal, and viral) are common in patients with leukemia because (1) malignant leukocytes are immature, (2) chemotherapy induces an immunocompromised state, and (3) use of broad-spectrum antibiotics produces selective antimicrobial killing. A common opportunistic infection is acute pseudomembranous candidiasis. When this complication occurs, the patient should be treated with one of the antifungal medications listed in [Appendix C](#). Infrequently, unusual oral fungal infections (torulopsis, aspergillosis, and mucormycosis) occur, or fungal septicemia may originate from the oral cavity. These patients require potent systemic antifungal agents such as fluconazole, voriconazole, or amphotericin B.

Another common infection in patients receiving chemotherapy is recurrent herpes simplex virus (HSV) infection. Herpetic lesions tend to be larger and take longer to heal than herpetic lesions found in patients without leukemia. Generally, to prevent recurrence, antiviral agents (acyclovir, valacyclovir, famciclovir) are prescribed to HSV antibody–positive patients who are undergoing chemotherapy. In patients in whom HSV infection develops, the diagnosis can be made rapidly using an enzyme-linked immunoassay.⁶⁶ Immunocompromised leukemic patients also are susceptible to varicella-zoster and cytomegalovirus infections, and lesions in the oral cavity attributed to these viruses have been reported.⁶⁷

Bleeding. Small or large areas of submucosal hemorrhage may be found in the patients with leukemia (see

[Fig. 23.2, A](#)). These lesions result from minor trauma (e.g., tongue biting) and are related to thrombocytopenia. Patients with leukemia also may report spontaneous and severe gingival bleeding that is aggravated by poor oral hygiene. Enlarged and boggy gingiva ([Fig. 23.13](#)) bleeds easily, especially if significant thrombocytopenia is present. The dentist should make efforts to improve oral hygiene and should use local measures to control bleeding. A gelatin sponge with thrombin or microfibrillar collagen can be placed over the area, or an oral antifibrinolytic rinse may be used. If local measures fail, medical help will be needed and may involve platelet transfusion.⁶⁸ Platelet counts should be at least 50,000/ μ L before performance of invasive dental procedures. In addition, if patients are skilled at flossing without traumatizing soft tissues, it is reasonable to continue this practice throughout their treatment.⁶⁹

Graft-Versus-Host Disease. Graft-versus-host disease is a common sequela of patients who undergo BMT or stem cell transplantation. It occurs when immunologically active donor T cells react against histocompatibility antigens of the host. The acute stage typically develops within the first 100 days (median, 2–3 weeks) and is marked by rash, mucosal ulcerations, elevated liver enzymes, and diarrhea. The chronic stage occurs at between 3 and 12 months and produces features that mimic Sjögren syndrome and scleroderma, including thickening and lichenoid changes of the skin and mucosa, arthritis, xerostomia, xerophthalmia, mucositis, and dysphagia. Damage to the liver, esophagus (stricture), and immune system may result in recurrent and life-threatening infections. To prevent this complication, patients who are preparing for BMT typically undergo T-cell depletion of the graft and prophylactic treatment with immunosuppressive agents, such as corticosteroids, cyclosporine, methotrexate, or tacrolimus.



FIG 23.13 Leukemic gingival enlargement in a patient who has acute myeloid leukemia. Enlargement is caused by leukemic infiltrations in the gingival tissue. (From Hoffbrand AV, Pettit JE: *Color atlas of clinical hematology*, ed 4, London, 2010, Mosby.)

Adverse Drug Effects. A small number of patients with leukemia describe paresthesias that result from leukemic infiltration of the peripheral nerves or as adverse effects of chemotherapy (vincristine). An adverse effect of cyclosporine use in BMT patients is gingival overgrowth. Pigmentation of the hard palate has been associated with imatinib used for treatment of CML.⁷⁰

Growth and Development. Chemotherapy during childhood can affect growth and development of the teeth and facial bones. This effect is not observed in adults. Restricted growth of the jaws leads to micrognathia, retrognathia, or malocclusion. Damage to the teeth that occurs at the time of chemotherapy can manifest as shortened or blunted roots, dilacerations, calcification abnormalities, pulp enlargement, microdontia, and hypodontia.

Management of Patients in Remission. Patients who have WBC disorders and are in a state of remission can receive most indicated dental treatment (Box 23.2). Patients who have advanced disease and a limited prognosis, as occurs in many cases of leukemia and MM, should receive emergency care only; complex restorative procedures, extensive dental restorations, and other procedures usually are not indicated for these patients.

If invasive (scaling) or surgical procedures are planned for a patient who has a WBC disorder that is considered medically stable, platelet count should be obtained on the day of the procedure. This is done to ensure that an adequate number of platelets are present. The number of platelets can be depressed in these patients by the leukemic process or by agents used to treat the patient. If the platelet count is low, the procedure should be delayed

BOX 23.2 Dental Management of Patients With Leukemia and Lymphoma

P Patient Evaluation and Risk Assessment (see Box 1.1)		C	
<ul style="list-style-type: none"> Evaluate and determine whether leukemia or lymphoma exists. Obtain medical consultation if undiagnosed, poorly controlled, or if uncertain. 		Chair position	For patients with MM who have macroglossia, avoid supine positioning to minimize risk of airway obstruction.
Potential Issues and Factors of Concern		Cardiovascular	Radiation and chemotherapeutic agents can cause cardiac damage to the myocardium, valves, and coronary arteries. They also can be associated with serious cardiac arrhythmias. Consult with patient's physician to determine if there is cardiac damage and take appropriate action to avoid complications.
A		D	
Analgesics	No issues For MM patients with renal dysfunction: (1) use caution with acetaminophen, aspirin, and narcotics and (2) avoid NSAIDs.	Drugs	A few patients on chemotherapy may complain of paresthesias; those receiving cyclosporine (for bone marrow transplantation) may develop gingival hyperplasia. Patients may develop oral pigmentation secondary to drugs used to manage systemic condition.
Antimicrobials	Antibiotic sensitivity testing should be done for oral infections; infections should be treated in a conservative manner with heat, the indicated antibiotic, and strong analgesics for pain. Chlorhexidine rinse may be helpful to promote healing of mucositis. Provide antifungal medications for oral candidiasis. Consult physician regarding need for antibiotics when invasive procedures are planned for patients who have an ANC of <1000 μ L.	Devices	No issues
Anesthesia	Mucositis is painful and requires management with bland mouth rinses, antihistamine solutions, and topical anesthetic gel such as Orabase.	E	
Anxiety	No issues <td>Emergencies</td> <td>For patients with MM, possible airway obstruction secondary to macroglossia may occur.</td>	Emergencies	For patients with MM, possible airway obstruction secondary to macroglossia may occur.
B		F	
Bleeding	If the platelet count is less than 50,000/ μ L, platelet transfusion may be needed before certain invasive and surgical procedures. Confirm by medical consultation.	Follow-up	Follow-up evaluation during hospitalization to ensure oral health and minimize the discomfort of mucositis is recommended. After hospitalization, routine follow-up is recommended pending determination of medical stability in consultation with patient's physician.
Breathing	For patients with MM, assess for macroglossia and risk of airway obstruction.		
Blood pressure	No issues		

ANC, Absolute neutrophil count; MM, multiple myeloma; NSAID, nonsteroidal antiinflammatory drug.

until the patient's physician is consulted. In patients whose disease is stable but who are still thrombocytopenic, platelet replacement by the physician can be instituted if a dental procedure must be done. Dental management of the patient receiving radiation or chemotherapy is discussed further in [Chapter 26](#).

In HL, the spleen may be involved and surgically removed. Subsequently, the patient is at risk for bacterial infection. Risk for such infection is greatest during the first 6 months after splenectomy.⁶⁶ McKenna⁶⁶ suggests that antibiotic prophylaxis should be provided for invasive procedures during the first 6 months after splenectomy. The need for prophylaxis after 6 months has not been defined.^{66,71} The benefit of antibiotic prophylaxis for invasive dental procedures in these patients has not been established.

Up to 80% of patients in whom MM is newly diagnosed present with osteopenia, osteolysis, and pathologic fractures. Patients often are treated with bisphosphonate drugs that inhibit osteoclast activity (see [Chapter 26](#) for in-depth management information regarding management of patients with medication-related osteonecrosis of the jaws^{61,72-74}).

REFERENCES

1. Roit I, Brostoff J, Male D. *Immunology*. Edinburgh: Mosby; 2001.
2. Bagby G. Leukopenia and leukocytosis. In: Goldman L, Ausiello D, eds. *Cecil Medicine*. 23rd ed. Philadelphia, PA: Saunders; 2008:1252-1263.
3. Quesenberry P. Hematopoiesis and hematopoietic growth factors. In: Goldman L, Ausiello D, eds. *Cecil Medicine*. 23rd ed. Philadelphia, PA: Saunders; 2008:1165-1172.
4. Viswanatha D, Larson R. Molecular diagnosis of hematopoietic neoplasms. In: McPherson R, Pincus M, eds. *Henry's Clinical Diagnosis and Management by Laboratory Methods*. 21st ed. Philadelphia, PA: Saunders; 2007.
5. Neville BW. Hematologic disorders. In: Neville BW, Dam DD, Allen CM, et al, eds. *Oral and Maxillofacial Pathology*. 3rd ed. St. Louis: Elsevier Saunders; 2009:571-612.
6. Aster J, et al. Diseases of white blood cells, lymph nodes, spleen and thymus. In: Kumar V, Fausto N, Abbas A. *Robbins and Cotran Pathologic Basis of Disease*. 7th ed. Philadelphia: Elsevier Saunders; 2005.
7. Ferri FF. Leukemia, acute. In: Ferri FF, ed. *Ferri's Clinical Advisor*. Philadelphia, PA: Elsevier (Saunders); 2015:688-701.
8. Ferri FF. Leukemia, chronic. In: Ferri FF, ed. *Ferri's Clinical Advisor*. 13th ed. Philadelphia, PA: Elsevier (Saunders); 2015:694-700.
9. Ferri FF. Lymphoma, non-Hodgkin. In: Ferri FF, ed. *Ferri's Clinical Advisor*. 13th ed. Philadelphia, PA: Elsevier (Saunders); 2015:715-720.
10. Ferri FF. Multiple myeloma. In: Ferri FF, ed. *Ferri's Clinical Advisor*. 13th ed. Philadelphia, PA: Elsevier (Saunders); 2015:783-790.
11. Choi DK, Schmidt ML. Chemotherapy in children with head and neck cancers: perspectives and review of current therapies. *Oral Maxillofac Surg Clin North Am*. 2016;28(1):127-138.
12. Society AC Cancer Facts and Figures 2015: Leukemia, Lymphoma and Myeloma; 2016. Atlanta: American Cancer Society 2015. Accessed 29 January 2016.
13. The Lymphocytic Society; 2015. White Plains, NY: The Leukemia and Lymphoma Society 2015. Accessed 28 January 2016.
14. Appelbaum FR. The acute leukemias. In: Goldman L, Ausiello D, eds. *Cecil Medicine*. 23rd ed. Philadelphia, PA: Saunders; 2008:1390-1396.
15. Fanning S, et al. Acute myelogenous leukemia. In: Carey WD, ed. *Current Clinical Medicine 2009 - Cleveland Clinic*. Philadelphia, PA: Saunders; 2009:610-614.
16. Miller K, Pihan G. Clinical manifestations of acute myeloid leukemia. In: Hoffman R, Furie B, McGlave P, et al. *Hematology: Basic Principles and Practice*. 5th ed. Philadelphia, PA: Churchill Livingstone; 2009: 933-964.
17. The Lymphocytic Society; 2010. White Plains, NY: The Leukemia and Lymphoma Society. Accessed 23 July 2010.
18. Helby J, Bojesen SE, Nielsen SF, et al. IgE and risk of cancer in 37747 individuals from the general population. *Ann Oncol*. 2015;26(8):1784-1790.
19. Society AC Cancer Facts and Figures 2010: Leukemia, Lymphoma and Myeloma; 2010. Atlanta: American Cancer Society. Accessed 23 July 2010.
20. Bejar R, Steensma DP. Recent developments in myelodysplastic syndromes. *Blood*. 2014;124:2793-2803.
21. Wetzler M, Byrd J, Bloomfield C. Acute and chronic myeloid leukemia. In: Kasper D, ed. *Harrison's Principles of Internal Medicine*. 16th ed. New York: McGraw-Hill; 2005.
22. Appelbaum FR. Acute myeloid leukemia in adults. In: Abeloff M, Armitage J, Niederhuber J, et al. *Clinical Oncology*. 3rd ed. Philadelphia: Saunders; 2004.
23. Hoesler D, Gokbuget N. Acute lymphocytic leukemia in adults. In: Hoffman R, Benz E, Shattil S, et al. *Hematology: Basic Principles and Practice*. 5th ed. Philadelphia, PA: Churchill Livingstone; 2009:1033-1050.
24. Dechartres A, Chevret S, Lambert J, et al. Inclusion of patients with acute leukemia in clinical trials: a prospective multicenter survey of 1066 cases. *Ann Oncol*. 2011;22(1):224-233.
25. Rabin K, et al. Clinical manifestations of acute lymphoblastic leukemia. In: Hoffman R, Benz E, Shattil S, et al. *Hematology: Basic Principles and Practice*. 5th ed. Philadelphia, PA: Churchill Livingstone; 2009:1019-1026.
26. O'Mura G. The leukemias. In: Rose L, Kaye D, eds. *Internal Medicine for Dentistry*. 2nd ed. St. Louis: Mosby; 1990.
27. Rowe J, Avivi I. Therapy for acute myeloid leukemia. In: Hoffman R, Benz E, Shattil S, et al. *Hematology: Basic Principles and Practice*. 5th ed. Philadelphia, PA: Churchill Livingstone; 2009:965-989.
28. Wang ES, Berliner N. Clonal disorders of the hematopoietic stem cell. In: Andreoli TE, Carpenter CCJ,

- Griggs RC, et al, eds. *Cecil Essentials of Medicine*. 6th ed. Philadelphia: WB Saunders; 2004.
29. Kinane D. Blood and lymphoreticular disorders. *Periodontology*. 2000;21:84-93.
 30. Pau M, Beham-Schmid C, Zemmann W, et al. Intraoral granulocytic sarcoma: a case report and review of the literature. *J Oral Maxillofac Surg*. 2010;68:2569-2574.
 31. Bhatia R, Radich J. Chronic myeloid leukemia. In: Hoffman R, Benz E, Shattil S, et al. *Hematology: Basic Principles and Practice*. 5th ed. Philadelphia, PA: Churchill Livingstone; 2009:1109-1124.
 32. Kantarjian H, O'Brien S. The chronic leukemias. In: Goldman L, Ausiello D, eds. *Cecil Medicine*. 23rd ed. Philadelphia: Saunders Elsevier; 2008:1397-1407.
 33. Traer E, Deininger MW. How much and how long: tyrosine kinase inhibitor therapy in chronic myeloid leukemia. *Clin Lymphoma Myeloma Leuk*. 2010;10(suppl 1):S20-S26.
 34. Kantarjian H, Shah NP, Hochhaus A, et al. Dasatinib versus imatinib in newly diagnosed chronic-phase chronic myeloid leukemia. *N Engl J Med*. 2010;362(24):2260-2270.
 35. Chesan B. Chronic lymphoid leukemia. In: Abeloff M, Armitage J, Niederhuber J, et al. *Clinical oncology*. 3rd ed. Philadelphia: Saunders; 2004.
 36. Lin T, et al. Chronic lymphocytic leukemia. In: Hoffman R, Benz E, Shattil S, et al. *Hematology: Basic Principles and Practice*. 5th ed. Philadelphia, PA: Churchill Livingstone; 2009:1327-1348.
 37. Zenz T, Frohling S, Mertens D, et al. Moving from prognostic to predictive factors in chronic lymphocytic leukaemia (CLL). *Best Pract Res Clin Haematol*. 2010;23(1):71-84.
 38. Tadmor T, Aviv A, Polliack A. Merkel cell carcinoma, chronic lymphocytic leukemia and other lymphoproliferative disorders: an old bond with possible new viral ties. *Ann Oncol*. 2011;22(2):250-256.
 39. Yee KW, O'Brien SM. Chronic lymphocytic leukemia: diagnosis and treatment. *Mayo Clin Proc*. 2006;81(8):1105-1129.
 40. Tsimberidou AM, Keating MJ. Treatment of patients with fludarabine-refractory chronic lymphocytic leukemia: need for new treatment options. *Leuk Lymphoma*. 2010;51(7):1188-1199.
 41. Connors J. Hodgkin's lymphoma. In: Goldman L, Ausiello D, eds. *Cecil Medicine*. 23rd ed. Philadelphia: Elsevier Saunders; 2008:1420-1425.
 42. Diehl V, et al. Hodgkin lymphoma: clinical manifestations, staging and therapy. In: Hoffman R, Benz E, Shattil S, et al. *Hematology: Basic Principles and Practice*. 5th ed. Philadelphia, PA: Churchill Livingstone; 2009:1239-1264.
 43. Knecht H, Berger C, Rothenberger S, et al. The role of Epstein-Barr virus in neoplastic transformation. *Oncology*. 2001;60(4):289-302.
 44. Keating M. Chronic leukemias. In: Goldman L, Bennett J, eds. *Cecil Medicine*. 21st ed. Philadelphia: Saunders Elsevier; 2000.
 45. Lister T, Coiffier B, Armitage J. Non-Hodgkin's lymphoma. In: Abeloff M, Armitage J, Niederhuber J, et al. *Clinical Oncology*. 3rd ed. Philadelphia: Saunders; 2004.
 46. Cabanillas F. Non-Hodgkin's lymphoma: the old and the new. *Clin Lymphoma Myeloma Leuk*. 2011;11(suppl 1):S87-S90.
 47. Bierman P, et al. Non-Hodgkin's lymphoma. In: Goldman L, Ausiello D, Arend W, et al. *Cecil Medicine*. 23rd ed. Philadelphia: Saunders Elsevier; 2008: 1408-1419.
 48. Gribben J. Clinical manifestations, staging, and treatment of indolent non-Hodgkin lymphoma. In: Hoffman R, Benz E, Shattil S, et al. *Hematology: Basic Principles and Practice*. 5th ed. Philadelphia, PA: Churchill Livingstone; 2009:1281-1292.
 49. Institute USNCC Cancer statistics fact sheets; 2012. United States National Cancer Center 2006. Accessed 20 December 2012.
 50. Dunleavy K, Wilson W. Diagnosis and treatment of non-Hodgkin lymphoma. In: Hoffman R, Benz E, Shattil S, et al. *Hematology: Basic Principles and Practice*. 5th ed. Philadelphia, PA: Churchill Livingstone; 2009:1293-1301.
 51. Silverman S. *Oral Cancer*. 5th ed. Hamilton, Ontario: BC Decker; 2003.
 52. Raut A, Huryn J, Pollack A, et al. Unusual gingival presentation of post-transplantation lymphoproliferative disorder: a case report and review of the literature. *Oral Surg Oral Med Oral Pathol Oral Radiol Endod*. 2000;90(4):436-441.
 53. Burkitt DP. The discovery of Burkitt's lymphoma. *Cancer*. 1983;51(10):1777-1786.
 54. Sandlund J, Link M. Malignant lymphomas in childhood. In: Hoffman R, Benz E, Shattil S, et al. *Hematology: Basic Principles and Practice*. 5th ed. Philadelphia, PA: Churchill Livingstone; 2009:1303-1317.
 55. Kasamon YL, Swinnen LJ. Treatment advances in adult Burkitt lymphoma and leukemia. *Curr Opin Oncol*. 2004;16(5):429-435.
 56. Macfarlane JC, Simpkins MJ. The investigation of a large family affected with Von Willebrand's disease. *Arch Dis Child*. 1954;29(148):483-487.
 57. Tricot G. Multiple myeloma. In: Hoffman R, ed. *Hematology: Basic Principles and Practice*. 5th ed. Philadelphia: Churchill Livingstone, Elsevier; 2009: 1387-1412.
 58. Baz R, Bolwell B. Multiple myeloma. In: Carey WD, ed. *Current Clinical Medicine 2009 - Cleveland Clinic*. Philadelphia: Elsevier Saunders; 2009:647-654.
 59. Rajkumar SV, Kyle RA. Plasma cell disorders. In: Goldman L, Ausiello D, eds. *Cecil Medicine*. 23rd ed. Philadelphia: Elsevier Saunders; 2008:1426-1436.
 60. Storm HH, Klint A, Tryggvadottir L, et al. Trends in the survival of patients diagnosed with malignant neoplasms of lymphoid, haematopoietic, and related tissue in the Nordic countries 1964-2003 followed up to the end of 2006. *Acta Oncol*. 2010;49(5):694-712.
 61. Migliorati CA, Siegel MA, Elting LS. Bisphosphonate-associated osteonecrosis: a long-term complication of bisphosphonate treatment. *Lancet Oncol*. 2006;7:508-514.
 62. Baden LR, et al. Prevention and treatment of cancer-related infections. *JNCCN*. 2012;10: 1412-1445.

63. Scully C, Sonis S, Diz PD. Oral mucositis. *Oral Dis*. 2006;12(3):229-241.
64. McGuire DB, Correa ME, Johnson J, et al. The role of basic oral care and good clinical practice principles in the management of oral mucositis. *Support Care Cancer*. 2006;14:541-547.
65. DeRossie S, et al. Hematologic diseases. In: Greenberg M, Glick M, eds. *Burket's Oral Medicine: Diagnosis and Treatment*. 10th ed. Hamilton, Ontario: Decker, BC; 2003.
66. McKenna S. Immunocompromised host and infection. In: Topazian R, Goldberg M, Hupp J, eds. *Oral and Maxillofacial Infections*. 4th ed. Philadelphia: Saunders; 2002.
67. Sonis S. Oral complications of cancer chemotherapy. In: Peterson D, Sonis S, eds. *Epidemiology, Frequency, Distribution, Mechanisms and Histopathology*. The Hague: Martinus Nijhoff; 1983.
68. Barosi G, Boccadoro M, Cavo M, et al. Management of multiple myeloma and related disorders: Guidelines from the Italian Society of Hematology (SIE), Italian Society of Experimental Hematology (SIES) and Italian Group for Bone Marrow Transplantation (GITMO). *Haematologica*. 2004;89:717-741.
69. Dentistry AAoP. Guideline on dental management of pediatric patients receiving chemotherapy, hematopoietic cell transplantation, and/or radiation. *Pediatr Dent*. 2013;35:E185-E193.
70. Mattsson U, Halbritter S, Mörner Serikoff E, et al. Oral pigmentation in the hard palate associated with imatinib mesylate therapy: a report of three cases. *Oral Surg Oral Med Oral Pathol Oral Radiol Endod*. 2011;111:e12-e16.
71. Scully C, Cawson R. Immunodeficiencies other than HIV/AIDS. In: Scully C, Cawson R, eds. *Medical Problems in Dentistry*. 5 ed. Edinburgh: Elsevier; 2005.
72. Filleul O, Crompton E, Saussez S. Bisphosphonate-induced osteonecrosis of the jaw: a review of 2,400 patient cases. *J Cancer Res Clin Oncol*. 2010;136(8):1117-1124.
73. Lipton A. Bone continuum of cancer. *Am J Clin Oncol*. 2010;33(3 suppl):S1-S7.
74. Walter C, Al-Nawas B, Frickhofen N, et al. Prevalence of bisphosphonate associated osteonecrosis of the jaws in multiple myeloma patients. *Head Face Med*. 2010;6:11.

Acquired Bleeding and Hypercoagulable Disorders

DEFINITION

A number of procedures that are performed in dentistry may cause bleeding. Under normal circumstances, these procedures can be performed with little clinical risk; however, in patients whose ability to control bleeding has been altered by drugs or disease, such procedures may be associated with potentially catastrophic outcomes unless the dental practitioner identifies the problem before initiation of treatment. In most instances, after a patient with a bleeding problem due to drugs or disease has been identified, appropriate dental management will greatly reduce the associated risks. This chapter presents an overview of the physiologic mechanisms involved in the control of bleeding and the pathophysiology of acquired bleeding disorders and hypercoagulable states. Congenital bleeding disorders and genetic hypercoagulable conditions are covered in [Chapter 25](#).

Bleeding disorders are conditions that alter the ability of blood vessels, platelets, and coagulation factors to maintain hemostasis. Acquired bleeding disorders may occur as the result of diseases, drugs, radiation, or chemotherapy for cancer in which vascular wall integrity, platelet production or function, or coagulation factors are impaired.¹

Most bleeding disorders are iatrogenic. Every patient who receives coumarin (brand names: Warfarin, Coumadin) to prevent recurrent thrombosis has a potential bleeding problem. Most of these patients are receiving anticoagulant medication because they have had a recent myocardial infarction, a cerebrovascular accident, or thrombophlebitis. Patients who have atrial fibrillation²⁻⁶; had open heart surgery to correct a congenital defect, replace diseased arteries, or repair or replace damaged heart valves; or had recent total hip or knee replacement also may be receiving long-term anticoagulation therapy. Patients treated with antiplatelet medications to prevent cardiovascular complications also may have a potential bleeding problem.⁷ Advanced age increases the risk for bleeding and bleeding complications.^{8,9} Some people treated with aspirin for chronic illnesses, such as rheumatoid arthritis, may have potential bleeding problems.¹⁰

COMPLICATIONS: Patients who have acquired bleeding disorders and experience trauma or invasive procedures are at risk for excessive bleeding, severe blood loss, and potentially death.

EPIDEMIOLOGY

Patients with acute or chronic leukemia may have clinical bleeding tendencies because of thrombocytopenia, which may result from overgrowth of malignant cells in the bone marrow that leaves no room for red blood cells (RBCs) or platelet precursors.¹¹ In addition, patients with leukemia may develop thrombocytopenia from the toxic effects of the various chemotherapeutic agents used to treat the disease.¹ The etiology and incidence of leukemia are reviewed in [Chapter 23](#).

It is difficult to obtain accurate information about the incidence of other systemic conditions, such as liver disease, renal failure, thrombocytopenia, and drug-induced vascular wall defects, that may render the patient susceptible to prolonged bleeding after injury or surgery. However, when the prevalence of drug-influenced or disease-produced defects in the normal control of blood loss is considered, a busy dental practice will contain a large number of patients who may be potential “bleeders.” It is estimated that in a dental practice of 2000 adults, about 100 to 150 patients may have a possible bleeding problem.

ETIOLOGY

A pathologic alteration of blood vessel walls, a significant reduction in the number of platelets, defective platelets or platelet function, a deficiency of one or more coagulation factors, the administration of anticoagulant or antiplatelet drugs, a disorder of platelet release, or the inability to destroy free plasmin can result in significant abnormal clinical bleeding. This may occur even after minor injuries and may lead to death in some patients if immediate action is not taken.

The classification given in [Box 24.1](#) is based on bleeding problems in patients with normal numbers of platelets (nonthrombocytopenic purpura), decreased numbers of platelets (thrombocytopenic purpura), disorders of coagulation, and hypercoagulable states.

Infections, chemicals, collagen disorders, or certain types of allergies can alter the structure and function of the vascular wall to the point that the patient may have a clinical bleeding problem. A patient may have normal numbers of platelets, but they may be defective or unable to perform their proper function in the control of blood loss from damaged tissues. If the total number of circulating platelets is reduced to below 50,000/ μ L of

BOX 24.1 Classification of Acquired Bleeding and Thrombotic Disorders

Nonthrombocytopenic Purpuras**Vascular Wall Alteration**

Scurvy
Infections
Chemicals
Allergy

Disorders of Platelet Function

Drugs
Aspirin, other NSAIDs
Other antiplatelet drugs
Dipyridamole and aspirin (Aggrenox)
Ticlopidine (Ticlid)
Clopidogrel (Plavix)
Abciximab (ReoPro)
Eptifibatid (Integrilin)
Tirofiban (Aggrastat)
Alcohol
 β -Lactam antibiotics
Cephalothins
Herbal medications
Vitamin E allergy
Autoimmune disease
Uremia

Thrombocytopenic Purpuras**Primary**

Idiopathic

Secondary

Chemicals
Physical agents (radiation)
Systemic disease (leukemia and others)
Metastatic cancer to bone
Splénomegaly
Drugs
Alcohol
Thiazide diuretics
Estrogens
Gold salts
Vasculitis
Mechanical prosthetic heart valves
Viral or bacterial infections

Disorders of Coagulation

Liver disease
Vitamin K deficiency
Biliary tract obstruction
Malabsorption
Excessive use of broad-spectrum antibiotics
Anticoagulation drugs
Heparin
Low-molecular-weight heparins

- Enoxaparin (Lovenox)
- Ardeparin (Normiflo)
- Dalteparin (Fragmin)
- Nadroparin (Fraxiparine)
- Reviparin (Clivarine)
- Tinzaparin (Innohep)

Synthetic heparin
Fondaparinux (Arixtra)
Idraparinux
Coumarin (warfarin), oral
Direct thrombin inhibitors
Lepirudin (Reflucan)
Desirudin (Revasc)
Argatroban (Acova)
Bivalirudin (Angiox)
Dabigatran (Pradaxa), oral
Disseminated intravascular coagulation
Primary fibrinogenolysis

Hypercoagulable States

Old age
Immobilization
Obesity
Infection
Hospitalization
Major surgery
Hormonal therapy
Atherosclerosis
Malignancy
Hyperhomocysteinemia
Antiphospholipid antibody syndromes
Lupus erythematosus
Rheumatoid arthritis
Sjögren syndrome

NSAID, Nonsteroidal antiinflammatory drug.

blood, the patient may be a bleeder. In some cases, the total platelet count is reduced by unknown mechanisms; this is called *primary* or *idiopathic thrombocytopenia*. Chemicals, radiation, and various systemic diseases (e.g., leukemia) may have a direct effect on the bone marrow, potentially resulting in secondary thrombocytopenia.^{12,13}

Acquired coagulation disorders are the most common cause of prolonged bleeding. Liver disease and disseminated intravascular coagulation (DIC) can lead to severe bleeding problems. Many of the other acquired coagulation disorders may become apparent in patients only after trauma or surgical procedures. In contrast with the congenital

coagulation disorders, in which only one factor is affected, the acquired coagulation disorders usually have multiple factor deficiencies.¹⁴⁻¹⁷

Acquired hemophilia is an uncommon finding that can be caused by autoantibody inhibitors directed against “self”-clotting, which is mostly commonly factor VIII.¹⁸⁻²⁴ About half of cases of acquired hemophilia are associated with autoimmune diseases, lymphoproliferative disorders, idiosyncratic drug reactions, pregnancy, and advanced age.²⁴

The liver produces all of the protein coagulation factors; thus, any patient with significant liver disease may have

a bleeding problem. In addition to having a possible disorder in coagulation, a patient with liver disease who develops portal hypertension and hypersplenism may be thrombocytopenic as a result of splenic overactivity, which leads to increased sequestration of platelets in the spleen.²⁵

Any condition that so disrupts the intestinal flora that vitamin K is not produced in sufficient amounts will result in a decreased plasma level of the vitamin K–dependent coagulation factors. Vitamin K is needed by the liver to produce prothrombin (factor II) and factors VII, IX, and X. Biliary tract obstruction, malabsorption syndrome, and excessive use of broad-spectrum antibiotics all can lead to low levels of prothrombin and factors VII, IX, and X on this basis.²⁵

Drugs, such as heparin and coumarin derivatives, can cause a bleeding disorder because they may disrupt the coagulation process. Antiplatelet medications, aspirin, other nonsteroidal antiinflammatory drugs (NSAIDs), penicillin, cephalosporins, and alcohol also may interfere with platelet function.²⁶

Many herbal supplements can impair hemostatic function for the control of bleeding. Fish oil or concentrated omega-3 fatty acid supplements may impair platelet activation. Diets naturally rich in omega-3 fatty acids can result in a prolonged bleeding time and abnormal platelet aggregation.²⁷ Fish oil supplements prolong bleeding time, inhibit platelet aggregation, and decrease thromboxane A₂ (TXA₂) production.²⁸ Vitamin E appears to inhibit protein kinase C–mediated platelet aggregation and nitric oxide production.¹⁵ The following herbal supplements have potential antiplatelet activity: ginkgo, garlic, bilberry, ginger, dong quai, Asian ginseng, tumeric, meadow sweet, willow, coumarin-containing herbs, chamomile, horse chestnut, red clover, and fenugreek. In patients with unexplained bruising or bleeding, it is prudent to review any new medications or supplements and discontinue those that may be associated with bleeding.¹⁵

Pathophysiology

The three phases of hemostasis for controlling bleeding are vascular, platelet, and coagulation. The vascular and platelet phases are referred to as primary, and the coagulation phase is secondary. The coagulation phase is followed by the fibrinolytic phase, during which the clot is dissolved (Box 24.2).

Vascular Phase. The vascular phase begins immediately after injury and involves vasoconstriction of arteries and veins in the area of injury, retraction of arteries that have been cut, and buildup of extravascular pressure by blood loss from cut vessels. This pressure aids in collapsing the adjacent capillaries and veins in the area of injury. Vascular wall integrity is important for maintaining the fluidity of blood. The smooth endothelial lining consists of a nonwettable surface that, under normal conditions, does not activate platelet adhesion or coagulation. In fact, the endothelial cells synthesize and secrete three potent

BOX 24.2 Normal Control of Bleeding

1. Vascular phase
 - a. Vasoconstriction occurs in area of injury.
 - b. Begins immediately after injury.
2. Platelet phase
 - a. Platelets and vessel wall become “sticky.”
 - b. Mechanical plug of platelets seals off openings of cut vessels.
 - c. Begins seconds after injury.
3. Coagulation phase
 - a. Blood lost into surrounding area coagulates through extrinsic and common pathways.
 - b. Blood in vessels in area of injury coagulates through intrinsic and common pathways.
 - c. Takes place more slowly than other phases.
4. Fibrinolytic phase
 - a. Release of antithrombotic agents
 - b. Destruction of antithrombotic agents by spleen and liver

antiplatelet agents: prostacyclin, nitric oxide, and certain adenine nucleotides.^{26,29}

Vascular endothelial cells also are involved in antithrombotic and prothrombotic activities. The major antithrombotic activity consists of secretion of heparin-like glycosaminoglycans (heparin sulfate) that catalyze inactivation of serine proteases such as thrombin and factor Xa by antithrombin III. Endothelial cells also produce thrombomodulin, which combines with thrombin to form a complex that activates protein C. Activated protein C (APC) then binds to endothelially released protein S, causing proteolysis of factor Va and factor VIIIa that inhibits coagulation. Tissue-type plasminogen activator (tPA) is released by injured endothelial cells to initiate fibrinolysis.^{16,30-32}

Vessel wall components contribute prothrombotic activities. Exposure of vessel wall subendothelial tissues, collagen, and basement membrane through chemical or traumatic injury serves as a tissue factor (TF)—for which the old term was *tissue thromboplastin*—and initiates coagulation by way of the extrinsic pathway. The extrinsic pathway can be turned off by tissue factor pathway inhibitor (TFPI). An inducible endothelial cell prothrombin activator may directly generate thrombin. Injured endothelial cells release adenosine diphosphate (ADP), which induces platelet adhesion. Vessel wall injury also promotes platelet adhesion and thrombus formation through exposure of subendothelial tissues to von Willebrand factor (vWF). Endothelial cells also contribute to normal homeostasis and vascular integrity through synthesis of type IV collagen, fibronectin, and vWF.^{16,30-32}

Platelet Phase. Platelets are cellular fragments from the cytoplasm of megakaryocytes that last 8 to 12 days in the circulation. About 30% of platelets are sequestered in the microvasculature or spleen and serve as a functional reserve. Platelets do not have a nucleus; thus, they are unable to repair inhibited enzyme systems through drugs

such as aspirin. Aged or nonviable platelets are removed and destroyed by the spleen and liver.^{16,30,33} Functions of platelets include maintenance of vascular integrity, formation of a platelet plug to aid in initial control of bleeding, and stabilization of the platelet plug through involvement in the coagulation process. About 10% of platelets are used to nurture endothelial cells, allowing for endothelial and smooth muscle regeneration.

Subendothelial tissues are exposed at the site of injury and, through contact activation, cause the platelets to become sticky and adhere to subendothelial tissues; platelet membrane glycoprotein Ib (GPIb) binds with vWF, which is attached to the subendothelial tissue; and glycoprotein Ia/IIa (GPIa/IIa) and glycoprotein VI (GPVI) bind to collagen in the injured vessel wall.

Adenosine diphosphate released by damaged endothelial cells initiates aggregation of platelets (primary wave), and when platelets release their secretions, a second wave of aggregation results. Platelets bind with fibrinogen by the membrane glycoprotein IIb (GPIIb); the fibrinogen is then converted to fibrin, which stabilizes the platelet plug. The result of the preceding processes is a clot of platelets and fibrin attached to the subendothelial tissue. **Box 24.3** summarizes the functions of platelets.

A product of platelets, thromboxane, is needed to induce platelet aggregation. The enzyme cyclooxygenase (COX) is essential in the process for generation of thromboxane. Endothelial cells, through a similar process (also dependent on COX), generate prostacyclin, which inhibits platelet aggregation. Aspirin acts as an inhibitor of COX, and this causes irreversible damage to the platelets. However, endothelial cells can, after a short period, recover and synthesize COX; thus, aspirin has only a short effect on the availability of prostacyclin from these cells. The net result of aspirin therapy is to inhibit platelet aggregation. This effect can last up to 9 days (the time needed for all old platelets to be cleared from the blood).

Coagulation Phase. The process of the fibrin-forming (coagulation) system is shown in **Fig. 24.1**. The overall time involved from injury to a fibrin-stabilized clot is about 9 to 18 minutes. Platelets, blood proteins, lipids, and ions are involved in the process. Thrombin is generated on the surface of the platelets, and bound fibrinogen is converted to fibrin.^{16,33} The end product of coagulation is a fibrin clot that can stop further blood loss from injured tissues (**Figs. 24.2** and **24.3**).

Coagulation of blood involves the components shown in **Table 24.1**. Many of the coagulation factors are proenzymes that become activated in a “waterfall” or cascade manner—that is, one factor becomes activated, and it in turn activates another, and so on in an ordered sequence.³⁴ For example, the proenzyme (zymogen) factor XI is activated to the enzyme factor XIa through contact with injury-exposed subendothelial tissues *in vivo* to start the intrinsic pathway. *In vitro*, the intrinsic pathway is initiated by contact activation of factor XII. Coagulation

BOX 24.3 Platelet Functions and Activation

1. Plasma membrane receptors
 - a. Glycoprotein Ib reacts with von Willebrand factor, which attaches to subendothelial tissue.
 - b. Glycoprotein Ia/IIa binds to collagen in the injured vessel wall.
 - c. Glycoprotein VI binds to collagen in the injured vessel wall.
 - d. Glycoproteins IIb and IIIa attach to fibrinogen or fibronectin.
2. Platelets contain three types of secretory granules:
 - a. Lysosomes
 - b. Alpha granules—contain platelet factor 4; β -thromboglobulin; and several growth factors, including platelet-derived growth factor (PDGF), endothelial cell growth factor (PD-ECGF), and transforming growth factor- β (TGF- β); also several hemostatic proteins: fibrinogen, factor V, and von Willebrand factor
 - c. Dense bodies (electron-dense organelles)—contain ATP, ADP, calcium, and serotonin
3. Platelets provide a surface for activation of soluble coagulation factors:
 - a. Activated platelets expose specific receptors that bind factors Xa and Va, thus increasing their local concentration, thereby accelerating prothrombin activation.
 - b. Factor X also is activated by factors IXa and VIII on the surface of the platelet.
4. Platelets contain a membrane phospholipase C:
 - a. When activated, it forms diglyceride.
 - b. Diglyceride is converted to arachidonic acid by diglyceride lipase.
 - c. Arachidonic acid is a substrate for prostaglandin synthetase (COX).
 - d. COX formation is inhibited by aspirin and NSAIDs.
 - e. The prostaglandin endoperoxide PGG₂ is required for ADP-induced aggregation and release, as is thromboxane A₂. The formation of both of these agents is dependent on COX.
5. The functions of platelets include:
 - a. Nurturing endothelial cells
 - b. Endothelial and smooth muscle regeneration
 - c. Formation of a platelet plug for initial control of bleeding
 - d. Stabilization of the platelet plug

ADP, Adenosine diphosphate; ATP, adenosine triphosphate; COX, cyclooxygenase; NSAID, nonsteroidal antiinflammatory drug. Data from McMillan R: Hemorrhagic disorders: abnormalities of platelet and vascular function. In Goldman L, Ausiello D, editors: *Cecil medicine*, ed 23, Philadelphia, 2008, Saunders and Baz R, Mekhail T: Disorders of platelet function and number. In Carey WD, et al, editors: *Current clinical medicine 2009—Cleveland Clinic*, Philadelphia, 2009, Saunders.

proceeds through two pathways—the intrinsic and the extrinsic. Both use a common pathway to form the end product, fibrin.^{16,33} **Fig. 24.1** shows these coagulation pathways.

The (faster) extrinsic pathway is initiated through TF (an integral membrane protein) and is released or exposed through injury to tissues; this process activates factor VII (VIIa). In the past, the trigger for initiating the extrinsic

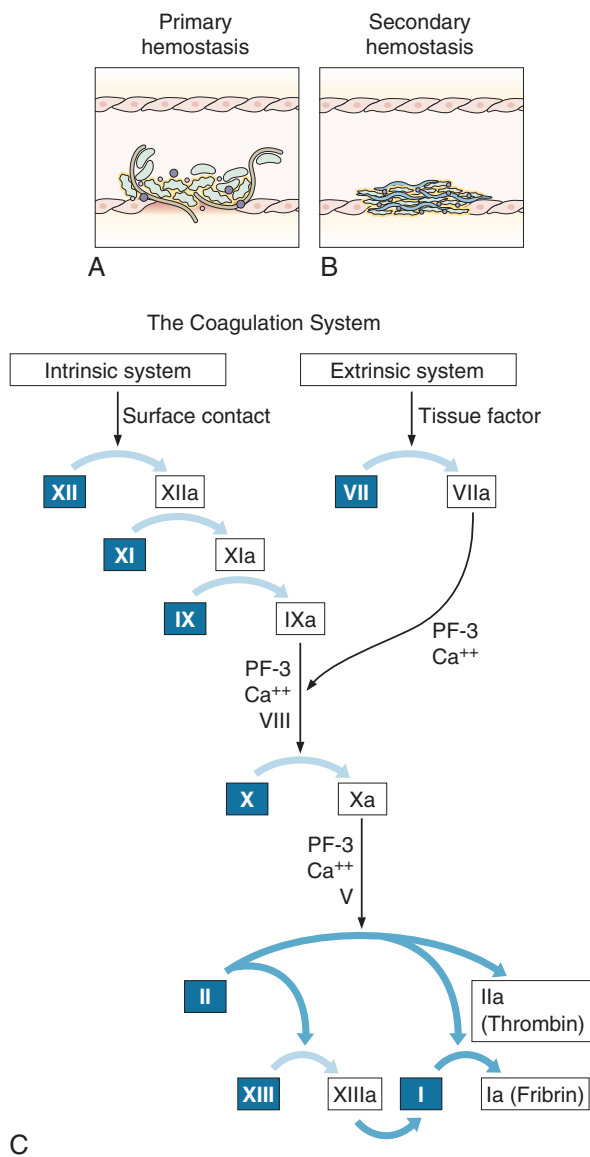

FIG 24.1 The primary (vascular and platelet) system (A), the secondary (coagulation) system for the control of bleeding (B), and the coagulation cascade (C). The intrinsic coagulation system is triggered by surface contact, the extrinsic system by release of tissue factor from injured tissues, and the common pathway by factor X. (From Ragni MV: The hemophilias: factor VIII and factor IX deficiencies. In Young NS, Gerson SL, High KA, editors: *Clinical hematology*, St. Louis, 2006, Mosby.)

pathway was referred to as a tissue *thromboplastin*. It has since been shown that the real activator is the TF. The term *extrinsic pathway* continues to be used today even though it is somewhat outdated. This is because TF is not always extrinsic to the circulatory system but is expressed on the surface of vascular endothelial cells and leukocytes.^{16,33}

Thrombin generated by the faster extrinsic and common pathway is used to accelerate the slower intrinsic and common pathway. Activation of factor XII acts as a

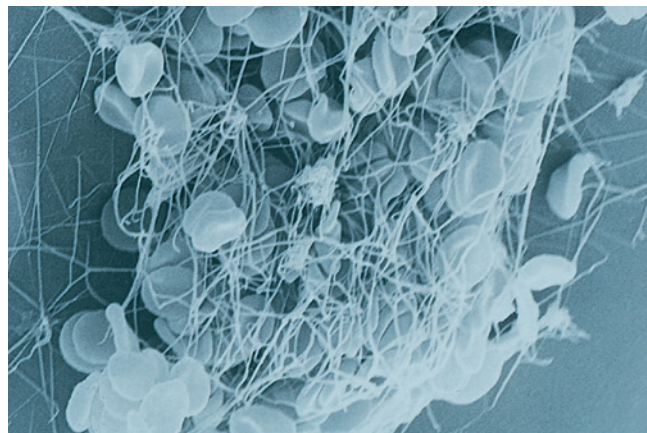

FIG 24.2 A blood clot or thrombus, showing blood cells trapped by fibrin strands (scanning electron microscope photograph). (From Stevens ML: *Fundamentals of Clinical Hematology*, Philadelphia, WB Saunders, 1997.)

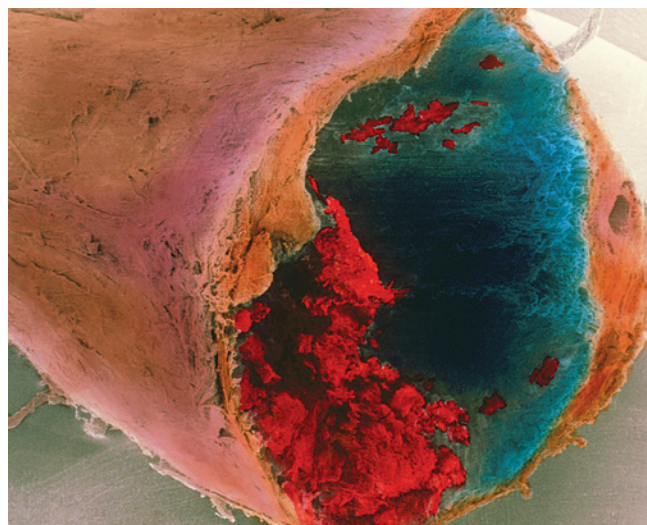

FIG 24.3 A colored scanning electron microscope photograph of a blood clot or thrombus inside the coronary artery of a human heart. (Reprinted with permission of P. M. Motta, G. Macchiarelli, S. A. Nottola/Photo Researchers, Inc.)

common link between the component parts of the homeostatic mechanism: coagulation, fibrinolytic, kinin, and complement systems. As a result, thrombin is generated; in turn, fibrinogen is converted to fibrin, activates factor XIII, enhances factor V and factor VIII activity, and stimulates aggregation of additional platelets.^{16,33}

Fibrinolytic Phase. The fibrin-lysing (fibrinolytic) system is needed to prevent coagulation of intravascular blood away from the site of injury and to dissolve the clot after it has served its function in homeostasis (Fig. 24.4). This system involves plasminogen, a proenzyme for the enzyme plasmin, which is produced in the liver, and various

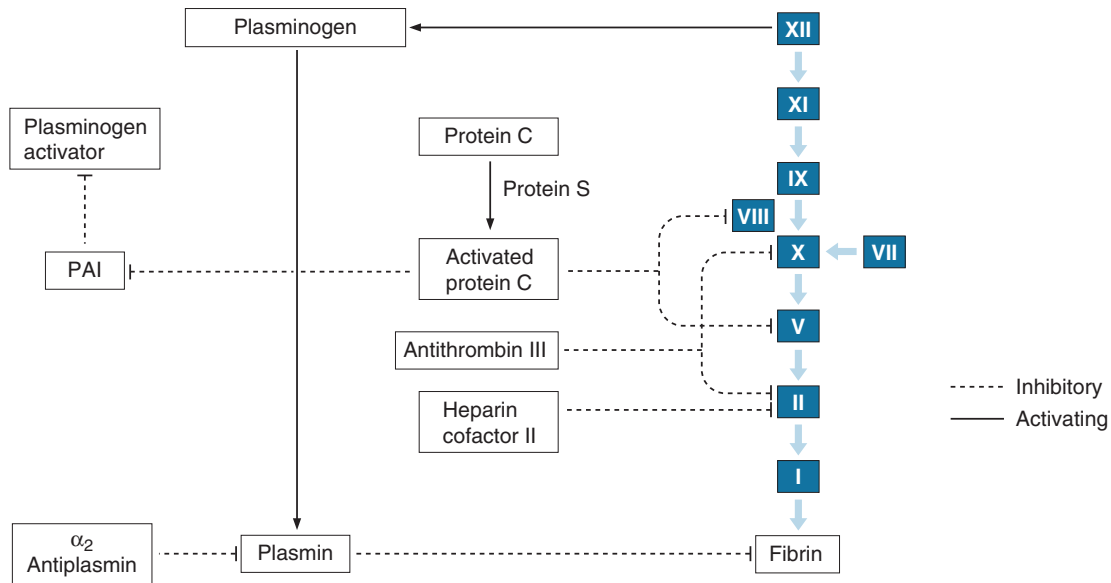

FIG 24.4 The coagulation and fibrinolytic pathways with inhibitors. *PAI-1*, Plasminogen activator inhibitor-1. (From Bontempo FA: Hematologic abnormalities in liver disease. In Young NS, Gerson SL, High KA, editors: *Clinical hematology*, St. Louis, 2006, Mosby.)

TABLE 24.1 Blood Coagulation Components

Factor	Deficiency	Function
Factor II (prothrombin)	Acquired—common	Protease zymogen
Factor X	Acquired—common	Protease zymogen
Factor IX	Acquired—common	Protease zymogen
Factor VII	Acquired—common	Protease zymogen
Factor VIII	Acquired—rare	Cofactor
Factor V	Acquired—rare	Cofactor
Factor XI	Acquired—common	Protease zymogen
Factor I (fibrinogen)	Acquired—common	Structural
von Willebrand Factor	Acquired—rare	Adhesion

From McVey JH: Coagulation factors. In Young NS, Gerson SL, High KA, editors: *Clinical hematology*, St. Louis, 2006, Elsevier.

plasminogen activators and inhibitors of plasmin. The prime endogenous plasminogen activator is tPA, which is released by endothelial cells at the site of injury.

The tPA released by injured endothelial cells binds to fibrin as it activates the conversion of fibrin-bound plasminogen to plasmin. Circulating plasminogen (i.e., not fibrin bound) is not activated by tPA. Thus, tPA is efficient in dissolving a clot without causing systemic fibrinolysis.^{16,34,35}

The effect of plasmin on fibrin and fibrinogen is to split off large pieces that are broken up into smaller and smaller segments. The final smaller pieces are called *split products*. These split products also are referred to as *fibrin degradation products* (FDPs). FDPs increase vascular permeability and interfere with thrombin-induced fibrin formation; this can provide the basis for clinical bleeding problems.^{16,36} **Box 24.4** summarizes the fibrin-lysing system.

BOX 24.4 Fibrin-Lysing (Fibrinolytic) System

1. Activation of coagulation also activates fibrinolysis.
2. Active enzyme: plasmin
3. Plasminogen activated to plasmin
 - a. Tissue-type plasminogen activator (t-PA)
 - b. Prourokinase (scu-PA)
 - c. Urokinase (u-PA), streptokinase
4. t-PA
 - a. t-PA is produced by endothelial cells.
 - b. It is released by injury.
 - c. It activates plasminogen bound to fibrin.
 - d. Circulating plasminogen is not activated.
 - e. t-PA will dissolve clot, not cause systemic fibrinolysis.
5. Action of plasmin:
 - a. Plasmin splits large pieces of alpha and beta polypeptides from fibrin.
 - b. It splits small pieces of gamma chains.
 - c. First product is X monomer.
 - d. Each X monomer splits into one E fragment and two D fragments.
 - e. Split products are called fibrin split products (FSPs) and fibrin degradation products (FDPs).
6. Action of fibrin degradation products:
 - a. Increase vascular permeability
 - b. Interfere with thrombin-induced fibrin formation

Data from Lijnen HR, Collen D: Molecular and cellular basis of fibrinolysis. In Hoffman R, et al, editors: *Hematology: basic principles and practice*, Philadelphia, 2009, Churchill Livingstone and Kessler CM: Hemorrhagic disorders: coagulation factor deficiencies. In Goldman L, Ausiello D, editors: *Cecil textbook of medicine*, ed 23, Philadelphia, 2008, Saunders.

BOX 24.5 Physiologic Antithrombotic Systems

1. Normal endothelium promotes blood fluidity by inhibiting platelet activation.
2. Endothelium also plays a role in anticoagulation by preventing fibrin formation.
3. Antithrombin III
 - a. It is the major protease inhibitor of the coagulation system.
 - b. It inactivates thrombin and other activated coagulation factors.
 - c. Heparin acts as an anticoagulant by binding to antithrombin and greatly accelerates the ability of antithrombin to inhibit coagulation proteases.
 - d. Heparin and heparin sulfate proteoglycans are naturally present on endothelial cells.
4. Activated protein C, with its cofactor protein S, acts as a natural anticoagulant by destroying factors Va and VIIIa.
5. Tissue factor pathway inhibitor (TFPI), a plasma protease inhibitor, inhibits factor VIIa and the extrinsic pathway.
6. The endogenous fibrinolytic system degrades any fibrin produced despite the above-mentioned antithrombotic mechanisms.
7. Inherited deficiencies of antithrombin, protein C, or protein S are associated with a lifelong thrombotic tendency.
8. TFPI deficiency has yet to be related to clinical problems.

Data from Dahlback B, Stenflo J: Regulatory mechanisms in hemostasis: natural anticoagulants. In Hoffman R, et al, editors: *Hematology: basic principles and practice*, ed 5, Philadelphia, 2009, Churchill Livingstone.

Antiplasmin factors present in circulating blood rapidly destroy free plasmin but are relatively ineffective against plasmin that is bound to fibrin (Box 24.5). Free plasmin is rapidly destroyed and does not interfere with the formation of a clot. Bound plasmin is not inactivated, and it is free to dispose of the fibrin clot after its function in homeostasis has been fulfilled. In a sense, the clot is “programmed” at the time of its formation to self-destruct.^{16,36}

Timing of Clinical Bleeding. A significant disorder that may occur in the vascular or platelet phase leads to an immediate clinical bleeding problem after injury or surgery. These phases are concerned with controlling blood loss immediately after an injury and, if defective, will lead to an early problem. However, if the vascular and platelet phases are normal and the coagulation phase is abnormal, the bleeding problem will not be detected until several hours or longer after the injury or surgical procedure. In the case of small cuts, for example, little bleeding would occur until several hours after the injury, and then a slow trickle of bleeding would start. If the coagulation defect were severe, this slow loss of blood could continue for days. Even with this “trivial” rate, a significant loss of blood might occur (0.5 mL/min or about 3 U/day).¹⁷



FIG 24.5 Jaundice of the skin in a patient with chronic liver disease.

CLINICAL PRESENTATION

Signs and Symptoms

Signs associated with bleeding disorders may appear in the skin or mucous membranes or after trauma or invasive procedures. Jaundice (Fig. 24.5), spider angiomas (Fig. 24.6), and ecchymoses (Fig. 24.7) may be seen in individuals with liver disease. A fine tremor of the hands when held out also may be observed in these patients. In about 50% of persons with liver disease, a reduction in platelets occurs because of hypersplenism that results from the effects of portal hypertension; these patients may show petechiae on the skin and mucosa.^{16,17,26,35}

Petechiae (Fig. 24.8) and ecchymoses are the signs seen most commonly in patients with abnormal platelets or thrombocytopenia.³⁷

Patients with acute or chronic leukemia may reveal one or more of the following signs: ulceration of the oral mucosa, hyperplasia of the gingivae (Fig. 24.9), petechiae of the skin or mucous membranes (Fig. 24.10), ecchymoses of skin or mucous membranes, and lymphadenopathy. Chapter 23 discusses these findings in greater detail.

A number of patients with bleeding disorders may show no objective signs that suggest the underlying problem. Severe or chronic bleeding can lead to anemia with features of pallor, fatigue, and so forth. Anemia is discussed in detail in Chapter 22.

Laboratory and Diagnostic Findings

Several tests are available to screen patients for bleeding disorders and to help pinpoint the specific deficiency. In

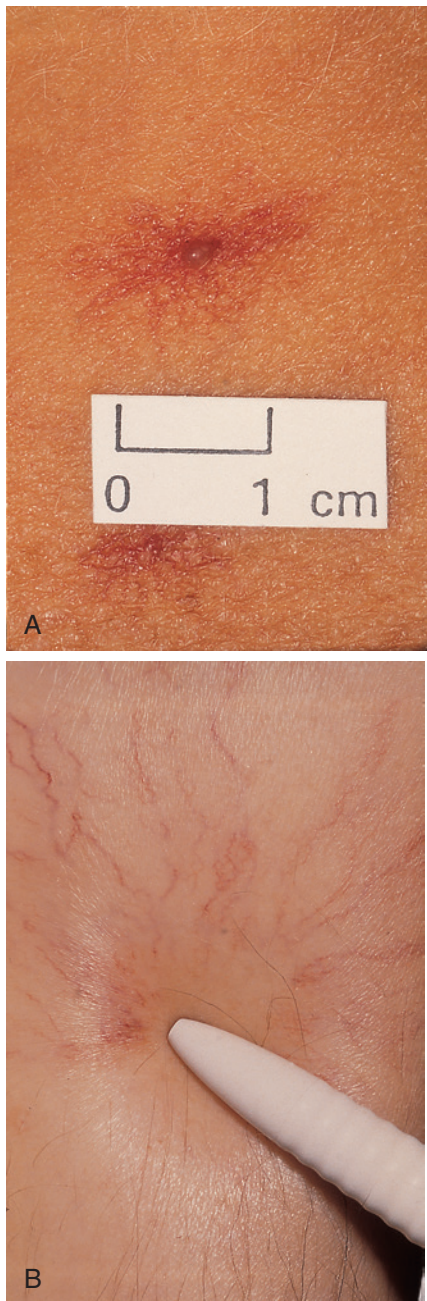

FIG 24.6 **A**, Spider angioma on the skin of a patient with chronic liver disease. **B**, Note how the spider legs of the angioma blanch with pressure on the central arteriole. (From Forbes CD, Jackson WF: *Color atlas and text of clinical medicine*, ed 3, Edinburgh, 2003, Mosby.)



FIG 24.7 Ecchymoses on the mucosa of the hard and soft palate in a patient with chronic liver disease.



FIG 24.8 The arm of a patient with thrombocytopenia showing numerous petechiae.



FIG 24.9 Hyperplastic gingiva in a patient with leukemia.

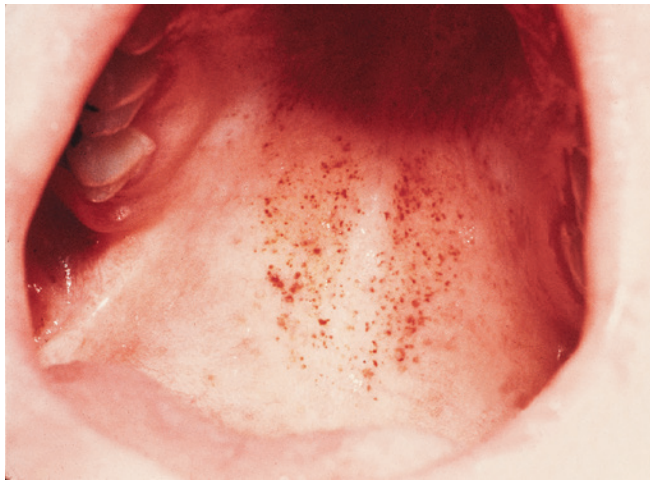

FIG 24.10 Palatal petechiae in a patient with leukemia. (From Hoffbrand AV: *Color atlas of clinical hematology*, ed 3, St. Louis, 2000, Mosby.)

general, screening is done in dentistry when the patient reveals a history of a bleeding problem or a family member with a history of a bleeding problem or when signs of bleeding disorders are found during the clinical examination. The dentist can order the screening tests, or the patient can be referred to a hematologist for screening. In medicine, routine screening is done for patients before major surgical procedures such as open heart surgery are performed.

The Ivy bleeding time (BT) has been used to screen for disorders of platelet function and thrombocytopenia. It has been found to be unreliable and is no longer used as a screening test. The platelet function analyzer (PFA-100), an instrument that measures platelet-dependent coagulation under flow conditions, is more sensitive and specific for platelet disorders and von Willebrand disease than the bleeding time; however, it is not sensitive enough to rule out underlying mild bleeding disorders. The relationship between bleeding time test and postextraction bleeding in a healthy control population was evaluated by Brennan et al in 2002.³⁸ The mean cutaneous BT was 5.9 minutes (range, 1.5–10.0 minutes). The mean oral BT was 7.5 minutes (range, 0–20 minutes). Cutaneous BT did not correlate with oral BT or any measures of postoperative bleeding.³⁸ Therefore, the BT and PFA-100 are not recommended as screening tests to be used by dentists.

Three tests are recommended for use in initial screening for possible bleeding disorders:^{15,30,39} activated partial thromboplastin time (aPTT), prothrombin time (PT), and platelet count (Fig. 24.11). In the absence of clues to the cause of the bleeding problem, if the dentist is ordering the tests through a commercial laboratory, an additional test can be added to the initial screen: the thrombin time (TT).^{15,30,39}

Patients with positive screening test results should be evaluated further so the specific deficiency can be identified

and the presence of inhibitors ruled out. A hematologist orders these tests, establishes a diagnosis that is based on the additional testing, and makes recommendations for treatment of the patient who is found to have a significant bleeding problem.

Screening Tests. Partial Thromboplastin Time. The partial thromboplastin time (PTT) is used to check the intrinsic system (factors VIII, IX, XI, and XII) and the common pathways (factors V and X, prothrombin, and fibrinogen). It also is the best single screening test for coagulation disorders. A phospholipid platelet substitute is added to the patient's blood to initiate the coagulation process via the intrinsic pathway. When a contact activator, such as kaolin, is added, the test is referred to as *activated PTT* (aPTT). A control sample must be run with the test sample. In general, aPTT ranges from 25 to 35 seconds, and results in excess of 35 seconds are considered abnormal or prolonged. The aPTT is prolonged in cases of mild to severe deficiency of factor VIII or IX. The test result is abnormal when a given factor is 15% to 30% below its normal value.^{15,30,39,40}

Prothrombin Time. The PT is used to check the extrinsic pathway (factor VII) and the common pathway (factors V and X, prothrombin, and fibrinogen). For this test, tissue thromboplastin is added to the test sample to serve as the activating agent. Again, a control must be run, and results vary from one laboratory to another. In general, the normal range is 11 to 15 seconds. PT is prolonged when the plasma level of any factor is below 10% of its normal value. When the test is used to evaluate the level of anticoagulation with coumarin-like drugs the international normalized ratio (INR) format is recommended. INR, a method that standardizes PT assays, is defined later in this chapter.^{15,30,39,40} In this book, the term *INR* is used only for PT tests from patients taking coumarin-like drugs.⁴¹

Platelet Count. The platelet count is used to screen for possible bleeding problems caused by thrombocytopenia. A normal platelet count is 150,000 to 450,000/ μL of blood. Patients with a platelet count of between 50,000 and 100,000/ μL manifest excessive bleeding only with severe trauma. Patients with counts below 50,000/ μL demonstrate skin and mucosal purpura and bleed excessively with minor trauma. Patients with platelet counts below 20,000/ μL may experience spontaneous bleeding.^{15,30,39,41}

Thrombin Time. In this test, thrombin is added to the patient's blood sample as the activating agent. It converts fibrinogen in the blood to insoluble fibrin, which makes up the essential portion of a blood clot. Again, a control must be run, and results vary from laboratory to laboratory. This test bypasses the intrinsic, extrinsic, and most of the common pathway. For example, patients with hemophilia A or factor V deficiency have a normal TT. Generally, the normal range for the TT test is 9 to 13 seconds, and results in excess of 16 to 18 seconds are considered abnormal or prolonged.^{39,40} Abnormal test

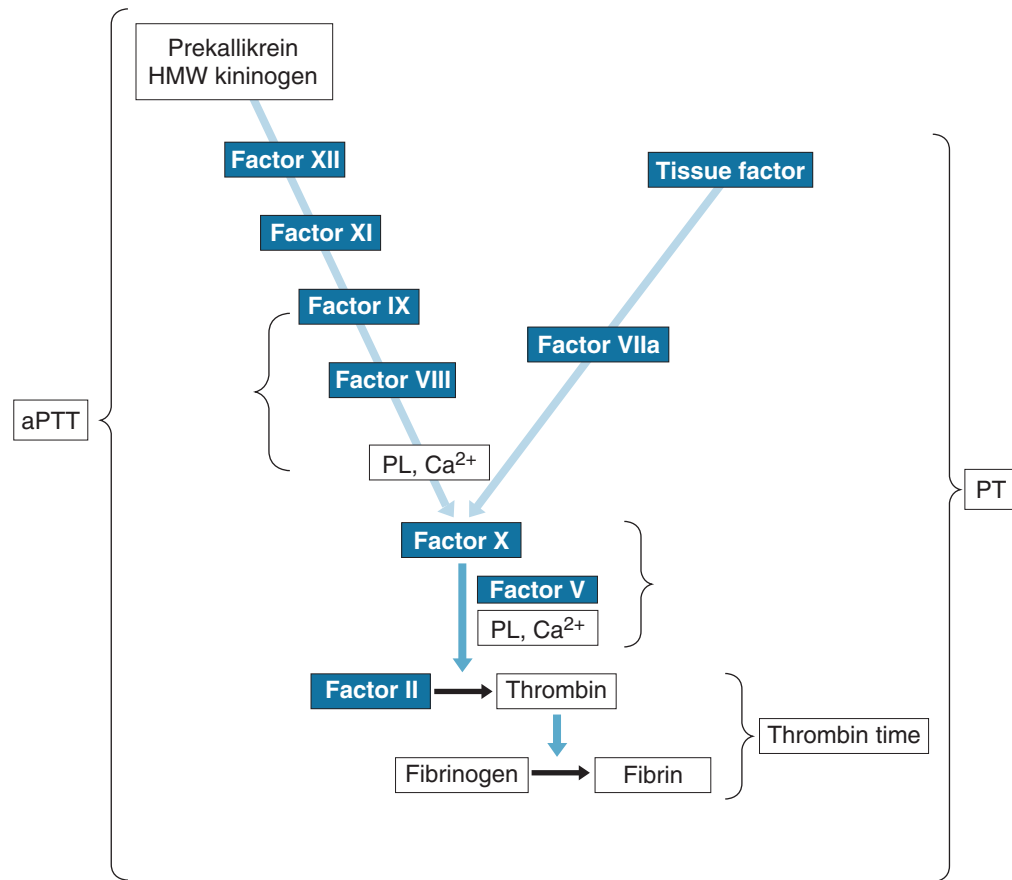

FIG 24.11 Coagulation cascade indicating the intrinsic pathway measured by activated partial thromboplastin time (aPTT); the extrinsic pathway measured by prothrombin time (PT); and the conversion of fibrinogen to fibrin, which is measured by thrombin time (TT). Other proteins—prekallikrein and high-molecular-weight (HMW) kininogen—participate in the contact activation phase but are not considered coagulation factors. Ca^{2+} , Calcium; *PL*, phospholipid. (From Rick ME: Coagulation testing. In Young NS, Gerson SL, High KA, editors: *Clinical hematology*, St. Louis, 2006, Mosby.)

results usually are caused by excessive plasmin or fibrin split products.

Diagnostic Tests Performed by the Hematologist. When one or more of the screening tests yield an abnormal result, the hematologist runs additional tests to pinpoint the specific defect of the bleeding disorder.

Platelet Disorders. The platelet count is very effective for identifying patients with thrombocytopenia. It is not effective for identifying patients with disorders of platelet function such as von Willebrand disease, Bernard-Soulier disease, Glanzmann disease, uremia, and drug-induced platelet release defects. BT may be prolonged in these patients, but test results are inconsistent. Platelet aggregation tests, ristocetin-induced agglutination, platelet release reaction, and other tests may have to be performed for the nature of the clinical bleeding problem to become apparent.^{15,30,39,41}

Additional laboratory tests are needed to establish the diagnosis and to identify the type of von Willebrand disease. These consist of ristocetin cofactor activity, ristocetin-induced platelet aggregation, immunoassay of

vWF, multimeric analysis of vWF, and specific assays for factor VIII.^{15,30,39,41}

Disorders of the Intrinsic Pathway. Screening tests show prolonged aPTT, normal PT, and normal platelet count (except in some cases of von Willebrand disease). The next step is to mix (mixing tests) the patient's blood with a sample of pooled plasma and repeat the aPTT. If this test is normal, then the specific missing factor is identified by specific assays. If the mixing test result is abnormal, tests for inhibitor activity (antibodies to the factor) are performed. Some acquired coagulation disorders can produce prolonged aPTT along with normal PT. These include the lupus inhibitor, antibodies to factor VIII, and heparin therapy.^{15,30,39,41}

Disorders of the Extrinsic Pathway. A normal aPTT and a prolonged PT suggest a factor VII deficiency, which is very rare, or inhibitors to factor VII. Factor VII deficiency is confirmed by specific assay. Mixing studies are used to rule out factor VII inhibitors.^{15,30,39,41}

Disorders of the Common Pathway. A prolonged aPTT and a prolonged PT in a patient with a history of a

congenital bleeding disorder indicate a common pathway factor deficiency. Congenital deficiency of factors V and X, prothrombin, or fibrinogen is rare. When both of these test results are prolonged, an acquired common pathway factor deficiency is usually indicated. Often, multiple factors are found to be deficient. Conditions that can cause both tests to be abnormal are vitamin K deficiency, liver disease, and DIC. When both test results are prolonged in a patient with a history suggestive of a congenital bleeding problem, the next step is to exclude or identify an abnormality of fibrinogen in the laboratory. This involves measuring the plasma fibrinogen level and performing tests for D-dimer or FDPs. After a problem involving fibrinogen has been ruled out, the next step is to perform mixing studies to rule out inhibitor activity. If these test results are negative, then specific assays for deficiency of factor V or X or prothrombin are performed.^{15,30,39,40}

Degradation Products of Fibrin or Fibrinogen. In patients with prolonged aPTT, PT, and TT, the defect involves the last stage of the common pathway, which is the activation of fibrinogen to form fibrin to stabilize the clot. The plasma level of fibrinogen is determined, and if it is within normal limits, then tests for fibrinolysis are performed. These tests, which detect the presence of fibrinogen, FDPs, or both, consist of staphylococcal clumping assay, agglutination of latex particles coated with antifibrinogen antibody, and euglobulin clot lysis time.^{15,30,39,40}

Disorders with Normal Primary Screening Results. Patients with vascular abnormalities that can cause clinical bleeding may not be identified through the use of recommended screening tests. BT is the only finding that might be abnormal in these patients. However, it has clearly

been shown that BT is inconsistent in these patients. Thus, this test is not reliable for identifying these patients. In most cases, the diagnosis must be based on history and clinical findings.^{15,30,39,40}

Three known defects in the coagulation system do not affect PT, aPTT, or TT. These are rare and include factor XIII deficiency, α_2 plasmin inhibitor deficiency, and plasminogen activator inhibitor-1 deficiency (major inhibitor of plasminogen activators). Patients with a strong clinical history of bleeding and normal coagulation test results (PT, aPTT, and TT) require additional testing, such as the use of 5M urea.^{30,41}

Another small group of patients with a history of significant bleeding problems will have negative test results when screened by means of currently recommended methods. It appears that current methods are unable to reveal whatever disorder these patients may have. A clear-cut history of prolonged bleeding after trauma or surgical procedures is always more significant than negative laboratory data.^{30,41}

MEDICAL MANAGEMENT

In this section, conditions that may cause clinical bleeding are considered. The emphasis is on detection of patients with potential bleeding problems and management of such patients if surgical procedures are needed. Disorders affecting the vascular, platelet, coagulation, and fibrinolytic phases are discussed. DIC, disorders of platelet release, and primary fibrinolysis are described to show the nature of acquired bleeding disorders. These diseases reflect the roles of various factors involved in the control of excessive bleeding after injury, and they reveal what happens when these factors are defective. [Table 24.2](#)

TABLE 24.2 Medical Treatment of Acquired Bleeding Disorders

Condition	Defect	Medical Treatment
Primary thrombocytopenia (idiopathic thrombocytopenia)	Platelets destroyed by autoimmune processes	Prednisone Intravenous gamma globulin Platelet transfusion
Secondary thrombocytopenia	Deficiency of platelets due to accelerated destruction or consumption, deficient production, or abnormal pooling	Platelet transfusion
Liver disease	Multiple coagulation factor defects Patients with portal hypertension may be thrombocytopenic.	Vitamin K Replacement therapy only for serious bleeding or before surgical procedures Desmopressin provides some benefit.
Disseminated intravascular coagulation	Multiple coagulation factor defects caused by triggered consumption Formation of fibrin and fibrinogen degradation products due to fibrinolysis Thrombocytopenia	Treatment of primary disorder Heparin Cryoprecipitate or fresh-frozen plasma for replacement of fibrinogen Platelet transfusion Other blood product replacements lead to mixed results.

summarizes the nature of the defects and the medical treatments available for excessive bleeding in patients with several of the more common acquired disorders covered in this section.

Vascular Defects

Bleeding disorders caused by vascular abnormalities may be caused by structural malformation of vessels, hereditary disorders of connective tissue, and acquired connective tissue disorders.

Acquired connective tissue disorders that may be complicated by bleeding include scurvy, small vessel vasculitis, and skin disorders. In scurvy, deficiency of vitamin C leads to lack of peptidyl hydroxylation of procollagen, resulting in weakened collagen fibers. The abnormal collagen results in defective perivascular supportive tissues, which can lead to capillary fragility and delayed wound healing. In patients on long-term use of steroids, thinning of connective tissues may result in bleeding after minor trauma.^{16,42-44}

Small vessel vasculitis may be caused by a variety of conditions that produce inflammation of small vessels, including arterioles, venules, and capillaries. Serum sickness can lead to purpura through immune complex deposits into vessel walls. Drugs such as penicillin, hydralazine, sulfonamides, and thiazide diuretics and hepatitis have been associated with serum sickness–like reactions.^{16,42,44,45}

Platelet Disorders

Disorders of Platelet Function. Platelets participate directly in the clotting cascade by serving as constituents of factor X and prothrombin-converting complexes through the release of platelet factor 3 (PF3). The potency of this release effect is increased by increased participation of platelets in the clotting process. In some cases, platelets may fail to complete the release reaction of PF3. Sometimes this is caused by defective production of thromboxane and other times by a deficiency in the production of dense-granule ADP.

Defective thromboxane production almost always results from the administration of antiinflammatory drugs. The best-known example is aspirin, which inactivates COX, the first enzyme of the prostaglandin–thromboxane synthetic pathway. Other drugs that interfere with thromboxane formation include NSAIDs (indomethacin, phenylbutazone, ibuprofen, sulfinpyrazone), β -lactam antibiotics; calcium channel–blocking drugs (verapamil, diltiazem, and nifedipine), phenytoin, nitrates, phenothiazines, and tricyclic antidepressants. All platelet release defects produce about the same clinical picture.^{13,33,44}

In otherwise healthy people, the impairment of platelet function that is produced by drugs usually is of no clinical significance. However, in patients with coagulation disorders, uremic or thrombocytopenic patients, and those receiving heparin or coumarin anticoagulants, drug-induced platelet dysfunction can result in serious bleeding. Platelet function studies often show an absence of secondary wave

aggregation. Patients can be screened with standard screening tests; if these results are normal, surgical procedures can be performed.^{13,43,45}

Uremia may interfere with platelet function. This effect can be severe in patients with grossly abnormal platelet function. Such patients are in danger of bleeding to death if injury occurs or surgery is performed. They respond to dialysis, cryoprecipitate, or kidney transplantation but not to platelet replacement. Although β -lactam antibiotics (penicillin and cephalothins) may cause platelet dysfunction, usually no treatment is required. In some undetermined way, alcohol may impair platelet function; this effect may be severe enough to contraindicate surgery unless corrective measures are taken.^{13,33,42,46}

Coagulation Disorders

Disseminated Intravascular Coagulation. Disseminated intravascular coagulation has been reported to occur in about 1 in 1000 hospital admissions. The syndrome is associated with a number of disorders such as infection, obstetric complications, cancer, and snakebites. In fact, worldwide, the most common cause of DIC is snakebite. DIC is a condition that results when the clotting system is activated in all or a major part of the vascular system. Despite widespread fibrin production, the major clinical problem is bleeding, not thrombosis. DIC is caused when large quantities of thromboplastic substances are introduced into the vascular system and “trip” the clotting cascade. Acute DIC may be caused by obstetric complications (abruptio placentae, missed abortion, amniotic fluid embolism), infection, injuries and burns, antigen-antibody complexes, sepsis and septic shock, and acidosis.⁴⁶⁻⁴⁸

Clinical Presentation. Clinical manifestations of acute DIC include severe bleeding from small wounds; purpura; and spontaneous bleeding from the nose, gums, gastrointestinal tract, or urinary tract (Fig. 24.12). Traumatic hemolytic anemia may occur when RBCs are “sliced” by fibrin strands. On rare occasions, bilateral necrosis of the renal cortex has developed. Chronic DIC may occur in association with certain types of cancer. Malignant cells can release thromboplastic material as they die within the tumor mass. Antigen–antibody complexes associated with systemic lupus erythematosus may cause chronic DIC. In the chronic form of the disease, thrombosis is more common than bleeding.⁴⁷⁻⁴⁹

Laboratory and Diagnostic Findings. Consumption and inhibition of the function of clotting factors cause prolongation of the PT, aPTT, and TT. Consumption of platelets causes thrombocytopenia. Secondary fibrinolysis generates increased titers of FDPs, which can be measured by latex agglutination or D-dimer assays. Chronic or compensated forms of DIC are more difficult to diagnose, with highly variable patterns of abnormalities in “DIC screen” coagulation tests. Increased FDPs and a prolonged PT are generally more sensitive measures than abnormalities of the aPTT and platelet count are. Overcompensated synthesis of consumed clotting factors and platelets in



FIG 24.12 Disseminated intravascular coagulation resulting from staphylococcal septicemia in a 56-year-old man. Note the characteristic skin hemorrhage, ranging in extent from small purpuric lesions to larger ecchymoses. The patient had non-insulin-dependent (type 2) diabetes, and the septicemia originated with an untreated large boil on his thigh. (From Forbes CD, Jackson WF: *Color atlas and text of clinical medicine*, ed 3, Edinburgh, 2003, Mosby.)

some chronic forms of DIC may actually cause shortening of the PT and aPTT or thrombocytosis (or both) even though elevated levels of FDPs indicate secondary fibrinolysis in such cases. The most difficult differential diagnosis of DIC occurs in patients who have coexisting liver disease.⁴⁷ The coagulopathy of liver failure is often indistinguishable from that of DIC, partly because advanced hepatic dysfunction is accompanied by a state of DIC. In liver failure, the combination of decreased synthesis of clotting factors, impaired clearance of activated clotting factors, secondary fibrinolysis, and thrombocytopenia from portal hypertension and hypersplenism may make the coagulopathy practically impossible to differentiate from DIC.⁴⁷

Medical Management. Treatment of patients with DIC consists of an attempt to reverse the cause, control of the major symptom (bleeding or thrombosis), and a prophylactic regimen to prevent recurrence in cases of chronic DIC. Consumed coagulation factors need to be replaced, along with missing platelets. Fibrinogen levels must be restored. Cryoprecipitate is used if bleeding is the major problem. Fresh-frozen plasma (FFP) also may be used. If thrombosis is the major problem (early in the process), intravenous (IV) heparin is used. Long-term heparin infusion is used for prophylaxis in cases of chronic DIC.⁴⁶⁻⁴⁸ The use of aminocaproic acid (Amicar), desmopressin, and tranexamic acid preparations is not recommended because increased bleeding may occur.⁴⁷

Fibrinolytic Disorders

Fibrinolysis and Fibrinogenolysis. Primary fibrinolysis may develop if active plasmin is generated in the circulation at a time when the clotting cascade is not in operation. It can occur in patients with liver disease, lung cancer,

prostate cancer, or heatstroke. Severe bleeding results from the depletion of fibrinogen (split by plasmin) and the formation of fibrin split products (with their anticoagulant properties) from fibrinogen.^{16,36,49,50}

Fibrinogenolysis can be treated with ϵ -aminocaproic acid or tranexamic acid, which inhibits both plasmin and plasmin activators; however, these drugs may be dangerous if used in patients with DIC because diffuse thromboses may result. Thus, exclusion of the diagnosis of DIC before antifibrinolytic agents are begun is very important. A specific test such as D-dimer measurement can be used for this purpose.^{16,35,50,51}

Thrombosis and Antithrombotic Therapy. Thrombosis is the formation, from components of blood, of an abnormal mass within the vascular system. It involves the interaction of vascular, cellular, and humoral factors within a flowing stream of blood. Thrombosis and the complicating emboli that may result are one of the most important causes of sickness and death in developed countries. Thrombosis is of greater overall clinical importance in terms of morbidity and mortality than are all of the hemorrhagic disorders combined. Excessive activation of coagulation or inhibition of anticoagulant mechanisms may result in hypercoagulability and thrombosis. Injury to the vessel wall, alterations in blood flow, and changes in the composition of blood are major factors leading to thrombosis.⁵¹⁻⁵⁴

The common causes of acquired venous thrombosis are older age, history of thrombosis, immobilization, obesity, infection, hospitalization, major surgery, and pregnancy. Common causes of both venous and arterial thrombosis are malignancy, hormonal therapy, and DIC. The most common cause of arterial thrombosis is atherosclerosis.^{15,51,55}

Patients should be considered for laboratory evaluation for inherited thrombotic disorders if they are younger than 45 years of age and have recurrent thrombosis. In addition, patients who have experienced a single thrombotic event and have a family history of thrombosis should be tested.²⁹ The inherited thrombotic disorders are covered in [Chapter 25](#).

The pathologic basis for arterial thrombosis involves atherosclerotic vascular disease associated with platelet thrombi. Thrombin is a major mediator in this type of thrombosis. Drug therapy for arterial thrombi involves agents with antithrombin and antiplatelet activity. Venous thrombi usually occur in otherwise normal vessel walls; stasis and hypercoagulability are major predisposing factors. Drugs that prevent thrombin formation or lyse fibrin clots are the main agents used to treat venous thrombi.²⁹ Antidotes are available for overdosing of heparin (protamine) and warfarin (vitamin K); however, none is available for overdosing of the newer anticoagulant drugs, but significant progress is being made to solve this problem ([Fig. 24.13](#)).⁵⁶⁻⁶⁰

Clot collectors (inferior vena caval filters [IVCFs]) can be used to prevent large clots from reaching the lungs



FIG 24.13 Subcutaneous heparin is used to reduce the risk of deep vein thrombosis in medical and surgical procedures. (From Potter PA, Perry AG, Stockert P: *Basic nursing*, ed 7, St. Louis, 2011, Mosby.)



FIG 24.14 An inferior vena caval filter.

(Fig. 24.14). The IVCF can be inserted into the vena cava from an incision in the neck area or in the groin area. The IVCF can be permanent or removed when the risk of a large clot traveling to the lung is over. Complications have been reported with the use of IVCFs; these include the breaking off of pieces of the IVCF and the appliance becoming attached to the vessel wall and unable to be removed.⁵⁸⁻⁶⁰

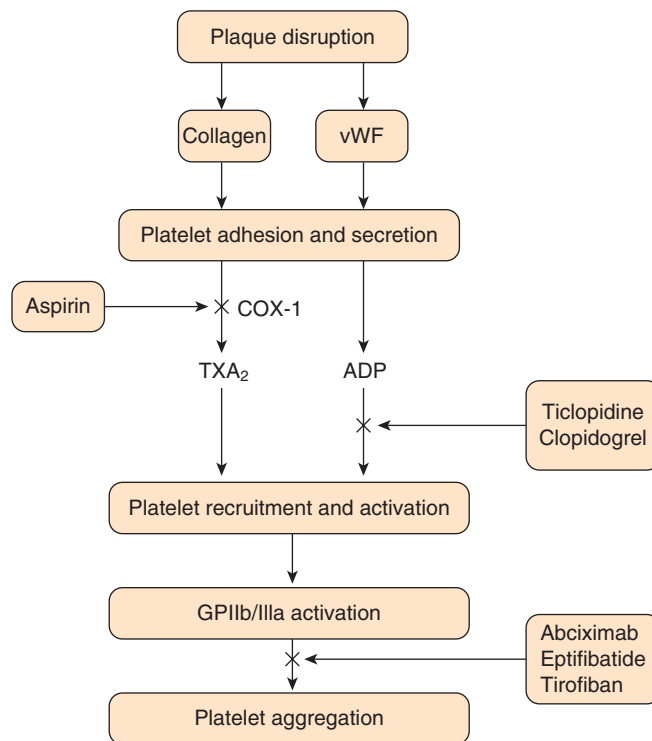

FIG 24.15 Site of action of antiplatelet drugs. Aspirin inhibits thromboxane A₂ (TXA₂) synthesis by irreversibly acetylating cyclooxygenase-1 (COX-1). Reduced TXA₂ release attenuates platelet activation and recruitment to the site of vascular injury. Ticlopidine and clopidogrel irreversibly block P2Y₁₂, a key adenosine diphosphate (ADP) receptor on the platelet surface. Therefore, these agents also attenuate platelet recruitment. Abciximab, eptifibatid, and tirofiban inhibit the final common pathway of platelet aggregation by blocking fibrinogen binding to activated glycoprotein (GP) IIb/IIIa. (From Weitz IC: *Anti-thrombotic drugs*. In Hoffman R, et al, editors: *Hematology: basic principles and practice*, ed 5, Philadelphia, 2009, Churchill Livingstone.)

Anticoagulant Drugs

Heparin. Heparin is used in high doses to treat thromboembolism (IV bolus of 5000 U followed by infusion over a 5- to 10-day period) and in low-dose form for prophylaxis of thromboembolism. Heparin itself is not an anticoagulant. Plasma antithrombin III (ATIII) is the actual anticoagulant, and heparin serves as a catalyst. Patients older than 40 years of age who are about to undergo major surgery should receive prophylaxis with graded compression elastic stockings, low-dose heparin therapy, or intermittent pneumatic compression. If heparin prophylaxis is used, 5000 U is given subcutaneously 2 hours before surgery and every 8 to 12 hours thereafter until the patient is ambulatory (Fig. 24.15). Low-molecular-weight heparin (LMWH) can be used instead of regular heparin and is rapidly becoming the treatment of choice. Patients who are about to undergo total hip or knee replacement should receive postoperative LMWH.^{50,56,57}

Standard heparin consists of an unfractionated heterogeneous mixture of polysaccharide chains with a mean molecular weight of 12,000 to 16,000. It inhibits factor Xa and thrombin equally. Treatment with standard heparin usually consists of an IV infusion in a hospital setting and requires monitoring with aPTT. Standard heparin has a half-life of 1 to 2 hours. LMWH is prepared by depolymerization of unfractionated heparin chains, yielding heparin fragments with a mean molecular weight of 4000 to 6000. LMWH preparations have greater activity against factor Xa than thrombin. LMWHs exhibit less binding to plasma proteins, endothelial cells, and macrophages than is seen with standard heparin. Thus, they have better bioavailability when administered subcutaneously, longer half-lives, and more predictable anticoagulant effects. LMWHs are administered subcutaneously in the abdomen. The dosage is based on body weight, and no laboratory monitoring is needed. The half-life of these preparations is about 2 to 4 hours. Treatment with LMWHs may be provided on an outpatient basis.^{50,56,57}

Low-molecular-weight heparin preparations that are used commonly in North America for the treatment of deep vein thrombosis (DVT) and asymptomatic pulmonary embolism (PE) include dalteparin (Fragmin), enoxaparin (Lovenox), and tinzaparin (Innohep). Their mean molecular weight ranges from 4200 for enoxaparin to 6000 for dalteparin. Their anti-Xa-to-thrombin ratio ranges from 1.9 for tinzaparin to 3.8 for enoxaparin.^{61,62}

Patients with DVT or PE usually are treated with IV heparin in dosages sufficient to prolong the aPTT to a range corresponding to a heparin level of 0.2 to 0.4 u/mL (1.5–2.5 times control value). Heparin therapy is continued for 5 days or longer. Oral anticoagulation with warfarin is started early and should overlap heparin treatment for 4 to 5 days. Heparin treatment is stopped after 5 to 10 days, and warfarin treatment is continued for at least 3 months. Complications with heparin treatment include thrombocytopenia and thrombosis. Starting warfarin therapy early after heparin is first started minimizes these complications. Overdosing of heparin can cause significant clinical bleeding.^{51,57,61}

Synthetic Heparins. Two synthetic heparin analogues are now available for anticoagulant use. Fondaparinux has been approved for thromboprophylaxis in high-risk orthopedic patients; it also appears to provide a useful alternative to heparin or LMWH for the treatment of patients with established venous thromboembolism or PE (5–10 mg given once per day with warfarin). It is also given for prophylaxis for major orthopedic surgery at 2.5 mg once per day starting 6 hours after surgery. The second agent, idraparinux, has a very long half-life (80 hours) and is administered by the subcutaneous route once per week; its efficacy and safety have been established.^{50,56,57}

Direct Thrombin Inhibitors. Heparin and LMWH are indirect inhibitors of thrombin because their activity is mediated by antithrombin. Direct thrombin inhibitors

that do not require a plasma cofactor and are available for clinical use. Parenteral direct thrombin inhibitors available include lepirudin, desirudin, argatroban, and bivalirudin. Lepirudin, desirudin, and bivalirudin are hirudins produced by recombinant DNA technology. Desirudin is given subcutaneously to patients who are about to undergo hip replacement. Lepirudin is given intravenously to patients with history of heparin-induced thrombocytopenia (HIT) for treatment of DVT or for hip replacement. Bivalirudin is administered to patients about to undergo percutaneous coronary intervention. Argatroban may also be used in patients with a history of HIT. It is given by continuous infusion.^{51,57,61} The first orally administered direct thrombin inhibitor, dabigatran (Pradaxa), gained U.S. Food and Drug Administration approval in 2010 for use to prevent stroke in patients with atrial fibrillation in the United States.²⁹ Dabigatran has replaced warfarin as a standard anticoagulant with the main advantages that INR monitoring is not needed, and it is not affected by foods.⁶³

Direct Factor Xa Inhibitors. Several anticoagulants act as direct factor Xa inhibitors. One is rivaroxaban (Xarelto), an orally administered anticoagulant.^{64–66} It was approved in 2011 for use in the United States. Rivaroxaban has in general a low rate of major bleeding complications.^{6,63,67} It is well accepted and can result in better adherence.^{67,68} Others direct factor Xa inhibitors include apixaban (Eliquis) and betrixaban approved in 2014 for use in the United States.^{69–73}

Coumarin. Warfarin (Coumadin), the most widely used coumarin in the United States, is an oral anticoagulant that inhibits the biosynthesis of vitamin K–dependent coagulation proteins (factors VII, IX, and X and prothrombin). Warfarin is named after the patent holder, Wisconsin Alumni Research Foundation. Warfarin is bound to albumin, metabolized through hydroxylation by the liver, and excreted in the urine. PT is used to monitor warfarin therapy because it measures three of the vitamin K–dependent coagulation proteins: factors VII and X and prothrombin. PT is particularly sensitive to factor VII deficiency. Therapeutic anticoagulation with warfarin takes 4 to 5 days.^{51,57,61}

PT has been shown to be imprecise and variable. Little comparability has been seen of PT values obtained from different laboratories. These differences are caused by the source of thromboplastin (human brain, rabbit brain), the brand of thromboplastin, and the type of instrumentation used. This has caused problems with bleeding that results from a high degree of anticoagulation based on an artificially low PTT. INR is now used to monitor patients on warfarin therapy. Reliance on the INR ($INR = [PTR]^{ISI}$; PTR = prothrombin time ratio; ISI = international sensitivity index for the thromboplastin used) allows better comparison of PT values among different laboratories and minimizes the risk of bleeding caused by artificially low PT values.²⁹ The recommended INR goal for a patient on low-intensity warfarin therapy

TABLE 24.3 Recommended Therapeutic Range for Warfarin Therapy

INR 2.0–3.0 WITH A TARGET OF 2.5
Prophylaxis of venous thrombosis (high-risk surgery)
Treatment of venous thrombosis
Treatment of PE
Prevention of systemic embolism
Tissue heart valves in aortic or mitral position for first 3 months
Tissue heart valves with history of PE
Tissue heart valves with atrial fibrillation
Acute MI
Atrial fibrillation
Valvular heart disease
Mitral valve prolapse with history of atrial fibrillation or embolism
INR 2.5–3.5 WITH A TARGET OF 3.0
Mechanical prosthetic heart valves
Prevention of recurrent MI
Treatment of thrombosis associated with antiphospholipid antibodies

INR, International normalized ratio; MI, myocardial infarction; PE, pulmonary embolism.

Data from Hirsh J, Schulman S: Antithrombotic therapy. In Goldman L, Ausiello D, editors: *Cecil textbook of medicine*, ed 23, Philadelphia, 2008, Saunders; Begelman SM: Venous thromboembolism. In Carey WD, et al, editors: *Current clinical medicine 2009—Cleveland Clinic*, Philadelphia, 2009, Saunders, pp. 205-211; and Lim W, et al: Venous thromboembolism. In Hoffman R, et al, editors: *Hematology: basic principles and practice*, ed 5, Philadelphia, 2009, Churchill Livingstone.

is 2.5, with a range of 2.0 to 3.0. With a patient on high-intensity anticoagulation therapy, the INR goal is 3.0, with a range of 2.5 to 3.5. Table 24.3 shows the conditions for which warfarin therapy is recommended and the recommended INR.^{50,56,57} Fig. 24.16 shows a patient with DVT, which is one of the conditions for which warfarin treatment is used. Table 24.4 summarizes the anticoagulants now in use.

Antiplatelet Drugs. Platelets are an important contributor to arterial thrombi. Antiplatelet treatment has been reported to reduce overall mortality rate from vascular disease by 15% and to reduce nonfatal vascular complications by 30%. Aspirin, the prototypical antiplatelet drug, exerts its antithrombotic action by irreversibly inhibiting platelet COX, preventing synthesis of thromboxane A₂, and impairing platelet secretion and aggregation. Aspirin is the least expensive, most widely used, and most widely studied antiplatelet drug. NSAIDs such as ibuprofen and indobufen act as reversible inhibitors of COX and are used clinically to some extent. Dipyridamole, which increases cyclic adenosine monophosphate; ticlopidine and clopidogrel, which inhibit ADP; and abciximab, a monoclonal antibody; and the small molecule inhibitors, eptifibatide and tirofiban, that block the fibrinogen receptor glycoprotein IIb/IIIa are all used as antiplatelet agents. However, dipyridamole alone has been reported to be



FIG 24.16 Deep vein thrombosis manifesting as an acutely swollen left leg. (From Swartz MH: *Textbook of physical diagnosis: history and examination*, ed 6, Philadelphia, 2010, Saunders.)

ineffective, and is now given with aspirin.^{50,56,73} The antiplatelet drugs are summarized in Table 24.5.

Clopidogrel is metabolized by the liver resulting in active metabolites. Thus, the inhibitory effect of this drug on platelet function is delayed after administration. Clopidogrel is associated with a low risk for development of neutropenia or thrombocytopenia.⁵³ Aspirin and clopidogrel are used in combination to maintain patency of arterial stents.⁵³ Abciximab produces an immediate and profound inhibition of platelet activity that lasts for 6 to 12 hours after the last dosage. Eptifibatide and tirofiban have shorter half-lives, and platelet function returns to normal within 4 to 8 hours after the last dosage. Drug-induced thrombocytopenia is more common with abciximab than with the eptifibatide and tirofiban.⁵³

PREOPERATIVE EVALUATION OF HEMOSTASIS

Most experts do not recommend routine preoperative screening for potential bleeding disorders in patients with a negative history and clinical findings who are scheduled for minor surgery such as dental extractions and biopsy procedures. However, patients with a negative history for excessive bleeding who are scheduled for major surgery should be screened with use of platelet count and aPTT. Patients with an equivocal bleeding

TABLE 24.4 Current Antithrombotic Agents: Anticoagulants

Agent	Indications	Dosage	Monitoring	Complications
HEPARINS				
Standard high-dose heparin	Treatment of DVT and PE Prevention of DVT	IV bolus: 5000–10,000 units; IV infusion at rate of 1300 U/hr over 5–10 days	aPTT 1.5–2.5 times the mean laboratory control value	Bleeding Thrombocytopenia
Standard low-dose heparin	Prevention of DVT	SC: 5000 units 2 hr before surgery and every 8–12 hr until ambulatory	None	Bleeding Thrombocytopenia
Warfarin (Coumadin)	Treatment of DVT and PE Prevention of DVT or thrombosis in AF: MPHV Prevention of recurrent MI	PO: 5–7 mg/day for 3–6 mo PO: 7–10 mg/day, long term	INR: 2.0–3.0 INR: 2.5–3.5	Bleeding Intolerance Alopecia GI discomfort Rash, skin necrosis
LOW-MOLECULAR-WEIGHT HEPARINS				
Enoxaparin (Lovenox)	Prevention of DVT and PE Treatment of DVT	Enoxaparin: 30 mg SC every 12 hr for up to 14 days (knee or hip) 40 mg SC once daily, with first dose 2 hr before abdominal surgery 1 mg/kg SC every 12 hr up to 5 days	None Oral warfarin started within 72 hr	Bleeding Thrombocytopenia Anemia Fever Peripheral edema
Dalteparin (Fragmin)				
SYNTHETIC HEPARINS				
Fondaparinux (Arixtra)	Prevention and treatment of DVT	SC: 2.5–10 mg/day	None	Bleeding
Idraparinux: Because of complications, it was taken off the market.				
Direct factor Xa inhibitors				
Rivaroxaban (Xarelto)	Rivaroxaban gained FDA approval in July 2011 for prevention of DVT in orthopedic patients; approval for apixaban occurred at the end of 2011	Rivaroxaban given PO, 10 mg/day for 13 days for knee replacement surgery and for 35 days for hip replacements	None	Bleeding Nausea and vomiting Anemia Xerostomia Increase in liver transaminases
Apixaban (Eliquis)				

AF, Atrial fibrillation; DVT, deep venous thrombosis; FDA, Federal Drug Administration; GI, gastrointestinal; HIT, heparin-induced thrombocytopenia; IV, intravenously; MI, myocardial infarction; MPHV, mechanical prosthetic heart valve; PE, pulmonary embolus; PO, oral; SC, subcutaneously; TIA, transient ischemic attack.

history who are scheduled for major surgery involving hemostatic impairment (heart bypass machine) should be screened with use of PT, aPTT, platelet count, factor XIII assay, and euglobulin clot lysis time. All patients with a positive bleeding history who are scheduled for minor or major surgery should be screened with use of PT, aPTT, platelet count, factor XIII assay, and euglobulin clot lysis time.^{16,41} Patients with a significant history of a bleeding disorder should be referred to a hematologist for all screening and diagnostic testing. Patients with a history suggestive of a possible bleeding disorder may be screened by the dentist at a commercial laboratory

or may be referred to a hematologist for screening. If the dentist orders screening tests, aPTT, PT, TT, and platelet count should be used.

DENTAL MANAGEMENT

Patient Identification

The four methods by which the dentist can identify the patient who may have a bleeding problem are listed here. Skills acquired through application of these methods determine how well dentists can protect certain patients from the dangers of excessive bleeding after dental surgical

TABLE 24.5 Antidotes for Antithrombotic Agents

Agent	Antidote	No Antidote
Standard heparin High dose Low dose	Protamine sulfate	
Warfarin (Coumadin)	Vitamin K	
LMWHs	Protamine sulfate with limited effectiveness	Limited effectiveness for antidote
Fondaparinux		No antidote
Idraparinux		No antidote
Dabigatran (Pradaxa)*		Idarucizumab
Rivaroxaban (Xarelto) [†]		Prothrombin complex concentrate with limited success
Apixaban (Eliquis)		No antidote

*Idarucizumab: The first novel antidote against dabigatran was approved by the Food and Drug Administration in October 2015.

[†]Andexanet alfa, a specific reversal agent against factor Xa inhibitors, has shown promise and is in phase IV studies.

treatment. The four risk assessment methods consist of the following:

- A thorough history
- Physical examination
- Screening clinical laboratory tests
- Observation of excessive bleeding after a surgical procedure (Box 24.6)

History and Symptoms

The history provides the basis for the search for a potential bleeder in dental practice. To maximize the value of the patient's history in identifying patients who may be bleeders, several points must be considered.⁹ Some healthy persons have been shown to consider their bleeding and bruising excessive; 23% in one study reported a positive bleeding history.¹⁷ Patients with severe coagulation disorders may have dramatic abnormal bleeding histories but often do not volunteer this information unless asked. Patients with mild to moderate bleeding abnormalities may not have experienced excessive bleeding symptoms or may be unable to recognize subtle symptoms as abnormal.

In obtaining a good bleeding history, the dentist must go beyond a list of questions that the patient can respond to on a questionnaire. This involves an active process led by the dentist that starts with the patient's initial responses on the questionnaire and continues with expansion and clarification of this information.

The history should include questions on the following topics:

1. Presence of bleeding problems in relatives
2. Excessive bleeding after operations, surgical procedures, and tooth extractions

BOX 24.6 Clinical Recognition of the Patient Who Is a "Bleeder"

1. History
 - a. Bleeding problems in relatives
 - b. Bleeding problems after operations and tooth extractions
 - c. Bleeding problems after trauma (e.g., cuts, scrapes)
 - d. Medications that may cause bleeding problems
 - (1) Aspirin
 - (2) Anticoagulants
 - (3) Long-term antibiotic therapy
 - (4) Certain herbal preparations
 - e. Presence of illnesses that may be associated with bleeding problems
 - (1) Leukemia
 - (2) Liver disease
 - (3) Hemophilia
 - (4) Congenital heart disease
 - (5) Renal disease—uremia
 - f. Spontaneous bleeding from nose, mouth, ears
2. Examination findings
 - a. Jaundice, pallor
 - b. Spider angiomas
 - c. Ecchymoses
 - d. Petechiae
 - e. Oral ulcers
 - f. Hyperplastic gingival tissues
 - g. Hemarthrosis
3. Screening laboratory tests
 - a. PT
 - b. aPTT
 - c. TT
 - d. Platelet count
4. Surgical procedure—excessive bleeding after surgery may be first clue to underlying bleeding problem

aPTT, Activated partial thromboplastin time; PT, prothrombin time; TT, thrombin time.

3. Excessive bleeding after trauma
4. Use of drugs for the prevention of coagulation or chronic pain
5. Past and present illness, including presence and severity of liver disease
6. Occurrence of spontaneous bleeding

Bleeding Problems in Relatives. The presence of bleeding problems in relatives is covered in Chapter 25 on congenital bleeding disorders.

Bleeding Problems After Operations and Tooth Extraction. Each new patient should be questioned about excessive bleeding after major or minor operations. The number of patients who have had an appendectomy, a tonsillectomy, periodontal procedures (surgery or root scaling), or tooth extraction is large. Usually, the extraction of molar teeth is more traumatic than the extraction of incisors. A patient who reports prolonged bleeding after tooth extraction or other dental procedures should be asked whether it was necessary to return to the dentist

for packing, suturing, or referral for transfusion of blood products.

Persons who have undergone major operations without a bleeding problem do not have a significant inherited coagulation disorder. Nevertheless, absence of a significant acquired bleeding problem at the time of the operative procedure does not mean that the patient is free of such a problem that may have been acquired since the last surgery.

Establishing the length of prolonged bleeding and the amount of blood that was lost is important. For example, normally, a small amount of blood may ooze from an extraction site for several hours or so. Oozing of blood from an extraction site for several days is abnormal unless a local infection was present. Some blood may be found on a pillow on the day after an extraction, but a pillow soaked with blood is abnormal. Another area to ask about is the need for blood replacement after surgery; this is most important if it was required during the postoperative period. Another important question explores whether the patient required hospitalization for the bleeding problem.

The patient should be asked whether the excessive bleeding started soon after minor surgical procedures or whether it was delayed in its onset. When excessive bleeding has been reported after minor surgery, the patient should be asked whether he or she sought medical attention and treatment. If treatment was rendered, the dentist should attempt to establish what type of treatment was given. Recall patients should be asked about any surgical procedures that have been performed since the last dental visit and whether excessive bleeding occurred.

The patient should be asked about visits to other doctors for bleeding problems and any laboratory data that may be available; a history of transfusion of whole blood, packed RBCs, plasma, platelets, or coagulation factor concentrates; a history of hospitalization for a bleeding problem; and a documented history of anemia or physician-prescribed iron therapy.¹⁷

Bleeding Problems After Trauma. All dental patients should be asked whether they have experienced any recent trauma and, if so, whether excessive bleeding followed it. The more severe the trauma (knife wounds, automobile accidents), the more likely it is that the presence of an underlying bleeding disorder will be exposed. Small cuts in patients with coagulation disorders may not cause excessive bleeding initially because the vascular and platelet phases may be sufficient to control blood loss even if a defect in coagulation is found. However, small cuts in patients with platelet or vascular deficiencies usually result in excessive bleeding, and in patients with severe coagulation disorders, this may lead to bleeding several hours after the injury.

The most meaningful data are reported as a recent negative or positive history of excessive bleeding after a major hemostatic challenge. With a negative history, the patient is not a bleeder. By contrast, a patient with a positive history is a bleeder. A negative history of bleeding

after minor insults in a patient with a mild bleeding diathesis does not rule out a problem with more severe surgical or traumatic events. Thus, the more recent and severe the surgical or traumatic event, the more accurate it will be in revealing the presence of a bleeding disorder.

Medications That May Cause Bleeding. All new and recall dental patients should be asked whether they are taking an anticoagulant drug such as heparin (by the IV route), LMWH (by the subcutaneous route), a coumarin derivative, a direct thrombin inhibitor, or a factor Xa inhibitor. If the patient is receiving one of these drugs, the dentist should contact the patient's physician to find out what degree of anticoagulation is being maintained and the purpose for which the drug is being used. All patients should be asked whether they have been taking aspirin or drugs that contain aspirin or other antiplatelet medications. Patients also should be asked whether they have undergone recent treatment with a broad-spectrum antibiotic and about excessive use of alcohol as each of these can increase the risk for excessive postoperative bleeding. Some herbal preparations and vitamin supplements may cause excessive bleeding (see [Appendix E](#)), as may some over-the-counter medications. The dentist must inquire about the use of such medications, particularly in the patient with a bleeding history.

Presence of Illness Potentially Associated With Bleeding Problems. The past and current medical status of the patient must be reviewed. This assessment should identify a history of liver disease, biliary tract obstruction, malabsorption problems, infectious diseases, genetic coagulation disorders, chronic inflammatory diseases, chronic renal disease, or leukemia or other types of cancer and whether the patient has received radiation therapy or has been exposed to large amounts of radiation. It also must be determined whether patients with cancer are being treated with chemotherapy because such treatment can cause significant suppression of platelet production.

Spontaneous Bleeding. Each patient should be asked about a history of spontaneous bleeding, including gingival, nasal, urinary, rectal, gastrointestinal, oral, pulmonary, and, in women, vaginal sources of bleeding. If spontaneous bleeding has occurred, the frequency, amount of blood lost, appearance of the blood, and steps that were necessary to stop it should be determined. A history of gingival bleeding is given by as many as 5% of healthy men and 50% of healthy women.⁹ This bleeding may be related to periodontal disease or to the use of stiff-bristled toothbrushes. It is important to establish the frequency of gingival bleeding and to determine whether the bleeding occurs spontaneously. Excessive gingival bleeding, when it occurs, usually is related to thrombocytopenia, platelet disorders, or von Willebrand disease.

Physical Examination

The dentist should inspect the exposed skin and mucosa of the oral cavity and pharynx of the patient for signs

that might indicate a possible bleeding disorder. These include petechiae, ecchymoses (bruises), spider angioma, telangiectasias, jaundice, pallor, and cyanosis. When any of these signs are found by the dentist and cannot be explained by the history or other clinical findings, the patient should be referred for medical evaluation.

Screening Laboratory Tests

The dentist can use four clinical laboratory tests to screen patients for bleeding disorders (Box 24.7): platelet count, aPTT, PT, and TT. The platelet count is ordered to screen for thrombocytopenia. The aPTT test is used to measure the status of the intrinsic and common pathways of coagulation. This test reflects the ability of blood remaining within vessels in the area of injury to coagulate. It will be prolonged in coagulation disorders affecting the intrinsic and common pathways (hemophilia, liver disease) and in cases of excessive fibrinolysis.

The PT test is used to measure the status of the extrinsic and common pathways of coagulation. This test reflects the ability of blood lost from vessels in the area of injury to coagulate. It will be prolonged in cases of factor VII deficiency (which is rare) and in disorders affecting the common pathway and fibrinolysis. This test usually is normal in patients with intrinsic pathway defects (hemophilia).

The TT test uses thrombin as the test-activating agent; hence, it measures only the ability of fibrinogen to form an initial clot. Because FDPs tend to prolong TT, this test becomes reasonably sensitive for fibrinolysis disorders. When performed along with PT and aPTT tests, it allows

for the identification of coagulation disorders involving the last “stage” of the sequence—for example, if PT, aPTT, and TT all were prolonged, the problem in the coagulation system would occur at the point of conversion of fibrinogen to the initial clot.

If positive, the results of these screening tests direct the hematologist to the possible source of a bleeding disorder and allow for the selection of more specific tests to identify the nature of the defect.

Surgical Procedures

Prolonged bleeding after a surgical procedure may be the first indication of a bleeding problem in a patient with a negative history and clinical findings. The dentist should use the appropriate local procedures (Table 24.6) in an attempt to control the bleeding. If these measures should fail, consultation with the patient’s physician or hematologist is indicated. Screening laboratory tests may be ordered to better identify the source of the problem before the consultation.

Medical Considerations

Surgical procedures should not be performed on a patient who is suspected of having a bleeding problem on the basis of history and physical examination findings. Such a patient should be screened by a dentist through appropriate clinical laboratory tests or should be referred to a hematologist for screening. Patients screened by a dentist with abnormal test results should be referred to a hematologist for diagnosis, treatment, and management recommendations. Patients under medical care who may have a bleeding problem should not receive dental treatment until consultation with the patient’s physician has taken place and appropriate preparations have been made to avoid excessive bleeding after dental procedures.

Certain specific clinical situations often present the dentist with the question of whether a given patient has a bleeding problem. Each of these situations is discussed in Box 24.8.

Absence of Clinical or Historical Clues to Cause a Bleeding Problem. A person with a potential bleeding problem may not have subjective or objective findings suggestive of the underlying condition. The first indication may be prolonged bleeding after a dental surgical procedure. For this, local measures should be taken to control the bleeding; if these fail, a hematologist may have to be consulted. After the problem has been brought under control, the patient should be screened with the appropriate laboratory tests (PT, aPTT, platelet count, and TT) by the dentist through a commercial clinical laboratory or by a hematologist.

History or Clinical Findings (or Both) Suggestive of Possible Bleeding Problem in the Absence of Clues to Its Cause. When clues are not evident regarding the cause of a potential bleeding problem in a patient, all four screening laboratory tests should be performed. The stronger the history of excessive bleeding, the more advantageous it is to refer the patient to a hematologist for screening and diagnosis.

BOX 24.7 Screening Laboratory Tests for Detection of a Potential “Bleeder”

1. PT—activated by tissue thromboplastin
 - a. Tests extrinsic and common pathways.
 - b. Control should be run.
 - c. Normal PT is 11 to 15 seconds, depending on laboratory.
 - d. Control must be in normal range.
2. aPTT—initiated by phospholipid platelet substitute and activated by addition of contact activator (kaolin)
 - a. Tests intrinsic and common pathways.
 - b. Control should be run.
 - c. Normal aPTT is 25 to 35 seconds, depending on laboratory.
 - d. Control must be in normal range.
3. TT—activated by thrombin
 - a. Tests ability to form initial clot from fibrinogen.
 - b. Controls should be run.
 - c. Normal TT is 9 to 13 seconds.
4. Platelet count
 - a. Tests platelet phase for adequate number of platelets.
 - b. Normal count is 140,000 to 400,000/ μ L.
 - c. Clinical bleeding problem can occur if count is less than 50,000/ μ L.

aPTT, Activated partial thromboplastin time; PT, prothrombin time; TT, thrombin time.

TABLE 24.6 Current Antithrombotic Agents: Antiplatelet Drugs

Agent	Indication(s)	Dosage	Monitoring	Complications
Aspirin	Prevention: recurrent MI, stroke, coronary thrombosis	PO: 75–325 mg once daily	Usually none	GI bleeding Tinnitus Urticaria Bronchospasm
Aspirin plus dipyridamole (Aggrenox)	Stroke prevention (history of TIA)	PO: aspirin: 50 mg bid; dipyridamole: 200 mg	Usually none	GI bleeding GI ulceration Urticaria Bronchospasm
NSAIDs Ibuprofen (Advil, Motrin)	Prevention: recurrent MI, stroke, coronary thrombosis	PO: 400 mg once daily	Usually none	GI bleeding GI ulceration Rash, urticaria Tinnitus
ADP inhibitors Clopidogrel (Plavix) Ticlopidine (Ticlid)	Prevention: TIA, stroke, and MI	PO: clopidogrel: 75 mg once daily; ticlopidine: 250 mg bid	Usually none CBC every 2 wk	GI bleeding Thrombocytopenia Diarrhea
Fibrinogen receptor inhibitors (GP IIb/IIIa) Tirofiban (Aggrastat) Abciximab (ReoPro) Eptifibatid (Integrilin)	Prevention: recurrent MI, stroke, TIA	Tirofiban: IV 0.4 µg/kg/min for 30 min; then 0.1 µg/kg/min until steady state achieved	Usually none	GI bleeding GI ulceration Rash Neutropenia Thrombocytopenia

ADP, Adenosine diphosphate; *bid*, twice a day; *CBC*, complete blood count; *GI*, gastrointestinal; *GP*, glycoprotein; *IV*, intravenously; *MI*, myocardial infarction; *NSAID*, nonsteroidal antiinflammatory drug; *Rx*, prescription; *TIA*, transient ischemic attack.

BOX 24.8 Selection of Screening Laboratory Tests for Clinical Recognition of the Patient With a Potential Bleeding Problem Based on History and Examination Findings

1. No clinical or historical clues to cause of bleeding problem: excessive bleeding occurs after surgery
2. History or clinical findings or both suggest possible bleeding problem but no clues to the cause: PT, aPTT, TT, platelet count
3. Aspirin therapy: PFA-100 if available
4. Warfarin (Coumadin) therapy: INR; LMWH: aPPT
5. Possible liver disease: platelet count, PT
6. Chronic leukemia: platelet count
7. Malabsorption syndrome or long-term antibiotic therapy: PT
8. Renal dialysis (heparin): aPTT
9. Vascular wall alteration: BT (results often inconsistent)
10. Primary fibrinogenolysis (active plasmin in circulation), cancers (lung, prostate): TT

aPTT, Activated partial thromboplastin time; *BT*, bleeding time; *INR*, international normalized ratio; *LMWH*, low-molecular-weight heparin; *PT*, prothrombin time; *TT*, thrombin time.

In other cases, the patient's physician can order these tests, or the dentist can order them through a clinical laboratory facility (see Box 24.7).

Antiplatelet Therapy. Patients who are receiving aspirin therapy may have a bleeding problem because of the drug's effect on platelets. Some of these patients may have been receiving high doses (20 g or more, or four or more tablets) of aspirin each day for a prolonged period

(longer than 1 week). Others have been taking one tablet a day or one tablet every other day to prevent coronary thrombosis. Even this low dosage of aspirin is enough to inhibit platelet thromboxane production and platelet aggregation. Although these effects are nonreversible, they generally are not clinically significant.^{6,34} Thus, aspirin use does not usually lead to a significant bleeding problem, and invasive dental procedures can be performed. If major surgery must be performed under emergency conditions, desmopressin (DDAVP) can be used to reduce the risk of excessive bleeding. This should be done in consultation with the patient's physician or hematologist.^{13,51,57}

Nonsteroidal antiinflammatory drugs can also inhibit platelet COX, thereby blocking the formation of thromboxane A₂. These drugs produce a systemic bleeding tendency by impairing thromboxane-dependent platelet aggregation. However, they inhibit COX reversibly, and the duration of their action depends on the specific drug dose given, the serum level, and the half-life. Most invasive dental procedures can be performed without adjusting the dose. If the patient's physician recommends stopping the drug, after three half-lives of the drug have passed, the drug levels will be sufficiently eliminated to allow return of normal platelet function. It should be remembered that the clinical risks of bleeding with aspirin or nonaspirin NSAIDs are enhanced by the use of alcohol or anticoagulants and by associated conditions such as advanced age, liver disease, and other coexisting coagulopathies.^{6,33,44}

A common use for the antiplatelet ADP inhibitors, clopidogrel and ticlopidine, is to prevent thrombosis in arterial stents. Clopidogrel is used the most often and is

given as a single agent or as a dual agent with aspirin. In 2007, a science advisory from the American Heart Association, American College of Cardiology, Society for Cardiovascular Angiography and Interventions, American College of Surgeons, and American Dental Association, with representation from the American College of Physicians, was published.⁷⁰ This advisory stressed the importance of 12 months of dual antiplatelet therapy after placement of a drug-eluting stent and educating patients and health care providers about hazards of premature discontinuation. It also recommends postponing elective surgery for 1 year, and if surgery cannot be deferred, considering the continuation of aspirin during the perioperative period in high-risk patients with drug-eluting stents.⁷⁰

In a recent study involving patients taking single or dual antiplatelet therapy who had invasive dental procedures (extractions, periodontal surgery, subgingival scaling, and root planing), it was found that no episodes of prolonged bleeding occurred.⁷² At this time, it appears to be safe for patients taking single ticlopidine or clopidogrel therapy or dual therapy with aspirin to be maintained on their medication(s) for invasive dental procedures. For major oral surgical procedures that cannot be delayed, the thienopyridines may have to be discontinued until after the surgery. Consultation with the patient's physician is recommended.

The fibrinogen receptor inhibitors tirofiban, abciximab, and eptifibatid are injectable (IV) antiplatelet drugs used in emergency coronary situations, usually in a hospital setting. The dentist is very unlikely to be faced with the management of patients taking these drugs unless called to the hospital for dental emergency care for a patient with acute coronary syndrome or myocardial infarction. Under these conditions, the dentist should consult with the attending physician regarding the management of the patient. In general, the most conservative dental treatment should be selected to deal with the dental problem without any changes in the patient's medications or dosage.

Coumarin Therapy. The major concern in performing surgical or invasive dental procedures on patients who are taking warfarin (Coumadin) is the potential for excessive bleeding.⁶³ In contrast, if the anticoagulant is discontinued in preparation for the dental procedure, the major medical concern is thrombosis, which could be life threatening. The literature clearly supports the continuation of warfarin anticoagulation therapy for minor oral surgery and other similarly invasive dental procedures if the INR is 3.5 or less.^{57,74-79} It is estimated that for every increase of 1.0 in the INR over 3.5, the risk for bleeding doubles.⁶² For major oral surgery, the literature is less clear on management of the warfarin level. If other bleeding problems, such as liver disease and renal disease, are present or if other drugs (e.g., aspirin, antibiotics, NSAIDs) are being taken, management of the patient will have to be planned on an individual basis. Before performing surgical or invasive dental procedures, the dentist should

obtain medical consultation for all patients who are taking warfarin.

If acute infection is present, surgery should be avoided until the infection has been treated. When the patient is free of acute infection and the INR is 3.5 or less, minor surgery can be performed. The procedure should be done with as little trauma as possible.

The American College of Chest Physicians and the American Heart Association/American College of Cardiology also recommend that warfarin therapy should not be interrupted for invasive dental procedures and that a tranexamic acid (Cyklokapron) or epsilon aminocaproic acid (EACA) (Amicar) mouthwash should be applied during the first 2 postoperative days to help control excessive bleeding.^{77,80} Tranexamic acid rinses are used in other countries and are not readily available in the United States. For stability and sterility reasons, the Amicar solution can be prepared in the dental clinic on the day it is to be used.⁸¹ A 5-g vial for injection (20 mL, containing 5 g of Amicar and 0.9% benzyl alcohol preservative) may be diluted with sterile water to a total volume of 100 mL. The patient is instructed to hold 10 mL of the Amicar solution (1.00 g of Amicar) in the area of the dental or surgical procedure for 2 minutes just before the procedure and every 1 to 2 hours after the procedure until all of the solution is gone. The patient is instructed not to "swish" to avoid dislodging a clot. Activities such as sucking on a straw or candy should be avoided because negative pressure may dislodge the clot.⁸¹

If excessive postoperative bleeding occurs after an extraction, Gelfoam with thrombin may be placed in the socket to control it. In addition, primary closure over the socket is desirable. Oxycel, Surgicel, or microfibrillar collagen may be used in place of Gelfoam (see [Table 24.6](#)). However, thrombin should not be used in combination with these agents because it is inactivated as a result of pH factors, thus representing an additional cost with no real benefits. An inhibitor of fibrinolysis (tranexamic acid or EACA) also can be applied.⁸²⁻⁸⁴

If excessive bleeding cannot be controlled by the local methods listed earlier, the dentist should consult the patient's physician. Available options include discontinuation of warfarin, which would take several days before an effect on bleeding would occur; administration of vitamin K; and administration of FFP or a prothrombin concentrate. Vitamin K can be given by the IV route (rapid response but slight risk of anaphylaxis), subcutaneously (response is unpredictable and sometimes delayed), or orally (predictable response, effective, convenient, safe, and effect seen within 24 hours). FFP carries a risk of infection, and prothrombin concentrate is associated with a risk of thromboembolic complications. Another option is to administer recombinant factor VIIa.²⁹

Box 24.9 summarizes appropriate dental management of the patient who is taking warfarin or Coumadin. If the dosage of anticoagulant must be adjusted, the patient's physician should instruct the patient. It will take 3 to 5

BOX 24.9 Dental Management Considerations in Patients Taking Warfarin (Coumadin)**P Patient Evaluation and Risk Assessment (see Box 1.1)**

- Confirm INR level before surgical procedures.

Potential Issues and Factors of Concern**A**

Analgesics	Avoid aspirin, aspirin-containing compounds, and other NSAIDs; acetaminophen with or without codeine is suggested for most patients.
Antibiotics	Not indicated unless acute infection is present.
Anesthesia	No issues
Anxiety	No issues

B

Bleeding	The risk for excessive bleeding after invasive dental procedures depends on the level of the patient's INR. If the INR is greater than 3.5, significant bleeding may occur after invasive dental and surgical procedures. These procedures can be performed with little risk of significant bleeding if the INR is between 2.0 and 3.5. If the INR is between 3.0 and 3.5, significant bleeding may occur with major oral surgery and the INR may have to be reduced to 3.0 or lower.
Breathing	No issues
Blood pressure	No issues

C

Chair position	No issues
Cardiovascular	Determine reason for anticoagulation therapy; if for cardiac reason, take appropriate management actions.
Consultation	The dentist should consult with the patient's physician to determine the level of anticoagulation being maintained with warfarin therapy. If invasive procedures or minor oral surgery are planned and the patient's INR is between 2.0 and 3.5, no adjustment in the warfarin dosage is indicated. If the INR is greater than 3.5, the dentist should request that the dosage be reduced to allow the INR to fall in the range of 2.0 to 3.5. Also, if major oral surgery is planned and the patient's INR is between 3.0 and 3.5, the dentist may request that the dosage be reduced to allow the INR to fall in the range of 2.0 to 3.0. If the dosage of warfarin is reduced by the patient's physician it will take 3 to 5 days for the desired reduction to occur. The reduction should be confirmed by INR before the dental or surgical procedure which should be scheduled within 2 days after confirmation of the reduction. After it has been determined by the dentist that there are no significant complications (bleeding, infection, poor healing), the patient's physician should be contacted to resume the patient's usual warfarin dosage.

D

Devices	No issues
Drugs	Avoid all drugs that may cause bleeding or potentiate the anticoagulation action of warfarin, such as aspirin or other NSAIDs, metronidazole, broad-spectrum antibiotics, erythromycin, herbal medications, and over-the-counter drugs containing aspirin. Also, drugs such as barbiturates, steroids, and nafcillin that will antagonize the action of warfarin should be avoided.

E

Equipment	No issues
Emergencies	Excessive bleeding may occur after invasive dental procedures or surgery, and local means may be required to control the bleeding (see Table 24.6).

F

Follow-up	Patients should be contacted or examined within 24 to 48 hours after surgical procedures to determine that excessive bleeding or infection is not occurring.
-----------	--

INR, International normalized ratio [INR = (PTR)^{ISI}]; ISI, international sensitivity index (based on sensitivity of thromboplastin used in PT); PT, prothrombin time; PTR, prothrombin time ratio.

days before the effect of the dose reduction is reflected in the lower INR. On the day of surgery, the INR should be checked again to determine whether the desired reduction has occurred. If no excessive bleeding occurs on the day after the dental procedure is performed, the patient's physician can direct the patient to return to his or her usual warfarin dosage.

Patients who are about to undergo major oral surgery and are receiving warfarin therapy should have input from their physician regarding the INR level that would be indicated. An INR above 3.0 may need to be adjusted by the physician. Again, it will take 3 to 5 days for any effective reduction of the INR to occur.

Another option for these patients is Coumadin–Lovenox bridging.⁸⁵⁻⁸⁷ One approach is to have the patient's physician discontinue warfarin therapy 4 days before major oral surgery and to begin a series of 30-mg subcutaneous enoxaparin (Lovenox and LMWH) injections every 12 hours (at 9 AM and 9 PM) on an outpatient basis, starting 3 days before the surgery is to be performed (referred to as Coumadin–Lovenox bridging).⁸⁸ Through discontinuation of warfarin, the INR is allowed to normalize, and enoxaparin provides anticoagulation. The last enoxaparin injection is given at 9 PM on the evening before surgery. The INR should be checked on the morning of surgery and, if within normal values (1.0), the surgery can be performed.⁸⁸ Enoxaparin injections are started again on the evening after the surgery; oral warfarin therapy is also restarted that evening. After 3 days, the postoperative enoxaparin injections are stopped.⁸⁸ A potential problem with this approach is that a temporary hypercoagulable state may occur when warfarin therapy is stopped.

The dentist must be aware that certain drugs will affect the action of warfarin (Coumadin). Drugs the dentist may use that potentiate the anticoagulant action of warfarin include acetaminophen, metronidazole, salicylates, broad-spectrum antibiotics, erythromycin, and the new COX-2-specific inhibitors (celecoxib and rofecoxib). Other drugs that have the same effect are cimetidine, chloral hydrate, phenytoin, propranolol, and thyroid drugs. Drugs that the dentist may use that will antagonize the anticoagulant action of warfarin are barbiturates, steroids, and nafcillin. Other drugs that have the same effect are carbamazepine, cholestyramine, griseofulvin, rifampin, and trazodone.⁵⁷

Postoperative pain control can be attained with the use of minimal doses of acetaminophen with or without codeine. Aspirin and NSAIDs must be avoided. When used at the indicated dosage, COX-2-specific inhibitors (celecoxib and rofecoxib) do not affect platelet count, PT, and PPT and do not inhibit platelet aggregation. However, they can increase PT and INR in patients who are taking warfarin; if used, the dosage should be reduced. With recent concerns over the possible role that COX-2 inhibitors may play in increasing the risk of myocardial infarction, it may be best to avoid these agents even though they would be used only for a short time.

Heparin Therapy. Most patients treated with standard heparin are hospitalized and will be prescribed warfarin once discharged. Dental emergencies in these patients during hospitalization should be treated as conservatively as possible, with avoidance of invasive procedures, if possible. Patients treated with hemodialysis are given heparin. The half-life of heparin is only 1 to 2 hours; thus, if they wait until the day after dialysis, these patients can receive invasive dental treatment. The dental management of these patients is presented in [Chapter 12](#).

The dentist may see patients who are being treated on an outpatient basis with an LMWH or a synthetic heparin. These agents are used in patients with recent total hip or knee replacement and those being treated on an outpatient basis for DVT or asymptomatic PE.⁸⁹ Elective surgical procedures can be delayed until the patient is taken off the LMWH or synthetic heparin, which, in most cases, will occur within 3 to 6 months. If an invasive procedure must be performed, the dentist has several options. First, the dentist should consult with the patient's physician regarding the need for and the type of surgery. The half-life of the LMWHs and fondaparinux is less than 1 day. Thus, the physician could suggest that the drug be stopped and the surgery be performed within 1 to 2 days. The other option is to go ahead with the surgery and deal with any bleeding complications on a local basis. It appears that these patients can undergo minor surgical procedures with little risk for any serious bleeding complications.^{84,90}

Direct Thrombin Inhibitors. The direct thrombin inhibitors—lepirudin, desirudin, argatroban, and bivalirudin—are injectable drugs used primarily in patients with a history of HIT. They all have very short half-lives of only several hours. The dentist is unlikely to have patients on any of these medications because they are used most often in a hospital setting. However, if the dentist has a patient taking one of these drugs, many invasive dental procedures can be done without stopping the drug. Most invasive dental procedures can be performed for patients taking the oral direct thrombin inhibitor dabigatran. Consultation with the patient's physician is recommended. Because of the short half-lives of these drugs, only 1 day would be needed without the drug for more invasive procedures.

Direct Factor Xa Inhibitors. Rivaroxaban (Xarelto) and apixaban (Eliquis) are two direct factor Xa inhibitors that are in common use. They are used primarily in patients who need anticoagulation therapy because of cancer. Patients taking these drugs will have excessive bleeding with trauma or surgical procedures.

Liver Disease. A patient with a history of jaundice or heavy alcohol use may have significant liver disease. Most coagulation factors are produced in the liver; therefore, if enough liver damage has occurred, the patient could have a serious bleeding problem because of a defect in the coagulation phase. In addition, about 50% of patients with significant liver disease (with portal hypertension present) will be thrombocytopenic as a result of sequestration of

platelets in the spleen. Alcohol also can have a direct effect on homeostasis by interfering with platelet function. The PT test can be used to screen for a defect in the coagulation phase in patients with a history that indicates liver disease (see [Chapter 10](#) for blood tests indicative of alcoholism). A platelet count should be obtained to see if the platelet phase has been affected. The amount of liver damage that has occurred may not be great enough to affect the coagulation phase, but the effect on the platelet phase could be severe enough to lead to a serious bleeding problem. If both the PT and the platelet count are normal, surgery can be performed on these patients with little risk of a postoperative bleeding problem. If results of both tests are abnormal, then the dentist should consult with the patient's physician regarding stabilization of the patient's bleeding status before surgery. Appropriate management may involve vitamin K administration, platelet replacement, or other special physician-directed procedures.

Chronic Leukemia. [Chapter 23](#) describes the dental management of patients with leukemia.

Malabsorption Syndrome or Long-Term Antibiotic Therapy. In patients with malabsorption syndrome and in those receiving long-term antibiotic therapy, bacteria in the intestine that produce vitamin K may be adversely affected. The liver needs vitamin K for the production and function of prothrombin (factor II) and related coagulation factors (factors VII, IX, and X). The PT test can be ordered to screen for a possible bleeding problem; if results are normal, surgery can be performed on these patients without risk of a bleeding problem. The patient's physician should be consulted regarding the patient's health status before surgery because complicating factors may occur in addition to the possible bleeding problem that would contraindicate surgery. Parenteral vitamin K may have to be administered in some of these cases.

End-Stage Renal Disease and Renal Dialysis. Management of patients with end-stage renal disease and those on renal dialysis is covered in [Chapter 12](#).

Vascular Wall Alteration. In patients with autoimmune disease, infectious disease, structural malformation of vessels, scurvy, steroid therapy, small vessel vasculitis, or deposits of paraproteins, alterations of the vessel wall can result in excessive bleeding after surgical procedures. No reliable screening tests can detect those patients who will be bleeders. The Ivy BT test can be used in an attempt to identify potential bleeders, but as stated earlier, this is not a reliable test. The dentist must rely on the medical history (questions related to excessive bleeding problems), clinical findings, and consultation with the patient's physician to identify these patients.

Thrombocytopenia. Patients found to have severe thrombocytopenia may require hospitalization and special preparation for surgery. A hematologist should be involved with the diagnosis, presurgical assessment, preparation, and postsurgical management of these patients.

Infiltration and block injections of local anesthesia can be provided in patients with platelet counts above 30,000/ μL . Also, most routine dental procedures can be performed. If the platelet count is below this level, routine dental treatment involving minor tissue injury should be delayed. For urgent or emergency dental needs, platelet replacement is indicated. If the platelet count is above 50,000/ μL , extractions and dentoalveolar surgery can be performed. For more advanced surgery, the platelet count should be 80,000/ μL and 100,000/ μL or higher. Patients with platelet counts below these levels will need platelet replacement before undergoing the planned procedures.^{84,91}

Two types of platelet transfusions are used in the United States. Platelet concentrates are prepared from pooled donor whole blood through centrifugation, or pheresis devices are used to provide continuous centrifugation of blood donated by a single donor, thereby providing apheresis units of concentrated platelets. These products must be used within several days or must be cryopreserved for future use. Platelets from a single donor reduce the risk of infection. Lyophilization of platelets for replacement use is being clinically tested but has not yet been approved for general use.⁹¹

The need for platelet transfusions can be reduced through the use of local measures (see [Table 24.6](#)), along with desmopressin and EACA or tranexamic acid to control bleeding. Also, topical platelet concentrates can be applied.⁸⁴

Patients who fail to respond to platelet replacement therapy have what is called *platelet transfusion refractoriness*. This may occur on an immune or a nonimmune basis. Platelet transfusion refractoriness presents management problems that are beyond the scope of this presentation. The hematologist who is involved with the patient will make recommendations on how to prepare the patient for surgical procedures.^{91,92}

Treatment Planning Modifications

With proper preparation, most indicated dental treatment can be provided for patients with various bleeding problems. Patients with bleeding problems related to diseases that may be in the terminal phase should, in general, be offered only conservative dental treatment. Aspirin and other NSAIDs should not be used for pain relief in those who have known bleeding disorders or who are receiving anticoagulant medication. Such medications include various compounds that contain aspirin, such as Anacin, Synalgos-DC, Fiorinal, Bufferin, Alka-Seltzer, Empirin with Codeine, and Excedrin. Herbal medications that may cause bleeding also should be avoided.

Oral Manifestations

Patients with bleeding disorders may experience spontaneous gingival bleeding. Oral tissues (e.g., soft palate, tongue, buccal mucosa) may show petechiae, ecchymoses, jaundice, pallor, and ulcers. Spontaneous gingival bleeding and

petechiae usually are found in patients with thrombocytopenia. Hemarthrosis of the temporomandibular joint is a rare finding in patients with coagulation disorders and is not found in patients with thrombocytopenia. Enlargement of the parotid glands may be associated with chronic liver disease that is most often seen in people with alcoholism (see Chapter 10). Patients with leukemia may exhibit generalized enlargement and bleeding of the gingiva (see Chapter 23). Patients with neoplastic disease may show osseous lesions on radiographs, as well as oral ulcers or tumors. These patients also may have drifting and loosening of teeth and may complain of paresthesias (e.g., burning of the tongue, numbness of the lip) as a result of neoplasms in the jaw (see Chapter 26).

REFERENCES

- Young A, Phillips J, Hancocks H, et al. OC-11 - Anticoagulation therapy in selected cancer patients at risk of recurrence of venous thromboembolism. *Thromb Res.* 2016;140(suppl 1):S172-S173.
- Gillinov AM, Bagiella E, Moskowitz AJ, et al. Rate control versus rhythm control for atrial fibrillation after cardiac surgery. *N Engl J Med.* 2016;374(20):1911-1921.
- Yoshimura A, Iriki Y, Ichiki H, et al. Evaluation of safety and efficacy of periprocedural use of rivaroxaban and apixaban in catheter ablation for atrial fibrillation. *J Cardiol.* 2017;69(1):228-235.
- Weitz JI, Eikelboom J. Incorporating edoxaban into the choice of anticoagulants for atrial fibrillation. *Thromb Haemost.* 2016;115(2):257-270.
- Testa S, Tripodi A, Legnani C, et al. Plasma levels of direct oral anticoagulants in real life patients with atrial fibrillation: results observed in four anticoagulation clinics. *Thromb Res.* 2016;137:178-183.
- Weeda ER, White CM, Peacock WF, et al. Rates of major bleeding with rivaroxaban in real-world studies of nonvalvular atrial fibrillation patients: a meta-analysis. *Curr Med Res Opin.* 2016;1-4.
- Welsh RC, Zeymer U, Tarrantini G. Direct oral anticoagulant use and stent thrombosis following an acute coronary syndrome: a potential new pharmacological option? *Arch Cardiovasc Dis.* 2016;109(5):359-369.
- Ariza-Sole A, Formiga F, Lorente V, et al. Efficacy of bleeding risk scores in elderly patients with acute coronary syndromes. *Rev Esp Cardiol (Engl Ed).* 2014;67(6):463-470.
- Forman DE, Goyette RE. Oral anticoagulation therapy for elderly patients with atrial fibrillation: utility of bleeding risk covariates to better understand and moderate risks. *Clin Appl Thromb Hemost.* 2014;20(1):5-15.
- Nichols WL. von Willebrand disease and hemorrhagic abnormalities of platelet and vascular function. In: Goldman L, Schafer AI, eds. *Goldman-Cecil Medicine.* 25th ed. Philadelphia, PA: Elsevier (Saunders); 2016:1163-1183.
- Ferri FF. *Ferri's Clinical Advisor.* Philadelphia, PA: Elsevier (Saunders); 2015.
- Bennett JS. Hereditary disorders of platelet function. In: Hoffman R, Furie B, McGlave P, et al, eds. *Hematology: Basic Principles and Practice.* 5th ed. Philadelphia: Churchill Livingstone, Elsevier; 2009:2133-2144.
- Lopez JA, Lockhart E. Acquired disorders of platelet function. In: Hoffman R, Furie B, McGlave P, et al, eds. *Hematology: Basic Principles and Practice.* 5th ed. Philadelphia: Churchill Livingstone, Elsevier; 2009:2145-2160.
- Arruda V, High KA. Coagulation disorders. In: Fauci AS, ed. *Harrison's Principles of Internal Medicine.* 17th ed. New York: McGraw-Hill; 2008:725-730.
- Konkle BA. Bleeding and thrombosis. In: Fauci AS, ed. *Harrison's Principles of Internal Medicine.* 17th ed. New York: McGraw-Hill; 2008:363-369.
- Baz R, Mekhail T. Bleeding disorders. In: Carey WD, ed. *Current Clinical Medicine 2009 - Cleveland Clinic.* Philadelphia: Elsevier (Saunders); 2009:669-674.
- Coller BS, Schneiderman PI. Clinical evaluation of hemorrhagic disorders: the bleeding history and differential diagnosis of purpura. In: Hoffman R, Furie B, McGlave P, et al, eds. *Hematology: Basic Principles and Practice.* 5th ed. Philadelphia: Churchill Livingstone, Elsevier; 2009:1851-1876.
- Burness CB, Scott LJ. Erratum to: Susoctocog Alfa: a review in acquired haemophilia A. *Drugs.* 2016;76(9):991.
- Chojnowski K, Robak M, Nowak W, et al. Acquired haemophilia A in a Jehovah's Witness. *Haemophilia.* 2016;22(5):e449-e451.
- Goto M, Haga N, Yokota K, et al. A successful physiotherapy management case of a patient with acquired haemophilia A prior to factor VIII inhibitor eradication. *Haemophilia.* 2016;22(3):e228-e231.
- Rossi B, Blanche P, Roussel-Robert V, et al. Rituximab as first-line therapy for acquired haemophilia A: a single-centre 10-year experience. *Haemophilia.* 2016;22(4):e338-e341.
- Tiede A, Hofbauer CJ, Werwitzke S, et al. Anti-factor VIII IgA as a potential marker of poor prognosis in acquired hemophilia A: results from the GTH-AH 01/2010 study. *Blood.* 2016;127(19):2289-2297.
- Zeng Y, Zhou R, Duan X, et al. Rituximab for eradicating inhibitors in people with acquired haemophilia A. *Cochrane Database Syst Rev.* 2016;(7):CD011907.
- Ragni MV. Hemorrhagic disorders, coagulation factor deficiencies. In: Goldman L, Schafer AI, eds. *Goldman-Cecil Medicine.* 25th ed. Philadelphia, PA: Elsevier (Saunders); 2016:30.
- Liebman HA, Weitz IC. Disseminated intravascular coagulation. In: Hoffman R, Benz EJJ, Shattil SJ, et al, eds. *Hematology Basic Principles and Practices.* 4th ed. Philadelphia: Elsevier - Churchill Livingstone; 2005:2169-2183.
- White GCI, Sadler JE. von Willebrand disease: clinical aspects and therapy. In: Hoffman R, Furie B, McGlave P, et al, eds. *Hematology: Basic Principles and Practice.* 5th ed. Philadelphia: Churchill Livingstone, Elsevier; 2009:1961-1972.

27. George JN. Drug-induced thrombocytopenia. In: Young NS, Gerson SL, High KA, eds. *Clinical Hematology*. St. Louis: Elsevier - Mosby; 2006:791-802.
28. Schauss AG. Fish oils (Omega-3 fatty acids, docosahexanoic acid, eicosapentaenoic acid, dietary fish, and fish oils). In: Pizzorno JEJ, Murray MT, eds. *Textbook of Natural Medicine*. St. Louis: Churchill Livingstone Elsevier; 2006:945-947.
29. Young A, Phillips J, Hancocks H, et al. OC-11 - Anticoagulation therapy in selected cancer patients at risk of recurrence of venous thromboembolism. *Thromb Res*. 2016;140(suppl 1):S172-S173.
30. Schafer AI. Approach to the patient with bleeding and thrombosis. In: Goldman L, Ausiello D, eds. *Cecil Medicine*. 23rd ed. Philadelphia: Saunders Elsevier; 2008:1286-1288.
31. Brass LF, et al. The molecular basis of platelet activation. In: Hoffman R, Furie B, McGlave P, eds. *Hematology: Basic Principles and Practice*. 5th ed. Philadelphia: Churchill Livingstone, Elsevier; 2009:1793-1804.
32. Karsan A, Harlan JM, et al. The blood vessel wall. In: Hoffman R, Furie B, McGlave P, eds. *Hematology: Basic Principles and Practice*. 5th ed. Philadelphia: Churchill Livingstone, Elsevier; 2009:1805-1818.
33. Furie B, Furie B, et al. Molecular basis of blood coagulation. In: Hoffman R, Furie B, McGlave P, eds. *Hematology: Basic Principles and Practice*. 5th ed. Philadelphia: Churchill Livingstone, Elsevier; 2009:1819-1836.
34. McVey JH. Coagulation factors. In: Young NS, Gerson SL, High KA, eds. *Clinical Hematology*. St. Louis: Elsevier - Mosby; 2006:103-123.
35. Ragni MV, et al. Clinical aspects and therapy of hemophilia. In: Hoffman R, Furie B, McGlave P, et al, eds. *Hematology: Basic Principles and Practice*. 5th ed. Philadelphia: Churchill Livingstone, Elsevier; 2009:1911-1930.
36. Lijnen HR, Collen D. Molecular and cellular basis of fibrinolysis. In: Hoffman R, Furie B, McGlave P, et al, eds. *Hematology: Basic Principles and Practice*. 5th ed. Philadelphia: Churchill Livingstone, Elsevier; 2009:1837-1842.
37. Bennett JS. Inherited and acquired disorders of platelet function. In: Young NS, Gerson SL, High KA, eds. *Clinical Hematology*. St. Louis: Elsevier - Mosby; 2006:767-781.
38. Brennan MT, Shariff G, Kent ML, et al. Relationship between bleeding time test and postextraction bleeding in a healthy control population. *Oral Surg Oral Med Oral Pathol Oral Radiol Endod*. 2002;94(4):439-443.
39. Watzke HH. Evaluation of the acutely bleeding patient. In: Young NS, Gerson SL, High KA, eds. *Clinical Hematology*. St. Louis: Elsevier - Mosby; 2006:1169-1179.
40. Rand JH, Senzel L. Laboratory evaluation of hemostatic disorders. In: Hoffman R, Benz EJJ, Shattil SJ, et al, eds. *Hematology Basic Principles and Practices*. 4th ed. Philadelphia: Elsevier - Churchill Livingstone; 2005:2001-2011.
41. Schmaier AH. Laboratory evaluation of hemostatic and thrombotic disorders. In: Hoffman R, Furie B, McGlave P, et al, eds. *Hematology: Basic Principles and Practice*. 5th ed. Philadelphia: Churchill Livingstone, Elsevier; 2009:1877-1884.
42. Bologna JL, Braverman IM. Skin manifestations of internal disease. In: Fauci AS, ed. *Harrison's Principles of Internal Medicine*. 17th ed. New York: McGraw-Hill; 2008:321-335.
43. Konkle BA. Disorders of platelets and vessel wall. In: Fauci AS, ed. *Harrison's Principles of Internal Medicine*. 17th ed. New York: McGraw-Hill; 2008:718-724.
44. Grandinetti LM, Tomecki KJ. Dermatologic signs of systemic disease. In: Carey WD, ed. *Current Clinical Medicine 2009 - Cleveland Clinic*. Philadelphia: Saunders Elsevier; 2009:244-256.
45. Baz R, Mekhail T. Disorders of platelet function and number. In: Carey WD, ed. *Current Clinical Medicine 2009 - Cleveland Clinic*. Philadelphia: Saunders Elsevier; 2009:669-674.
46. Toh CH. Disseminated intravascular coagulation. In: Young NS, Gerson SL, High KA, eds. *Clinical Hematology*. St. Louis: Elsevier - Mosby; 2006:1134-1155.
47. Schafer AI. Hemorrhagic disorders: disseminated intravascular coagulation, liver failure, and vitamin K deficiency. In: Goldman L, Ausiello D, eds. *Cecil Medicine*. 23rd ed. Philadelphia: Elsevier Saunders; 2008:1314-1317.
48. Liebman HA, Weitz IC. Disseminated intravascular coagulation. In: Hoffman R, Furie B, McGlave P, et al, eds. *Hematology: Basic Principles and Practice*. 5th ed. Philadelphia: Churchill Livingstone, Elsevier; 2009:1999-2009.
49. LoRusso KL, Macik BG. Chronic bruising and bleeding diathesis. In: Young NS, Gerson SL, High KA, eds. *Clinical Hematology*. St. Louis: Elsevier - Mosby; 2006:1079-1089.
50. Weitz JI. Antiplatelet, anticoagulant, and fibrinolytic drugs. In: Fauci AS, ed. *Harrison's Principles of Internal Medicine*. 17th ed. New York: McGraw-Hill; 2008:735-748.
51. Schafer AI. Thrombotic disorders: Hypercoagulable states. In: Goldman L, Ausiello D, eds. *Cecil Medicine*. 23rd ed. Philadelphia: Saunders Elsevier; 2008:1318-1323.
52. Rosendaal FR, Buller HR. Venous thrombosis. In: Fauci AS, ed. *Harrison's Principles of Internal Medicine*. 17th ed. New York: McGraw-Hill; 2008:731-734.
53. Krakow EF, et al. Arterial thromboembolism. In: Hoffman R, Furie B, McGlave P, et al, eds. *Hematology: Basic Principles and Practice*. 5th ed. Philadelphia: Churchill Livingstone, Elsevier; 2009:2055-2066.
54. Lim W, et al. Venous thromboembolism. In: Hoffman R, Furie B, McGlave P, et al, eds. *Hematology: Basic Principles and Practice*. 5th ed. Philadelphia: Churchill Livingstone, Elsevier; 2009:2043-2054.
55. Wells PS, Theberge IA, Bowdridge JC, et al. PO-41 - Rivaroxaban is effective therapy for high risk cancer patients with venous thromboembolic disease. *Thromb Res*. 2016;140(suppl 1):S191-S192.
56. Hirsh J, Schulman S. Antithrombotic therapy. In: Goldman L, Ausiello D, eds. *Cecil Medicine*. 23rd ed. Philadelphia: Saunders Elsevier; 2008:197-205.

57. Weitz IC. Antithrombotic drugs. In: Hoffman R, Furie B, McGlave P, et al, eds. *Hematology: Basic Principles and Practice*. 5th ed. Philadelphia: Churchill Livingstone, Elsevier; 2009:2067-2082.
58. Peacock WF, Levy PD, Gonzalez MG, et al. Target-specific oral anticoagulants in the emergency department. *J Emerg Med*. 2016;50(2):246-257.
59. Pujol C, Niesert AC, Engelhardt A, et al. Usefulness of direct oral anticoagulants in adult congenital heart disease. *Am J Cardiol*. 2016;117(3):450-455.
60. Rostagno C. New oral anticoagulants in prophylaxis of venous thromboembolic disease in major orthopedic surgery. *Cardiovasc Hematol Disord Drug Targets*. 2016;15(3):204-209.
61. Elliott G. *Concise Review: Low-Molecular-Weight Heparin in the Treatment of Acute Pulmonary Embolism*. New York: McGraw-Hill; 2000. <http://www.harrissononline.com>. Accessed 15 December 2000 2000.
62. Warkentin TE, Crowther MA. Anticoagulant and thrombolytic therapy. In: Young NS, Gerson SL, High KA, eds. *Clinical Hematology*. St. Louis: Elsevier - Mosby; 2006:1114-1134.
63. Verdecchia P, Angeli F, Aita A, et al. Why switch from warfarin to NOACs? *Intern Emerg Med*. 2016;11(3):289-293.
64. Uprichard J. Management of rivaroxaban in relation to bodyweight and body mass index. *Ther Adv Cardiovasc Dis*. 2016;10(5):294-303.
65. Wolosker N, Varella AY, Fukuda JM, et al. Enoxaparin treatment followed by rivaroxaban for the treatment of acute lower limb venous thromboembolism: initial experience in a single center. *Clin Appl Thromb Hemost*. 2016;22(4):377-380.
66. Wang KL, Chu PH, Lee CH, et al. Management of venous thromboembolisms: Part I. The consensus for deep vein thrombosis. *Acta Cardiol Sin*. 2016; 32(1):1-22.
67. Vargas M, Marra A, Perrone A, et al. Bleeding management in patients on new oral anticoagulants. *Minerva Anesthesiol*. 2016;82(8):884-894.
68. Toth PP. Considerations for long-term anticoagulant therapy in patients with venous thromboembolism in the novel oral anticoagulant era. *Vasc Health Risk Manag*. 2016;12:23-34.
69. Collier BS, Schneiderman PI. Clinical evaluation of hemorrhagic disorders: the bleeding history and differential diagnosis of purpura. In: Hoffman R, Benz EJJ, Shattil SJ, et al, eds. *Hematology Basic Principles and Practices*. 4th ed. Philadelphia: Elsevier - Churchill Livingstone; 2005:1975-2001.
70. Grines CL, Bonow RO, Casey DEJ, et al. Prevention of premature discontinuation of dual antiplatelet therapy in patients with coronary artery stents: a science advisory from the American Heart Association, American College of Cardiology, Society for Cardiovascular Angiography and Interventions, American College of Surgeons, and American Dental Association, with representation from the American College of Physicians. *J Am Dent Assoc*. 2007;138(5):652-655.
71. Fitzgerald GA. Prostaglandins, aspirin, and related compounds. In: Goldman L, Ausiello D, eds. *Cecil Medicine*. 23rd ed. Philadelphia: Saunders Elsevier; 2008:189-196.
72. Napeñas JJ, Hong CHL, Brennan MT, et al. The frequency of bleeding complications after invasive dental treatment in patients receiving single and dual antiplatelet therapy. *J Am Dent Assoc*. 2009;140(6): 690-695.
73. Weitz JI. New oral anticoagulants in development. *Thromb Haemost*. 2009;103(1):62-70.
74. Wahl M. Dental surgery in anticoagulated patients. *Arch Intern Med*. 1998;158:1610-1616.
75. Wahl MJ. Myths of dental surgery in patients receiving anticoagulant therapy. *J Am Dent Assoc*. 2000;131(1):77-81.
76. Blinder D, Manor Y, Martinowitz U, et al. Dental extractions in patients maintained on oral anticoagulant therapy: comparison of INR value with occurrence of postoperative bleeding. *Int J Oral Maxillofac Surg*. 2001;30(6):518-521.
77. Hirsh J, Fuster V, Ansell J, et al. American Heart Association/American College of Cardiology Foundation guide to warfarin therapy. *J Am Coll Cardiol*. 2003;41(9):1633-1652.
78. Zanon E, Martinelli F, Bacci C, et al. Safety of dental extraction among consecutive patients on oral anticoagulant treatment managed using a specific dental management protocol. *Blood Coagul Fibrinolysis*. 2003;14(1):27-30.
79. Akopov S. Withdrawal of warfarin prior to a surgical procedure: time to follow the guidelines? *Cerebrovasc Dis*. 2005;19(5):337-342.
80. Ansell J, Hirsh J, Dalen J, et al. Managing oral anticoagulant therapy. *Chest*. 2001;119(1 suppl):22S-38S.
81. Bussey HI. Should I stop my patient's warfarin prior to a dental procedure? 2005. <http://www.clotcare.com>. Accessed 10 May 2006 2006.
82. Federici AB, Sacco R, Stabile F, et al. Optimising local therapy during oral surgery in patients with von Willebrand disease: effective results from a retrospective analysis of 63 cases. *Haemophilia*. 2000;6(2):71-77.
83. Zanon E, Martinelli F, Bacci C, et al. Proposal of a standard approach to dental extraction in haemophilia patients. A case-control study with good results. *Haemophilia*. 2000;6(5):533-536.
84. Scully C, Cawson RA. *Medical Problems in Dentistry*. 5th ed. Edinburgh: Elsevier; 2005.
85. Bajkin B, Popovic S, Selakovic S. Randomized, prospective trial comparing bridging therapy using low-molecular-weight heparin with maintenance of oral anticoagulation during extraction of teeth. *J Oral Maxillofac Surg*. 2009;67:990-995.
86. Brejcha M, Gumulec J, Penka M, et al. Preparation of patients on anticoagulant treatment for invasive surgery. *Vnitř Lek*. 2009;55:272-275.
87. Ahmed I, Gertner E, Nelson WB, et al. Continuing warfarin therapy is superior to interrupting warfarin with or without bridging anticoagulation therapy in patients undergoing pacemaker and defibrillator implantation. *Heart Rhythm*. 2010;7:745-749.
88. Johnson-Leong C, Rada RE. The use of low-molecular-weight heparins in outpatient oral surgery for patients

- receiving anticoagulation therapy. *J Am Dent Assoc.* 2002;133(8):1083-1087.
89. Vallakati A, Sharma A, Madmani M, et al. Efficacy and safety of novel oral anticoagulants for atrial fibrillation ablation: an updated meta-analysis. *Cardiol Ther.* 2016; 5(1):85-100.
90. Little JW, Miller CS, Henry RG, et al. Antithrombotic agents: implications in dentistry. *Oral Surg Oral Med Oral Pathol Oral Radiol Endod.* 2002;93(5):544-551.
91. Kickler TS. Principles of platelet transfusion therapy. In: Hoffman R, Benz EJJ, Shattil SJ, et al, eds. *Hematology Basic Principles and Practices.* 4th ed. Philadelphia: Elsevier - Churchill Livingstone; 2005:2433-2441.
92. Shuman M. Hemorrhagic disorders: abnormalities of platelet and vascular function. In: Goldman L, Ausiello D, eds. *Cecil Textbook of Medicine.* Philadelphia Saunders: 2004:1060-1069.

Congenital Bleeding and Hypercoagulable Disorders

A number of procedures that are performed in dentistry may cause bleeding. Under normal circumstances, these procedures can be performed with little risk; however, patients whose ability to control bleeding is altered by congenital defects in coagulation factors, platelets, or blood vessels may be in grave danger unless the dentist identifies the problem before performing any dental procedure. In most cases, after a patient with a congenital bleeding problem has been identified, steps can be taken to greatly reduce the risks associated with dental procedures. The following disorders are discussed in this chapter: hereditary hemorrhagic telangiectasia (Osler-Weber-Rendu syndrome), von Willebrand disease, Bernard-Soulier disease, Glanzmann thrombasthenia, hemophilia A, hemophilia B (Christmas disease), and congenital hypercoagulability disorders.

Inherited (congenital) bleeding disorders are genetically transmitted. They may involve a deficiency of one of the coagulation factors, abnormal construction of platelets, deficiency of von Willebrand factor, or malformation of vessels (Box 25.1). They are not as prevalent as acquired bleeding disorders. In a typical dental practice of 2000 patients, at the most 10 to 20 patients will have a congenital bleeding disorder. Inherited hypercoagulability disorders increase the risk for thromboembolism caused by a genetic deficiency of an antithrombotic factor or increasing a prothrombotic factor. They are more common than the inherited bleeding disorders.

COMPLICATIONS: Patients who have congenital bleeding disorders can be at risk for epistaxis, easy bruising, skin and mucous membrane bleeding, menorrhagia, gingival bleeding, hemarthrosis, dissecting hematomas, petechiae and ecchymoses, and in some cases gastrointestinal (GI) bleeding. In hereditary telangiectasia, skin and mucosal lesions and in one form, pulmonary arterial venous malformations, stroke, and cerebral abscesses may occur. In type 3 von Willebrand disease, there is a lack of factor VIII and spontaneous epistaxis, and oral mucosal bleeding may occur. The result may be severe hemorrhage and death.

EPIDEMIOLOGY

The most common inherited bleeding disorder is von Willebrand disease.¹ It affects about 1% of the U.S.

population. The disease usually is inherited as an autosomal dominant trait.¹ Hemophilia A, factor VIII deficiency, is the most common of the inherited coagulation bleeding disorders.² It occurs in about 1 of every 5000 male births. More than 20,000 individuals in the United States have hemophilia A,^{3,4} and worldwide about 400,000 patients have severe hemophilia.² Because of its genetic mode of transfer, certain areas of the United States contain higher concentrations of people with hemophilia. Hemophilia B (Christmas disease), a factor IX deficiency, is found in about 1 of every 30,000 male births.⁴ About 80% of all genetic coagulation disorders are hemophilia A, 13% are hemophilia B, and 6% are factor XI deficiency.⁴ Bernard-Soulier disease and Glanzmann thrombasthenia are rare inherited platelet disorders.^{1,5} Hereditary hemorrhagic telangiectasia (HHT) is a rare (1:8000 to 1:50,000) vascular disorder.⁶ Ehlers-Danlos disease, osteogenesis imperfecta, pseudoxanthoma elasticum, and Marfan syndrome are rare hereditary connective tissue disorders that may be associated with bleeding problems but are not covered in this chapter.¹ An inherited hypercoagulable state has been reported in more than 60% of patients presenting with idiopathic venothromboembolism.⁷

Etiology

Patients may be born with a deficiency of one of the factors needed for blood coagulation—for example, factor VIII deficiency as in hemophilia A or factor IX deficiency as in hemophilia B or Christmas disease. Congenital deficiencies of the other coagulation factors have been reported but are rare (Table 25.1). When congenital deficiency of a coagulation factor occurs, only a single factor is affected.^{4,8}

In von Willebrand disease, the primary problem involves lack of various sizes of von Willebrand factor (vWF), which are needed to attach platelets to damaged vascular wall tissues and to carry factor VIII in circulation.^{1,9} In the most severe form of the disease, bleeding occurs as a consequence of lack of platelet adhesion and deficiency of factor VIII.¹ Bernard-Soulier disease is a disorder of platelet adhesion to vWF caused by a lack of glycoprotein (GP) Ib on the platelet membrane.^{1,6} These platelets are unable to bind to vWF and thus are unable to adhere to the subendothelium. Glanzmann thrombasthenia is a disorder of platelet aggregation due to abnormality of

BOX 25.1 Classification of Congenital Bleeding and Thrombotic Disorders

Nonthrombocytopenic Purpuras

Vascular Wall Alterations

Hereditary hemorrhagic telangiectasia

Disorders of Platelet Function

von Willebrand disease (may have secondary factor VIII deficiency)

Bernard-Soulier disease*

Glanzmann thrombasthenia

Others

Thrombocytopenic Purpuras (All Are Very Rare)

Gray platelet syndrome

May-Hegglin anomaly

Hereditary thrombocytopenia, deafness, and renal disease

Fechtner syndrome

Alport syndrome

Sebastian platelet syndrome

Others

Disorders of Coagulation

Hemophilia A (factor VIII deficiency)

Hemophilia B (factor IX deficiency)

Other coagulation factor deficiencies

Hypercoagulable States

Antithrombin III deficiency

Protein C deficiency

Protein S deficiency

Factor V Leiden mutation

Prothrombin G2021A mutation

Hyperhomocysteinemia

*Bernard-Soulier disease also has been classified as a thrombocytopenic disorder.

the platelet membrane complex GP IIb/IIIa.^{1,6} The platelets can adhere to the subendothelium but cannot bind to fibrinogen.

Hereditary hemorrhagic telangiectasia is a disorder consisting of multiple telangiectatic lesions involving the skin and mucous membranes.⁶ Bleeding occurs because of the inherent mechanical fragility of the affected vessels. Problems with the construction of connective tissue components of the vessel wall are the underlying weakness in Ehlers-Danlos disease, osteogenesis imperfecta, pseudoxanthoma elasticum, and Marfan syndrome.^{6,10} Readers are referred to other sources for further information on these latter diseases.

Pathophysiology and Complications

The three phases of hemostasis for controlling bleeding are vascular, platelet, and coagulation. The vascular and platelet phases are referred to as primary, and the

coagulation phase is secondary. The coagulation phase is followed by the fibrinolytic phase, during which the clot is dissolved. These hemostatic mechanisms are discussed in detail in [Chapter 24](#), on acquired bleeding disorders.

CLINICAL PRESENTATION

Signs and Symptoms

The most common objective findings in patients with genetic coagulation disorders are ecchymoses, hemarthrosis, and dissecting hematomas ([Figs. 25.1](#) and [25.2](#)).^{4,8,11} The signs seen most commonly in patients with abnormal platelets or thrombocytopenia are petechiae and ecchymoses ([Fig. 25.3](#)).^{3,12,13} The signs seen most commonly in patients with vascular defects are petechiae and bleeding from the skin or mucous membrane.⁶

Laboratory and Diagnostic Findings

Three tests are recommended for use in initial screening for possible bleeding disorders:¹⁴⁻¹⁶ activated partial thromboplastin time (aPTT), prothrombin time (PT), and platelet count ([Fig. 25.4](#)). If no clues are evident as to the cause of the bleeding problem and the dentist is ordering the tests through a commercial laboratory, an additional test can be added to the initial screen: thrombin time (TT).¹⁴⁻¹⁶

Patients with positive results on screening tests should be evaluated further so that the specific deficiency can be identified and the presence of inhibitors ruled out. A hematologist orders these tests, establishes a diagnosis that is based on the additional testing, and makes recommendations for treatment of the patient who is found to have a significant bleeding problem. The screening laboratory tests are discussed in detail in [Chapter 24](#).

In patients with prolonged aPTT, PT, and TT, the defect involves the last stage of the common pathway, which is the activation of fibrinogen to form fibrin to stabilize the clot. The plasma level of fibrinogen is determined, and if it is within normal limits, then tests for fibrinolysis are performed. These tests, which detect the presence of fibrinogen, fibrin degradation products, or both, consist of staphylococcal clumping assay, agglutination of latex particles coated with antifibrinogen antibody, and euglobulin clot lysis time.¹⁴⁻¹⁶

MEDICAL MANAGEMENT

Congenital conditions that may cause clinical bleeding are considered. Emphasis is placed on identification of patients with a potential bleeding problem and management of these patients if surgical procedures are needed.

[Table 25.2](#) summarizes the nature of the defects and the medical treatment available for excessive bleeding in patients with the disorders covered in this section. [Tables 25.3](#) and [25.4](#) list commercial products that are available to treat bleeding problems in these disorders.

TABLE 25.1 Blood Coagulation Components

Factor	Deficiency	Function
Factor II (prothrombin)	Congenital—rare	Protease zymogen
Factor X	Congenital—rare	Protease zymogen
Factor IX	Congenital—rare	Protease zymogen
Factor VII	Congenital—very rare	Protease zymogen
Factor VIII	Congenital—more common	Cofactor
Factor V	Congenital—rare	Cofactor
Factor XI	Congenital—rare	Protease zymogen
Factor XII	Deficiency reported but does not cause bleeding; aPTT will be prolonged	Protease zymogen
Factor I (fibrinogen)	Congenital—rare	Structural
von Willebrand factor	Congenital—most common	Adhesion
Tissue factor	Not applicable	Cofactor initiator
Factor XIII	Congenital—rare; will cause bleeding, but aPTT and PT will be normal	Fibrin stabilization
High-molecular-weight kininogen	Deficiency does not cause bleeding; will prolong aPTT	Coenzyme
Prekallikrein	Deficiency does not cause bleeding; will prolong aPTT	Coenzyme

aPTT, Activated partial thromboplastin time; PT, prothrombin time.

Data from McVey JH: Coagulation factors. In Young NS, Gerson SL, High KA, editors: *Clinical hematology*, St. Louis, 2006, Mosby.



FIG 25.1 Large area of subcutaneous ecchymoses caused by trauma in a patient with hemophilia. (From Hoffbrand AV, Pettit JE: *Color atlas of clinical hematology*, ed 4, London, 2010, Mosby.)



FIG 25.2 Acute hemarthrosis of the knee is a common complication of hemophilia. It may be confused with acute infection unless the patient's coagulation disorder is known because the knee is hot, red, swollen, and painful. (From Forbes CD, Jackson WF: *Color atlas and text of clinical medicine*, ed 3, London, 2003, Mosby.)

Vascular Defects

Hereditary hemorrhagic telangiectasia, also referred to as Osler-Weber-Rendu syndrome, is a rare autosomal dominant disorder that is characterized by multiple telangiectatic lesions involving the skin, mucous membranes, and viscera. One form of the disorder, characterized by a high frequency of symptomatic pulmonary arteriovenous malformations and cerebral abscesses, has been identified. Both ENG and ALK-1 encode putative receptors for transforming growth factor-beta (TGF- β) superfamily that play a critical role for proper development of the blood vessels.¹⁷

The telangiectasias consist of focal dilation of postcapillary venules with connections to dilated arterioles, initially through capillaries and later directly. Perivascular mononuclear cell infiltrates also are observed. The vessels of HHT show a discontinuous endothelium and an incomplete smooth muscle cell layer. The surrounding stroma lacks elastin. Thus, the bleeding tendencies are thought to be because of mechanical fragility of the abnormal vessels.⁶ Lesions usually appear in affected persons by the age of 40 years, and they increase in number with age.^{6,18-21}

Clinical Findings. On clinical examination, venous lakes and papular, punctate, matlike, and linear telangiectasias appear on all areas of the skin and mucous membranes, with a predominance of lesions on and under the tongue



FIG 25.3 Purpura (petechiae), in this case, thrombocytopenia purpura. The patient was a 15-year-old boy whose antiepileptic treatment regimen had recently been modified to include sodium valproate. This is just one of a number of drugs that may induce thrombocytopenia purpura, but the disorder is almost always reversible if the drug therapy is stopped. (From Forbes CD, Jackson WF: *Color atlas and text of clinical medicine*, ed 3, London, 2003, Mosby.)

and on the face, lips, perioral region, nasal mucosa, fingertips, toes, and trunk.⁶ Recurrent epistaxis is a common finding in patients with this disorder; symptoms tend to worsen with age. Thus, the severity of the disorder often can be gauged by the age at which the nosebleeds begin, with the most severely affected patients experiencing recurrent epistaxis during childhood. Cutaneous changes usually begin at puberty and progress throughout life. Bleeding can occur in virtually every organ, with GI, oral, and urogenital sites most commonly affected (Fig. 25.5). In the GI tract, the stomach and duodenum are more frequent sites of bleeding than is the colon. Other features may include hepatic and splenic arteriovenous shunts, as well as intracranial, aortic, and splenic aneurysms. Pulmonary arteriovenous fistulas are associated with oxygen desaturation, hemoptysis, hemothorax, brain abscess, and cerebral ischemia caused by paradoxical emboli. Cirrhosis of the liver has been reported in some families.^{6,20,21}

Laboratory and Diagnostic Findings

The diagnosis is based on clinical (Curacao) criteria; there are no reliable laboratory tests to determine the tendency for bleeding to occur in affected persons. Clinical findings and a history of bleeding problems are the only effective means to identify patients at risk.

MEDICAL MANAGEMENT

Therapy for HHT remains fragmented and problematic, consisting of laser treatment for cutaneous lesions; split-thickness skin grafting, embolization of arteriovenous communications, or hormonal therapy (estrogen or estrogens plus progesterone) for epistaxis; pulmonary resection or embolization for pulmonary arteriovenous malformations; and hormonal therapy and laser coagulation for GI lesions.⁶

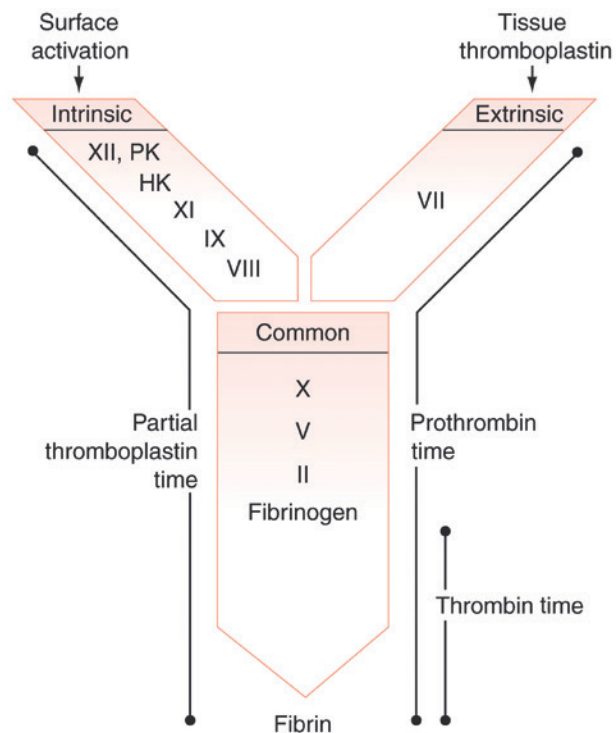

FIG 25.4 Organization of the coagulation system based on current screening assays. The intrinsic coagulation system consists of the protein factors XII, XI, IX, and VIII; prekallikrein (PK); and high-molecular-weight kininogen (HK). The extrinsic coagulation system consists of tissue factor and factor VII. The common pathway of the coagulation system consists of factors X, V, and II and fibrinogen (I). The activated partial thromboplastin time requires the presence of every protein except tissue factor and factor VII. The prothrombin time requires tissue factor; factors VII, X, V, and II; and fibrinogen. The thrombin clotting time only tests the integrity of fibrinogen. (From McPherson RA, Pincus MR, editors: *Henry's clinical diagnosis and management by laboratory methods*, ed 22, London, 2012, Saunders.)

Estrogen or progesterone treatment has been advised, but no benefit has been demonstrated in a placebo-controlled randomized trial.²⁰ Treatment with thalidomide can reduce the severity and frequency of nosebleeds (epistaxis) in subjects with HHT.²²

The nasal vasculature pattern may help to predict the response to laser therapy versus septodermoplasty. Resurfacing the nasomaxillary cavity with radial forearm fasciocutaneous free flaps has been reported to be effective in patients with refractory epistaxis. The antifibrinolytic agents aminocaproic acid and tranexamic acid have been reported to be beneficial in controlling hemorrhage, but negative results with antifibrinolytic therapy also have been reported. Improvement in lesions has been reported in cases using an antagonist to vascular endothelial growth factor and sirolimus and aspirin. Patients with GI bleeding should receive supplemental iron and folate; red blood cell transfusions and parenteral iron may be required in some patients.^{6,20,21}

TABLE 25.2 Medical Treatment of Congenital Bleeding Disorders

Condition	Defect	Medical Management
Hereditary hemorrhagic telangiectasia	Multiple telangiectasias with mechanical fragility of the abnormal vessels	Laser Surgery Estrogen Estrogen plus progesterone Thalidomide
von Willebrand disease	Deficiency or defect in vWF causing poor platelet adhesion and in some cases deficiency of factor VIII	Desmopressin Aminocaproic acid Factor VIII replacement that retains vWF
Hemophilia A	Deficiency or defect in factor VIII	Desmopressin Aminocaproic acid Factor VIII
Hemophilia B	Some patients develop antibodies (inhibitors) to factor VIII	Porcine factor VIII, PCC, aPCC, factor VIIa, and/or steroids for patients with inhibitors
	Deficiency or defect in factor IX	Desmopressin Aminocaproic acid Factor IX
Bernard-Soulier disease	Development of antibodies (inhibitors) to factor IX is much less common than with hemophilia A	PCC, aPCC, factor VIIa,* and/or steroids for patients with inhibitors
	Genetic defect in platelet membrane, absence of GP Ib causes disorder in platelet adhesion	Platelet transfusion Desmopressin Factor VIIa
Glanzmann thrombasthenia	Genetic defect in platelet membrane, absence of GP IIb/IIIa	Platelet transfusion Desmopressin Factor VIIa

*Factor VIIa is activated factor VII.

aPCC, Activated prothrombin complex concentrates; GP, glycoprotein; PCC, prothrombin complex concentrates; vWF, von Willebrand factor.

TABLE 25.3 Food and Drug Administration–Approved Clotting Concentrates for Hemophilia A and B

Preparation With Virucidal Technique(s)	Type (Manufacturer)	Specific Activity (IU/mg Protein)
ULTRAPURE RECOMBINANT FACTOR VIII		
Immunoaffinity; ion exchange chromatography	Recombinate (Baxter)	>4000
Ion exchange chromatography, nanofiltration	Refacto (Wyeth)	11,200–15,000
Ion exchange chromatography, ultrafiltration	Kogenate FS (Bayer)	>4000
No human or animal protein used in culture; immunoaffinity and ion exchange chromatography	Advate (Baxter)	>4000–10,000
ULTRAPURE HUMAN PLASMA FACTOR VIII		
Chromatography and pasteurization	Monoclote P (ZLB Behring)	>3000
Chromatography and solvent detergent	Hemofil M (Baxter)	>3000
HIGH-PURITY HUMAN PLASMA FACTOR VIII		
Chromatography, solvent detergent, dry heating	Alphanate SD (Grifols) vWF	50–>400
Solvent detergent, dry heating	Koate-DVI (Bayer) vWF	50–100
Pasteurization (heating in solution)	Humate-P (ZLB-Behring) vWF	1–10
PORCINE PLASMA-DERIVED FACTOR VIII		
Solvent detergent viral attenuation	Hyate-C (Ibsen/Biomeasure)	>50
ULTRAPURE RECOMBINANT FACTOR IX		
Affinity chromatography and ultrafiltration	BeneFix (Wyeth)	>200
Very highly purified plasma factor IX		
Chromatography and solvent detergent	AlphaNine SD (Grifols)	>200
Monoclonal antibody ultrafiltration	Mononine (ZLB-Behring)	>160

Continued

TABLE 25.3 Food and Drug Administration–Approved Clotting Concentrates for Hemophilia A and B—cont'd

Preparation With Virucidal Technique(s)	Type (Manufacturer)	Specific Activity (IU/mg Protein)
LOW-PURITY PLASMA FACTOR IX COMPLEX		
Solvent detergent	Profilnine SD (Grifols)	<50
Vapor heat	Bebulin VH (Baxter)	<50
ACTIVATED PLASMA FACTOR IX COMPLEX CONCENTRATE (USED PRIMARILY FOR PATIENTS WITH ALLOANTIBODY AND AUTOANTIBODY FACTOR VIII AND IX INHIBITOR)		
Vapor heat	FEIBA VH (Baxter)	<50
RECOMBINATE FACTOR VIIA (INDICATED FOR PATIENTS WITH ALLOANTIBODY AND AUTOANTIBODY FACTOR VIII AND IX INHIBITORS)		
Affinity chromatography, solvent detergent	NovoSeven (Novo Nordis)	50,000

vWF, von Willebrand factor.

Data from Kessler CM: Hemorrhagic disorders: coagulation factor deficiencies. In Goldman L, Ausiello D, editors: *Cecil medicine*, ed 23, Philadelphia, 2008, Saunders.

TABLE 25.4 Food and Drug Administration–Approved Coagulation Proteins and Replacement Therapies Available in the United States

Deficiency	Inheritance	Prevalence	Minimum Hemostatic Level	Replacement Source(s)
Factor I			50–100 mg	Cryoprecipitate/FFP
Afibrinogenemia	Autosomal R	Rare; <300 families		
Dysfibrinogenemia	Autosomal D or R	Rare; >variants		
Factor II (prothrombin)	Autosomal D or R	Rare; 25 kindreds	30% normal	FFP, factor IX complex
Factor V (labile factor)	Autosomal R	1/1 million births	25% normal	FFP
Factor VII	Autosomal R	1/500,000 births	25% normal	Recombinant factor VIIa
Factor VIII (antihemophilic factor)	X-linked R	1/5000 births	25.30% for minor bleeds, 50% for serious bleeds, 80%–100% for surgery or life-threatening bleeds	Factor VIII concentrates
von Willebrand disease				
Types 1 and 2	Autosomal D	1% prevalence	>50% vWF	Desmopressin
Type 3	Autosomal R	1/1 million births	>50% vWF	Factor VIII concentrate with vWF
Factor IX (Christmas factor)	X-linked R	1/30,000 births	25%–50% normal	Factor IX complex concentrates
Factor X (Stuart-Prower factor)	Autosomal R	1/500,000 births	10%–25% normal	FFP or factor IX complex concentrates
Factor XI (hemophilia C)	Autosomal D, severe type R	4% Ashkenazi Jews; 1/1 million in general population	20%–40% normal	FFP or factor IX concentrate
Factor XII (Hageman factor)	Autosomal R	Not available	No treatment necessary	
Factor XIII (fibrin-stabilizing factor)	Autosomal R	1/3 million births	5% of normal	FFP, cryoprecipitate or virus-attenuated factor XIII concentrate

D, Dominant; FFP, fresh-frozen plasma; R, recessive; vWF, von Willebrand factor.

From Kessler CM: Hemorrhagic disorders: coagulation factor deficiencies. In Goldman L, Ausiello D, editors: *Cecil medicine*, ed 23, Philadelphia, 2008, Saunders.

PLATELET DISORDERS

VON WILLEBRAND DISEASE

The most common inherited bleeding disorder is von Willebrand disease, which is caused by an inherited defect

involving platelet adhesion.¹ The vWF gene and protein and points of mutation are shown in Fig. 25.6. The cause of platelet dysfunction in von Willebrand disease is a deficiency or a qualitative defect in vWF, which is made from a group of GPs produced by megakaryocytes and endothelial cells. They are formed into a single monomer

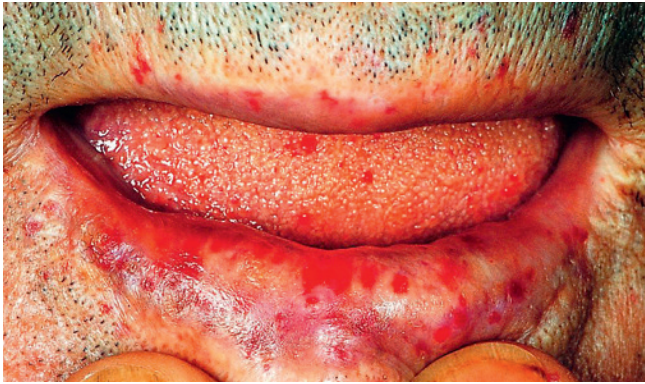

FIG 25.5 Hereditary hemorrhagic telangiectasia (HHT). HHT is a condition in which occult blood loss in the gut may lead to severe iron deficiency anemia. The diagnosis usually is clear from a careful clinical examination, although the telangiectases are not always as obvious, as in this patient with multiple lesions on the face, lip, and tongue. The patient had received multiple blood transfusions over many years because of HHT-associated gastrointestinal blood loss, and he had developed cirrhosis associated with hepatitis B antigen positivity, probably as a result of transmission of hepatitis B in transfused blood. (From Forbes CD, Jackson WF: *Color atlas and text of clinical medicine*, ed 3, London, 2003, Mosby.)

that polymerizes into huge complexes, which are needed to carry (bind) factor VIII and to allow platelets to adhere to surfaces. Unbound factor VIII is destroyed in the circulation.^{3,9,12,13}

The disease has several variants, depending on the severity of genetic expression (Table 25.5). Most of the variants are transmitted as autosomal dominant traits (types 1 and 2). These variants of the disease tend to result in mild to moderate clinical bleeding problems. Type 1 is the most common form of von Willebrand disease. It accounts for about 70% to 80% of the cases.¹ The greater the deficiency of vWF in type 1 disease, the more likely it is that signs and symptoms of hemophilia A will be found.¹ Type 2A is responsible for 15% to 20% of cases. The other variants of the disease are uncommon.^{1,8} Type 3, which is rare, is transmitted as an autosomal recessive trait that leads to severe deficiency of vWF and FVIII.^{1,3,9,12,13} Variants of von Willebrand disease with a significant reduction in vWF or with a vWF that is unable to bind factor VIII may show signs and symptoms of hemophilia A, in addition to those associated with defective platelet adhesion.¹ In mild cases, bleeding occurs only after surgery or trauma. In the more severe cases—type 2N and type 3—spontaneous epistaxis or oral mucosal bleeding may be noted.^{1,3,9,12,13}

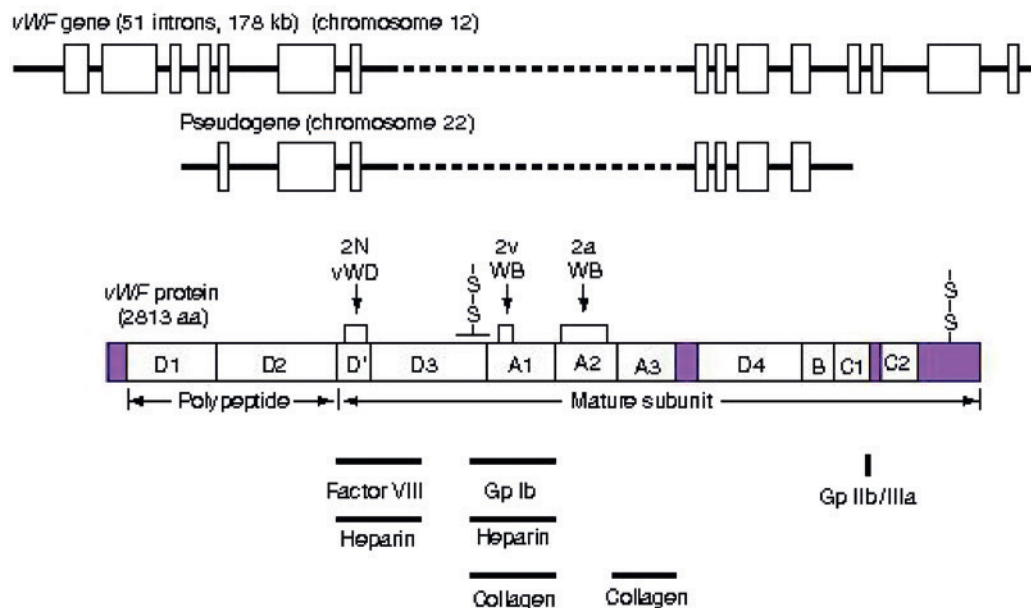

FIG 25.6 The structure of the von Willebrand factor (vWF) gene and protein. The structures of the vWF gene and pseudogene are indicated schematically at the top of the figure. The corresponding protein also is depicted, including the homologous repeat domain structure. The localization within vWF of point mutations associated with von Willebrand disease (vWD) variants also is indicated. AA, Amino acids; GP, glycoprotein. (From Hoffman R, Furie B, McGlave P, et al, editors: *Hematology: basic principles and practice*, ed 5, Philadelphia, 2009, Churchill Livingstone.)

TABLE 25.5 Multimeric Patterns of von Willebrand Disease and Laboratory Diagnosis by Type

Type	Multimeric Pattern	Ristocetin Cofactor Activity	Factor VIII Activity	High-Molecular-Weight vWF Multimers	Ristocetin-Induced Platelet Aggregation
1 (classic)	Uniform reduced in all	Mildly decreased	Moderately decreased	Normal	Mildly decreased or normal
2A	Reduced in large and intermediate multimers	Moderately decreased	Mildly decreased or normal	Moderately decreased	Mildly decreased
2B	Reduced in large multimers	Moderately decreased	Mildly decreased or normal	Mildly decreased	Increased
2M	Mildly decreased or normal	Mildly decreased	Mildly decreased or normal	Normal	Mildly decreased
2N	Normal	Normal	Moderately decreased	Normal	Normal
3	Absent	Markedly decreased	Markedly decreased	Markedly decreased or absent	Markedly decreased

vWF, von Willebrand factor.

Data from Kessler CM: Hemorrhagic disorders: coagulation factor deficiencies. In Goldman L, Ausiello D, editors: *Cecil medicine*, ed 23, Philadelphia, Saunders, 2008, pp 1301-1313 and Baz R, Mekhail T: Disorders of platelet function and number. In Carey WD, et al, editors: *Current clinical medicine* 2009—Cleveland Clinic, Philadelphia, 2009, Saunders.

Clinical Presentation

Signs and Symptoms. Mild variants of von Willebrand disease are characterized by a history of cutaneous and mucosal bleeding because platelet adhesion is lacking. In the more severe forms of the disease, in which factor VIII levels are low, hemarthroses and dissecting intramuscular hematomas are part of the clinical picture. Petechiae are rare in these patients. However, GI bleeding, epistaxis, and menorrhagia are very common. Fig. 25.7 shows the sites and frequency of bleeding in patients with type 1 von Willebrand disease. Serious bleeding can occur in these patients after trauma or surgical procedures. Patients with more severe forms of the disease may describe a family history of bleeding and report having had problems with bleeding after injury or surgery. Patients with mild forms of the disease may have a negative history for bleeding problems.¹

Laboratory and Diagnostic Findings. Laboratory investigation is needed to make the diagnosis. Screening laboratory tests may show prolonged aPTT, normal or slightly reduced platelet count, normal PT, and normal TT. Additional laboratory tests are needed to establish the diagnosis and type of von Willebrand disease. These consist of ristocetin cofactor activity, ristocetin-induced platelet aggregation, immunoassay of vWF, multimeric analysis of vWF, and specific assays for factor VIII.^{1,3,9,12,13}

Medical Management

Treatment depends on the clinical condition of the patient and the type of von Willebrand disease that is diagnosed.¹ Available treatment options include cryoprecipitate, factor VIII concentrates that retain HMW vWF multimers (Humate-P, Koate HS), and desmopressin (1-deamino-8-D-arginine vasopressin [DDAVP]).¹ Before desmopressin is given, the patient must be tested for response to the agent

as some patients are nonresponsive. Desmopressin can be given parenterally or by nasal spray 1 hour before surgery. With parenteral administration, the dose of desmopressin is 0.3 µg/kg of body weight, with a maximum dose of 20 to 24 µg.¹ The nasal spray, Stimate, contains 1.5 mg/mL of desmopressin and is given at a dose of 300 µg/kg.¹ Usually, one dose is sufficient. If a second dose is needed, it is given 8 to 24 hours after the first dose. Desmopressin should be used with caution in older patients with cardiovascular disease because of the potential risk of drug-induced thrombosis.^{1,3,9,12,13}

Patients with type 1 von Willebrand disease are the best candidates for desmopressin therapy. Desmopressin treatment must not be started without previous testing to determine which variant form of von Willebrand disease is involved. It is not effective for type 3 and most variants of type 2 von Willebrand disease.¹ These patients are treated with factor VIII replacement that retains the HMW (high molecular weight) vWF multimers (Humate-P or Koate HS).¹ In patients with type 2 variants with qualitative defects in vWF, Humate-P or Koate HS supplies functional HMW vWF and factor VIII for those with decreased levels. In patients with type 3 von Willebrand disease, these replacement agents supply deficient materials, vWF, and factor VIII.¹ Affected women are often given oral contraceptive agents to suppress menses and avoid excessive physiologic loss of blood.^{3,9,12,13}

OTHER HEREDITARY PLATELET FUNCTION DISORDERS

The two most common hereditary platelet function disorders (HPFDs), Bernard-Soulier syndrome and Glanzmann thrombasthenia, are discussed in this chapter as examples

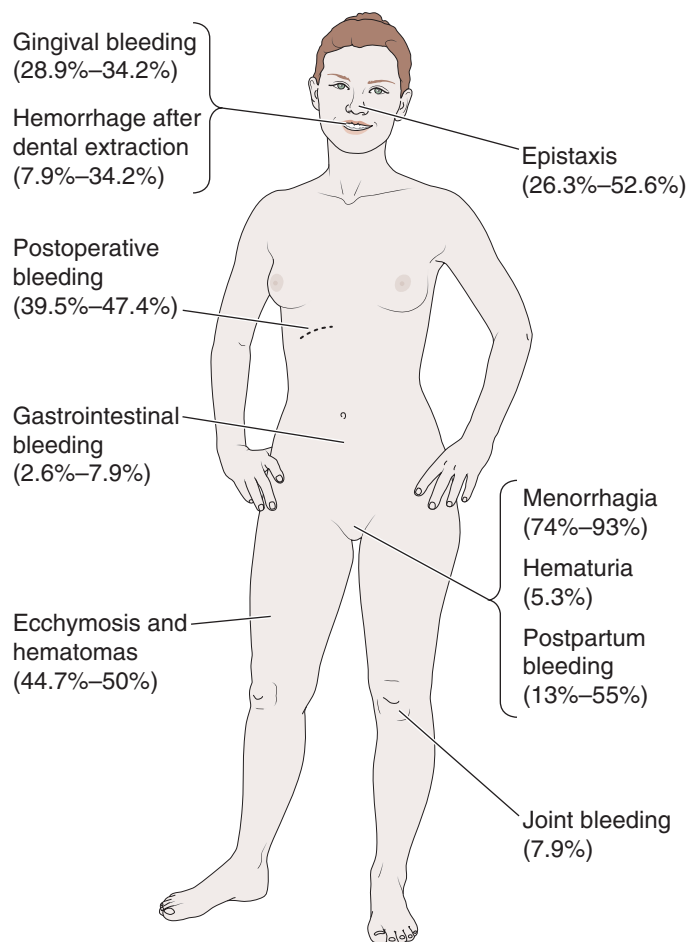

FIG 25.7 Clinical bleeding symptoms by type and frequency in patients with type 1 von Willebrand disease. (From Armstrong E, Konkle BA: von Willebrand disease. In Young NS, Gerson SL, High KA, editors: *Clinical hematology*, St. Louis, 2006, Mosby.)

of platelet function disorders.¹ Other HPFDs include an abnormal alpha granule formation as in the gray platelet syndrome (with marrow myelofibrosis), and of organelle biogenesis in the Hermansky-Pudlak and Chédiak-Higashi syndromes where platelet dense body defects are linked to abnormalities of other lysosome-like organelles including melanosomes. Finally, defects involving surface receptors (P2Y₁₂, TP α) needed for activating stimuli, of proteins essential for signaling pathways (including Wiskott-Aldrich syndrome), and of platelet-derived procoagulant activity (Scott syndrome) can result in HPFDs.^{23,24} The two most common HPFDs, Bernard-Soulier syndrome and Glanzmann thrombasthenia, are discussed in this chapter.

Hereditary thrombocytopenia (HT) is very rare. Several conditions are classified as HT. These include Fechtner syndrome, Alport syndrome, Sebastian platelet syndrome, and a syndrome consisting of HT, deafness, and renal disease.²⁵⁻²⁷ Owing to the rarity of these conditions, they are not covered in this book, and readers are referred to standard hematology textbooks for more information regarding these disorders.

Bernard-Soulier Syndrome

Bernard-Soulier syndrome represents one of the more common hereditary disorders of platelet adhesion. In this disease, the platelets are large and defective and unable to interact with vWF.¹ In some cases, the platelet count is decreased and hence the tendency of some authors to classify the syndrome as an HT disorder.²⁷ The disease is caused by mutations in genes controlling the expression of the platelet GP Ib/IX-V complex.¹ It is characterized by qualitative and quantitative defects of GP Ib of the platelet membrane. GP Ib appears to function as a receptor for vWF.¹

Clinical Presentation. Classic clinical findings in Bernard-Soulier syndrome include epistaxis, easy bruising, mucous membrane bleeding, perioperative bleeding and menorrhagia. Ecchymosis and gingival and GI bleeding may occur. Bleeding may be intermittent and unpredictable.^{1,28,29}

Laboratory and Diagnostic Findings. Laboratory testing for the platelet-type bleeding disorders hinges on an adequate assessment by history and physical examination. Patients with a lifelong history of platelet-type bleeding symptoms and perhaps a positive family history of bleeding are appropriate for testing. For patients thought to have an inherited disorder, testing for von Willebrand disease should be done initially because approximately 1% of the population has the disorder. The complete von Willebrand disease panel (factor VIII coagulant activity, vWf antigen, ristocetin cofactor activity) should be performed because many patients have abnormalities of only one particular panel component.¹ If the results of these studies are normal, platelet aggregation testing should be performed, ensuring that no antiplatelet medications have been ingested at least 1 week before testing.^{3,5,16}

Platelet morphology can easily be evaluated to screen for two uncommon qualitative platelet disorders: Bernard-Soulier syndrome (associated with giant platelets) and gray platelet syndrome, a subtype of storage pool disorder in which platelet granulation is morphologically abnormal by light microscopy.³⁰ The lack of well-standardized test systems continue to make the diagnosis of platelet defects cumbersome for practicing clinicians. Patient history and description of clinical bleeding symptoms are essential.^{1,29} Exclusion of von Willebrand disease, platelet count, and investigation of blood smears may provide a tentative diagnosis. Light transmission aggregometry is still considered the “gold standard” modality for assessing platelet function.^{1,29,31} In summary, laboratory tests show a low platelet count, large platelets, faulty platelet adhesion, and poor aggregation with ristocetin.^{1,5,29,31}

Medical Management. Treatment of patients with Bernard-Soulier syndrome generally is supportive, with platelet transfusions when absolutely necessary and avoidance of antiplatelet medications. Recombinant activated factor VII and desmopressin have been used to shorten bleeding times; however, their effectiveness varies from patient to patient.^{5,28,32,33}

Glanzmann Thrombasthenia

Glanzmann thrombasthenia is a rare autosomal recessive disease of platelet dysfunction. This disease is characterized by a deficiency or defect of the fibrinogen receptor (GP IIb/IIIa) on the platelet surface. The GP IIb/IIIa receptor has an essential function in the adhesion and aggregation of the platelets. The platelets of these patients cannot bind fibrinogen and aggregation does not occur.^{1,34,35} These platelets can adhere to the subendothelium by means of vWF but not to fibrinogen. Bleeding in this condition is very unpredictable.^{1,5,36,37}

Glanzmann thrombasthenia occurs in high frequency in certain ethnic populations with an increased incidence of consanguinity such as in Indians, Iranians, Iraqi Jews, Palestinian and Jordanian Arabs, and French Gypsies. Carrier detection is important to control the disorder in family members. Carrier detection can be done by both protein analysis and direct gene analysis.¹

Clinical Presentation. The recurrent features of GT are epistaxis, easy bruising, oral and gingival hemorrhage, GI bleeding, perioperative bleeding, hemarthrosis, and menorrhagia. Bleeding may be intermittent and unpredictable. Patients complain of bleeding from minor cuts and trauma.¹

Laboratory and Diagnostic Findings. Laboratory diagnostic testing for GT is the same as described for **Bernard-Soulier syndrome**.

Medical Management. Lifestyle advice and patient education programs, local measures, antifibrinolytic agents, hormone treatment, platelet transfusions, and recombinant activated factor VII are used to control bleeding.^{1,34} Activated factor VII at a dose of 80 to 120 µg/kg has been reported to be effective in controlling bleeding after tonsillectomy and severe epistaxis refractory to platelet transfusion.^{38,39}

COAGULATION DISORDERS

HEMOPHILIA A

The hemostatic abnormality in hemophilia A is caused by a deficiency or a defect of factor VIII. Factor VIII circulates in plasma bound to vWF. Unbound factor VIII is destroyed. Factor VIII was thought to be produced by endothelial cells and not by the liver, as most coagulation factors are. However, when disease was corrected by transplantation in several liver transplant recipients with hemophilia, it became clear that liver parenchymal cells also produce factor VIII.⁴⁰⁻⁴²

Hemophilia A is inherited as an X-linked recessive trait.^{2,43} The defective gene is located on the X chromosome (*F8* gene).¹¹ An affected man will not transmit the disease to his sons; however, all of his daughters will be carriers of the trait because they inherit his X chromosome. A female carrier will transmit the disorder to half of her

sons and the carrier state to half of her daughters. Severity of bleeding varies from kindred to kindred. Within a given kindred, the clinical severity of the disorder is constant; for example, relatives of people with severe hemophilia are likely to be affected severely. The mutation rate for the responsible gene is unusually high (up to 30%), which explains why a rare condition such as hemophilia A does not die out after several generations. Because of the high mutation rate of the responsible gene, a negative family history is of limited value in excluding the possibility of hemophilia A.^{4,11}

The assay of factor VIII activity can be used to identify female carriers of the trait. About 35% of carriers will show a decrease in factor VIII (≈50% of normal factor VIII levels). Other carriers may have normal levels of factor VIII. Immunoassays for vWF can greatly improve the detection rate among carriers of hemophilia A. Polymorphic DNA probes are now available that are capable of detecting 90% of affected families and 96% or more of carriers.^{2,4,11,43}

Hemophilia A can manifest in women. This occurs in a mating between an affected male and a female carrier. Half of the daughters of such a mating would inherit two abnormal X chromosomes—one from the affected father and one from the carrier mother. These daughters would have homozygous hemophilia. In addition, hemophilia may occur in a minority of heterozygous carriers. Rare cases of hemophilia in females have been attributed to a newly mutant gene.^{2,43}

Normal homeostasis requires at least 30% factor VIII activity. Symptomatic patients usually have factor VIII levels below 5%. Those with factor VIII levels between 5% and 30% have a mild form of the disease. Patients with levels between 1% and 5% have moderate disease, and severe forms of the disease occur when the level is less than 1% of normal. About 60% of cases of hemophilia are severe.⁴⁴

Clinical Presentation

Patients with severe hemophilia A bleed extensively from trivial injuries. However, the most characteristic bleeding manifestations associated with hemophilia A, such as hemarthrosis, often develop without significant trauma (Fig. 25.8). The frequency and severity of bleeding problems in patients with hemophilia are generally related to the blood level of factor VIII. Patients with severe hemophilia (<1% of factor VIII) may experience severe, spontaneous bleeding. Hemarthrosis, ecchymoses, and soft tissue hematomas are common (Figs. 25.9 and 25.10).

Gastrointestinal and genitourinary bleeding also is common in severe hemophilia. Spontaneous bleeding from the mouth, gingivae, lips, tongue, and nose may occur in these patients. Those with moderate hemophilia (1%–5% of factor VIII) exhibit moderate bleeding with minimal trauma or surgery. Hemarthrosis and soft tissue hematomas occur less often. Persons with mild hemophilia (5%–30% of factor VIII) may experience mild bleeding



FIG 25.8 Hemarthrosis of the right knee in a patient with hemophilia. (From Hoffbrand AV: *Color atlas of clinical hematology*, ed 3, St. Louis, 2000, Mosby.)

after major trauma or surgery. Hemarthrosis and soft tissue hematomas are seldom found in these patients.^{4,8,11}

Patients with hemophilia usually do not bleed abnormally from small cuts such as razor nicks. After larger injuries, however, bleeding out of proportion to the extent of injury is common. This bleeding may be massive and life threatening or it may persist as a slow, continuous oozing for days, weeks, or months. The onset of excessive bleeding usually is delayed. At the time of surgery or injury, hemostasis appears to be normal. Bleeding of sudden onset and serious proportions may develop several hours or even several days later. Venipuncture, if skillfully performed, is of no danger to the patients with hemophilia because of the elasticity of the venous walls.⁴⁵

Laboratory and Diagnostic Findings

Screening tests that show prolonged aPTT, normal PT, and normal platelet count (except in some cases of von Willebrand disease) indicate a problem in the intrinsic pathway. The next step is to mix (mixing tests) the patient's



FIG 25.9 A, The swelling in the submandibular region in a patient with hemophilia was caused by bleeding after intraoral trauma. **B**, The floor of the mouth has been elevated because of the bleeding. (From Hoffbrand AV: *Color atlas of clinical hematology*, ed 3, St. Louis, 2000, Mosby.)

blood with a sample of pooled plasma and repeat the aPTT. If this test result is normal, then the specific missing factor is identified by specific assays. If the mixing test result is abnormal, tests for inhibitor activity (antibodies to the factor) are performed.^{4,8,11}



FIG 25.10 Massive hematomas in a patient with hemophilia. In the absence of major trauma, hematomas of this size always indicate a severe coagulation abnormality. Possible causes include hemophilia, Christmas disease, von Willebrand disease, and uncontrolled anticoagulant therapy. Internal bleeding is a common accompaniment, and patients require urgent investigation and treatment. (From Forbes CD, Jackson WF: *Color atlas and text of clinical medicine*, ed 3, London, 2003, Mosby.)

Medical Management

Important nonpharmacologic aspects in the management of patients with hemophilia: avoidance of contact sports, patient education regarding the disease with the promotion of exercises such as swimming, avoidance of aspirin and other nonsteroidal antiinflammatory drugs (NSAIDs), orthopedic evaluation and physical therapy evaluation in patients with joint involvement, and hepatitis vaccination.²

The long-term survival of patients with hemophilia has been greatly affected by contamination of donated blood with human immunodeficiency virus (HIV) and hepatitis C virus (HCV). Despite the advent of virally safe blood products and blood treatment programs, nearly 70% of patients with hemophilia are HIV seropositive. Survival is of normal expectancy in HIV-negative persons with mild disease. Intracranial bleeds are the second most common cause of death in patients with hemophilia after AIDS. They are fatal in 30% of patients, occur in 10% of affected individuals, and are generally the result of trauma.² HIV has tripled the death rate in patients with hemophilia and currently is responsible for more than 55% of all deaths related to hemophilia.⁸ By contrast,

the lifetime risk of death from intracranial hemorrhage is 2% to 8%. More than 75% of adults with hemophilia A and 45% of adults with hemophilia B are HIV positive. The anti-HIV protease inhibitors result in prolonged HIV disease survival among this group of patients. With the exception of HIV and HCV infection, life expectancy is related to the severity of hemophilia, and the mortality rate is four to six times higher for severe disease than for mild to moderate disease. The mortality rate among patients with inhibitors is much greater than among those without inhibitors.^{2,8}

The aim of chronic treatment is to prevent spontaneous bleeding and excessive bleeding during any surgical intervention. Prophylaxis with recombinant factor VIII can prevent joint damage and the frequency of joint and other hemorrhages in young boys with severe hemophilia A is expensive because insurance may pay or negotiate a lower rate. Implantation of genetically altered fibroblasts that produce factor VIII is safe and well tolerated. This form of treatment is feasible in patients with severe hemophilia. Hemophilia will likely be the first common, severe genetic disease to be cured by gene therapy.²

Reversal and prevention of acute bleeding in hemophilia A and B are based on adequate replacement of deficient or missing factor protein. The choice of the product for replacement therapy is guided by availability, capacity, concerns, and cost. Recombinant factors cost two to three times as much as plasma-derived factors, and the limited capacity to produce recombinant factors often results in periods of shortage. In the United States, 60% of patients with severe hemophilia use recombinant products.²

Factor VIII concentrates are effective in controlling spontaneous and traumatic hemorrhage in severe hemophilia. Alloantibodies (inhibitors) that neutralize factor VIII clotting function occur in nearly 30% of patients with severe hemophilia A after exposure to factor VIII. Recombinant activated VII is useful to stop spontaneous hemorrhages and prevent excessive bleeding during surgery in 75% of patients with inhibitors.²

Replacement Factors. Factor VIII replacement guidelines for the control of bleeding from trauma or surgical procedures in patients with severe hemophilia are as follows. For minor spontaneous bleeding or minor traumatic bleeding, 25% to 30% replacement of factor VIII is required. For treatment or prevention of severe bleeding during procedures such as major dental surgery or maintenance replacement therapy after major surgery, 50% replacement or greater is needed. Treatment of life-threatening bleeding and limb-threatening bleeding during major surgery requires 80% to 100% replacement of factor VIII.^{2,4,8,11}

The choice of which type of factor concentrate should be used is based on specific findings from the patient's management history and infectious disease exposure (see [Table 25.3](#)). The efficacy of replacement preparations, whether recombinant or plasma derived, is the same.

Recombinant factor VIII concentrates are recommended for all patients with no history of factor concentrate treatment, for those who have received concentrates but are HCV and HIV seronegative, and after surgery or trauma for those with mild or moderate hemophilia that does not respond sufficiently to desmopressin therapy.² Plasma-derived concentrates are recommended for patients who are HCV and HIV seropositive. High-purity products are preferred in regimens for immune tolerance induction and prophylaxis.^{4,8,11}

Patients With Hemophilia Without Inhibitors. All types of general surgical procedures can now be performed in patients who do not have inducible inhibitors of factor VIII (inhibitors are antibodies to factor VIII that result from previous contact with factor VIII replacement). The expected rate of postoperative bleeding problems is 6% to 23%; with orthopedic surgery on the knee, this rate increases to 40%. Patients with mild deficiency of factor VIII can undergo surgical procedures if desmopressin (1-deamino-8-D-arginine [DDAVP], also called vasopressin) is used alone or in combination with ϵ -aminocaproic acid (aminocaproic acid). Desmopressin, which transiently increases the factor VIII level, can be given parenterally at a dose of 0.3 mg/kg or at an intranasal dose of 300 mg/kg. A second dose can be given if needed 8 to 24 hours after the first dose.⁴⁴

Aminocaproic acid is a potent antifibrinolytic agent that can inhibit plasminogen activators present in oral secretions and stabilize clot formation in tissue. Patients with more severe anti-hemophilic factor (AHF) deficiency require factor VIII replacement. Aminocaproic acid also is given to patients who are receiving factor replacement. Aspirin, aspirin-containing drugs, and other NSAIDs that impair platelet function and may cause severe bleeding must be avoided. Factor VIIa, a newer recombinant product, is now used in some patients with severe hemophilia A with inducible inhibitors.⁴⁴

Patients With Hemophilia With Inhibitors. A complication that poses great difficulties in the management of patients with hemophilia is the appearance of factor VIII inhibitors. These inhibitors are usually immunoglobulin G (IgG) antibodies to factor VIII. Factor VIII inhibitors (antibodies) develop in patients who have received multiple factor VIII replacement therapy. About 5% to 10% of patients with hemophilia have factor VIII inhibitors. The increasing use of factor VIII concentrates increases the risk for development of factor VIII inhibitors; 20% to 30% of severe hemophiliac patients are affected. About 40% of patients with hemophilia with inhibitors are *low responders*. Patients with hemophilia whose inhibitor levels rise with additional contact with factor VIII concentrates are called *high responders*; this situation is found in about 60% of patients with hemophilia with inhibitors. The medical management of patients with hemophilia is determined by the absence of inhibitors and low or high responder status. Patients who are most difficult to manage are high responders.^{2,8,46}

Low responders with minor bleeding can be treated with human factor VIII concentrates. The dosage for these patients is larger than for those without inhibitors. Activated prothrombin complex concentrates may be used if needed in this group of patients. Also, porcine factor VIII can be used if low levels of cross-reactivity with this agent occur. For surgical or invasive procedures in low responders, any of these treatments may be used.²

With the development of recombinant activated factor VIIa (NovoSeven), an effective treatment became available for the management of patients with hemophilia who are high responders.^{2,8,46}

HEMOPHILIA B

In hemophilia B (Christmas disease), factor IX is deficient or defective. Hemophilia B is inherited as an X-linked recessive trait (*F9* gene).¹¹ Factor IX levels below 10% have been reported in a few women. Similar to hemophilia A, the disorder manifests primarily in males. Severe disease, in which affected patients have less than 1% of normal amounts of factor IX, is less common than in hemophilia A. Clinical manifestations of the two disorders are identical. Screening laboratory test results are similar for both diseases. Specific factor assays for factor IX establish the diagnosis. Purified factor IX products (see Table 25.3) are recommended for the treatment of minor and major bleeding. Recombinant factor IX is now available for clinical use.^{2,8,46}

Gene Therapy. Hemophilia A and B are model diseases for gene therapy because they are caused by specific, well-defined gene mutations.^{8,47} Although a number of gene therapy studies have been initiated in the United States^{44,40,48} problems with vector safety, vector immune response, and inhibitor antibody formation have not yet been solved, and optimal levels of transgene expression have yet to be determined.^{4,8}

OTHER GENETIC CLOTTING FACTOR DEFICIENCIES

Congenital deficiency of prothrombin occurs rarely. Factor V deficiency also is rare; only about 1 case per 1 million people is reported.⁴ Factor VII, which is inherited as an autosomal recessive trait, affects males and females equally; the incidence is about 1 in 500,000.⁴ Factor X deficiency also is found in about 1 in 500,000 persons.⁴ Factor XI deficiency most often occurs in Ashkenazi Jews but also is seen in non-Jewish populations. Subjects with a deficiency of factor XII, prekallikrein, or high-molecular-weight kininogen do not have clinical bleeding problems but do have prolonged aPTT. Another very rare clotting deficiency with significant bleeding problems involves factor XIII; this has been described in just over 100 clinical cases. PT and aPTT test results are normal in these patients.⁴⁹

Another small group of patients with a history of significant bleeding problems will have negative test results

when screened by means of currently recommended methods. It appears that current methods are unable to reveal whatever disorder these patients may have. A clear-cut history of prolonged bleeding after trauma or surgical procedures is always more significant than negative laboratory data.^{6,8,11,15}

Three known defects in the coagulation system do not affect PT, aPTT, or TT. These are very rare and include factor XIII deficiency, α_2 plasmin inhibitor deficiency, and plasminogen activator inhibitor-1 deficiency (major inhibitor of plasminogen activators). Patients with a strong clinical history of bleeding and normal coagulation test results (PT, aPTT, and TT) require additional testing, such as the use of 5M urea.⁴⁴

Risk of Infection With Replacement Products

The use of cryoprecipitates, some factor VIII concentrates, and fresh-frozen plasma carries several important risks. For example, transmission of hepatitis B virus (HBV), HCV, and HIV may occur.⁴⁵

In the 1980s, more than 90% of multiply transfused patients with hemophilia became HIV positive, with the subsequent development of acquired immunodeficiency syndrome (AIDS). Many of these patients have died from the disease. The advent of sterile concentrates together with rigid donor testing begun in 1985, and the availability of recombinant products, has greatly reduced the risk of HIV infection through blood product administration. AIDS cases associated with hemophilia B has been less common, probably because of the rarity of this condition. A look at hemophilia mortality rate from 1900 to 1990 reveals the terrible impact of HIV infection. Survival increased from 1970, when factor VIII replacement first became available, to 1980, with a median life expectancy of 68 years. However, from 1980 to 1990, this decreased to 49 years. Most of this effect was caused by infection with HIV from contaminated blood products.⁴⁵

During the 1970s and 1980s, more than 90% of patients treated with plasma-derived clotting factor concentrates became infected with HCV. This exposure rate has been greatly reduced on the basis of donor screening for HCV antibodies since the later 1980s, viral inactivation procedures started in 1985, and the use of ultrapure concentrates. As a result of the earlier contaminated blood pool, however, more than 80% of adult patients with hemophilia are infected with HCV. More than 25% of adult patients with hemophilia have biopsy-demonstrated cirrhosis, and HCV infection is the second leading cause of death in this population. Coinfection with HIV increases the risk for liver failure.^{4,40,42}

Transmission of other infectious agents in blood products has occurred in the past. These agents have included various hepatitis viruses (HAV, HBV, HDV, and HGV) and parvovirus B19. Because of screening procedures and viral inactivation procedures, the hepatitis viruses (A, B, D, and G) have not been a major concern since

1985. Many patients with hemophilia who received multiple concentrate replacements before 1985 were infected with HBV. However, the rate of chronic infection was about 5% to 10%, and liver failure occurred late in some of these patients. Evidence of parvovirus B19 infection is found in 1 of every 1000 blood donors. About 80% of adult patients with hemophilia show evidence of infection with parvovirus B19, which occurs even in those who are given viral attenuated products.^{4,40,42} The long-term consequences of parvovirus B19 infection in hemophilia are not established.

Screening of blood donors, viral inactivation procedures, preparation of ultrapure concentrates, and the advent of porcine factor VIII have eliminated or greatly reduced the risk of infection in patients with hemophilia with HIV, HCV, HBV, HGV, and other agents.^{4,40,42}

Congenital Hypercoagulability

Many patients with venous thromboembolism have an inherited basis for hypercoagulability. The initial episode of venous thromboembolism usually occurs in early adulthood, but onset may be at any time from early childhood to old age. Arterial thrombosis is unusual in patients with inherited hypercoagulable states. Primary hypercoagulable states result from a deficiency of anti-thrombotic factors (antithrombin III, protein C or protein S) or increased prothrombotic factors (factor Va [activated protein C resistance, factor V Leiden]: prothrombin [prothrombin G20210A mutation]; factors VII, XI, IX, VIII; von Willebrand factor; fibrinogen; and hyperhomocysteinemia) (Fig. 25.11).^{50,51}

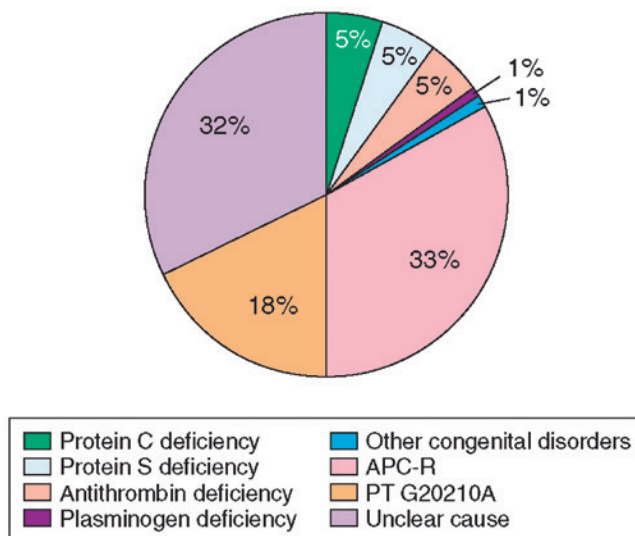

FIG 25.11 Results of testing for congenital hypercoagulable states projected for patients who had experienced idiopathic deep venous thrombosis in 2003. *APC-R*, Activated protein C resistance; *PT G20210A*, prothrombin G20210A mutation. (From Deitcher SR: Hypercoagulable states. In Carey WD, et al, editors: *Cleveland Clinic's current clinical medicine*, ed 2, Philadelphia, 2010, Saunders.)

Inherited quantitative or qualitative deficiency of *antithrombin III* leads to increased fibrin accumulation and a lifelong propensity to thrombosis. Antithrombin is the major physiologic inhibitor of thrombin and other activated coagulation factors; therefore, its deficiency leads to unregulated protease activity and fibrin formation. The frequency of asymptomatic heterozygous antithrombin deficiency in the general population may be 1 in 350. Most of the affected persons have clinically silent mutations and never have thrombotic manifestations. The frequency of symptomatic antithrombin deficiency in the general population has been estimated to be between 1 in 2000 and 1 in 5000. Among all patients seen with venous thromboembolism, antithrombin deficiency is detected in only about 1%.⁵⁰

Protein C deficiency leads to unregulated fibrin generation because of impaired inactivation of factors VIIIa and Va, two essential cofactors in the coagulation cascade. The prevalence of heterozygous protein C deficiency in the general population is about 1 per 200 to 500. Protein C deficiency is found in 3% to 4% of all patients with venous thromboembolism.⁵⁰

Protein S is the principal cofactor of activated protein C (APC), and its deficiency mimics that of protein C in causing loss of regulation of fibrin generation by impaired inactivation of factors VIIIa and Va. The prevalence of protein S deficiency in the general population is unknown. Its frequency in all patients evaluated for venous thromboembolism (2% to 3%) is comparable, however, to that of protein C deficiency.⁵⁰

The *factor V Leiden* mutation (activated protein C resistance) is remarkably frequent (3%–7%) in healthy white populations but is far less prevalent in certain black and Asian populations.⁵² In various studies, activated protein C resistance was found in a wide range of frequencies (10%–64%) among patients with venous thromboembolism.^{50,52}

The substitution of G for A at nucleotide 20210 of the prothrombin gene has been associated with elevated plasma levels of prothrombin and an increased risk for venous thrombosis. The allele frequency for this gain-of-function mutation is 1% to 6% in white populations, but it is much less prevalent in other racial groups. The *prothrombin G20210A mutation* is found in 6% to 8% of all patients with venous thromboembolism.^{50,51}

The laboratory diagnosis of the primary hypercoagulable states requires testing for each of the disorders individually because no general screening test is available to determine whether a patient may have such a condition. At this time, functional, immunologic, or DNA-based assays are available to test for antithrombin deficiency, protein C deficiency, protein S deficiency, APC resistance (factor V Leiden), and the prothrombin G20210A mutation.^{50,51}

More detailed information on the diagnosis and medical management of patients with primary hypercoagulable states is available in standard medicine and hematology

textbooks. In general, any needed dental treatment can be provided for these patients.

Dental Management

Patient Identification. The four methods by which the dentist can identify the patient who may have a bleeding problem are a good history, careful physical examination, screening laboratory tests, and occurrence of excessive bleeding after a surgical or invasive dental procedure.

History and Symptoms. Patients with severe coagulation disorders may have dramatic abnormal bleeding histories but often do not volunteer this information unless asked. A history of spontaneous hemarthroses and muscle hemorrhages is highly suggestive of severe hemophilia. By contrast, epistaxis, gingival bleeding, and menorrhagia are reportedly found in patients with thrombocytopenia, platelet disorders, or von Willebrand disease.⁶ Several hemorrhagic symptoms are more specific for certain disorders—for example, a history of prolonged bleeding after extraction of teeth is more suggestive of von Willebrand disease or platelet disorders than of hemophilia. Patients with a history of bruising and bleeding but with normal results on coagulation tests and normal platelet counts may be afflicted with blood vessel diseases such as HHT, Cushing disease, scurvy, Ehlers-Danlos syndrome, or other similar conditions.¹⁷

The history should include questions on six topics: bleeding problems in relatives; excessive bleeding after operations, surgical procedures, and tooth extractions; excessive bleeding after trauma; use of drugs for prevention of coagulation or chronic pain; past and present illness; and occurrence of spontaneous bleeding (e.g., nosebleeds).

Bleeding Problems in Relatives

Male offspring of parents with a family history of hemophilia are at risk for the disease. Hemophilia is very rare in females but can occur when a man with hemophilia marries a female carrier and they have female children, half of whom will have hemophilia. Children of a parent with von Willebrand disease type 1 also are at risk; about 33% of them will inherit the disorder. Children of parents with a hereditary disorder of connective tissue or hereditary hemorrhagic telangiectasia are at risk for a bleeding disorder. In rare cases of a family history of disorders of platelet function, such as Bernard-Soulier syndrome or Glanzmann thrombasthenia, the bleeding disorder may be passed to offspring.

The most meaningful data are reported as a recent negative or positive history of excessive bleeding after a major hemostatic challenge. With a negative history, the patient is not a bleeder. By contrast, the patient with a positive history is a bleeder. A negative history of bleeding after minor insults in a patient with a mild bleeding diathesis does not rule out a problem with more severe surgical or traumatic events. Thus, the more recent and severe the surgical or traumatic event, the more accurate it will be in revealing the presence of a bleeding disorder.

Physical Examination

The dentist should inspect the exposed skin and mucosa of the oral cavity and pharynx of the patient for signs that might indicate a possible bleeding disorder. Signs include petechiae, ecchymoses (bruises), spider angioma, telangiectasias, jaundice, pallor, and cyanosis (possible thrombocytopenia). When any of these signs are found by the dentist and cannot be explained by the history or other clinical findings, the patient should be referred for medical evaluation.

Screening Laboratory Tests

The dentist can use four clinical laboratory tests to screen patients for congenital bleeding disorders: platelet count, aPTT, PT, and TT. The platelet count is ordered to screen for thrombocytopenia. The aPTT test is used to measure the status of the intrinsic and common pathways of coagulation. This test reflects the ability of blood remaining within vessels in the area of injury to coagulate. It will be prolonged in coagulation disorders affecting the intrinsic and common pathways (hemophilia, liver disease) and in cases of excessive fibrinolysis.

If positive, the results of these screening tests direct the hematologist to the possible source of a bleeding disorder and allow for the selection of more specific tests to identify the nature of the defect.

Medical Considerations

Surgical procedures should be not performed on a patient who is suspected of having a bleeding problem on the basis of history and physical examination findings. Such a patient should be screened by the dentist through appropriate clinical laboratory tests or should be referred to a hematologist for screening. Patients screened by the dentist with abnormal test results should be referred to a hematologist for diagnosis, treatment, and management recommendations. Patients under medical care who may have a bleeding problem should not receive dental treatment until consultation with the patient's physician has taken place and after appropriate preparations have been made to avoid excessive bleeding after dental procedures.

Management of the Patient With a Serious Bleeding Disorder

Dental treatment of patients with hemophilia A and with von Willebrand disease is used here to show how patients with a serious congenital bleeding disorder can be managed to avoid significant bleeding complications.⁵³

Before any dental treatment is performed for a patient with a bleeding disorder, the dentist must consult with the patient's physician to determine the severity of the disorder and the need for special preparations for dental treatment. Patients with significant bleeding disorders are at increased risk for spontaneous gingival bleeding or excessive bleeding after minor trauma to the oral tissues.

The risk of such problems will be even greater if surgical procedures are performed without special preparations.

Hemophilia. Hemophilia A (factor VIII deficiency) can be used to illustrate some of the management problems involved in dealing with a serious coagulation disorder. When a patient with this medical diagnosis (or with a clinical history suggestive of the disorder) presents for dental treatment, consultation with a hematologist is essential. The hematologist first establishes the diagnosis and determines the degree of factor VIII deficiency, whether any factor VIII inhibitors are present, if the patient is a low or a high responder, and whether hospitalization will be needed. The type of replacement material is selected (Box 25.2; see also Table 25.3), and the hematologist determines the dosage of replacement material that should be used.^{4,15}

Patients with severe hemophilia A exhibit signs and symptoms at a very early age. It is important that preventive dentistry practices be initiated early and maintained through adulthood for all patients with hemophilia. Dental caries and periodontal disease should be minimized in these patients. The use of fluorides and fissure sealants and dietary recommendations regarding refined carbohydrate restriction are important for minimizing tooth loss. Toothbrushing, flossing, and regular dental visits, including cleaning of the teeth, are important for prevention of caries and periodontal disease, which should be treated when detected. Through maintenance of good oral hygiene and dental repair, the need for dental procedures requiring factor VIII replacement can be minimized.

In general, block anesthesia, lingual infiltrations, or injections into the floor of the mouth and intramuscular injections must be avoided unless appropriate replacement factors have been used in patients with moderate to severe factor VIII deficiency. Complex restorative procedures usually require replacement therapy.

Infiltration anesthesia and intraligamentary injections usually can be given without replacement therapy. Simple restorative procedures often can be performed without replacement therapy, as can endodontic treatment of nonvital teeth. However, overinstrumentation and overfilling must be avoided. Some experts recommend topical application of 10% cocaine to exposed pulp when a pulpectomy is performed. Intra canal injection of a local anesthetic along with epinephrine will help to control bleeding. Topical application of 1:1000 epinephrine with paper points also will help to control bleeding until the pulp has been removed.⁵⁴

Orthodontic treatment can be provided to patients with hemophilia, but sharp edges on appliances must be avoided. Sharp edges can injure the mucosa, causing significant bleeding in patients with severe to moderate hemophilia.

Periodontal surgery, root planing, extractions, dentoalveolar surgery, soft tissue surgery, and complex oral surgery usually require factor replacement in patients with

BOX 25.2 Dental Management of Patients With Hemophilia**P****Patient Evaluation and Risk Assessment (see Box 1.1)**

- Evaluate and determine whether a bleeding disorder (e.g., hemophilia) exists.
- Obtain medical consultation if undiagnosed, poorly controlled, or if uncertain. Screen patients with bleeding history or clinical signs of a bleeding disorder with PT, PTT, TT, and platelet count.

Potential Issues and Factors of Concern**A**

Analgesics	Avoid aspirin, aspirin-containing compounds, and other NSAIDs; acetaminophen with or without codeine is suggested for most patients.
Antibiotics	Not indicated unless acute infection is present.
Anesthesia	Avoid block anesthetic injections in patients not on desmopressin, aminocaproic acid, or factor concentrates.
Anxiety	No issues
Allergy	Patients placed on factor VIII replacement need to be observed for signs and symptoms of allergy.

B

Bleeding	These patients are at great risk of bleeding from invasive dental procedures. Special precautions must be taken before invasive procedures. Patients with mild to moderate hemophilia can be managed using desmopressin and aminocaproic acid for many dental procedures. Factor VIII replacement is needed for patients with more severe hemophilia. Patients who are low responders for inhibitors (antibody response to factor VIII) require higher doses of factor VIII. Patients who are high responders are most difficult to manage and require activated factor VII, porcine factor VIII, steroids, or other special preparations such as prothrombin complex concentrates or activated prothrombin complex concentrations.
Breathing	No issues
Blood pressure	No issues

C

Chair position	No issues
Cardiovascular	No issues
Consultation	The patient's hematologist must be consulted before any invasive dental procedures are performed. The severity of disease must be established. The presence of inhibitors and level of response to factor VIII need to be determined. Determine if the patient can be managed with desmopressin and aminocaproic acid. Establish the type and dosage of factor replacement needed for invasive dental procedures or surgery. Determine if the patient can be managed in the dental office or will require hospitalization.

D

Devices	Splints may be constructed before multiple extractions or surgical procedures in patients with severe hemophilia.
Drugs	Avoid all drugs that may cause bleeding, such as aspirin and other NSAIDs, certain herbal medications, and over-the-counter drugs containing aspirin.

E

Equipment	No issues
Emergencies	Excessive bleeding may occur after invasive dental procedures or surgery. Systemic and local means may be required to control the bleeding (see Tables 25.3 and 25.6). Allergic reactions may occur in patients receiving factor replacement.

F

Follow-up	Patients should be seen and examined for signs of allergy or bleeding within 24 to 48 hours after surgical procedures
-----------	---

NSAID, Nonsteroidal antiinflammatory drug; PT, prothrombin time; PTT, partial thromboplastin time; TT, thrombin time.

moderate to severe factor VIII deficiency. When mucoperiosteal flaps are required in the mandibular region, the buccal or labial approach is suggested. Also, the buccal approach is recommended for surgical removal of mandibular third molars. Trauma to mandibular lingual tissues increases the risk of bleeding, which can lead to airway obstruction. Mandibular acrylic splints are not used as often as they were in the past because of problems with tissue trauma and infection.⁵⁴ If local bleeding occurs, one or more of the procedures listed in Table 25.6 can be used to control it.

Conservative periodontal procedures, including polishing with a prophylaxis cup and supragingival calculus removal, often can be performed without replacement therapy as long as injury to the gingival tissues is avoided. In children, primary teeth should be removed soon after they become loose. Patients with mild factor VIII deficiency and no inhibitors often can be managed in the dental office for less invasive procedures such as scaling, soft tissue surgery, and extractions without factor VIII replacement; desmopressin and aminocaproic acid or tranexamic acid may be used. Patients with

TABLE 25.6 Topical Hemostatic Agents Used to Control Bleeding

Product	Company or Manufacturer	Description	Indications and Features
Gauze		2 × 2 inch sterile gauze pads; placed over the wound, with pressure applied by patient (by closing jaws or with fingers)	Bleeding immediately after extractions or minor surgical procedures
Gelfoam	Pharmacia & Upjohn	Absorbable gelatin sponge made from purified gelatin solution; absorbs in 3–5 days	Useful for most patients taking an antithrombotic agent; helpful to place topical thrombin on Gelfoam; for extensive or invasive surgery, can be placed inside a splint
HemCon Dental Dressing	HemCon Medical Technologies	10- × 12-mm or 1- × 3-inch dressing; place on wound (best if some blood is present, helps stick dressing to the wound); made of chitosan from shellfish	Can be used on extraction sites and oral wounds; can be used in patients taking anticoagulants
CELLULOSE			
Surgicel Oxycel	Johnson & Johnson Becton Dickinson	Oxidized regenerated cellulose; exerts physical effect rather than physiologic; swells on contact with blood with resulting pressure adding to hemostasis; thrombin is ineffective with these agents because of inactivation as a result of pH factors	After 24–48 hr, it becomes gelatinous; can be left in place or removed; useful to control bleeding when other agents ineffective
COLLAGEN			
Instat	Johnson & Johnson	Absorbable collagen made from purified and lyophilized bovine dermal collagen; can be cut or shaped; adheres to bleeding surfaces when wet but does not stick to instruments, gloves, or gauze sponges	Mild to moderate bleeding usually controlled in 2–5 min; more expensive than Gelfoam
Avitene Helistat	MedChem Products Marion Merrell Dow	Microfibrillar collagen hemostat: dry, sterile, fibrous, water insoluble HCl acid salt–purified bovine corium collagen: MCH attracts platelets and triggers aggregation in fibrous mass	Thrombin ineffective with these agents because of inactivation as a result of pH factors; moderate to severe bleeding
Colla-Cote, Tape, Plug	Zimmer Dental	Absorbable collagen dressings from bovine sources; can be sutured into place, used under stents or dentures or alone; fully resorbed in 10–14 days	Shaped according to intended use: “cote” $\frac{3}{4}$ × 1.5 inch, tape 1 × 3 inch, plug $\frac{3}{8}$ × $\frac{3}{4}$ inch; all are superior hemostats for moderate to severe bleeding
THROMBIN			
Thrombostat Thrombinar Thrombogen	Parke-Davis Jones Medical Johnson & Johnson—Merck	Topical thrombin—directly converts fibrinogen to fibrin; derived from bovine sources	One 5000-unit vial dissolved in 5 mL of saline can clot equal amount of blood in <1 sec; useful in severe bleeding.
Tranexamic acid Lysteda (Tablets)	Xanodyne	Tranexamic acid works as a competitive inhibitor of plasminogen activation; used as a mouth wash (5%), taken orally as a tablet, or given IV	Useful in the short term for preventing hemorrhage after dental extractions
Cyklokapron (IV) Amicar Tablets (500 mg) Syrup (1.25 g/5 mL) IV (250 mg/ mL)	Pfizer Wyeth-Ayerst	ϵ -Aminocaproic acid works as a competitive inhibitor of plasminogen activation; most often used as a mouth wash; can be taken orally or by IV	Useful in the short term to prevent bleeding
Histocryl	B. Braun	Active ingredient is <i>N</i> -butyl 2-cyanoacrylate, serves as a glue to protect surgical wounds	Useful in the short term to prevent bleeding
Beriplast	Behring Werke	Fibrin/tissue glue	Not available in the United States at this time

IV, Intravenous; MCH, Mean Corpuscular Hemoglobin (hemoglobin content of red blood cells).

moderate factor VIII deficiency without inhibitors may require factor VIII replacement for less invasive dental procedures. Patients with moderate hemophilia and no inhibitors will require factor VIII replacement for major oral surgery. Patients with severe hemophilia will require factor VIII replacement for all invasive dental treatments.⁴⁴ One or more of the local procedures listed in [Table 25.6](#) can be used as adjuncts to aid in the control of bleeding.

Tranexamic acid can be administered orally, intravenously, or as a mouth wash. In 2009, the U.S. Food and Drug Administration approved oral tranexamic acid tablets (Lysteda, Ferring Pharmaceuticals, Saint-Prex, Switzerland) for use in patients with heavy menstrual bleeding. An intravenous form of tranexamic acid, Cyklokapron (IV) (Pfizer, New York), has been approved for use in the United States. Tranexamic acid preparations originally were approved for use in hemophilia to reduce or prevent hemorrhage during or after tooth extraction and to control heavy menstrual bleeding. However, tranexamic acid is now used to control bleeding in a number of situations. Care must be taken with use of this drug because of the risk for thrombotic events, particularly in older patients and with long-term use.⁴⁴

Cyklokapron (IV), 10 mg/kg, is given just before the surgical procedure and then three times per day as needed. It is supplied in 100-mg vials. Lysteda comes in 500 mg tablets, 25 mg/kg, and is given just before the surgery and then three to four times per day as needed. The dentist can request the pharmacy to prepare a 5% solution of tranexamic acid to be used as a mouth wash. The patient is instructed to take 5 mL of the solution and hold in the mouth for 2 minutes and then spit it out. The first dose should be taken just before the procedure and repeated four times per day as needed.⁴⁴

Patients with hemophilia with inhibitors who are low responders usually will require factor VIII replacement for any invasive dental procedure. Human, porcine, or ultrapure factor VIII replacements may be used, depending on the clinical situation. Patients with hemophilia who are high responders require factor VIIa concentrate for all invasive dental procedures.

Patients with hemophilia who have undergone invasive dental procedures should be seen within 24 to 48 hours by the dentist to check on control of bleeding. If bleeding is occurring, the hematologist may have to give additional factor VIII replacement concentrates, or the dentist may need to apply one or more of the local procedures listed in [Table 25.6](#). Patients who have received factor VIII replacements also must be examined within 24 to 48 hours after surgery for any evidence of an allergic reaction to the concentrates and to determine whether the wound is healing without complications.

Before surgery, the dentist can make splints so that mechanical displacement of the clot in wounds healing by secondary intention is prevented. Care should be taken in the construction of the splints so that pressure is not

placed on soft tissues; such pressure could lead to tissue injury, bleeding, and infection. For these reasons, mandibular acrylic splints may no longer be used. All extraction sites should be packed with microfibrillar collagen, and the wound should be closed with sutures for primary healing whenever possible. Endodontic procedures should be performed, rather than extractions, whenever possible because the risk for serious bleeding is lessened by this approach.

In many instances, the patient must be hospitalized for dental surgical procedures. This decision should be made according to the procedure planned and in consultation with the patient's hematologist. Patients who have a mild to moderate form of hemophilia without inhibitors can be managed on an outpatient basis with the use of desmopressin, aminocaproic acid, or tranexamic acid, or with replacement therapy plus aminocaproic acid. When replacement therapy is used, the dentist and the hematologist must observe the patient for any signs of allergic reaction and must be prepared to take appropriate action. [Box 25.2](#) reviews the roles and functions of the hematologist and the dentist in managing patients with hemophilia. Postoperative pain control usually can be obtained with the use of acetaminophen with or without codeine (see [Box 25.2](#)).

Von Willebrand Disease. Surgical procedures can be performed in patients with mild von Willebrand disease (type 1 and some type 2 variants) with the use of desmopressin and episolon aminocaproic acid (EACA) or tranexamic acid. Patients with more severe types of von Willebrand disease require factor VIII concentrates such as Humate-P that retain vWF multimers to replace the missing vWF and factor VIII. A study by Federici and colleagues⁴⁴ reported the results of bleeding complications in 63 consecutive patients with von Willebrand disease. Of these cases, 31 had type 1, 22 had type 2 variants, and 10 had type 3 von Willebrand disease. All patients had undergone extractions or periodontal surgery. In all cases, tranexamic acid was given before and for 7 days after surgery. Fibrin glue (not available in the United States) was used as local therapy in several patients during surgery. Desmopressin or factor VIII concentrates with vWF were given systemically as indicated. Of these patients, 29 were treated with tranexamic acid and local measures and did not experience excessive bleeding. Desmopressin was given to 24 patients, and 6 received factor VIII with vWF. Excessive bleeding after surgery occurred in only 2 patients. The investigators⁴⁴ concluded that tranexamic acid, fibrin glue, and desmopressin can prevent bleeding complications in the vast majority of patients with von Willebrand disease (84%). Surgery can be safely performed by providing adequate and timely hemostasis during and after the procedure in patients with von Willebrand disease.⁵⁵ [Box 25.3](#) reviews the roles and functions of the hematologist and dentist in the management of patients with von Willebrand disease.

BOX 25.3 Dental Management Considerations in Patients With von Willebrand Disease**P****Patient Evaluation and Risk Assessment (see Box 1.1)**

- Evaluate and determine whether bleeding disorder (e.g., von Willebrand) exists.
- Obtain medical consultation if signs and symptoms are suggestive of the disease, if the disease is poorly controlled, or if the diagnosis is uncertain. Screen patients with bleeding history or clinical signs of a bleeding disorder with PT, PTT, TT, and platelet count.

Potential Issues and Factors of Concern**A**

Analgesics	Avoid aspirin, aspirin-containing compounds, and other NSAIDs; acetaminophen with or without codeine is suggested for most patients.
Antibiotics	Not indicated unless acute infection is present.
Anesthesia	Avoid infiltration and block anesthetic injections in patients not on desmopressin, aminocaproic acid, or factor concentrates.
Anxiety	No issues
Allergy	Patients placed on factor VIII with vWF replacement need to be observed for signs and symptoms of allergy.

B

Bleeding	These patients may be at risk for bleeding from invasive dental procedures. Patients with type 2N and type 3 vWD are at greatest risk. Special precautions must be taken before invasive dental procedures and surgery. Most patients can be managed with desmopressin and aminocaproic acid. A few patients will require factor VIII with vWF.
Breathing	No issues
Blood pressure	No issue

C

Chair position	No issues
Cardiovascular	No issues
Consultation	The patient's hematologist must be consulted before any invasive dental procedures being performed. The diagnosis needs to be confirmed, the type of variant established, and the need for desmopressin factor VIII with vWF and aminocaproic acid determined. Patients with type 1 vWD, which is by far the most common, usually can be managed in the dental office using desmopressin; consultation will identify the few patients who may require factor VIII with vWF. Patients with type 2 disease (20%–30%) usually can be managed with desmopressin; in some cases, factor VIII with vWF also is needed. The patient's physician needs to test for desmopressin response. Type 3 vWD is rare and requires factor VIII with vWF in all cases. Patients with type 3 vWD and some with type 2 vWD may require hospitalization for surgical procedures.

D

Devices	Splints may be constructed before multiple extractions or surgical procedures in patients with type 3 vWD. Splints should not place excessive pressure on tissue and should be removed after bleeding is controlled so that tissue heals properly. Use local hemostatic agents as needed (see Table 25.6).
Drugs	Avoid all drugs that may cause bleeding such as aspirin and other NSAIDs, herbal medications, and over-the-counter drugs containing aspirin.

E

Equipment	No issues
Emergencies	Excessive bleeding may occur after invasive dental procedures or surgery. Systemic and local means may be required to control the bleeding (see Tables 25.3 and 25.6). Allergic reactions may occur in patients receiving factor replacement.

F

Follow-up	Patients should be seen and examined for signs of bleeding within 24 to 48 hours after surgical procedures.
-----------	---

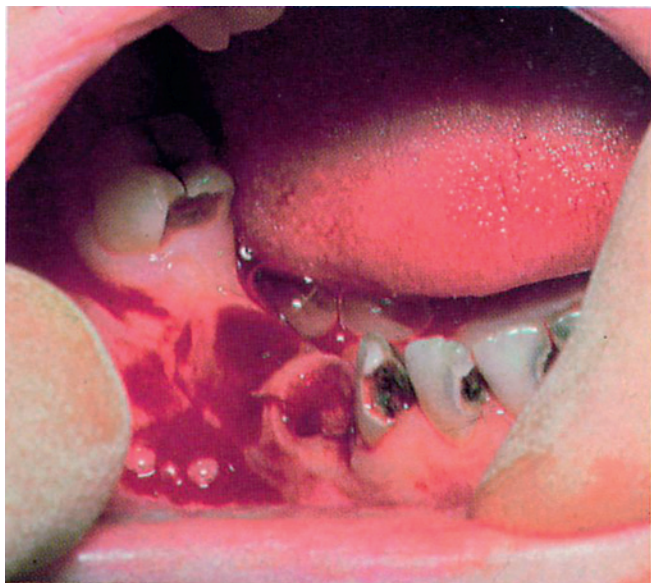

FIG 25.12 Severe hemorrhage after dental extraction often is the first clue to more minor degrees of coagulation disorder and is a common presentation in patients with hemophilia, Christmas disease, and von Willebrand disease. (From Forbes CD, Jackson WF: *Color atlas and text of clinical medicine*, ed 3, London, 2003, Mosby.)

Treatment Planning Modifications

With proper preparation, most indicated dental treatment can be provided for patients with various bleeding problems. Patients with congenital coagulation defects must be encouraged to improve and maintain good oral health because most dental treatment for these patients at present is complicated by the need for replacement of the missing factor. Dental treatment often requires hospitalization for patients with severe defects. Aspirin and other NSAIDs should not be used for pain relief in patients who have known bleeding disorders or who are receiving anticoagulant medication. Such medication includes the various compounds that contain aspirin, such as Anacin, Synalgos-DC, Fiorinal, Bufferin, Alka-Seltzer, Empirin with Codeine, and Excedrin. Also, herbal medications that may be associated with excessive bleeding are to be avoided (see [Appendix E](#)).

Oral Manifestations

Patients with congenital bleeding disorders may experience spontaneous gingival bleeding. Oral tissues (e.g., soft palate, tongue, buccal mucosa) may show ecchymoses and petechiae. Bleeding occurring after the extraction of teeth may be the first evidence of mild coagulation disorders such as hemophilia A, hemophilia B, or von Willebrand disease variants with factor VIII deficiency ([Fig. 25.12](#)). Spontaneous gingival bleeding and petechiae usually are found in patients with genetic platelet disorders or HHT. Hemarthrosis of the temporomandibular joint is a rare finding in patients with genetic coagulation disorders.

REFERENCES

- Nichols WL. von Willebrand disease and hemorrhagic abnormalities of platelet and vascular function. In: Goldman L, Schafer AI, eds. *Goldman-Cecil Medicine*. 25th ed. Philadelphia, PA: Elsevier (Saunders); 2016:1163-1183.
- Ferri FF. Hemophilia. In: Ferri FF, ed. *Ferri's Clinical Advisor 2015: 5 Books in One*. Philadelphia PA: Elsevier (Saunders); 2015.
- Baz R, Mekhail T. Disorders of platelet function and number. In: Carey WD, et al, eds. *Current Clinical Medicine 2009 - Cleveland Clinic*. Philadelphia: Elsevier Saunders; 2009:669-674.
- Ragni MV, Kessler CM, Lozier JN. Clinical aspects and therapy of hemophilia. In: Hoffman R, Furie B, McGlave P, eds. *Hematology: Basic Principles and Practice*. 5th ed. Philadelphia: Churchill Livingstone, Elsevier; 2009:1911-1930.
- Bennett JS. Hereditary disorders of platelet function. In: Hoffman R, Furie B, McGlave P, eds. *Hematology: Basic Principles and Practice*. 5th ed. Philadelphia: Churchill Livingstone, Elsevier; 2009:2133-2144.
- Coller BS, Schneiderman PI. Clinical evaluation of hemorrhagic disorders: the bleeding history and differential diagnosis of purpura. In: Hoffman R, Furie B, McGlave P, eds. *Hematology: Basic Principles and Practice*. 5th ed. Philadelphia: Churchill Livingstone, Elsevier; 2009:1851-1876.
- Deitcher SR. Hypercoagulable states. In: Carey WD, ed. *Current Clinical Medicine 2009 - Cleveland Clinic*. Philadelphia: Elsevier Saunders; 2009:639-646.
- Kessler CM. Hemorrhagic disorders: coagulation factor deficiencies. In: Goldman L, Ausiello D, eds. *Cecil Medicine*. 23rd ed. Philadelphia: Elsevier Saunders; 2008:1301-1313.
- White GCI, Sadler JE. von Willebrand disease: clinical aspects and therapy. In: Hoffman R, Furie B, McGlave P, eds. *Hematology: Basic Principles and Practice*. 5th ed. Philadelphia: Churchill Livingstone, Elsevier; 2009:1961-1972.
- Karsan A, Harlan JM. The blood vessel wall. In: Hoffman R, Furie B, McGlave P, eds. *Hematology: Basic Principles and Practice*. 5th ed. Philadelphia: Churchill Livingstone, Elsevier; 2009:1805-1818.
- Arruda V, High KA. Coagulation disorders. In: Fauci AS, ed. *Harrison's Principles of Internal Medicine*. 17th ed. New York: McGraw-Hill; 2008:725-730.
- Konkle BA. Disorders of platelets and vessel wall. In: Fauci AS, ed. *Harrison's Principles of Internal Medicine*. 17th ed. New York: McGraw-Hill; 2008:718-724.
- Schafer AI. Approach to the patient with bleeding and thrombosis. In: Goldman L, Ausiello D, eds. *Cecil Medicine*. 23rd ed. Philadelphia: Elsevier Saunders; 2008:1286-1288.
- Konkle BA. Bleeding and thrombosis. In: Fauci AS, ed. *Harrison's Principles of Internal Medicine*. 17th ed. New York: McGraw-Hill; 2008:363-369.
- Baz R, Mekhail T. Bleeding disorders. In: Carey WD, ed. *Current Clinical Medicine 2009 - Cleveland Clinic*.

- Philadelphia: Elsevier Saunders; 2009:669-674.
16. Schmaier AH. Laboratory evaluation of hemostatic and thrombotic disorders. In: Hoffman R, Furie B, McGlave P, eds. *Hematology: Basic Principles and Practice*. 5th ed. Philadelphia: Churchill Livingstone, Elsevier; 2009:1877-1884.
 17. Plauchu H, Dupuis-Girod S. [Hereditary hemorrhagic telangiectasia]. *Rev Prat*. 2009;59(7):899-903.
 18. Rees MM, Rodgers GM. Bleeding disorders caused by vascular abnormalities. In: Lee GR, Foerster J, Lukens J, et al, eds. *Wintrobe's Clinical Hematology*. 10th ed. Philadelphia: Lippincott Williams & Wilkins; 1999:1633-1648.
 19. Shuman M. Hemorrhagic disorders: abnormalities of platelet and vascular function. In: Goldman L, Ausiello D, eds. *Cecil Textbook of Medicine*. Philadelphia: Saunders; 2004:1060-1069.
 20. McMillan R. Hemorrhagic disorders: abnormalities of platelet and vascular function. In: Goldman L, Ausiello D, eds. *Cecil Medicine*. 23rd ed. Philadelphia: Elsevier Saunders; 2008:1289-1300.
 21. Grandinetti LM, Tomecki KJ. Dermatologic signs of systemic disease. In: Carey WD, ed. *Current Clinical Medicine 2009 - Cleveland Clinic*. Philadelphia: Saunders Elsevier; 2009:244-256.
 22. Lebrin F, Srun S, Raymond K, et al. Thalidomide stimulates vessel maturation and reduces epistaxis in individuals with hereditary hemorrhagic telangiectasia. *Nat Med*. 2010;16(4):420-428.
 23. Nurden AT. Qualitative disorders of platelets and megakaryocytes. *J Thromb Haemost*. 2005;3(8):1773-1782.
 24. Freson K, Labarque V, Thys C, et al. What's new in using platelet research? To unravel thrombopathies and other human disorders. *Eur J Pediatr*. 2007;166(12):1203-1210.
 25. Eckstein J, Filip D, Watts J. Hereditary thrombocytopenia, deafness, and renal disease. *Ann Intern Med*. 1975;82:639-645.
 26. Greinacher A, Mueller-Eckhardt C. Hereditary types of thrombocytopenia with giant platelets and inclusion bodies in the leukocytes. *Blut*. 1990;60:53-60.
 27. Doubek M, Smejkal P, Dostálová V, et al. Hereditary thrombocytopenia. Differential diagnosis of a case. *Cas Lek Cesk*. 2003;142:683-686.
 28. Pham A, Wang J. Bernard-Soulier syndrome: an inherited platelet disorder. *Arch Pathol Lab Med*. 2007;131(12):1834-1836.
 29. Streif W, Knofler R, Eberl W. Inherited disorders of platelet function in pediatric clinical practice: a diagnostic challenge. *Klin Padiatr*. 2010;222(3):203-208.
 30. Noris P, Klersy C, Zecca M, et al. Platelet size distinguishes between inherited macrothrombocytopenias and immune thrombocytopenia. *J Thromb Haemost*. 2009;7(12):2131-2136.
 31. Mezzano D, Quiroga T, Pereira J. The level of laboratory testing required for diagnosis or exclusion of a platelet function disorder using platelet aggregation and secretion assays. *Semin Thromb Hemost*. 2009;35(2):242-254.
 32. Bennett JS. Inherited and acquired disorders of platelet function. In: Young NS, Gerson SL, High KA, eds. *Clinical Hematology*. St. Louis: Elsevier - Mosby; 2006:767-781.
 33. Tefre KL, Ingerslev J, Sorensen B. Clinical benefit of recombinant factor VIIa in management of bleeds and surgery in two brothers suffering from the Bernard-Soulier syndrome. *Haemophilia*. 2009;15(1):281-284.
 34. Di Minno G, Coppola A, Di Minno MN, et al. Glanzmann's thrombasthenia (defective platelet integrin alphaIIb-beta3): proposals for management between evidence and open issues. *Thromb Haemost*. 2009;102(6):1157-1164.
 35. Depner C, Schmid R, Kirchoff P, et al. Perioperative management of Glanzmann's syndrome: how we did it! *Blood Coagul Fibrinolysis*. 2010;21(3):283-284.
 36. Kannan M, Saxena R. Glanzmann's thrombasthenia: an overview. *Clin Appl Thromb Hemost*. 2009;15(2):152-165.
 37. Sebastiano C, Bromberg M, Breen K, et al. Glanzmann's thrombasthenia: report of a case and review of the literature. *Int J Clin Exp Pathol*. 2010;3(4):443-447.
 38. Erduran E, Aksoy A, Zaman D. The use of recombinant FVIIa in a patient with Glanzmann thrombasthenia with uncontrolled bleeding after tonsillectomy. *Blood Coagul Fibrinolysis*. 2009;20(3):215-217.
 39. Javed A, Ayyub M, Abrar S, et al. Control of severe bleeding episode in case of Glanzmann's thrombasthenia refractory to platelet transfusion therapy by administering recombinant factor VIIa. *J Ayub Med Coll Abbottabad*. 2009;21(2):171-173.
 40. Lozier JN, Kessler GM. Clinical aspects and therapy of hemophilia. In: Hoffman R, Benz EJJ, Shattil SJ, et al, eds. *Hematology Basic Principles and Practices*. 4th ed. Philadelphia: Elsevier - Churchill Livingstone; 2005:2047-2071.
 41. McVey JH. Coagulation factors. In: Young NS, Gerson SL, High KA, eds. *Clinical Hematology*. St. Louis: Elsevier - Mosby; 2006:103-123.
 42. Ragni MV. The hemophilias: factor VIII and factor IX deficiencies. In: Young NS, Gerson SL, High KA, eds. *Clinical Hematology*. St. Louis: Elsevier - Mosby; 2006:814-830.
 43. Goldman L, Schafer AI. Goldman-Cecil medicine E-book. In: Goldman L, Schafer AI, eds. *Goldman-Cecil Medicine*. Philadelphia, PA: Elsevier (Saunders); 2016.
 44. Shord SS, Lindley CM. Coagulation products and their uses. *Am J Health-Syst Pharm*. 2000;57:1403-1418.
 45. Rodgers GM, Greenberg CS. Inherited coagulation disorders. In: Lee GR, Foerster J, Lukens J, et al, eds. *Wintrobe's Clinical Hematology*. 10th ed. Philadelphia: Lippincott Williams & Wilkins; 1999:1682-1733.
 46. Metjian A, Konkle BA. Inhibitors in hemophilia A and B. In: Hoffman R, Furie B, McGlave P, eds. *Hematology: Basic Principles and Practice*. 5th ed. Philadelphia: Churchill Livingstone, Elsevier; 2009:1931-1938.
 47. Rogers GL, Herzog RW. Gene therapy for hemophilia. *Front Biosci (Landmark Ed)*. 2015;20:556-603.
 48. Kessler CM. Hemorrhagic disorders: coagulation factor deficiencies. In: Goldman L, Ausiello D, eds. *Cecil*

- Textbook of Medicine*. Philadelphia: Saunders; 2004:1069-1078.
49. Roberts HR, Escobar MA. Other clotting factor deficiencies. In: Hoffman R, Benz EJJ, Shattil SJ, et al, eds. *Hematology Basic Principles and Practices*. 4th ed. Philadelphia: Elsevier - Churchill Livingstone; 2005:2081-2097.
50. Schafer AI. Thrombotic disorders: hypercoagulable states. In: Goldman L, Ausiello D, eds. *Cecil Medicine*. 23rd ed. Philadelphia: Elsevier Saunders; 2008: 1318-1323.
51. Bauer KA. Hypercoagulable states. In: Hoffman R, Furie B, McGlave P, eds. *Hematology: Basic Principles and Practice*. 5th ed. Philadelphia: Churchill Livingstone, Elsevier; 2009:2021-2042.
52. Van Cott EM, Khor B, Zehnder JL. Factor V Leiden. *Am J Hematol*. 2016;91(1):46-49.
53. Windyga J, Dolan G, Altisent C, et al. Practical aspects of DDAVP use in patients with von Willebrand Disease undergoing invasive procedures: a European survey. *Haemophilia*. 2016;22(1):110-120.
54. Scully C, Cawson RA. *Medical Problems in Dentistry*. 5th ed. Edinburgh: Elsevier; 2005.
55. Zulfikar B, Koc B, Ak G, et al. Surgery in patients with von Willebrand disease. *Blood Coagul Fibrinolysis*. 2016.

Cancer and Oral Care of Patients With Cancer

Collectively, all cancers combined account for about one quarter of deaths in the United States, thereby placing cancer second only to heart disease as a leading cause of death.¹

Cancer is a major public health problem in the United States as well as worldwide. Concordant with improvements in health and medical care resulting in increased longevity, the prevalence of cancer has increased over the past 50 years. In 2015, the probability of developing cancer from birth to death in the United States in men was 43.3% and 37.8% in women.^{2,3}

Because patients diagnosed with cancer are experiencing increased survival rates as a result of improved diagnostics and advances in antineoplastic therapy, an increased likelihood exists of dentists treating patients in various phases of cancer therapy. For optimal oral health, the dentist should be an integral part of the cancer patient's health care team. The characteristic clinical course, cancer progression status, treatment modalities, location of cancer therapy (hospital or outpatient facility), and likely outcome all will affect the dental treatment plan. Maintenance of proper oral hygiene is critical for limiting local and systemic complications associated with chemotherapy, radiation therapy, and bone marrow and stem cell transplantation. In addition, dentists have the unique opportunity to reduce the risk of cancer by providing advice regarding cancer screening and a healthy diet, counseling patients as appropriate regarding smoking cessation and risks associated with alcohol consumption, and performing cancer screening procedures.

This chapter focuses on common cancers that may affect patients who require dental care. No attempt is made here to include all cancers; instead, an overview of cancer is presented first followed by a discussion of common cancers, along with relevant considerations regarding oral care of patients with cancer. A discussion of lymphoma and leukemia can be found in [Chapter 23](#).

CRITICAL COMPLICATIONS: Patients for dental treatment with a risk of developing cancer or a history of cancer. The dentist must be aware of the type and extent of the cancer and prepare for complications such as adverse bleeding, side effects of drugs, and infection. These events could prove serious. The dentist must be able to detect these patients based on history and clinical findings, refer them for medical diagnosis and management, and work closely with the physician to develop a dental management plan that will be effective and safe for the patient.

EPIDEMIOLOGY

[Fig. 26.1](#) indicates the most common cancers expected to occur in men and women in 2015.^{1,2} Among men, cancers of the prostate, lung and bronchus, and colon and rectum account for more than 56% of all newly diagnosed cancers. In women, the most common cancers are breast, lung, colon, and uterine.³ A total of 1,658,370 new cancer cases and 589,430 cancer deaths were projected to occur in the United States in 2015 ([Table 26.1](#)). When deaths are aggregated by age, cancer has surpassed heart disease as the leading cause of death in those younger than age 85.^{1,2}

The death rate from all cancers combined has decreased slightly in the past 10 years.^{1,2} The mortality rate has also continued to decrease for the three most common cancer sites in men (lung and bronchus, colon and rectum, and prostate) and for breast and colon and rectum cancers in women^{1,2} ([Fig. 26.2](#)). Lung cancer mortality among women continues to increase slightly. As with many diseases, ethnic disparities exist. In analyses by race and ethnicity, African American men and women have 40% and 18% higher death rates from all cancers combined than do white men and women, respectively.^{1,2} Cancer incidence and death rates are lower in other racial and ethnic groups than in whites and African Americans for all sites combined and for the four major cancer sites. However, these groups generally have higher rates for stomach, liver, and cervical cancers than those reported for whites.^{1,2} Furthermore, minority populations are more likely than whites to be diagnosed with advanced-stage disease. Progress in reducing the burden of suffering and death from cancer can be accelerated by applying existing cancer control knowledge across all segments of the population.^{1,2}

Pathophysiology and Complications

Cancer is characterized by uncontrolled growth of aberrant neoplastic cells.^{4,5} Cancerous cells kill by destructive invasion of tissues—that is, direct extension and spread to distant sites by metastasis through blood, lymph, or serosal surfaces. Malignant cells arise from cells that have genetic and sometimes epigenetic alterations, such as gene mutations (both hereditary or acquired or somatic), chromosomal translocations, and over- or underexpression of factors (oncogenes, growth factor receptors, signal transducers, transcription factors) that cause cells to lose





Estimated New Cases				Estimated Deaths			
			Males	Females			
Prostate	220,800	26%			Breast	231,840	29%
Lung and bronchus	115,610	14%			Lung and bronchus	105,590	13%
Colon and rectum	69,090	8%			Colon and rectum	63,610	8%
Urinary bladder	56,320	7%			Uterine corpus	54,870	7%
Melanoma of the skin	42,670	5%			Thyroid	47,230	6%
Non-Hodgkin lymphoma	39,850	5%			Non-Hodgkin lymphoma	32,000	4%
Kidney and renal pelvis	38,270	5%			Melanoma of the skin	31,200	4%
Oral cavity and pharynx	32,670	4%			Pancreas	24,120	3%
Leukemia	30,900	4%			Leukemia	23,370	3%
Liver and intrahepatic bile duct	25,510	3%			Kidney and renal pelvis	23,290	3%
All sites	848,200	100%	All sites	810,170	100%		
Lung and bronchus	86,380	28%			Lung and bronchus	71,660	26%
Prostate	27,540	9%			Breast	40,290	15%
Colon and rectum	26,100	8%			Colon and rectum	23,600	9%
Pancreas	20,710	7%			Pancreas	19,850	7%
Liver and intrahepatic bile duct	17,030	5%			Ovary	14,180	5%
Leukemia	14,210	5%			Leukemia	10,240	4%
Esophagus	12,600	4%			Uterine corpus	10,170	4%
Urinary bladder	11,510	4%			Non-Hodgkin lymphoma	8,310	3%
Non-Hodgkin lymphoma	11,480	4%			Liver and intrahepatic bile duct	7,520	3%
Kidney and renal pelvis	9,070	3%			Brain and other nervous system	6,380	2%
All sites	312,150	100%	All sites	277,280	100%		

FIG 26.1 Ten leading cancer types in estimated new cancer cases and deaths, by gender, United States, 2015. Indicated are the most common cancers in men and women in 2015. Among men, cancers of the prostate, lung and bronchus, and colon and rectum account for more than 48% of all newly diagnosed cancers. Prostate cancer alone accounts for about 26% (220,800) of incident cases in men. Among women, cancers of the breast, lung and bronchus, and colon and rectum account for more than 50% of all newly diagnosed cancers. Breast cancer alone accounts for about 29% (231,840) of incident cases in women. (From Siegel RL, Miller KD, Jemal A: Cancer statistics, 2016, *CA Cancer J Clin* 66:5-29, 2016. © 2016 American Cancer Society.)

their ability to regulate deoxyribonucleic acid (DNA) synthesis and the cell cycle. Cellular abnormalities of malignancy result in three common features: uncontrolled proliferation, ability to recruit blood vessels (i.e., neo-vascularization), and ability to spread.^{4,5}

Carcinogenesis is a complex multistep process that involves the accumulation of mutations and the loss of regulatory control over cell division, differentiation, apoptosis, and adhesion^{4,5} (Fig. 26.3). Some syndromes that predispose individuals to cancer can be seen in Table 26.2.

The aggregation of cancer in a family can be due to genetic or epigenetic causes, the former through mendelian (single-gene mutation) or nonmendelian (polygenic or multifactorial) inheritance of genes that predispose to cancer and the latter related to common exposure to carcinogenic agents or lifestyle or simple coincidence.^{4,5} The modern understanding of familial aggregation of

cancer often violates the laws of mendelian inheritance and has required increasingly sophisticated epidemiologic and statistical methods in combination with genetic concepts and technologies.^{4,5} Some of the genetic associations with cancer are shown in Table 26.2.

At least three to six somatic mutations are needed to transform a normal cell into a malignant cell. Mutations can arise from exposure to hazardous chemicals and pathogens that lead to activation of oncogenes, inactivation of tumor suppressor genes (*pRb* and *TP53*), and chromosomal abnormalities (translocations, deletions, insertions).^{4,5} The accumulation of these abnormalities leads to a cell that becomes functionally independent and often aggressive. Natural killer (among other) cells provide surveillance for cancerous cells. Reduction in numbers or function of natural killer cells, which occurs during immunosuppression, increases the risk for cancer.^{4,5} National efforts currently focus on the reduction or

TABLE 26.1 Estimated New Cancer Cases and Deaths by Sex, United States, 2015*

	ESTIMATED NEW CASES			ESTIMATED DEATHS		
	Both Sexes	Male	Female	Both Sexes	Male	Female
All sites	1,658,370	848,200	810,170	589,430	312,150	277,280
Oral cavity and pharynx	45,780	32,670	13,110	8,650	6,010	2,640
Tongue	14,320	10,310	4,010	2,190	1,500	690
Mouth	12,920	7,750	5,170	2,120	1,200	920
Pharynx	15,520	12,380	3,140	2,660	2,010	650
Other oral cavity	3,020	2,230	790	1,680	1,300	380
Digestive system	291,150	163,050	128,100	149,300	86,540	62,760
Esophagus	16,980	13,570	3,410	15,590	12,600	2,990
Stomach	24,590	15,540	9,050	10,720	6,500	4,220
Small intestine	9,410	4,960	4,450	1,260	670	590
Colon [†]	93,090	45,890	47,200	49,700	26,100	23,600
Rectum	39,610	23,200	16,410			
Anus, anal canal, and anorectum	7,270	2,640	4,630	1,010	400	610
Liver and intrahepatic bile duct	35,660	25,510	10,150	24,550	17,030	7,520
Gallbladder and other biliary	10,910	4,990	5,920	3,700	1,660	2,040
Pancreas	48,960	24,840	24,120	40,560	20,710	19,850
Other digestive organs	4,670	1,910	2,760	2,210	870	1,340
Respiratory system	240,390	130,260	110,130	162,460	89,750	72,710
Larynx	13,560	10,720	2,840	3,640	2,890	750
Lung and bronchus	221,200	115,610	105,590	158,040	86,380	71,660
Other respiratory organs	5,630	3,930	1,700	780	480	300
Bones and joints	2,970	1,640	1,330	1,490	850	640
Soft tissue (including heart)	11,930	6,610	5,320	4,870	2,600	2,270
Skin (excluding basal and squamous)	80,100	46,610	33,490	13,340	9,120	4,220
Melanoma of the skin	73,870	42,670	31,200	9,940	6,640	3,300
Other nonepithelial skin	6,230	3,940	2,290	3,400	2,480	920
Breast	234,190	2,350	231,840	40,730	440	40,290
Genital system	329,330	231,050	98,280	58,670	28,230	30,440
Uterine cervix	12,900		12,900	4,100		4,100
Uterine corpus	54,870		54,870	10,170		10,170
Ovary	21,290		21,290	14,180		14,180
Vulva	5,150		5,150	1,080		1,080
Vagina other genital, female	4,070		4,070	910		910
Prostate	220,800	220,800		27,540	27,540	
Testis	8,430	8,430		380	380	
Penis other genital, male	1,820	1,820		310	310	
Urinary system	138,710	96,580	42,130	30,970	21,110	9,860
Urinary bladder	74,000	56,320	17,680	16,000	11,510	4,490
Kidney renal pelvis	61,560	38,270	23,290	14,080	9,070	5,010
Ureter other urinary organs	3,150	1,990	1,160	890	530	360
Eye orbit	2,580	1,360	1,220	270	140	130
Brain other nervous system	22,850	12,900	9,950	15,320	8,940	6,380
Endocrine system	64,860	16,520	48,340	2,890	1,350	1,540
Thyroid	62,450	15,220	47,230	1,950	870	1,080
Other endocrine	2,410	1,300	1,110	940	480	460
Lymphoma	80,900	44,950	35,950	20,940	12,140	8,800
Hodgkin lymphoma	9,050	5,100	3,950	1,150	660	490
Non-Hodgkin lymphoma	71,850	39,850	32,000	19,790	11,480	8,310
Myeloma	26,850	14,090	12,760	11,240	6,240	5,000
Leukemia	54,270	30,900	23,370	24,450	14,210	10,240
Acute lymphocytic leukemia	6,250	3,100	3,150	1,450	800	650
Chronic lymphocytic leukemia	14,620	8,140	6,480	4,650	2,830	1,820
Acute myeloid leukemia	20,830	12,730	8,100	10,460	6,110	4,350
Chronic myeloid leukemia	6,660	3,530	3,130	1,140	590	550
Other leukemia [‡]	5,910	3,400	2,510	6,750	3,880	2,870
Other and unspecified primary sites[‡]	31,510	16,660	14,850	43,840	24,480	19,360

*Rounded to the nearest 10; estimated new cases exclude basal cell and squamous cell skin cancers and in situ carcinoma except urinary bladder.

About 60,290 cases of carcinoma in situ of the female breast and 63,440 cases of melanoma in situ will be newly diagnosed in 2015.

[†]Estimated deaths for colon and rectum cancers are combined due to a high percentage of misclassification.

[‡]More deaths than cases may reflect lack of specificity in recording underlying cause of death on death certificates or an undercount in the case estimate.

From Siegel RL, Miller KD, Jemal A: Cancer statistics, 2016, *CA Cancer J Clin* 66:5-29, 2016. © 2016 American Cancer Society.

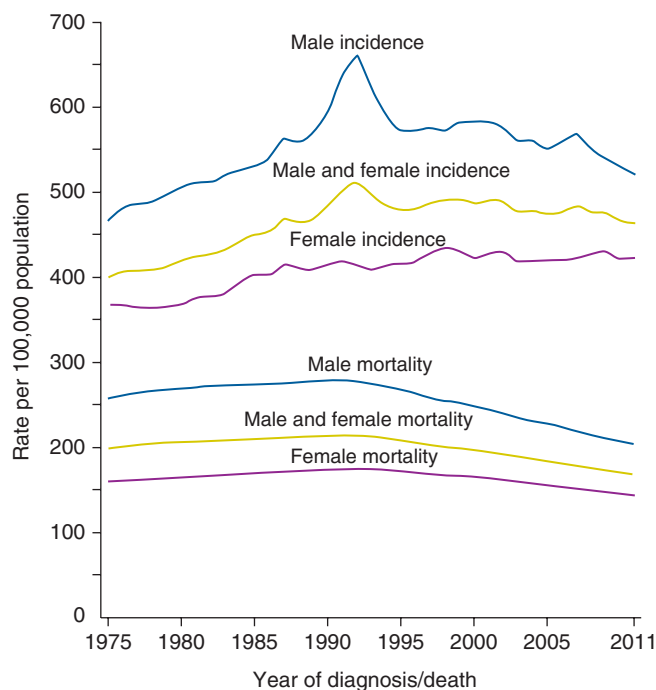

FIG 26.2 Cancer trends in incidence and mortality by sex, 2015.

elimination of factors known to be associated with cancer. Recommendations from the American Cancer Society (ACS) are to minimize exposure to tobacco smoke and to environmental and occupational carcinogens (e.g., asbestos fibers, arsenic compounds, chromium compounds, pesticides), decrease intake of fat and exposure to ultraviolet (UV) light, moderate the intake of alcohol, obtain an adequate intake of dietary fiber and antioxidants (vitamins C and E, selenium), and perform moderate levels of physical activity.^{5,6}

The loss of regulatory control in a cell destined to become a cancer cell in epithelial tissue results in a series of pathologic changes that eventuate in hyperproliferative epithelium, dysplasia, and finally carcinoma. Dysplastic tissue is characterized by atypical cell proliferation, nuclear enlargement, failure of maturation, and differentiation short of malignancy (see Fig. 26.3).^{4,5}

Cytogenetic studies of various leukemias established four cardinal attributes of genetic change in cancer: (1) Specific or nonrandom chromosomal changes may characterize individual cancer types; (2) tumor genomes are genetically unstable and subject to continuing change, a feature now recognized as genomic instability; (3) all cells in a given tumor trace back to a single progenitor cell

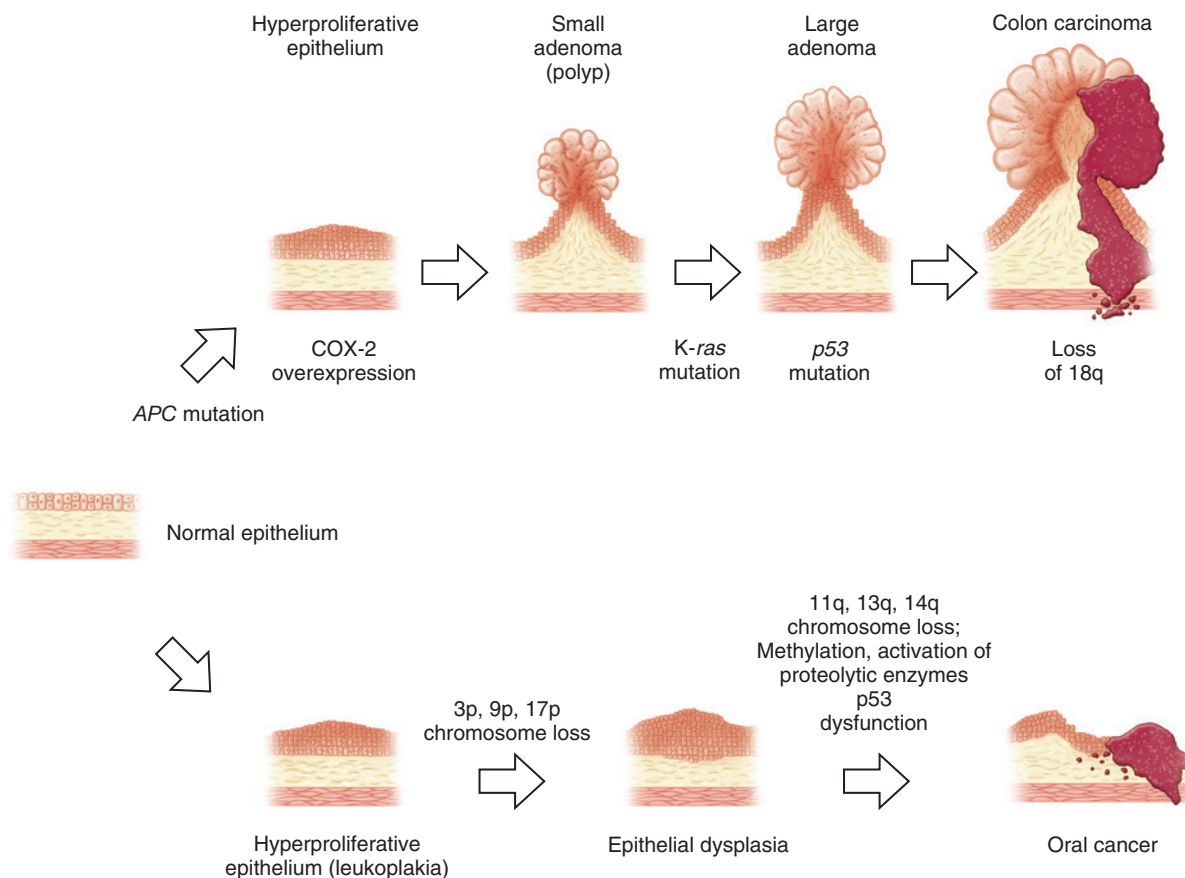

FIG 26.3 Carcinogenesis: pathologic sequence in gastrointestinal mucosa. Examples in colon and oral mucosa. *COX*, Cyclooxygenase. (Adapted from Jänne PA, Mayer RJ: Chemoprevention of colorectal cancer, *N Engl J Med* 342:1960-1968, 2000.)

TABLE 26.2 Syndromes of Inherited Cancer Predisposition in Clinical Oncology Syndrome

Syndrome	Mode of Inheritance	Gene(s)
HEREDITARY BREAST CANCER SYNDROMES		
Hereditary breast and ovarian cancer syndrome	Dominant	<i>BRCA1</i> <i>BRCA2</i>
Li-Fraumeni syndrome	Dominant	<i>TP53</i>
Cowden syndrome	Dominant	<i>PTEN</i>
Bannayan-Riley-Ruvalcaba syndrome	Dominant	<i>PTEN</i>
HEREDITARY GASTROINTESTINAL MALIGNANCIES		
Hereditary nonpolyposis colon cancer	Dominant	<i>MLH1</i> <i>MLH2</i> <i>MSH6</i>
Familial polyposis	Dominant	<i>APC</i>
Hereditary gastric cancer	Dominant	<i>CDH1</i>
Juvenile polyposis	Dominant	<i>SMAD4/DPC4</i> <i>BMPR1A</i>
Peutz-Jeghers syndrome	Dominant	<i>STK11</i>
Hereditary melanoma–pancreatic cancer syndrome	Dominant	<i>CDKN2A</i>
Hereditary pancreatitis	Dominant	<i>PRSS1</i>
Turcot syndrome	Dominant	<i>APC</i> <i>MLH1</i> <i>PMS2</i>
Familial gastrointestinal stromal tumor	Dominant	<i>KIT</i>
GENODERMATOSES WITH CANCER PREDISPOSITION		
Melanoma syndromes	Dominant	<i>CDKN2A</i> <i>CDK4</i> <i>CMM</i>
Basal cell cancer, Gorlin syndrome	Dominant	<i>PTCH</i>
Cowden syndrome	Dominant	<i>PTEN</i>
Neurofibromatosis 1	Dominant	<i>NF1</i>
Neurofibromatosis 2	Dominant	<i>NF2</i>
Tuberous sclerosis	Dominant	<i>TSC1</i> <i>TSC2</i>
Carney complex	Dominant	<i>PRKAR1A</i>
Muir-Torre syndrome	Dominant	<i>MLH1</i> <i>MSH2</i>
Xeroderma pigmentosum	Recessive	<i>XPA,B,C,D,E,F,G</i> <i>POLH</i>
Rothmund-Thomson syndrome	Recessive	<i>RECQL4</i>
LEUKEMIA OR LYMPHOMA PREDISPOSITION SYNDROMES		
Bloom syndrome	Recessive	<i>BLM</i>
Fanconi anemia	Recessive	<i>FANCA,B,C</i> <i>FANCA,D2</i> <i>FANCE,F,G</i> <i>FANCL</i>
Ataxia-telangiectasia	Recessive	<i>ATM</i>
Shwachman-Diamond syndrome	Recessive	<i>SBDS</i>
Nijmegen breakage syndrome	Recessive	<i>NBS1</i>
Canale-Smith syndrome	Dominant	<i>FAS</i> <i>FASL</i>
Wiskott-Aldrich syndrome	X-linked recessive	<i>WAS</i>
Common variable immune deficiency	Recessive	

TABLE 26.2 Syndromes of Inherited Cancer Predisposition in Clinical Oncology Syndrome—cont'd

Syndrome	Mode of Inheritance	Gene(s)
Severe combined immune deficiency	X-linked recessive Recessive	<i>IL2RG</i> <i>ADA</i> <i>JAK3</i> <i>RAG1</i> <i>RAG2</i> <i>IL7R</i> <i>CD45</i> <i>Artemis</i>
X-linked lymphoproliferative syndrome	X-linked recessive	<i>SH2D1A</i>
GENITOURINARY CANCER PREDISPOSITION SYNDROMES		
Hereditary prostate cancer	Dominant	<i>HPC1</i> <i>HPCX</i> <i>HPC2/ELAC2</i> <i>PCAP</i> <i>PCBC</i> <i>PRCA</i>
Simpson-Golabi-Behmel syndrome	X-linked recessive	<i>GPC3</i>
von Hippel-Lindau syndrome	Dominant	<i>VHL</i>
Beckwith-Wiedemann syndrome	Dominant	<i>CDKN1C</i> <i>NSD1</i>
Wilms tumor syndrome	Dominant	<i>WT1</i>
Wilms tumor, aniridia, genitourinary abnormalities, mental retardation (WAGR) syndrome	Dominant	<i>WT1</i>
Birt-Hogg-Dub syndrome	Dominant	<i>FLCL</i>
Papillary renal cancer syndrome	Dominant	<i>MET,PRCC</i>
Constitutional t(3;8) translocation	Dominant	<i>TRCB</i>
Hereditary bladder cancer	Sporadic	
Hereditary testicular cancer	Possibly X-linked	
Rhabdoid predisposition syndrome	Dominant	<i>SNF5/INI1</i>
CENTRAL NERVOUS SYSTEM OR VASCULAR CANCER PREDISPOSITION SYNDROMES		
Hereditary paraganglioma	Dominant	<i>SDHD</i> <i>SDHC</i> <i>SDHB</i>
Retinoblastoma	Dominant	<i>RB1</i>
Rhabdoid predisposition syndrome	Dominant	<i>SNF5/INI1</i>
SARCOMA OR BONE CANCER PREDISPOSITION SYNDROMES		
Multiple exostoses	Dominant	<i>EXT1</i> <i>EXT2</i>
Leiomyoma/renal cancer syndrome	Dominant	<i>FH</i>
Carney complex	Dominant	<i>PRKAR1A</i>
Werner syndrome	Recessive	<i>WRN</i>
ENDOCRINE CANCER PREDISPOSITION SYNDROMES		
Multiple endocrine neoplasia 1	Dominant	<i>MEN1</i>
Multiple endocrine neoplasia 2	Dominant	<i>RET</i>
Familial papillary thyroid cancer	Dominant	<i>Multiple loci</i>

Adapted from Garber JE, Offit K: Hereditary cancer predisposition syndromes, *J Clin Oncol* 23:276-292, 2005.

and therefore are clonal; and (4) tumor progression often is associated with additional specific or nonrandom chromosomal changes, presumably “selected” from the genomic instability, in subpopulations of tumor cells that lead clonal diversity and evolution.^{4,5} Chromosomal changes are of many types, the most common being gain

or loss of an entire chromosome (aneuploidy) or a region of it (duplication), loss of an entire chromosome (monosomy) or a region of it (deletion), translocation or inversion (rearrangement), and amplification (Fig. 26.4).^{4,5}

Malignant cells exhibit antigenic, karyotypic, biochemical, and membrane changes that cause loss of contact

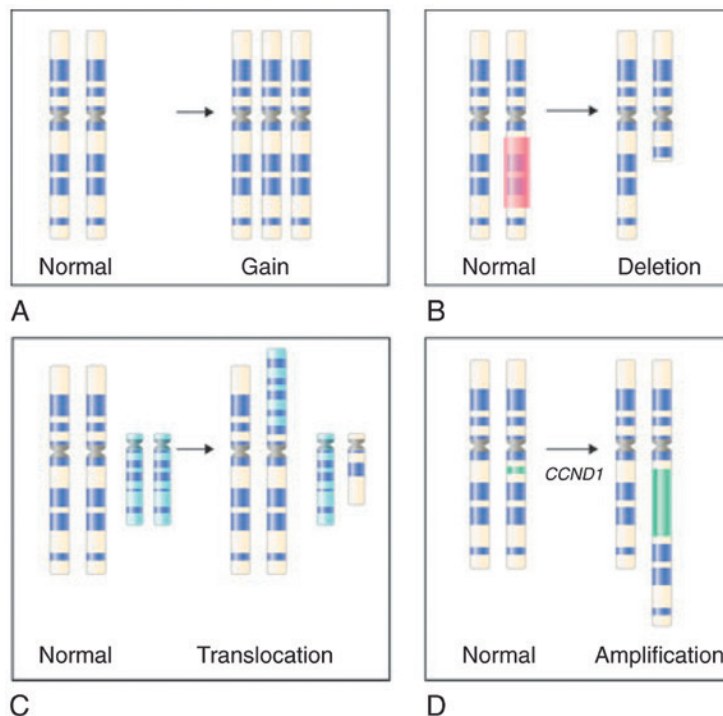

FIG 26.4 Common cytogenetic changes in cancer. The chromosome (at metaphase) is traditionally distinguished by its short and long arms separated by a centromere. Stylized bands (*dark and light stripes* along the length of the chromosome) produced by special treatments are also shown. The abnormality (*right*) and the corresponding normal image of the chromosome are illustrated in each panel. **A**, Gain of a chromosome leading to aneuploidy. **B**, Deletion of a chromosomal segment from one of the two homologues. **C**, Translocation showing exchange of segments between nonhomologous chromosomes. **D**, Amplification, with an increase in a region of a chromosome by replicating many times in place. (From Goldman L, Ausiello D, editors: *Cecil textbook of medicine*, ed 23, Philadelphia, 2008, Saunders.)

inhibition, changes in chromosomal morphology, and increased permeability.^{4,5} Malignant tumors lack cell cycle control and replicate rapidly, becoming clinically detectable after about 30 cell doublings, when the mass contains about 10^9 cells (1 g). A 3-log increase to 10^{12} cells produces a tumor that weighs 1 kg and often is lethal. After reaching clinically detectable size, tumors slow in growth as they reach anatomic boundaries and begin to outgrow their blood supply.^{4,5} Malignant tumors overcome the limitation of anatomic boundaries by losing cell adherence and by metastasizing. Metastasis is a distinct form of cancerous spread that occurs when malignant cells enter blood or lymphatic vessels and travel to distant sites. Metastasis is related to factors produced by tumor cells that allow individual cells to invade tissues and endothelium. It often results in end-organ failure and death.^{4,5}

CLINICAL PRESENTATION

Screening

Each year, the ACS publishes a summary of its recommendations for early cancer detection. Table 26.3 demonstrates the history of cancer screening recommendations over the years. Obviously, the earlier any form of cancer

is diagnosed, the more expeditiously and effectively it can be treated in order to minimize adverse outcomes: morbidity and mortality. Additionally, cancer screening recommendations are developed by the U.S. Preventive Services Task Force (USPSTF) for most cancers.^{3,5,7-9} For the most part, these are similar.

Table 26.4 outlines the most recent ACS (2015) recommendations for early cancer detection for several cancers.^{3,5,7-9} Further information can be found at <http://cacancerjournal.org>.

For comparison, Tables 26.5 and 26.6 outline the USPSTF recommendations for screening for breast and cervical cancer. The legend explaining the screening accompanies the tables. Further information may be found at <http://www.uspreventiveservicestaskforce.org/Page/Document/UpdateSummaryFinal/breast-cancer-screening>.

The ACS recommends these cancer screening guidelines for most adults. Screening tests are used to find cancer before a person has any symptoms.³

Breast Cancer

- **Women ages 40 to 44 years** should have the choice to start annual breast cancer screening with mammograms (x-rays of the breast) if they wish to do so.

TABLE 26.3 History of Recommendations of the American Cancer Society

Cancer Site	Year	References
Breast cancer	2003: Complete update	Smith (2003) ³
	2007: Guidelines for MRI use in high-risk women	Saslow (2007) ⁴
	2015: Update anticipated	
Cervical cancer	2002: Complete update	Saslow (2002) ⁵
	2007: Guidelines for HPV vaccine use	Saslow (2007) ⁶
	2012: Complete update	Saslow (2012) ⁷
Colorectal cancer	2015: Update related to follow-up of HPV-negative ASC-US	In this article
	2001: Complete update	Smith (2001) ⁸
	2003: Technology update	Levin (2003) ⁹
	2006: Update for postpolypectomy and postcolorectal cancer resection surveillance	Rex (2006), ¹⁰ Winawer (2006) ¹¹
	2008: Complete update	Levin (2008) ¹²
Endometrial cancer	2016: Update anticipated	
	2001: Guidance for counseling, shared decision making, and high-risk women	Smith (2001) ⁸
Prostate cancer	2001: Guidance for shared decision making related to testing for early detection and screening recommendations for higher risk men	Smith (2001) ⁸
Lung cancer	2010: Complete update	Wolf (2010) ¹³
	2001: Guidance for shared decision making	Smith (2001) ⁸
	2011: Interim guidance on lung cancer screening	ACS, (2011) ¹⁴
	2013: Complete update	Wender (2013) ¹⁵

ACS, American Cancer Society; ASC-US, atypical squamous cells of undetermined significance; HPV, human papillomavirus; MRI, magnetic resonance imaging.

- **Women ages 45 to 54 years** should get mammograms every year.
- **Women 55 years and older** should switch to mammograms every 2 years or can continue yearly screening.
- Screening should continue as long as a woman is in good health and is expected to live 10 more years or longer.
- **All women** should be familiar with the known benefits, limitations, and potential harms linked to breast cancer screening. They also should know how their breasts normally look and feel and report any breast changes to a health care provider right away.

Some women—because of their family history, a genetic tendency, or certain other factors—should be screened with magnetic resonance imaging (MRI) along with mammograms. (The number of women who fall into this category is very small.) Women should talk with their

health care providers about their risk for breast cancer and the best screening plan for them.

Colon and Rectal Cancer and Polyps. Starting at age 50 years, both men and women should follow one of these testing plans:

Tests That Find Polyps and Cancer

- Flexible sigmoidoscopy every 5 years* or
- Colonoscopy every 10 years or
- Double-contrast barium enema every 5 years* or
- Computed tomography (CT) colonography (virtual colonoscopy) every 5 years*

Tests That Mostly Find Cancer

- Yearly guaiac-based fecal occult blood test (gFOBT)[†] or
- Yearly fecal immunochemical test (FIT)[†] or Stool DNA test (sDNA), every 3 years*

The tests that can find both early cancer and polyps should be the patient's first choice if these tests are available and he or she is willing to have one of them. Patients should talk to their health care providers about which test is best for them.

If a patient is at high risk of colon cancer based on family history or other factors, he or she may need to be screened using a different schedule. Patients should talk to their health care providers about which test is best for them.

Cervical Cancer

- Cervical cancer testing should start at age 21 years. Women younger than age 21 years should not be tested.
- Women between the ages of 21 and 29 years should have a Pap test done every 3 years. Human papillomavirus (HPV) testing should not be used in this age group unless it is needed after an abnormal Pap test result.
- Women between the ages of 30 and 65 years should have a Pap test plus an HPV test (called “co-testing”) done every 5 years. This is the preferred approach, but it's acceptable to have a Pap test alone every 3 years.
- **Women older than age 65 years** who have had regular cervical cancer testing in the past 10 years with normal results should not be tested for cervical cancer. When testing is stopped, it should not be started again. Women with a history of a serious cervical precancer should continue to be tested for at least 20 years after that diagnosis even if testing goes past age 65 years.
- **A woman who has had her uterus and cervix removed (a total hysterectomy)** for reasons not related to cervical cancer and who has no history of cervical cancer or serious precancer should not be tested.
- **All women who have been vaccinated against HPV** should still follow the screening recommendations for their age groups.

*If the test result is positive, a colonoscopy should be done.

[†]The multiple stool take-home test should be used. One test done in the office is not enough. A colonoscopy should be done if the test result is positive.

TABLE 26.4 Screening Recommendations of the American Cancer Society*

Cancer Site	Population	Test or Procedure	Frequency
Breast	Women aged ≥ 20 years	Self-examination (is an option)	Every month
	Women aged 20–39 years	Clinical examination	Every 3 years
	Women aged ≥ 40 years	Clinical examination	Every year
	Women aged 40–49 years	Mammography	Every year
	Women aged ≥ 50 years	Mammography	Every year
Colon	Men and women, aged ≥ 50 years	Sigmoidoscopy	Every 3–5 years
		Fecal occult blood test	Every year
Cervix	Men and women, aged ≥ 40 years	Digital rectal examination	Every year
	Women aged ≥ 18 years	Pelvic examination	Every year [†]
		Papanicolaou test	Every year
Prostate	Men, aged ≥ 50 years (if average risk); aged ≥ 45 years (if high risk); aged ≥ 40 years (if very high risk)	Prostate examination Blood tests for prostate-specific antigen	Every year
Health counseling and cancer checkups	Men and women, aged ≥ 20 years	To include examination for cancers of the thyroid, testicles, ovaries, lymph nodes, oral cavity, and skin, as well as health counseling about tobacco, sun exposure, diet and nutrition, risk factors, sexual practices, and environmental and occupational exposures	Every year

*These recommendations often are applied 5 to 10 years earlier for specific cancers in persons with a family history of cancer and when specific racial (e.g., African American) populations are at increased risk.

[†]With three or more consecutive satisfactory normal annual examinations, screening may be performed less frequently.

Data from Smith RA, Cokkinides V, Brooks D, et al: Cancer screening in the United States, 2011: a review of current American Cancer Society guidelines and issues in cancer screening, *CA Cancer J Clin* 61:8-30, 2011.

TABLE 26.5 U.S. Preventive Services Task Force Recommendations for Screening for Breast Cancer

Archived: Recommendation Summary Summary of Recommendations		
Population	Recommendation	Grade (What's This?)
Women, Age 50-74 Years	The USPSTF recommends biennial screening mammography for women 50-74 years.	B
Women, Before the Age of 50 Years	The decision to start regular, biennial screening mammography before the age of 50 years should be an individual one and take patient context into account, including the patient's values regarding specific benefits and harms.	C
Women, 75 Years and Older	The USPSTF concludes that the current evidence is insufficient to assess the benefits and harms of screening mammography in women 75 years and older. Go to the Clinical Considerations section for information on risk assessment and suggestions for practice regarding the I statement.	I
All Women	The USPSTF recommends against <i>teaching</i> breast self-examination (BSE).	D
Women, 40 Years and Older	The USPSTF concludes that the current evidence is insufficient to assess the additional benefits and harms of clinical breast examination (CBE) beyond screening mammography in women 40 years or older. Go to the Clinical Considerations section for information on risk assessment and suggestions for practice regarding the I statement.	I
All Women	The USPSTF concludes that the current evidence is insufficient to assess the additional benefits and harms of either digital mammography or magnetic resonance imaging (MRI) instead of film mammography as screening modalities for breast cancer. Go to the Clinical Considerations section for information on risk assessment and suggestions for practice regarding the I statement.	I

TABLE 26.6 US Preventive Services Task Force Recommendations for Screening for Cervical Cancer

Recommendation Summary

Summary of Recommendations and Evidence

Population	Recommendation	Grade (What's This?)
Women 21 to 65 (Pap smear) or 30-65 (in combo with HPV testing)	The USPSTF recommends screening for cervical cancer in women age 21 to 65 years with cytology (Pap smear) every 3 years or, for women age 30 to 65 years who want to lengthen the screening interval, screening with a combination of cytology and human papillomavirus (HPV) testing every 5 years. See the Clinical Considerations for discussion of cytology method, HPV testing, and screening interval.	A
Women younger than 30 years, HPV testing	The USPSTF recommends against screening for cervical cancer with HPV testing, alone or in combination with cytology, in women younger than age 30 years.	D
Women younger than 21	The USPSTF recommends against screening for cervical cancer in women younger than age 21 years.	D
Women older than 65, who have had adequate prior screening	The USPSTF recommends against screening for cervical cancer in women older than age 65 years who have had adequate prior screening and are not otherwise at high risk for cervical cancer. See the Clinical Considerations for discussion of adequacy of prior screening and risk factors.	D
Women who have had a hysterectomy	The USPSTF recommends against screening for cervical cancer in women who have had a hysterectomy with removal of the cervix and who do not have a history of a high-grade precancerous lesion (cervical intraepithelial neoplasia [CIN] grade 2 or 3) or cervical cancer.	D

What the Grades Mean and Suggestions for Practice

The USPSTF updated its definition of and suggestions for practice for the grade C recommendation. This new definition applies to USPSTF recommendations voted on after July 2012. Describing the strength of a recommendation is an important part of communicating its importance to clinicians and other users. Although most of the grade definitions have evolved since the USPSTF first began, none has changed more noticeably than the definition of a C recommendation, which has undergone three major revisions since 1998. Despite these revisions, the essence of the C recommendation has remained consistent: At the population level, the balance of benefits and harms is very close, and the magnitude of net benefit is small. Given this small net benefit, the USPSTF has either not made a recommendation “for or against routinely” providing the service (1998), recommended “against routinely” providing the service (2007), or recommended “selectively” providing the service (2012). Grade C recommendations are particularly sensitive to patient values and circumstances. Determining whether or not the service should be offered or provided to an individual patient will typically require an informed conversation between the clinician and patient.

Grade	Definition	Suggestions for Practice
A	The USPSTF recommends the service. There is high certainty that the net benefit is substantial.	Offer or provide this service.
B	The USPSTF recommends the service. There is high certainty that the net benefit is moderate or there is moderate certainty that the benefit is moderate to substantial.	Offer or provide this service.
C	The USPSTF recommends selectively offering or providing this service to individual patients based on professional judgment and patient preferences. There is at least moderate certainty that the net benefit is small.	Offer or provide this service for selected patients depending on individual circumstances.
D	The USPSTF recommends against the service. There is moderate or high certainty that the service has no net benefit or that the harms outweigh the benefits.	Discourage the use of this service.
I Statement	The USPSTF concludes that the current evidence is insufficient to assess the balance of benefits and harms of the service. Evidence is lacking, of poor quality, or conflicting, and the balance of benefits and harms cannot be determined.	Read the Clinical Considerations section of USPSTF Recommendation Statement. If the service is offered, patients should understand the uncertainty about the balance of benefits and harms.

Some women, because of their medical history (e.g., HIV infection, organ transplant, DES exposure), may need a different screening schedule for cervical cancer. Patients should talk to their health care providers about their medical history.

Endometrial (Uterine) Cancer. The ACS recommends that at the time of menopause, all women should be told about the risks and symptoms of endometrial cancer. Women should report any unexpected vaginal bleeding or spotting to their doctors.

Some women, because of their history, may need to consider having a yearly endometrial biopsy. Patients should talk to their health care providers about their medical history.

Lung Cancer. The ACS does not recommend tests to check for lung cancer in people who are at average risk. But the ACS does have screening guidelines for those who are at high risk of lung cancer because of cigarette smoking. Screening might be right if a patient is all of the following:

- 55 to 74 years of age
- In good health
- Has at least a 30 pack-year smoking history *and* is either still smoking or has quit smoking within the past 15 years (A pack-year is the number of cigarette packs smoked each day multiplied by the number of years a person has smoked. Someone who smoked a pack of cigarettes per day for 30 years has a 30 pack-year smoking history, as does someone who smoked 2 packs a day for 15 years.)

Screening is done with an annual low-dose CT scan (LDCT) of the chest. If a patient fits this list, he or she should talk to a health care provider to start screening.

Prostate Cancer. The ACS recommends that men make an informed decision with a health care provider about whether to be tested for prostate cancer. Research has not yet proven that the potential benefits of testing outweigh the harms of testing and treatment. We believe that men should not be tested without first learning about what we know and do not know about the risks and possible benefits of testing and treatment.

Starting at 50 years of age, men should talk to a health care provider about the pros and cons of testing so they can decide if testing is the right choice for them.

If a patient is African American or has a father or brother who had prostate cancer before age 65 years, he should have this talk with a health care provider starting at age 45 years.

If a patient decides to be tested, he should get a prostate-specific antigen (PSA) blood test with or without a rectal examination. How often a patient is tested will depend on his PSA level.

Cancer-Related Checkups

For people age 20 years of age or older who get periodic health examinations, a cancer-related checkup should

include health counseling and, depending on a person's age and gender, examinations for cancers of the thyroid, oral cavity, skin, lymph nodes, testes, and ovaries, as well as for some other diseases besides cancer.

Cancers often manifest as a palpable mass that increase in size over time. Preceding the development of the tumor are subtle changes that are dependent on the anatomic site involved and the cell type of origin. Initial features can include a change in surface color, a lump, enlarged lymph node, or altered organ function. Symptoms can include pain and paresthesia. Tumors permitted to increase in size often result in a reddened epithelial surface (caused by increased blood vessels) that ulcerates.⁴⁻⁶

Staging. Most cancers are assigned a stage (I, II, III, or IV) by the medical team on the basis of the size of the tumor and how far it has spread (Box 26.1).⁶⁻⁸ Generically speaking, stage I disease is localized and confined to the organ of origin. Stage II disease is regional, affecting nearby structures. Regional head and neck lymph node anatomy can be seen in Fig. 26.5. Stage III disease extends

BOX 26.1 International Tumor–Node–Metastasis (TNM) System of Classification and Staging of Oral Carcinomas

T: Tumor Size

- T_{IS}, carcinoma in situ
- T₁, tumor ≤2 cm in size
- T₂, tumor >2 cm up to 4 cm in size
- T₃, tumor >4 cm in size
- T₄, massive tumor with deep invasion into bone, muscle, skin

N: Regional Lymph Node Involvement

- N₀, no palpable nodes
- N₁, single, homolateral palpable node ≤3 cm in diameter
- N₂, single, homolateral palpable node, 3 to 6 cm or multiple, homolateral nodes, none >6 cm
- N₃, single or multiple, homolateral nodes, one >6 cm, or bilateral nodes (stage each side of neck), or contralateral nodes

M: Metastases

- M₀, no known distant metastasis
- M₁, distant metastasis—PUL (pulmonary), OSS (osseous), HEP (liver), BRA (brain)

Stage Classification

0 (carcinoma in situ)	T _{IS} , N ₀ , M ₀
I	T ₁ , N ₀ , M ₀
II	T ₂ , N ₀ , M ₀
III	T ₃ , N ₀ , M ₀ or T ₁ , T ₂ or T ₃ , N ₁ , M ₀
IVA	T ₄ , N ₀ , M ₀ or T ₄ , N ₁ , M ₀ or any T, N ₂ , M ₀
IVB	Any T, N ₃ , M ₀
IVC	Any T, any N, M ₁

Adapted from Sobin L, Gospodarowicz M, Wittekind C, editors: *UICC TNM classification of malignant tumours*, ed 7, Hoboken, NJ, 2010, Wiley-Blackwell.

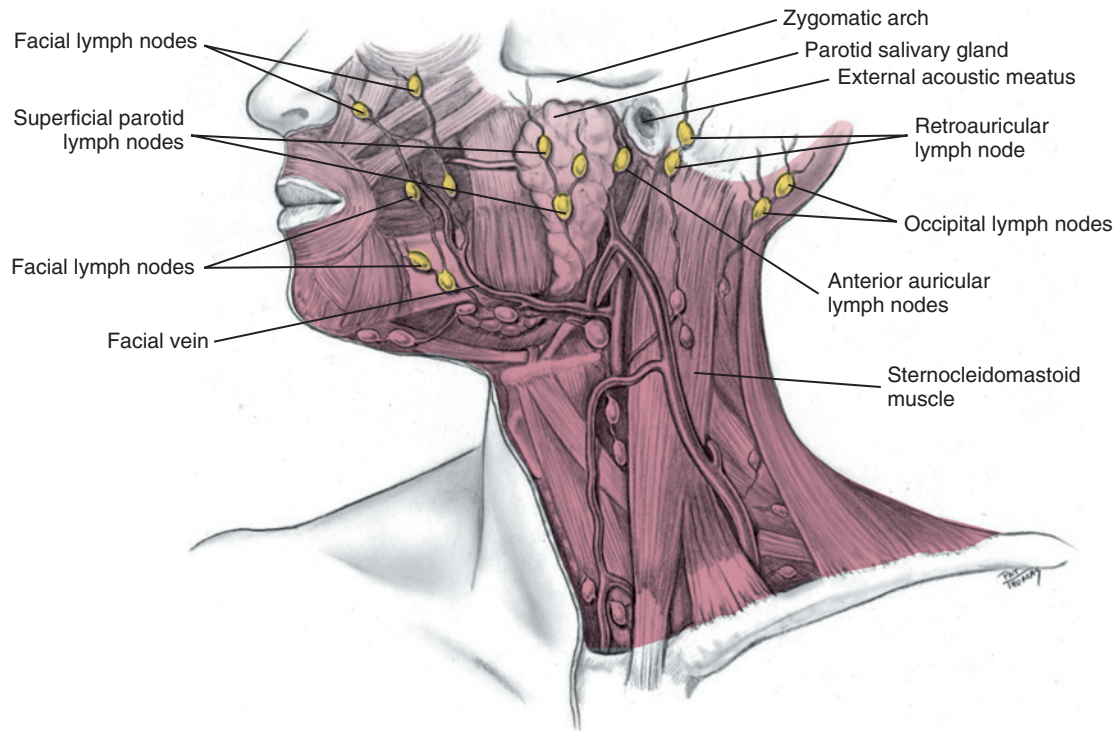

A

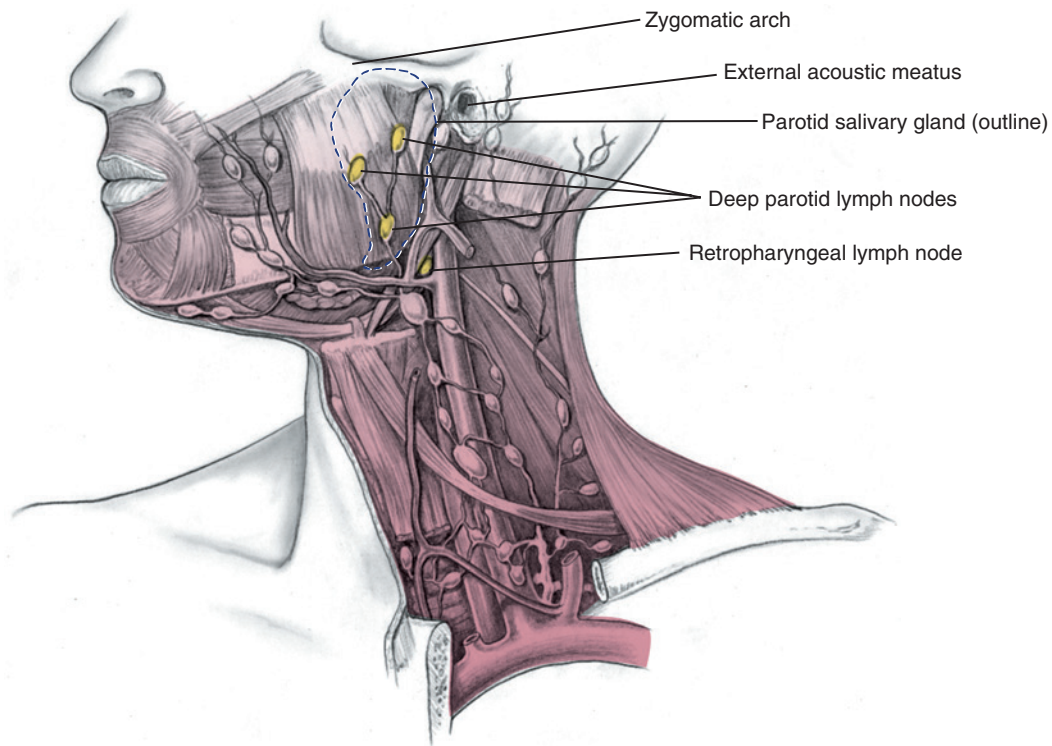

B

FIG 26.5 Regional lymph node anatomy. (From Fehrenbach MJ, Herring SW: *Illustrated anatomy of the head and neck*, ed 4, St. Louis, 2012, Saunders.)

beyond the regional site, crossing several tissue planes, and stage IV disease is widely disseminated. This system often is supplemented by detailed and specific staging systems developed for particular cancers and generally does not apply to leukemia and other myeloproliferative cancers (because leukemia is a disease of the blood cells that does not usually form a solid mass or tumor).⁶⁻⁸ The tumor–node–metastasis (TNM) system frequently is used for this purpose (see [Box 26.1](#)). The patient's prognosis depends in large part on the stage of disease at the time of diagnosis.^{3,5,7-9}

Laboratory and Diagnostic Findings

The diagnosis of cancer is dependent on microscopic examination of an adequate sample of tissue taken from the tumor ([Box 26.2](#)).^{4,6} Tissue can be obtained by cytologic smears, needle biopsy, or incisional or excisional biopsy. Cells also can be subjected to flow cytometry, chromosomal analyses, in situ hybridization, or other molecular procedures to identify specific cancer markers, ploidy, and DNA analysis.^{4,6} Serum tumor markers such as carcinoembryonic antigen (CEA) for colorectal carcinoma, cancer antigen 15-3 (CA 15-3) or CEA in breast cancer, and CA 125 for ovarian cancer have low sensitivity for the detection of early-stage cancers but are useful in monitoring disease progression and response to therapy.^{4,6}

MEDICAL MANAGEMENT

Treatment strategies for cancer are based on eliminating fast multiplying cancer cells without killing the host.^{4,6} Therapeutic modalities include surgery; irradiation (by external beam or implants); regimens based on cytotoxic, chemotherapeutic, and endocrine drugs; and possibly stem cell or bone marrow transplantation.^{4,6} Surgery often is used when anatomy permits or if the cancer is limited in size. Radiation therapy (often at doses >50 grays [Gy]⁷) kills cells by damaging cancer cell DNA and chromosomes needed for cell replication and is used when surgery alone is insufficient or contraindicated, or for cancers that are radiosensitive.^{4,6} Chemotherapeutic agents are most effective against rapidly growing tumors by adversely affecting the DNA synthesis or protein synthesis of cancerous cells.⁶⁻⁸ A wide range of cancer chemotherapeutic compounds

exist. They are divided into several categories: alkylating agents, antimetabolites, hormones, antibiotics, mitotic inhibitors, and miscellaneous drugs ([Table 26.7](#)).^{4,6} Tumorcidal efficacy is gained with use of these various agents in combination. High-dose multidrug protocols are used in hospital settings to induce myelosuppression for patients with leukemia, lymphoma (see [Chapter 23](#)), and, more recently, breast cancer who are scheduled to undergo bone marrow transplantation. Opportunistic infections are a major concern during the myelosuppressive period. Patients who receive outpatient chemotherapy are administered a lower-dose regimen on a 3- to 4-week schedule and are at lower risk for opportunistic infections.^{4,6}

TABLE 26.7 Chemotherapy Drugs of Choice for Common Cancers

Cancer	Drugs of Choice
Breast	Risk reduction: tamoxifen Adjuvant: doxorubicin + cyclophosphamide ± fluorouracil followed by paclitaxel; cyclophosphamide + methotrexate + fluorouracil; tamoxifen for receptor-positive and hormone-responsive tumors Metastatic: doxorubicin + cyclophosphamide ± fluorouracil; cyclophosphamide + methotrexate + fluorouracil Tamoxifen or toremifene for receptor-positive and/or hormone-responsive tumors Paclitaxel + trastuzumab for tumors that overexpress HER2 protein
Cervix	Locally advanced: cisplatin ± fluorouracil Metastatic: cisplatin; ifosfamide with mesna; bleomycin + ifosfamide with mesna + cisplatin
Colorectal	Adjuvant: fluorouracil + leucovorin Metastatic: fluorouracil + leucovorin + irinotecan
Head and neck	Cisplatin + fluorouracil or paclitaxel
Kaposi sarcoma	Liposomal doxorubicin or daunorubicin; doxorubicin + bleomycin + vincristine
Leukemia and lymphoma	See Table 24.2
Liver	Hepatic intraarterial floxuridine, cisplatin, doxorubicin or mitomycin
Lung	
Non–small cell	Paclitaxel + cisplatin or carboplatin; cisplatin + vinorelbine; gemcitabine + cisplatin; cisplatin or carboplatin + etoposide
Small cell	
Melanoma	Adjuvant: interferon alfa Metastatic: dacarbazine
Multiple myeloma	Melphalan or cyclophosphamide + prednisone; vincristine + doxorubicin (Adriamycin) + dexamethasone
Prostate	Gonadotropin-releasing hormone agonists (leuprolide or goserelin) ± antiandrogen (flutamide, bicalutamide, or nilutamide)
Renal	Interleukin-2

Adapted from National Cancer Institute. Drugs approved for head and neck cancer. <http://www.cancer.gov/about-cancer/treatment/drugs/head-neck>.

BOX 26.2 Microscopic Criteria for Malignancy

Cytoplasm: Scant cytoplasm, increased nucleus to cytoplasm ratio, tight molding of cytoplasmic membrane around nucleus

Nucleus: Enlargement with variation in size, irregular membrane with sharp angles, hyperchromasia, irregular chromatin distribution with clumping, prominent nucleoli, abundant or abnormal mitotic figures

Relationships: Variation in cell size and shape, abnormal stratification, decreased cohesiveness

Breast Cancer

Breast cancer is the most common type of cancer in the United States, with 98% of cases occurring in women. In 2015, approximately 235,000 cases of breast cancer were reported in the United States, with about 40,000 persons dying of the disease in that year.^{1,2} The incidence increases with age. Risk factors include early menarche, late menopause, and nulliparity (women who do not bear children). All breast cancers are the result of somatic genetic abnormalities. The most important risk factor of breast cancer is family history of the disease with 5% to 10% of cases arising in high-risk families.^{1,2,5,8} The most common mutations identified in breast cancer cells are in the *BRCA1* and *BRCA2* genes. These mutations confer a 50% to 85% lifetime risk of breast cancer. Abnormalities also have been identified in genes (*bcl-2*, *c-myc*, *c-myb* and *TP53*) and gene products (Her2/neu and cyclin D1) that regulate the cell cycle and DNA replication.^{1,2,5,8} Gonadal steroid hormones, growth factors, and various chemokines (e.g., interleukin-6) influence the behavior and dissemination of the disease. Cancer in one breast increases the risk for cancer development in the other.^{1,2,5,8-10}

Breast cancer often is detected as a lump in the breast with or without nipple discharge, breast skin changes, and breast pain. Mammography detects the mass in only 75% to 85% of patients (Fig. 26.6).^{1,2,5,8-10} Although mammography recently has been controversial, it is still a valuable screening technique as considered by the ACS.¹¹ The USPSTF recommends biennial screening mammography for women 50 to 74 years of age.⁸ In a small percentage of patients, the first sign is an axillary mass. Diagnosis is made from a tissue core biopsy of breast tissue. Most breast cancers are infiltrating ductal carcinomas; a smaller percentage of tumors are infiltrating lobular carcinomas, medullary carcinomas, mucinous carcinoma, or tubular carcinoma. Metastasis occurs after the cancer becomes clinically detectable and is primarily to regional lymph nodes and within the chest wall, bone, lung, and liver.⁸⁻¹²

Treatment of breast cancer is quite complicated and depends on the histologic type of cancer as well as stage.^{5,8-12} Cellular markers such as the Her2/neu molecule (target of drug Herceptin) and the sodium-iodide symporter (NIS) aid in the diagnosis and treatment planning.^{5,8-12} Lumpectomy (when the tumor is <5 cm) or lumpectomy plus radiotherapy is preferred over radical mastectomy. Axillary node dissection is performed if the regional sentinel node is positive for malignancy. Hormone therapy (tamoxifen) and chemotherapy combined with local therapy is recommended when invasive carcinoma exceeds 1 cm in diameter or axillary lymph nodes are positive.^{5,8-12} The combination of fluorouracil, doxorubicin, and cyclophosphamide usually is administered for 4 to 6 months, given at 3- to 4-week intervals. At present, metastatic breast cancer is incurable.^{5,8-12} Accordingly, the ACS recommends a mammogram and professional clinical examination every year for women 40 years of

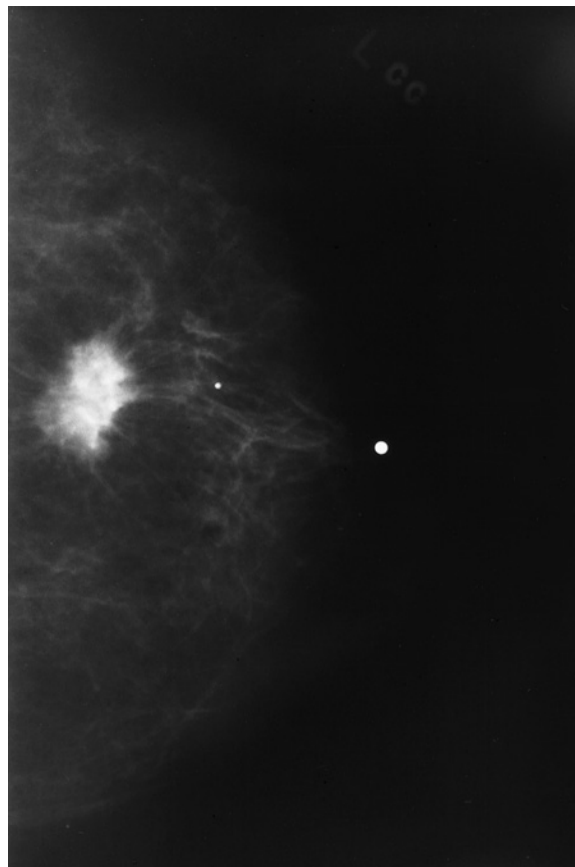

FIG 26.6 Mammogram showing a radiodense area in the breast suggestive of a malignancy that should be recommended for biopsy. (Courtesy of A.R. Moore, Lexington, KY.)

age and older (Box 26.3; see also Table 26.5). Women 20 to 39 years of age should have a professional breast examination at least every 3 years. Breast self-examination is an option for women starting in their 20s.⁸

Cervical Cancer

Cancer of the uterine cervix occurred in nearly 13,000 women in the United States in 2015, and more than 4000 women died of the disease.^{1,2,9} Cervical cancer is relatively uncommon in developed countries because of the intensive screening programs in place. Since the widespread use of screening Papanicolaou (Pap) smears, which detect asymptomatic cancerous precursor lesions at early stages, the incidence of cervical cancer has decreased dramatically, from 32 cases per 100,000 women in the 1940s to 8.3 cases per 100,000 women at present.^{1,2,9} However, approximately 30% of these patients die of the disease within 5 years, and the death rate for African Americans is more than twice the national average.^{9,13-15}

Human papillomaviruses, which are epitheliotropic sexually transmitted DNA viruses, are the major etiologic agent of cervical carcinogenesis.^{13,14} These viruses dysregulate the cell cycle and tumor suppressor genes (*TP53* and *pRb*) through overexpression of viral early genes E6 and E7.^{9,13-15} Certain HPV strains (HPV serotypes 16, 18,

BOX 26.3 National Comprehensive Cancer Network Guidelines for Breast Cancer Treatment

Clinical Stage	Workup	
Stage I T1, N0, M0 or Stage IIA T0, N1, M0 T1, N1, M0 T2, N0, M0 or Stage IIB T2, N1, M0 T3, N0, M0 or Stage IIIA T3, N1, M0	<ul style="list-style-type: none"> • History and physical exam • Diagnostic bilateral mammogram; ultrasound as necessary • Pathology review^a • Determination of tumor estrogen/progesterone receptor (ER/PR) status and HER2 status^b • Genetic counseling if patient is high risk for hereditary breast cancer^c • Breast MRI^d (optional), with special consideration for mammographically occult tumors • Counseling for fertility concerns if premenopausal^e • Assess for distress^f <p>For clinical stage I-IIB, consider additional studies only if directed by signs or symptoms:^g</p> <ul style="list-style-type: none"> • CBC • Liver function tests and alkaline phosphatase • Bone scan indicated if localized bone pain or elevated alkaline phosphatase • Abdominal ± pelvic diagnostic CT or MRI indicated if elevated alkaline phosphatase, abnormal liver function tests, abdominal symptoms, or abnormal physical examination of the abdomen or pelvis • Chest diagnostic CT (if pulmonary symptoms present) <p>If clinical stage IIIA (T3, N1, M0) consider:</p> <ul style="list-style-type: none"> • CBC • Liver function tests and alkaline phosphatase • Chest diagnostic CT • Abdominal ± pelvic diagnostic CT or MRI • Bone scan or sodium fluoride PET/CT^h (category 2B) • FDG PET/CT^{i,j} (optional, category 2B) 	See Locoregional Treatment ^k (BINV-2)

^aThe panel endorses the College of American Pathologists Protocol for pathology reporting for all invasive and noninvasive carcinomas of the breast. <http://www.cap.org>.

^bSee Principles of HER2 Testing (BINV-A).

^cSee NCCN Guidelines for Genetic/Familial High-Risk Assessment: Breast and Ovarian.

^dSee Principles of Dedicated Breast MRI Testing (BINV-B).

^eSee Fertility and Birth Control (BINV-C).

^fSee NCCN Guidelines for Distress Management.

^gRoutine systemic staging is not indicated for early breast cancer in the absence of symptoms.

^hIf FDG PET/CT is performed and clearly indicates bone metastasis, on both the PET and CT component, bone scan or sodium fluoride PET/CT may not be needed.

ⁱFDG PET/CT can be performed at the same time as diagnostic CT. The use of PET or PET/CT scanning is not indicated in the staging of clinical stage I, II, or operable stage III breast cancer. FDG PET/CT is most helpful in situations where standard staging studies are equivocal or suspicious, especially in the setting of locally advanced or metastatic disease.

^jFDG PET/CT may also be helpful in identifying unsuspected regional nodal disease and/or distant metastases in locally advanced breast cancer when used in addition to standard staging studies.

^kSee NCCN Guidelines for Older Adult Oncology for special treatment considerations.

45, and 56) are classified as high-risk types because they are associated with a majority of cases. HPV types 30, 31, 33, 35, 39, 45, 51, 52, 56, 58, 59, and 66 are classified as intermediate oncogenic risk.^{9,13-15} In addition to viral infection, chronic cigarette smoking, multiple sexual partners, and immunosuppression increase the risk of cervical cancer.^{9,13-15}

Cervical cancer typically has a long asymptomatic period before the disease becomes clinically evident. The cancer classically manifests in women who are between 40 and 60 years of age. The earliest preinvasive changes are diagnosed by Pap smear along with HPV testing.^{9,13-15} Further evaluation is made by colposcopy and colposcopy-directed biopsy (Fig. 26.7). If neoplastic cells penetrate the underlying basement membrane of the uterine cervix,

widespread dissemination can occur. Metastases often affect renal tissues, resulting in ureteral obstruction and azotemia. Treatment is based on the stage of the disease and involves hysterectomy in the early stages and radiation therapy for disease that extends to or invades local organs. The 5-year survival rate is relatively high (see Table 26.1) but drops below 50% when the cancer extends to and beyond the pelvic wall.^{9,13-15}

The ACS recommends that a Pap smear and professional pelvic examination be performed in women at the onset of sexual activity or at 18 years of age.³ The USPSTF recommends screening for cervical cancer in women age 21 to 65 years with cytology (Pap smear) every 3 years or, for women age 30 to 65 years who want to lengthen the screening interval, screening with a combination of

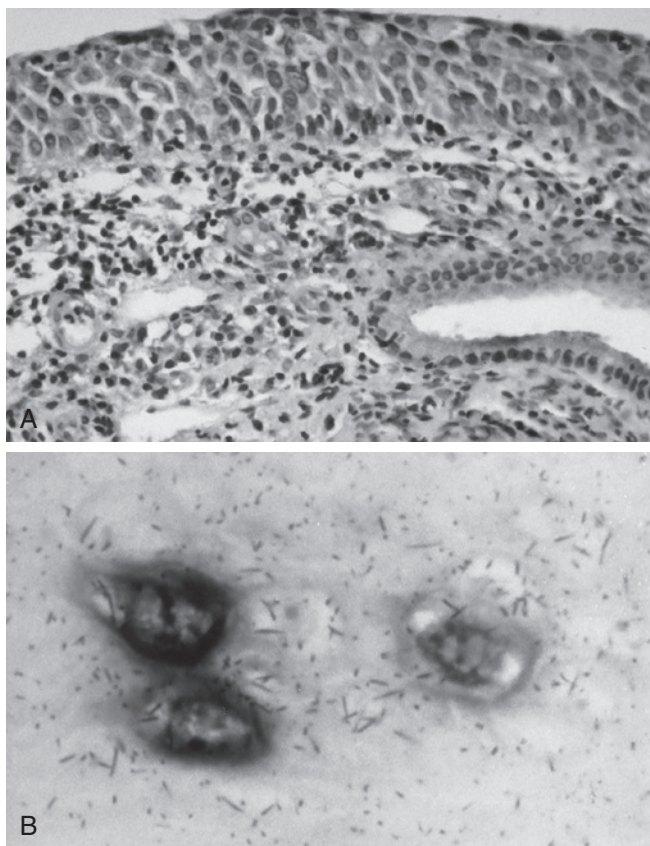

FIG 26.7 **A**, Biopsy specimen revealing cancerous epithelium of the uterine cervix (hematoxylin and eosin stain). **B**, Human papillomavirus DNA detected in cervical epithelium by in situ hybridization. (Courtesy of Dr. Michael Cibull, Lexington, KY.)

cytology and HPV testing every 5 years.⁹ Because cervical cancer is associated with immunosuppression, the Centers for Disease Control and Prevention (CDC) advises all women who are seropositive for human immunodeficiency virus (HIV) to receive semiannual screening beginning the first year after diagnosis. Health care providers may elect to screen less often when results of three annual examinations in a row are negative.^{9,13-15}

Colorectal Cancer

Cancer of the large bowel (colon and rectum) is the most common malignancy of the gastrointestinal tract and overall the fourth most common cancer of persons living in the United States. This cancer was diagnosed in approximately 140,000 persons in the United States in 2015, and nearly 60,000 people died of the disease in that year.^{1,2,16,17} Colorectal cancer accounts for about 10% of all cancers in the United States and carries a 5-year survival rate of 61%.^{1,2,16,17} Over the past 2 decades, the mortality rate has decreased for white women and men but increased in African American men and women.^{16,17}

The vast majority of colorectal cancers are adenocarcinomas (Fig. 26.8).^{16,17} Inherited predisposition and environmental factors contribute to their development.

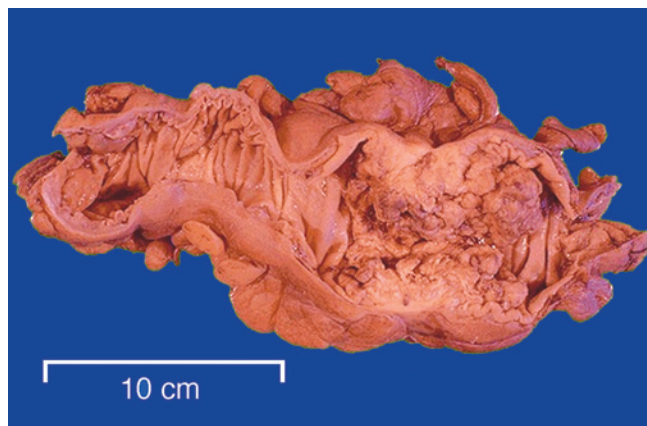

FIG 26.8 Destructive effects of colon cancer. (From Klatt ED: *Robbins and Cotran atlas of pathology*, ed 2, Philadelphia, 2010, Saunders.)

Genetic abnormalities in chromosome 5 (in familial adenomatous polyposis), chromosome 17 (*TP53* gene), and chromosome 18 (*DCC* gene) are contributory.^{5,16,17} An initiating and probably obligatory event is the oncogenic activation of the adhesion protein, beta-catenin, resulting from its overexpression, or loss of its negative regulator, the adenomatous polyposis cancer protein (APC). These abnormalities result in an upregulation in cell cycle signaling.^{5,16,17} Patients with chronic inflammation (ulcerative colitis) have approximately 10 to 20 times the risk of colorectal cancer as in the general population.^{5,16,17} The risk also increases with high-fat diet (40% of total calories), low dietary fiber intake, and smoking cigarettes for 20 years or more.^{5,16,17} By contrast, use of nonsteroidal antiinflammatory drugs (NSAIDs) and folate supplementation reduces the risk for colorectal cancer.^{5,16-18} Colonic adenomas (polyps) have malignant potential; however, fewer than 5% develop into carcinomas. The exception to this rule is in Gardner syndrome, in which virtually all affected patients develop malignant polyposis by age 40 years unless treated.^{17,18}

Colorectal cancer often is not diagnosed until age 40 years and increases in incidence after age 50 years. Risk rises sharply by age 60 years and doubles every decade until it peaks at age 75 years.¹⁷ Spread is by direct extension through the bowel wall and invasion of adjacent organs by lymphatics and the portal vein to the liver. The major signs and symptoms of colorectal cancer are rectal bleeding, abdominal pain, and change in bowel habits (constipation). Presenting symptoms may include those referable to invasion of adjacent organs (kidney, liver, vagina).¹⁷⁻¹⁹ Screening for colorectal cancer as recommended by the ACS is summarized in Table 26.4.

Colonoscopy is the preferred approach for evaluating a patient for colorectal cancer. This approach permits tissue and brush biopsy to be performed. Staging of the patient is aided by endoscopic ultrasonography and computed tomography (CT) scanning.¹⁷⁻²⁰ Surgical excision

is the treatment of choice with lesions encroaching the distal 5 cm of the colon, resulting in colostomy. Radiation therapy is used for treatment of rectal and anal cancer. Chemotherapy (fluorouracil and leucovorin for up to 6 months or, more recently, topoisomerase I inhibitors [camptothecins] and oxaliplatin) is used when metastatic spread occurs. Liver metastases have been treated with hepatic arterial therapy using implantable pumps and injection ports to deliver chemotherapeutic agents.¹⁷⁻²⁰

The poor prognosis with advanced colorectal cancer (stage III or IV) emphasizes the need for annual screening of at-risk adults. Digital rectal examination (DRE), fecal occult blood test, stool DNA testing, sigmoidoscopy, colonoscopy, and barium enema with air contrast are the screening procedures for colorectal cancer.¹⁷⁻²⁰ The ACS recommends that screening start at age 50 years for both men and women and even earlier if a family history exists, especially among first-degree relatives of colorectal cancer, preexisting inflammatory bowel disease, a personal history of colorectal cancer or adenomatous polyp, or a family history of hereditary colorectal cancer syndromes (e.g., familial adenomatous polyposis, Peutz-Jeghers syndrome, Gardner syndrome).³ DRE and a test for occult blood should be performed once a year.^{3,4} Sigmoidoscopy is recommended every 5 years and colonoscopy every 10 years. A barium enema can be performed in place of the sigmoidoscopy and colonoscopy.¹⁷⁻²⁰

Lung Cancer

Lung cancer is the cause of 14% of cancer cases (>225,000 cases in 2015) and is the leading cause of cancer deaths (almost 160,000 deaths annually) in the United States (see Table 26.1).¹⁻³ Although it maintains a similar incidence with breast and prostate cancer, the number of deaths caused by lung cancer exceeds the other two combined.¹⁻³ The number of new cases has been declining in men since 1984; by contrast, the incidence in women increased in the 1980s and 1990s and only recently declined. Lung cancer is more prevalent in industrialized countries, but increased incidence in nonindustrialized countries has resulted from the introduction of cigarettes into these regions.¹⁻³ Overall, more than 85% of cases are related to smoking tobacco with a dose-dependent effect. In 60% of human lung cancers, the p53 tumor suppressor gene is mutated.^{5,21-23} Current evidence suggests that polycyclic aromatic hydrocarbons (e.g., benzopyrene metabolite) of tobacco smoke form adducts within the TP53 gene that contribute to an abnormally functioning p53. Deletions in chromosomal 3p and 9p and overexpression of the *ras* and *myc* oncogenes and growth factor receptor c-erbB-2 appear to be important steps in malignant transformation. Risk of lung cancer increases in persons who are exposed to certain inorganic minerals (asbestos and crystalline silica), metals (arsenic, chromium, and nickel), and ionizing radiation (e.g., radon).^{5,21-23}

Histologically, lung cancers are divided into two groups. About 80% are non-small cell lung cancers (large cell

undifferentiated 10%; squamous cell carcinoma [SCC] 30%; and adenocarcinoma 40%) (Fig. 26.9), and 20% are small cell lung cancers (i.e., oat cell carcinoma). Small cell cancers have a rapid growth rate and metastasize early.^{5,22,23}

Lung cancer is a clinically silent disease until late in its course. Tumors that grow locally can produce a cough or change the nature of a chronic cough or manifest as dyspnea on exertion. Cancers that invade adjacent structures can produce chest pain and dyspnea, hemoptysis, or syndromes (e.g., Horner syndrome) from disruption of nerves in the chest and neck or endocrine, cutaneous, or neurologic manifestations.²² Metastases to the brain, bone, adrenal gland, and liver produce features associated with malfunction of these organs and lymphadenopathy. With advanced disease, patients present with anorexia, weight loss, weakness, and profound fatigue.²²

Unfortunately, so far there is not any lung cancer screening test that has been shown to prevent people from dying of this disease.³ The use of chest x-ray imaging and sputum cytology (evaluating phlegm microscopically for abnormal cells) has been studied for several years. The recently updated studies have not yet yielded any value in screening programs for the early detection of lung cancer.^{3,23} The USPSTF recommends annual screening

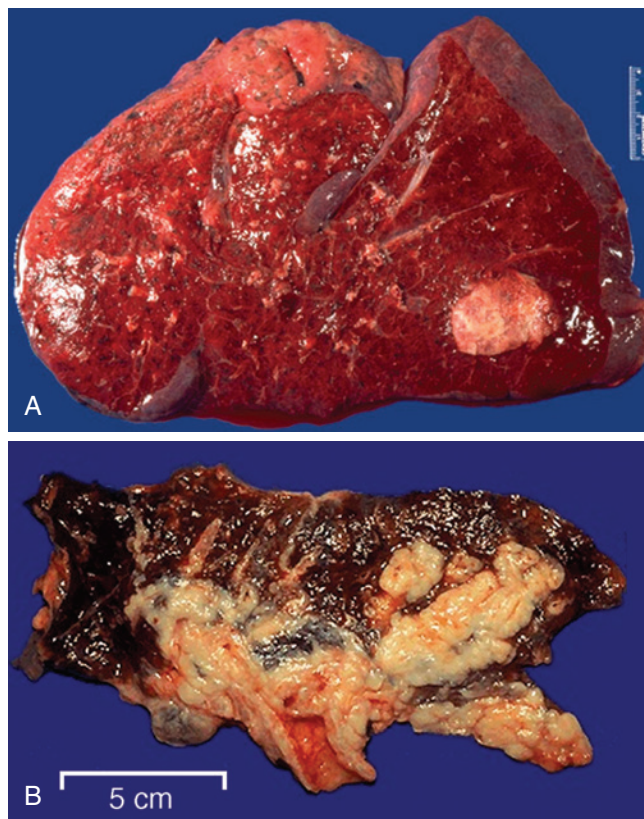

FIG 26.9 **A** and **B**, Large cell undifferentiated carcinoma infiltrating the entire lung shown in cross-section. (From Klatt ED: *Robbins and Cotran atlas of pathology*, ed 2, Philadelphia, 2010, Saunders.)

for lung cancer with low-dose computed tomography (LDCT) in adults aged 55 to 80 years who have a 30 pack-year smoking history and currently smoke or have quit within the past 15 years. Screening should be discontinued after a person has not smoked for 15 years or develops a health problem that substantially limits life expectancy or the ability or willingness to have curative lung surgery.²⁴

The diagnosis of lung cancer is made by imaging studies, bronchoscopy, bronchial washings, brush and tissue biopsies, and histologic examination of the cells and tissue. Stage I and stage II non-small cell lung cancers are treated by surgical resection. Radiotherapy is used for more advanced non-small cell lung cancers and when patients with stage I or II disease refuse or are medically unfit for surgery.^{6,19,24} Chemotherapy using two or three agents (e.g., cisplatin, carboplatin, etoposide, vinblastine, vindesine) is used in combination with radiotherapy for stage III and stage IV non-small cell lung cancers.^{19,24} Chemotherapy is the mainstay of treatment for small cell lung cancer.¹⁹ Adjuvant radiotherapy is used in patients with limited disease.¹⁹ Stage I lung cancer and stage II squamous cell lung cancers are associated with 5-year survival rates of more than 50%. The current 5-year survival rate for all stages of lung cancer is just 15.8%.^{19,24} Despite the poor prognosis, national recommendations have not been made in the United States to deploy diagnostic image screening for the detection of lung cancer even in high-risk persons.^{19,24}

Prostate Cancer

Prostate cancer is the second most common cancer ($\approx 221,000$ cases per year) and the most common cancer of men in the United States (see [Table 26.1](#)). It is the second leading cause of cancer deaths among men (nearly 28,000 per year).^{1,2} Prostate cancer develops in approximately 9% of white men and in 11% of African American men. Family history and race (African American) are definitive risk factors for the development of this disease.^{1,2,25}

At present, the etiologic factors for prostate cancer remain unknown. High dietary fat intake and mutations in chromosome 1 (1q24-25) and X (Xq27-28) appear to increase the risk for prostate cancer. Overexpression of the *c-myc* oncogene also is commonly detected in solid tumors such as prostate cancer.^{1,2,25}

More than 90% of all prostate carcinomas are adenocarcinomas.²⁵ They typically arise at multiple locations within the gland. Cancer of the prostate produces few signs and symptoms other than problems in urination (hesitancy, decreased force of urination) that, if present, occur late in the course of the disease.^{1,2,25} Thus, screening procedures are paramount to the successful management of this disease.^{3,4,25,26} Methods used to screen for prostate cancer include the DRE in combination with blood tests for PSA, and endorectal ultrasound imaging (see also [Table 26.4](#)).²⁶ The PSA velocity (change in the PSA level

over time) aids in the diagnosis. The upper normal level for the PSA is 4 ng/mL. Transrectal ultrasound-guided needle biopsy is recommended for patients with the following findings.^{25,26}

- PSA value greater than 10 ng/mL
- A positive DRE (palpable nodule or abnormality); even if the PSA value is less than 4 ng/mL, a positive DRE represents about 25% of all prostate cancers
- PSA value between 4 and 10 ng/mL and a negative DRE
- PSA value less than 4 ng/mL, a negative DRE result, and a PSA value that has increased from 1 year to the next by 0.75 ng/mL (PSA velocity) or more

Radionuclide scanning or pelvic MRI is recommended for men diagnosed with prostate cancer with a PSA greater than 10 ng/mL to determine the extent of the disease. Metastasis occurs by lymphatic or hematogenous dissemination. Lymphatic spread is usually to thoracic and pelvic regions. Hematogenous spread is usually to bone. Bony metastasis is often identified in the pelvis, spine, and femur ([Fig. 26.10](#)).^{25,26}



FIG 26.10 Radionuclide scan showing increased uptake of technetium at sites of bony metastasis from prostate cancer. (Courtesy of Dale A. Miles, DDS, Fountain Hills, AZ.)

Treatment options include radical prostatectomy, external-beam radiation, interstitial seed radiation, and cryosurgery. Androgen deprivation therapy is offered in cases of more advanced disease. Prognosis correlates with the histologic grade and stage of the tumor, with persons who have limited disease (stage I) having the best prognosis.^{25,26}

Skin Cancer

Of the three primary types of skin cancer, basal cell carcinoma is the most common type followed by SCC (discussed under “Oral Cancer”) and melanoma. There were approximately 75,000 new cases of melanoma in the United States in 2015 (see [Table 26.1](#)).^{1,2} Basal cell carcinoma accounts for about 80,000 new cases annually in the United States. These are slow-growing, locally invasive tumors that arise in the basal layer of epithelium, generally as a result of chromosomal changes caused by chronic exposure to UV light (particularly UVB radiation).^{27,28} Evidence suggests that mutation plus inactivation of the human “patched” gene located in chromosome 9 (9q22.3) probably is a requirement for the development of basal cell carcinoma.^{5,27}

Basal cell carcinomas are more common in older persons with lighter skin and blond or red hair. However, diagnosis in the second and third decades of life is becoming more common.^{5,27} About 85% of these lesions appear on sun-exposed surfaces of the head and neck (including the lip). Four types of basal cell carcinomas are recognized: nodular, superficial, sclerosing (morpheaform), and pigmented. Each type manifests as a gradually evolving local growth. Classically, the nodular basal cell carcinoma is a pearly papule with telangiectasias, a rolled waxy border, and a central ulceration (“rodent ulcer”) ([Fig. 26.11](#)).^{5,27,28} A history of intermittent encrustation and bleeding is common. The less common types appear reddish, pigmented, or scarlike. Basal cell carcinomas are readily removed with cryotherapy and surgical excision.^{27,28} Contemporary therapy results in greater than a 95% cure rate.^{27,28} Because basal cell

carcinomas are locally invasive and destructive, preventive measures that include reduced sun exposure and frequent examination of sun-exposed skin by a health care provider are important in preventing recurrences. Inadequate treatment results in spread to deeper structures, but rarely do these tumors metastasize.^{27,28}

Melanoma is a malignant neoplasm arising from melanocytes.^{27,29} This cancer occurs primarily in skin but can occur at any site where melanocytes are found, including the oral cavity. The incidence of melanoma is increasing faster than any other cancer, with approximately 75,000 new cases of melanoma reported in the United States annually.^{2,27,29} UV light sun exposure is the major etiologic factor. Increased risk also is associated with light skin color, a history of severe sunburns in childhood, overall nevus count greater than 50, light and red hair color, extensive freckling, and regular use of tanning beds. Men are more commonly affected, as are persons older than 50 years of age. Cytogenetic studies have implicated chromosomal regions 1p and 9p as possible locations for genetic alterations associated with predisposition to melanoma.²⁷⁻²⁹

Approximately 30% of melanomas arise from previously existing pigmented lesions, particularly ones with a history of trauma. Clinical features of melanoma are characterized by the mnemonic ABCDE—that is, asymmetry, irregular border, color variegation, diameter (>6 mm), and evolution.²⁹ The color usually is deep and may be brown, gray, blue, or jet black ([Fig. 26.12](#)). Multiple colors are a prominent sign. Bleeding, ulceration, firmness, and satellite lesions are characteristic of established lesions. Early diagnosis and complete resection are critical to long-term survival because cure rates approach 100% for persons with melanoma with a depth of 0.75 mm or less. By contrast, a depth of 1.6 mm or greater confers only a 20% to 30% 10-year survival rate. Vaccine therapies for melanoma are currently under clinical trial.²⁷⁻²⁹

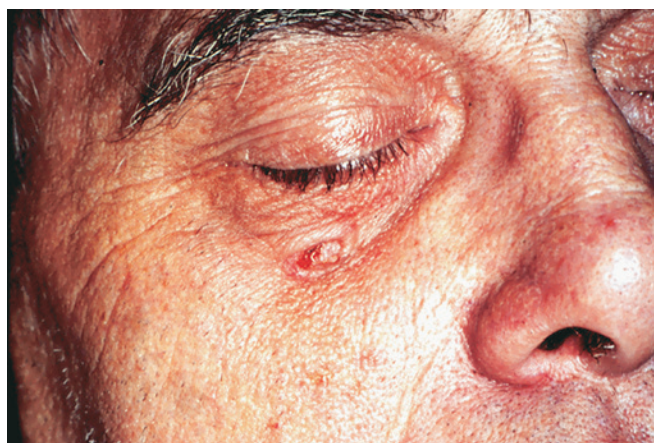

FIG 26.11 Basal cell carcinoma manifesting as a facial lesion in a dental patient.



FIG 26.12 Malignant melanoma of the chest. The arms, face, and neck are readily visible surfaces that can be examined by the dentist.

Prevention of skin cancer is achieved from the use of sun protection measures (sunscreens and clothing) and periodic screening.²⁷⁻²⁹ The ACS recommends self-examination once a month using a full-length mirror and a hand mirror to view the back and other hard-to-see areas of the body. Professional examination of the skin should be done every 3 years from 20 to 40 years of age, and after 40 years of age, it should be done every year.²⁷⁻²⁹ However, the USPSTF concluded that there is insufficient evidence to assess any benefit from these examinations.²⁹

Oral Cancer

Oral cancer includes a variety of malignant neoplasms that occur within the oral cavity (Box 26.4).³⁰⁻³³ More than 90% of cases are attributed to SCC. About 9% are carcinomas that arise from salivary gland tissues and other tissue types such as sarcomas and lymphomas. The remaining 1% or so are metastatic from elsewhere in the body, most commonly from the lung, breast, prostate, and kidney. In 2015, the ACS reported more than 45,000 cancers of the oral cavity and pharynx and almost 9000 deaths attributable to this disease in the United States.³¹⁻³³

Oral and pharyngeal cancer represents about 3% of all cancers in the United States.^{1-3,31-33} The vast majority of oral cancers occur in patients older than 45 years of age, and the incidence increases with each decade beyond age 40 years for men and women until age 65 years.^{1-3,31-33} Since 1985, little change has occurred in incidence and 5-year survival rates (see Table 26.1). The 5-year survival rates for all stages of oral cavity and pharyngeal cancer (63%) remain lower for African Americans (34%) than for whites (56%).^{1-3,31-33}

The biochemical factors in the pathogenesis of oral SCC have not been fully elucidated. At least 80% of cases are associated with the multiple cellular abnormalities

resulting from chronic and excessive exposure to carcinogens found in smoking tobacco, alcohol, smokeless tobacco, and, in Southeast Asian cultures, areca nut chewing in various preparations (e.g., paan [betel quid], gutka, and others).^{1-3,31-33} UV light exposure and immunodeficiency (e.g., HIV infection, solid organ transplantation) are associated with approximately 10% of cases. HPV infection (with high-risk types) can be detected in about 30% of cases, particularly those involving oropharyngeal subsites, such as the base of the tongue and palatine tonsils.^{14,15,32} Plummer-Vinson syndrome and a vitamin A deficiency also increase the risk for cancers of the oral cavity and oropharynx.³¹⁻³³ Other factors suggested to play a minor role in the cause of oral cancer include arsenic compounds used in the treatment of syphilis, nutritional deficiencies, heavy exposure to materials such as wood and metal dusts, and *Candida* infection.³¹⁻³³ Patients with Fanconi anemia are highly susceptible to oral SCC.³⁴

The cellular changes and contributory processes that result in SCC are shown in Fig. 26.3. At the subcellular level, chronic exposure of mucosal cells to carcinogens results in activation of oncogenes and gene mutations and deletions. The most common deletion in smoking tobacco-related oral SCCs (66% of SCCs of the aerodigestive tract) occurs in chromosome 9 (9p21-22). The most frequently detected mutation occurs in p53.^{5,31-34}

Overexpression of epidermal growth factor receptor (EGFR) and activation of the *ras* and *c-myc* oncogenes play contributory roles.^{5,31-33} HPV's involvement appears to be the result of its early gene (E6 and E7) products that increase the degradation of the p53 protein and protect cells from p53-induced apoptosis or tumor suppression.^{15,32} The result of these processes alters a normal cell into a dysplastic cell that eventually develops increased DNA content, functional independence, and loss of adherence. Eventually, these cells also promote angiogenesis.^{15,32} Oral SCC is variable in appearance. It may be a white or red patch, an exophytic mass, an ulceration, a granular raised lesion, or any combination of these (Figs. 26.13 and 26.14).³¹⁻³³ White lesions that cannot be scraped off and are clinically nonspecific, called *leukoplakia*, are potential precursor lesions. Approximately 19% of leukoplakias are dysplastic, and about 4% are considered SCC at initial biopsy.³⁰ Leukoplakias that are not cancerous when first biopsied have about a 6% to 10% chance of developing into cancer over time (Table 26.8).³⁰⁻³³ The malignant transformation rates for phenotypically heteromorphic (various morphologic characteristics—fissures, ulcerated, verrucous, and so on—within the same lesion) leukoplakias are higher (as high as 17.5%).³⁰⁻³³ Lesions with a histologic diagnosis of epithelial dysplasia have an even greater likelihood of becoming SCC (as high as 42% if dysplasia is severe).³¹⁻³⁴ Compared with homogeneous leukoplakias, leukoplakias with areas of erythema have a three- to fivefold greater chance of being cancerous at initial biopsy or developing into cancer.³⁰⁻³³ Nonspecific

BOX 26.4 Features of Some Common Cancers of the Oral Cavity, Head, and Neck

Basal cell carcinoma: Slightly raised lesion with rolled waxy border and central ulceration on sun-exposed surface

Squamous cell: Nonhealing white, red-white carcinoma lesion; ulcer; or fungating mass of the lateral tongue, floor of the mouth, lip

Kaposi sarcoma: Purple plaques or nodules of the palate, gingiva, or face

Melanoma: Brown or black enlarging plaque on skin or palate (satellite lesions)

Mucoepidermoid: Dome-shaped swelling with carcinoma central ulceration of palate, retromolar region, or lytic osseous lesion

Leukemia: Gingival enlargement, and bleeding, skin pallor, small hemorrhages of the skin and mucous membranes, and bruising

Lymphoma: Enlarged, nonpainful lymph nodes, palatal or pharyngeal swellings, retromolar ulcerations

Advanced breast, prostate, and renal cancer: Lytic osseous metastases in the mandible



FIG 26.13 A clinical cause for this tongue lesion could not be identified, and its appearance was not highly suggestive of cancer. Nevertheless, it was diagnosed as early squamous cell carcinoma by histopathologic analysis. In such cases, it would be appropriate for the dentist to request a biopsy of the lesion.



FIG 26.15 Tongue lesion with a high chance of being cancerous, as indicated by its clinical appearance (size, margins, induration). Direct referral of the patient to a cancer treatment center for diagnosis and therapy is indicated. This lesion was diagnosed as squamous cell carcinoma.

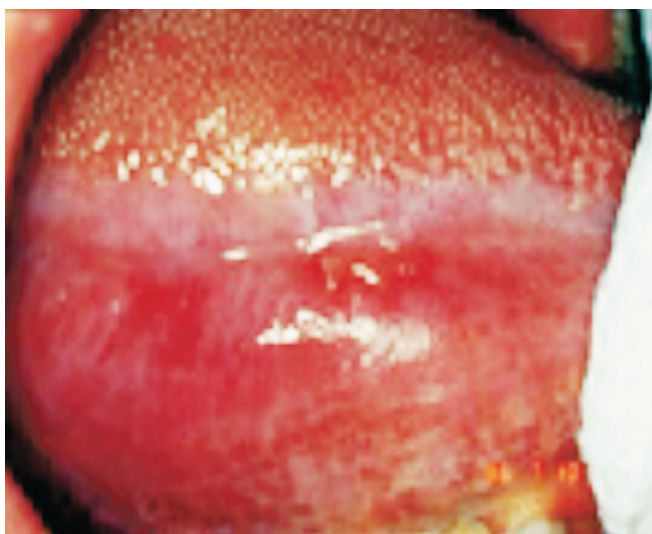

FIG 26.14 Squamous cell carcinoma appearing as erythroplakia (a red patch in a diffuse white lesion).



FIG 26.16 Squamous cell carcinoma appearing as an ulcerated lesion on the tongue with induration and raised margins.

TABLE 26.8 Color Characteristics of Oral Squamous Cell Carcinomas (SCCs)*

Color	% of Total SCCs
Only white lesions	24.8
White lesions with erythroplakia	60.0
Only erythroplakic (red) lesions	33.3
Other	1.9

*Data for 207 asymptomatic intraoral SCCs.

Adapted from Mashberg A, Samit A: Early diagnosis of asymptomatic oral and oropharyngeal squamous cancers, *CA Cancer J Clin* 45:328-345, 1995.

red lesions involving the oral mucosa (erythroplakia), although less common than white lesions (see [Table 26.8](#)), are malignant in more than 60% of cases at initial biopsy.³⁰⁻³³

A majority of early carcinomas are asymptomatic and have an erythroplastic component (see [Table 26.8](#)). Advanced lesions are more often ulcerated with raised margins and induration ([Fig. 26.15](#)). High-risk sites include the floor of the mouth, lateral (posterior) and ventral (anterior) surfaces of the tongue ([Fig. 26.16](#); see also [Fig. 26.15](#)), soft palate, and surrounding tissues.³⁰⁻³³ These areas are less keratinized and more susceptible to carcinogens. The buccal mucosa and gingivae also are common sites, especially in regions where social oral habits result in carcinogens being placed in close proximity to

these tissues. Carcinoma of the upper lip and dorsum of the tongue is rare.³⁰⁻³³

Oral SCC spreads by local infiltration into surrounding tissues or metastasis to regional lymph nodes through lymphatic channels.³⁰⁻³³ Spread to local structures results in induration, fixation, and lymphadenopathy. Routes of lymph node metastasis are through first-station drainage nodes (buccinator, jugulodigastric, submandibular, and submental) and then second-stage nodes (parotid, jugular, and the upper and lower posterior cervical nodes) (see Fig. 26.5).³⁰⁻³³ Distant metastasis is rare but occurs more commonly to the lung, liver, and bone. Lesions of the floor of the mouth, tongue, and posterior sites tend to metastasize earlier than carcinomas located in anterior oral sites such as the lip.³⁰⁻³³ Moreover, about 40% of patients with SCC of the tongue and floor of the mouth lack evidence of metastases at the time of treatment but develop metastatic disease later. Lesions in the maxillary region have a greater tendency to metastasize than do those in the mandibular region.³⁰⁻³³ Oral cancer can lead to death by (1) local obstruction of the pathway for food and air, (2) infiltration into major vessels of the head and neck (resulting in significant blood loss), (3) secondary infections, (4) impaired function of other organs through distant metastases, (5) general wasting, or (6) complications of therapy.³⁰⁻³³

In advanced cases of oral carcinoma, the patient may complain of weight loss and difficulty in breathing or nerve involvement that may cause local musculature to become atrophic or result in unilateral paralysis (e.g., loss of the gag reflex when soft palate involved).³⁰⁻³³ Other symptoms include hoarseness, dysphagia, intractable ulcers, bleeding, numbness, loosening of teeth, difficulty opening the mouth, and a change in the fit of a denture. The diagnosis of oral cancer is made using microscopic examination of tissue or cells taken from the lesion. Vital staining with toluidine blue can aid in identifying the location from which to biopsy.³⁰⁻³³ The international TNM system of classification and staging is used to evaluate and classify a tumor's status (see Box 26.1).³⁰⁻³³

Most early oral SCCs are amenable to surgery, but stage III or IV cancers (and those involving bone, vascular structures, and multiple lymph nodes) are usually treated with combination therapy (irradiation and surgery).^{32,35-37} Irradiation is by (1) interstitial; (2) implantation; or, more commonly, (3) external-beam methods, usually within 6 weeks of surgical resection. The tumoricidal dose of external-beam radiation ranges from 5000 to 7000 centigrays (cGy), given in separate doses of 150 to 200 cGy over a 6- to 7-week period, with 4 or 5 treatment days followed by 2 or 3 nontreatment days.^{32,35-37} Hyperfractionation uses slightly lower daily doses and is delivered twice a day. Neck dissection is performed to minimize the development of metastases after treatment of the primary tumor. A combination of radiotherapy and chemotherapy (cisplatin, 5-fluorouracil, or taxanes) is reserved for patients when the chance of cure is poor.

Selective intraarterial infusion of a chemotherapeutic agent (cisplatin) also has been used successfully in a select group of patients.^{32,35-37}

The overall 5-year survival rate (63%) for oral and pharyngeal SCC has been virtually unchanged since 1980.³²⁻³⁷ Higher survival rates are associated with early diagnosis, younger age, early cancers (stages I and II), anterior sites, cancer depth of 5 mm or less, and carcinomas that do not infiltrate bone. Recurrences are frequent, especially if patients fail to stop using tobacco and alcohol products.³²⁻³⁷

DENTAL MANAGEMENT

Dentists have an important role in the management of patient with cancers. A primary role is early recognition of the disease. Accordingly, dentists are advised to take a consistent approach for ascertaining pertinent medical, historical, and clinical information from the patient.³¹⁻³³ The dentist should question the patient carefully for signs and symptoms of cancer, particularly those in the head and neck region. Matters involving cancer can be approached by asking the patient questions such as, "Have you experienced any change in your health since your last visit?" or "Are you aware of a lump or bump developing under your arm or in your neck for no apparent reason; a lesion changing color; pain in any body region; or abnormal bleeding from any site, such as blood in the stool?" Such questions allow patients to recall events and situations pertinent to the pathogenesis of disease and may permit them to discuss the condition with the practitioner. Questions in the social history regarding overall health, exercise, diet, vitamin intake, tobacco and alcohol use, and cancer in family members also are important and permit a global assessment of the risk of cancer in the patient. The dentist also is in a prime position to discuss the benefits of cancer screening of organ systems (e.g., breast, colon, rectum, cervix, mouth, ovary, prostate, and skin) and its impact on survival (see Table 26.4). Certain medical centers and programs offer free cancer screening, and patients should be encouraged to take advantage of these services.³¹⁻³³

After the interview, clinical examination is mandatory to reveal clues of underlying cancer. A head and neck and intraoral soft tissue examination should be performed on each person. Any suspicious lesion should be biopsied or monitored very closely.³⁰⁻³³ It is important to remember that the early stages of cancer are often subtle and may be mistaken for common benign lesions, and the best prognosis occurs when the lesion is diagnosed when small and in the earliest stages.³⁰⁻³³ The dentist also should remember that the clinical features vary with the type of cancer and location. Lesions clinically suspicious for cancer and those that fail to heal within 14 days despite alleviating measures should be biopsied. In addition, patients with hard, fixed, or matted lymph nodes should be referred directly to a head and neck surgeon or a cancer treatment

center. It is critical to avoid any delay in diagnosis and management.³⁰⁻³³ See Table 26.9 for the National Comprehensive Cancer Program recommendations for head and neck cancer therapy.⁶ Each patient should be advised of the concern in a frank and open manner. Patients with other signs and symptoms suggestive of cancer should undergo workup with laboratory tests and imaging studies. Screening laboratory tests can be obtained by sending the patient to a hospital, a commercial clinical laboratory, or a physician.³⁰⁻³³ Blood tests should include a total red blood cell and white blood cell (WBC) count, a differential WBC count, a smear for cell morphologic study, hemoglobin, hematocrit count, and a platelet count. If the screening tests are ordered by the dentist and one or more result is abnormal, the patient should be referred for medical evaluation and treatment.³⁰⁻³³

Treatment Planning Modifications

Dental treatment planning for a patient with cancer begins with the establishment of the diagnosis. Planning involves (1) pretreatment evaluation and preparation of

the patient; (2) oral health care during cancer therapy, which includes hospital and outpatient care; and (3) post-treatment management of the patient, including long-term considerations. Cancers that are amenable to surgery and do not affect the oral cavity require few treatment plan modifications. However, certain cancers affect oral health either directly because of surgery or indirectly because of radiotherapy, chemotherapy, or immunosuppression.³⁵⁻³⁷ The focus of the remainder of this chapter is on treatments and complications that can affect the oral cavity.

Pretreatment Evaluation and Considerations

The dentist should be aware of the type of treatment selected for the patient and whether the treatment is with curative intent or palliative.³⁵⁻³⁷ See Table 26.9 for the National Comprehensive Cancer Program's recommendations for head and neck cancer therapy.^{6,35} A patient who is to receive palliative therapy may not want replacement of missing teeth; however, minimizing the propensity for the exacerbation of existing dental disease during cancer therapy is strongly advisable.³⁵ By contrast, a patient who

TABLE 26.9 National Comprehensive Cancer Network Guidelines for Treatment of Head and Neck Cancer*

Buccal mucosa, floor of mouth, anterior tongue, alveolar ridge, retromolar trigone, hard palate			
Clinical	Treatment of Primary and Neck	Adjuvant Treatment	Follow-Up
T1-2, N0	Resection of primary (preferred) ± ipsilateral (guided by tumor thickness) or bilateral (guided by location of primary) neck dissection ^f	No positive nodes and No adverse features ⁱ	Follow-up (See FOLL-A) ↓ Recurrent or Persistent Disease (See ADV-3)
	or Resection of primary ± sentinel lymph node (SLN) biopsy ^g	One positive node without adverse features ⁱ → Consider RT ^h	
or	SLN identification successful	Extracapsular spread ± positive margin → Systemic therapy/RT ^{h,j} (preferred) (category 1)	
	SLN identification unsuccessful → Neck dissection ^f	Adverse features ⁱ → Postive margin → Re-resection ^k or RT ^h or Consider systemic therapy/RT ^{h,j} (for T2 only)	
or	Definitive RT ^h	Other risk features → RT ^h or Consider systemic therapy/RT ^{h,j}	
	No residual disease → Follow-up (See FOLL-A)	Residual disease → Surgery	

^fSee Principles of Surgery (SURG-A).

^gSee Sentinel Lymph Node Biopsy in Principles of Surgery [SURG-A 6 of 9].

^hPrinciples of Radiation Therapy (OR-A).

ⁱAdverse risk features: extracapsular nodal spread, positive margins, pT3 or pT4 primary, N2 or N3 nodal disease, nodal disease in levels IV or V, perineural invasion, vascular embolism (lymphovascular invasion) (See Discussion).

^jSee Principles of Systemic Therapy (CHEM-A).

^kConsider re-resection to achieve negative margins, if feasible.

*More information can be found at National Comprehensive Cancer Network. https://www.nccn.org/professionals/physician_gls/pdf/head-and-neck.pdf.

has stage I or II cancer with no evidence of regional spread can be managed for future dental care as a normal patient. In such cases, however, more frequent recall appointments to examine the patient for evidence of metastases, recurrence of the lesion, or presence of a new cancer may be advisable.³⁵ Careful follow-up is particularly important in patients with oral cancer, who are at increased risk for a second primary cancer in the respiratory system, upper digestive tract, or oral cavity. The risk for a second oral cancer in smokers whose habits remained unchanged is about 30%, compared with 13% for those who quit.³¹⁻³⁴

A pretreatment oral evaluation is recommended for all cancer patients before the initiation of cancer therapy to (1) rule out oral disease that may exacerbate during cancer therapy, (2) provide a baseline for comparison and monitoring sequelae of radiation and chemotherapy damage, (3) detect metastatic lesions, and (4) minimize oral discomfort during cancer therapy. See [Box 26.5](#) for the guidelines for elective extraction of teeth before head and neck radiation or chemotherapy. [Box 26.6](#) illustrates the complications that may occur as a result of head and neck radiation or chemotherapy. [Box 26.7](#) illustrates the effects of head and neck radiation or chemotherapy. See [Box 26.8](#) for the Multinational Association of Supportive Care in Cancer/International Society of Oral Oncology (MASCC/ISOO) recommendations for the management of complications of head and neck cancer therapy.³⁸ The evaluation should include a thorough clinical and radiographic examination and review of findings on laboratory studies (complete blood count, differential WBC count, and so on). Edentulous regions should be surveyed to rule out impacted teeth, retained root tips, and latent osseous disease that could be exacerbated with immunosuppressive cancer therapy. A panoramic film is acceptable; however, supplemental bitewing and periapical films may be required for adequate visualization of dental and osseous structures.³⁵⁻³⁹

Pretreatment care should include oral hygiene instructions, the encouragement of a noncariogenic diet, calculus removal, prophylaxis and fluoride treatment, and elimination of all sources of irritation and infection.^{31-34,38} In children undergoing chemotherapy, mobile primary teeth and those expected to be lost during chemotherapy should be extracted, and gingival opercula should be evaluated for surgical removal to prevent entrapment of food debris. [Box 26.5](#) presents some guidelines for extracting questionable teeth before radiation therapy.

Of course, treatment with radiation results in a number of tissue complications ([Box 26.9](#)).³⁸⁻⁴⁸ Orthodontic bands should be removed before initiation of radiation or chemotherapy.

If head and neck radiation therapy and immunosuppressive chemotherapy are scheduled, the following recommendations should be considered.^{38,39}

- Reducing radiation exposure to noncancerous tissues (salivary glands) with lead-lined stents, beam-sparing

BOX 26.5 Guidelines for Tooth Extraction in Patients Scheduled to Receive Head and Neck Irradiation (Including the Mouth) or Chemotherapy

Indicators of Extraction

- Pocket depths ≥ 6 mm, excessive mobility, purulence on probing
- Presence of periapical inflammation
- Broken-down, nonrestorable, nonfunctional, or partially erupted tooth in a patient who is noncompliant with oral hygiene measures
- Patient lack of interest in saving tooth/teeth
- Inflammatory (e.g., pericoronitis), infectious, or malignant osseous disease associated with questionable tooth

Extraction Guidelines

- Extraction should be performed with minimal trauma, with timing as follows:
 - At least 2 weeks,* ideally 3 weeks, before initiation of radiation therapy
 - At least 5 days (in maxilla) before initiation of chemotherapy
 - At least 7 days (in mandible) before initiation of chemotherapy
- Trim bone at wound margins to eliminate sharp edges.
- Obtain primary closure.
- Avoid intraalveolar hemostatic packing agents, which can serve as a nidus for microbial growth.
- Transfuse if the platelet count is $<50,000/\text{mm}^3$.
- Delay extraction if the white blood count is $<2000/\mu\text{m}$ or the absolute neutrophil count is $<1000/\mu\text{m}$ or expected to be this level within 10 days; alternatively, prophylactic antibiotics (cephalosporin) can be used with extractions that are mandatory.

*In select circumstances in which healing will not be compromised, a minimum of 10 days is acceptable. Biologic modifiers that promote healing (e.g., vitamin C) may be useful in these circumstances. Alternatively, if these time recommendations cannot be met endodontic therapy may be initiated.^{7,48,49} Data from Rankin KB, Jones DL, Redding SW, editors: *Oral health care in cancer therapy: a guide for health care professionals*, ed 3, Dallas, Baylor Oral Health Foundation/Cancer Prevention & Research Institute of Texas, 2008.

procedures, or the management of salivary flow with the of anticholinergic (biperiden) or parasympathetic-mimetic (pilocarpine HCl and cevimeline HCl) drugs during and after radiotherapy should be discussed with the radiation oncologist and the patient.

- Nonrestorable teeth with poor or hopeless prognosis, acute infection, or severe periodontal disease that may predispose the patient to complications (e.g., sepsis, osteoradionecrosis) should be extracted; sharp, bony edges trimmed and smoothed; and primary closure obtained (see [Box 26.6](#)). Chronic inflammatory lesions in the jaws and potential sources of infection should be examined and treated or eradicated before radiation or chemotherapy.

BOX 26.6 Complications of Head and Neck Radiotherapy and Myelosuppressive Chemotherapy

- Nausea and vomiting—acute onset
- Mucositis—starts about second week
- Ulceration (C)
- Taste alteration—starts about second week
- Xerostomia (R)—starts about second week
- Secondary infections: fungal, bacterial, viral
- Bleeding (C)
- Radiation caries (R)—delayed onset
- Hypersensitive teeth—acute and delayed onset
- Muscular dysfunction (R)—delayed onset
- Osteoradionecrosis (R)—delayed onset (more common in mandible, less common in maxilla)
- Pulpal pain and necrosis—delayed onset (R): (orthovoltage-related; not found with cobalt-60)

C, Limited to or more prominent with chemotherapy; R, limited to or more prominent with radiotherapy.

From Rhodus NL: Pretreatment management of oral complications from chemotherapy and/or radiation therapy for head and neck cancer, *News from SPOHNC* 18(4):1-3, 2008.

BOX 26.7 Radiation Effect on Normal Tissues in the Path of the External Beam

Tissue	Effect
Mucosa and lamina propria	Epithelial changes (atrophy), mucositis, vascular changes, intimal thickening, luminal stenosis, obliteration, decreased blood flow
Muscle	Fibrosis, vascular changes
Bone	Decreased number of osteocytes, decreased numbers of osteoblasts, decreased blood flow
Salivary glands	Atrophy of acini, vascular changes, fibrosis
Pulp	Necrosis (orthovoltage)

Data from Rhodus NL: Management of oral complications from radiation and chemotherapy, *Northwest Dent* 89:39-42, 2010.

- Adequate time for wound healing before the induction of radiation therapy or myelosuppressive chemotherapy should be provided for extractions and surgical procedures (see [Boxes 26.6](#) and [26.10](#)).
- Symptomatic nonvital teeth should be endodontically treated at least 1 week before initiation of head and neck radiation or chemotherapy. However, dental treatment of asymptomatic teeth even with periapical involvement can be delayed.
- Prioritize treatment of infections, extractions, periodontal care, and irritations before treatment of carious teeth, root canal therapy, and replacement of faulty restorations. Temporary restorations can be placed and certain treatment (cosmetic, prosthodontic, endodontic) can be delayed when time is limited.

- Tooth scaling and prophylaxis should be provided before initiation of cancer therapy to optimize oral health and reduce the risk of oral complications such as mucositis and infection. Removable prosthodontic appliances should be removed during therapy.
- Patients who will be retaining their teeth and undergoing head and neck radiation therapy must be informed concerning the problems associated with decreased salivary function, which includes xerostomia and increased risk of oral infections, including radiation caries, and osteoradionecrosis (see [Box 26.10](#)).³⁸⁻⁴⁸

Dental preparation in a cancer patient who is going to be treated by surgery alone is not as critical as in a patient undergoing head and neck irradiation and chemotherapy. However, active oral infection should be treated, teeth that are broken down should be removed, and teeth that may be needed for retention of a prosthetic appliance can be restored as required. The better the dental health of the patient, the lower will be the risk of dental infection complicating the healing process. For all patients with oral cancer, the dentist should consider consultation with the maxillofacial prosthodontist so that proper coordination of the patient's dental and tooth replacement needs can be accomplished during the pre-surgical and postsurgical phases.³⁸⁻⁴⁸

Oral Care During Cancer Therapy

Radiation effects on oral tissue can be seen in [Box 26.7](#).³⁸⁻⁴⁸ Outpatient chemotherapy requires dental treatment to be provided at appropriate times between cycles.³⁵ Maintenance of oral health during cancer therapy is very important because oral complications develop in a significant proportion of patients who undergo cancer irradiation and chemotherapy (see [Box 26.10](#)).^{38,39} Patients whose treatment will include head and neck irradiation or inpatient chemotherapy should have oral infections and potential problems eliminated before initiation of cancer therapy, with routine dental care delayed until after cancer therapy is complete.^{38,39}

Management of Complications of Radiation Therapy and Chemotherapy

General management considerations with radiation therapy and chemotherapy are presented in [Boxes 26.9](#) and [26.10](#).^{38,39} Acute toxic reactions occur during and immediately after radiation therapy and chemotherapy. The severity of such toxicity is directly proportional to the amount of radiation or cytotoxic drug to which the tissues are exposed, and toxic effects are more evident in rapidly dividing cells. Delayed toxicity can occur several months to years after radiation therapy.³⁵⁻⁴⁰

Radiation therapy induces cell necrosis, microvascular damage, and parenchymal and stromal damage. The production of oxygen free radicals from ionizing radiation is one of the leading causes of cell damage. Cells that

BOX 26.8 Multinational Association of Supportive Care in Cancer Guidelines for Management of Mucositis

Recommendations in Favor of an Intervention (ie, strong evidence supports effectiveness in the treatment setting listed):

1. The panel *recommends* that 30 min of oral cryotherapy be used to *prevent* oral mucositis in patients receiving bolus 5-fluorouracil chemotherapy (II).
2. The panel *recommends* that recombinant human keratinocyte growth factor-1 (KGF-1/palifermin) be used to *prevent* oral mucositis (at a dose of 60 µg/kg per day for 3 days prior to conditioning treatment and for 3 days after transplant) in patients receiving high-dose chemotherapy and total body irradiation, followed by autologous stem cell transplantation, for a hematological malignancy (II).
3. The panel *recommends* that low-level laser therapy (wavelength at 650 nm, power of 40 mW, and each square centimeter treated with the required time to a tissue energy dose of 2 J/cm²), be used to *prevent* oral mucositis in patients receiving HSCT conditioned with high-dose chemotherapy, with or without total body irradiation (II).
4. The panel *recommends* that patient-controlled analgesia with morphine be used to *treat* pain due to oral mucositis in patients undergoing HSCT (II).
5. The panel *recommends* that benzydamine mouthwash be used to *prevent* oral mucositis in patients with head and neck cancer receiving moderate dose radiation therapy (up to 50 Gy), without concomitant chemotherapy (I).

Suggestions in Favor of an Intervention (ie, weaker evidence supports effectiveness in the treatment setting listed):

1. The panel *suggests* that oral care protocols be used to *prevent* oral mucositis in all age groups and across all cancer treatment modalities (III).
2. The panel *suggests* that oral cryotherapy be used to *prevent* oral mucositis in patients receiving high-dose melphalan, with or without total body irradiation, as conditioning for HSCT (III).
3. The panel *suggests* that low-level laser therapy (wavelength around 632.8 nm) be used to *prevent* oral mucositis in patients undergoing radiotherapy, without concomitant chemotherapy, for head and neck cancer (III).
4. The panel *suggests* that transdermal fentanyl may be effective to *treat* pain due to oral mucositis in patients receiving conventional or high-dose chemotherapy, with or without total body irradiation (III).
5. The panel *suggests* that 2% morphine mouthwash may be effective to *treat* pain due to oral mucositis in patients receiving chemoradiation for head and neck cancer (III).
6. The panel *suggests* that 0.5% doxepin mouthwash may be effective to *treat* pain due to oral mucositis (IV).
7. The panel *suggests* that systemic zinc supplements administered orally may be of benefit to *prevent* oral mucositis in oral cancer patients receiving radiation therapy or chemoradiation (III).

Recommendations against an Intervention (ie, strong evidence indicates lack of effectiveness in the treatment setting listed):

1. The panel *recommends* that PTA (polymyxin, tobramycin, amphotericin B) and BCoG (bacitracin, clotrimazole, gentamicin) antimicrobial lozenges and PTA paste *not* be used to *prevent* oral mucositis in patients receiving radiation therapy for head and neck cancer (II).
2. The panel *recommends* that iseganan antimicrobial mouthwash *not* be used to *prevent* oral mucositis in patients receiving high-dose chemotherapy, with or without total body irradiation, for HSCT (II), or in patients receiving radiation therapy or concomitant chemoradiation for head and neck cancer (II).
3. The panel *recommends* that sucralfate mouthwash *not* be used to *prevent* oral mucositis in patients receiving chemotherapy for cancer (I), or in patients receiving radiation therapy (I) or concomitant chemoradiation (II) for head and neck cancer.
4. The panel *recommends* that sucralfate mouthwash *not* be used to *treat* oral mucositis in patients receiving chemotherapy for cancer (I), or in patients receiving radiation therapy (II) for head and neck cancer.
5. The panel *recommends* that intravenous glutamine *not* be used to *prevent* oral mucositis in patients receiving high-dose chemotherapy, with or without total body irradiation, for HSCT (II).

Suggestions against an Intervention (ie, weaker evidence indicates lack of effectiveness in the treatment setting listed):

1. The panel *suggests* that chlorhexidine mouthwash *not* be used to *prevent* oral mucositis in patients receiving radiation therapy for head and neck cancer (III).
2. The panel *suggests* that granulocyte-macrophage-colony-stimulating factor mouthwash *not* be used to *prevent* oral mucositis in patients receiving high-dose chemotherapy, for autologous or allogeneic stem cell transplantation (II).
3. The panel *suggests* that misoprostol mouthwash *not* be used to *prevent* oral mucositis in patients receiving radiation therapy for head and neck cancer (III).
4. The panel *suggests* that systemic pentoxifylline, administered orally, *not* be used to *prevent* oral mucositis in patients undergoing bone marrow transplantation (III).
5. The panel *suggests* that systemic pilocarpine, administered orally, *not* be used to *prevent* oral mucositis in patients receiving radiation therapy for head and neck cancer (III), or in patients receiving high-dose chemotherapy, with or without total body irradiation, for HSCT (II).

Gy, Grays; HSCT, hematopoietic stem cell transplantation; mW, milliwatt; nm, nanometers.

*Level of evidence for each guideline is in parentheses after the guideline statement.

BOX 26.9 Management of Patients With Oral Complications of Radiotherapy and Chemotherapy

Complication	Recommended Management
Mucositis	Use guidelines from MASCC (Box 26.8).
Xerostomia*	Sugarless lemon drops, sorbitol-based chewing gum, buffered solution of glycerine and water, salivary substitutes
Radiation caries	Educate patient concerning the risks and motivate to maintain optimum oral hygiene. Custom trays for the daily application of fluoride constructed of soft flexible mouth guard material. Trays hold 5 to 10 drops of a 1% to 2% acidulated fluoride gel, applied 5 minutes each day. If the 1% to 2% acidulated gel is found to be irritating to the tissues, 0.5% neutral sodium fluoride gel can be substituted. Alternative: A single brush-on application of 5000 ppm fluoride (PrevDent) may be more effective for some patients. Frequent dental recall Patient compliance confirmed by monthly recall during first year Restoration for early carious lesions
Secondary infection	Culture, cytologic study, antibiotics, antifungal agents, antiviral agents
Sensitivity of teeth	Topical fluorides
Loss of taste	Zinc supplementation
Osteoradionecrosis	Prevention, caution with surgery, hyperbaric oxygen therapy
Muscular dysfunction	Use of tongue blades to help retain maximum opening of jaws and access to oral cavity

See Appendix B for medications, dosage, and duration of use.

MASCC, Multinational Association of Supportive Care in Cancer.

Adapted from Rhodus NL: Pretreatment management of oral complications from chemotherapy and/or radiation therapy for head and neck cancer, *News from SPOHNC* 18(4):1-3, 2008.

*Salivary gland dysfunction, hyposalivation, or xerostomia should be managed by the diagnosis and according to the signs, symptoms, and severity of its manifestations in the oral cavity. Decreases in the quantity and alterations in the composition of beneficial constituents of saliva render the patient susceptible to many problems. The strategies for management will vary from patient to patient according to severity.

BOX 26.10 Recommendations for Invasive Oral Procedures in Cancer Patients Undergoing Chemotherapy in an Outpatient Setting

Provide routine care when:

- The patient feels best—generally 17 to 20 days after chemotherapy session
- Granulocyte count is >2000 cells/ μm
- Platelet count is $>50,000$ cells/ μm
- Consultation with physician is recommended when values are lower than range
- Platelet count $<50,000/\mu\text{m}$ may be associated with significant bleeding (see Chapter 24)

undergo rapid turnover are more susceptible to such damage. For this reason, hypoxic cells and slowly replicative cells are more resistant to radiation than are those that are well oxygenated and mitotically active. Box 26.7 lists the effects of radiotherapy on different oral tissues. Box 26.10 lists the recommendations for performing invasive dental treatment on these patients.^{38,39}

Most chemotherapeutic agents cause alopecia, breakdown of the mucous membranes (mucositis), depression of the bone marrow (infection, bleeding, anemia), gastrointestinal changes (diarrhea, malabsorption), and altered nutritional status, and such agents also can induce

cardiac and pulmonary dysfunctions. Bone marrow suppression and mucositis associated with chemotherapy are predictable, dose dependent, and usually manageable. Patients receiving chemotherapy may manifest erythema and ulceration of the oral mucosa, infection of the surrounding tissues, excessive bleeding with minor trauma, xerostomia, anemia, and neurotoxicity.^{35,36}

Mucositis. Mucositis, inflammation of the oral mucosa, results from the direct cytotoxic effects of radiation or antineoplastic agents on rapidly dividing oral epithelium and from the upregulation of proinflammatory cytokine expression (see Appendix C).^{38,39} Mucositis occurs in up to 40% of patients undergoing chemotherapy and often is a dose-limiting factor for chemotherapy and a cause of dose interruption of radiation therapy. It develops more often in nonkeratinized mucosa (buccal and labial mucosa, ventral tongue) and adjacent to metallic restorations by the end of the second week of radiation therapy (if the dose is 200 cGy per week). Mucositis develops most often between days 7 and 14 after chemotherapy (especially VP16, etoposide, and methotrexate), when the effects of the drugs produce an extremely low WBC count (nadir). It generally subsides 1 to 2 weeks after the completion of treatment (Fig. 26.17). Young cancer patients with higher cell division rates exhibit a greater prevalence of chemotherapy-induced mucositis than do older cancer patients.^{38,39}

Mucositis produces red, atrophic, and tender oral mucosa with epithelial sloughing similar to a severe oral

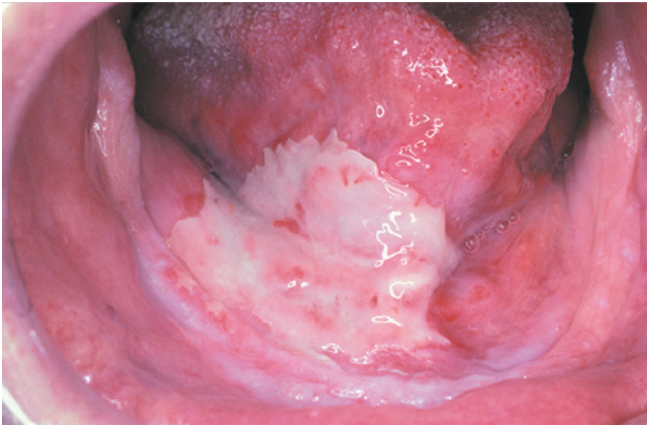

FIG 26.17 Extensive mucositis that developed from the effects of radiation on the oral mucosa. (From Neville BW, et al: *Oral and maxillofacial pathology*, ed 3, St. Louis, 2009, Saunders.)

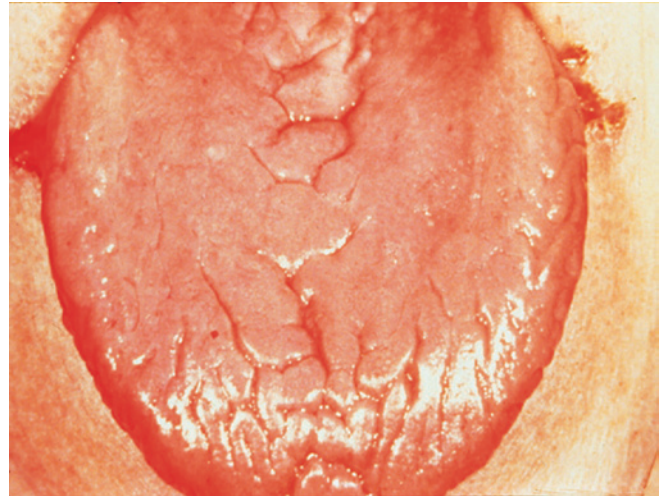

FIG 26.18 Severe xerostomia that developed from the effects of radiation on the oral mucosa. Note the angular cheilitis.

burn. Oral ulcerations can result from breakdown of the epithelial barrier and infection by viral, bacterial, or fungal organisms.^{38,39} Patients typically complain of ulceration, pain, dysphagia, loss of taste, and difficulty in eating, and the risk for oral and systemic infection is increased. If the major salivary glands have been irradiated, xerostomia (Fig. 26.18) comes after the initial onset of mucositis. The complications of mucositis and xerostomia make the patient extremely uncomfortable, increasing the difficulty of maintaining proper nutritional intake.^{38,39}

During this acute phase, the goal is to maintain mucosal integrity and oral hygiene. Oral mucositis can be reduced by using oral cryotherapy, human recombinant keratinocyte growth factor (KGF-1 or palifermin), low-level laser therapy, systemic analgesics, and supplemental zinc.³⁸ Mucositis also may be managed with use of (1) a bland mouth rinse (salt and soda water) to keep ulcerated areas as clean as possible; (2) topical anesthetics (viscous lidocaine 0.5%) and/or an antihistamine solution (benzylamine HCl [Tantum rinse], diphenhydramine [Benadryl], promethazine [Phenergan]) to provide pain control or, when combined with milk of magnesia, Kaopectate, or sucralfate, to serve as a coating agent (for protection of the ulcerated areas); (3) antimicrobial rinses such as chlorhexidine; (4) antiinflammatory agents (e.g., Kamisolan Liquidum or topical steroids [dexamethasone]); (5) adequate hydration; (6) a diet consisting of soft foods, protein, and vitamin supplementation at therapeutic levels; (7) oral lubricants and lip balms with a water base, beeswax base, or vegetable oil base (e.g., Surgi-Lube); (8) humidified air (humidifiers or vaporizers); and (9) avoidance of alcohol, tobacco, and irritating foods (e.g., citrus fruits and juices and hot, spicy dishes)³³ (see Box 26.9 and Appendix C). Dentures should not be worn until the acute phase of mucositis resolves. Dentures should be cleaned and soaked in an antimicrobial solution daily to prevent infections.^{38,39} See Boxes 26.9 and 26.10.

Secondary Infections. During radiation therapy and chemotherapy, patients are prone to secondary infections. Because of the quantitative decrease in actual salivary flow and compositional alterations in saliva, various microbial organisms (bacterial, fungal, and viral) can cause opportunistic infections of the oral cavity. Moreover, if the patient is immunosuppressed from chemotherapy and the WBC falls below 2000 cells/ μm^3 , the immune system is less able to manage such infections. Opportunistic infections also are common in patients who receive chemotherapy and broad-spectrum antibiotics.^{38,39}

The organism most frequently implicated in opportunistic infections of the oral cavity in patients undergoing cancer therapy (in whom hyposalivation and immunosuppression are common) is *Candida albicans*. Cytologic study, potassium hydroxide (KOH) staining, microscopic examination, and *Candida*-specific cultures are often performed to provide a definitive diagnosis. Candidal infections can produce pain, burning, taste alterations, and intolerance to certain foods, especially acidic citrus fruits or spicy foods. They manifest clinically in four different forms ranging from denuded epithelium to hyperplastic lesions. During cancer therapy, the most common type is *pseudomembranous* candidiasis, which produces white plaques that are easily scraped off, leaving behind tiny petechial hemorrhages (Fig. 26.19). Slightly less prevalent is the *erythematous*, atrophic form, which manifests as a red patch accompanied by a burning sensation (see Appendix C). The other forms of candidiasis—*angular cheilosis* and the less common *hypertrophic* form, which manifests as a thick, white plaque that cannot be scraped off—are more commonly detected in patients with chronic hyposalivation.^{38,39}

Candidiasis is best managed with topical oral antifungal agents. These include nystatin (oral suspension 100,000 international units [IU]/mL four to five times daily), clotrimazole (Mycelex lozenges 10 mg five times a day),



FIG 26.19 Oral candidiasis (pseudomembranous form) in a patient undergoing chemotherapy. Arrow indicates lesions of pseudomembranous candidiasis. (From Allen CM, Blozis GG: Oral mucosal lesions. In Cummings CW, et al, editors: *Otolaryngology: head and neck surgery*, ed 3, St. Louis, 1998, Mosby.)

and other preparations such as vaginal topical antifungal agents.^{38,39} Prophylactic use of antifungal agents may be required in patients undergoing chemotherapy who have frequent recurrent infections. Ketoconazole (Nizoral), fluconazole (Diflucan), or itraconazole (Sporanox) may be used if systemic therapy is warranted or if patients develop unusual oral fungal infections (torulopsis, aspergillosis, mucormycosis) or fungal septicemia (possibly from the oral cavity) (Box 26.11; see also Appendix C).^{38,39}

Bacteria and viruses may be the cause of other secondary infections. Oral bacterial infections may appear with typical signs of swelling, erythema, and fever. Alternatively, these features can be masked in patients with low WBC counts caused by chemotherapy. In immunosuppressed patients, a shift occurs in the oral flora to gram-negative organisms that normally inhabit the gastrointestinal or respiratory tract such as *Pseudomonas*, *Klebsiella*, *Proteus*, *Escherichia coli*, or *Enterobacter* spp. The most common presentation is an oral ulceration. Dentists should therefore culture all nonhealing oral ulcerations in such patients,

BOX 26.11 Management of Salivary Dysfunction

1. Moisture–Lubrication

General

- Drink or sip water, liquids (that lack fermentable carbohydrate and carbonic acid).
- Avoid ethanol, tobacco, coffee, tea, and hot spicy foods.
- Use sugarless candy or gum (Spry gum).

Products (Over-the-Counter [OTC] and Prescription)

- Artificial salivas: Glandosane spray, Moi-Stir, MouthKote, Optimoist, Roxane saliva substitute, Salivart spray, Salix lozenges or generic (sodium carboxymethylcellulose 0.5% aqueous solution)
- **OTC** Oral Balance: apply $\frac{1}{2}$ tsp five or six times daily
- **Rx** Pilocarpine HCl 2% (Salagen)[†] 5 mg, three or four times daily
- **Rx** Anethole trithione (Sialor)[†] 25 mg three times a day
- **Rx** Bethanechol chloride (Urecholine)[†] 25 mg three times a day
- **Rx** Cevimeline (Evoxac)[†] 30-mg caps three times a day

2. Soft Tissue Lesions–Soreness General (code as in Moisture-Lubrication)

- To provide relief from pain and inflammation

OTC

- Oral Balance
- Biotene

Rx

- “Magic Mouthwash”: diphenhydramine (Benadryl) + Maalox + nystatin elixir[‡] (\pm sucralfate) (\pm 0.5% viscous lidocaine) (\pm guaifenesin)
- Dexamethasone (Decadron Elixir) 0.5 mg/5 mL[§]
- Triamcinolone 0.1% (in hydrocortisone acetate [Orabase HCA])
- Clotrimazole (Mycelex) 60-mg troches
- Nystatin plus triamcinolone ointment (Mycolog II, Tristatin II, Mytrex)

3. Prevention of Caries–Periodontal Disease

- Meticulous personal oral hygiene
- Avoidance of acidic drinks
- Fluoridated toothpaste (Biotene)
- Regular hygiene recalls and dental prophylaxis (at 3-month intervals)
- Mechanical brushes, Waterpik, NaHCO₃ rinses
- Fluoride varnishes
- Rx** Neutral sodium fluoride (NaF) 1.0%—trays (Prevident 5000)
- Rx** Chlorhexidine gluconate (Peridex, Periguard—alcohol free)

*Salivary gland dysfunction, hyposalivation, or xerostomia should be managed by the diagnosis and according to the signs, symptoms, and severity of its manifestations in the oral cavity. Decreases in the quantity and alterations in the composition of beneficial constituents of saliva render the patient susceptible to many problems. The strategies for management will vary from patient to patient according to severity and are divided into three major areas, as listed.

[†]Caution is indicated with use in patients who have chronic obstructive pulmonary disease and patients at risk for myocardial infarction.

[‡]Rx: Benadryl 25 mg/10 mL, nystatin 100,000 IU/mL, Maalox 4 mL, to equal 15 mL.

[§]Rx: Decadron Elixir 0.5%/5 mL. Disp: 100 mL. Sig: 1 tsp. tid swish-swallow.

Adapted from Rhodus NL: Post treatment management of oral complications from chemotherapy and/or radiation therapy for head and neck cancer, *News from SPOHNC* 18(4):1-3, 2008.



FIG 26.20 Recurrent herpes simplex virus infection manifesting as a large ulcer on the palate of a patient undergoing chemotherapy.

and these specimens should be sent for diagnosis and antibiotic sensitivity testing. If a bacterial infection is suspected, appropriate antibacterial therapy should be initiated. Antimicrobial sensitivity data are important for the selection of an effective antibiotic when little or no clinical improvement occurs after several days.^{38,39}

Recurrent herpes simplex virus eruptions often develop during chemotherapy if antivirals are not prophylactically prescribed.^{39,40} They are infrequent during radiation therapy. HSV recurrences in patients with cancer undergoing chemotherapy tend to be larger and take longer to heal than herpetic lesions found in nonimmunocompromised patients (Fig. 26.20). Antiviral agents (acyclovir, famciclovir, or valacyclovir) are recommended prophylactically for HSV antibody-seropositive patients who are undergoing chemotherapy to prevent recurrences. A daily dose of at least 1 g acyclovir equivalent is needed to suppress HSV recurrences.⁴⁰ Because these ulcers can mimic the appearance of aphthous ulcerations and can occur on nonkeratinized mucosa in immunocompromised cancer patients, obtaining a culture or use of an enzyme-linked immunoassay is important for accurate diagnosis.^{38,39} Laboratory tests also help distinguish the infection from other oral herpesvirus infections, such as varicella zoster and cytomegalovirus infections, that can occur in these patients. Antiviral sensitivity testing should be considered for patients with unresolving or extensive infections and those in poor general health.^{38,39}

Bleeding. Cancer patients who undergo total body irradiation or high-dose chemotherapy or have bone marrow involvement because of disease also are susceptible to thrombocytopenia. Gingival bleeding and submucosal hemorrhage can occur as a result of minor trauma (e.g., tongue biting or toothbrushing) when the platelet count drops below 50,000 cells/mm³.^{35,39} Palatal petechiae, purpura on the lateral margin of the tongue, and gingival bleeding or oozing are common features. Gingival hemorrhage is aggravated by poor oral hygiene. When gingival tissues

bleed easily and the platelet count is severely reduced, the patient should avoid vigorous brushing of the teeth and begin using softer devices such as Toothettes or gauze wrapped around a finger and dampened in warm water or an antimicrobial solution (chlorhexidine in water, prepared by the pharmacist). During this stage, patients should be instructed not to use toothpicks, water-irrigating appliances, or dental floss. To control gingival bleeding, local measures, such as application of pressure with a gelatin sponge with thrombin or microfibrillar collagen placed over the area or use of an oral antifibrinolytic rinse (aminocaproic acid [Amicar] syrup 250 mg/mL) placed in a soft vinyl mouthguard can be used to control bleeding. If local measures fail, medical help should be obtained and platelet transfusion considered (see Chapter 24).

Neural and Chemosensory Changes. Many patients receiving radiation therapy experience a diminished sense of taste, probably as a result of damage to the microvilli of the taste cells. Patients receiving chemotherapeutic agents typically complain of a bitter taste in the mouth, unpleasant odors, and aversions to certain foods. To minimize sensory stimulation, the dentist should avoid use of scented body care products, including cologne, before contact with patients undergoing radiation therapy or chemotherapy. In most patients, the ability to taste returns in 3 to 4 months after completion of radiotherapy.

Neurotoxicity is a side effect of chemotherapeutic agents, particularly vincristine and vinblastine.^{7,35,36,39} Although this complication more commonly arises in the peripheral nerves, patients treated with these agents can experience odontogenic pain that mimics irreversible pulpitis. The pain is more frequently described in the molar region and can be bilateral. Proper diagnosis requires the clinician to be familiar with the chemotherapy drug regimen and is aided by the absence of clinical or radiographic abnormalities.

Other Considerations in Dental Management

Many patients with cancer have indwelling catheters (Hickman catheters or ports) that are susceptible to infection.⁴¹ The CDC does not recommend antibiotic prophylaxis for these patients before invasive dental procedures.⁴¹ Likewise, patients with prosthetic implants (breast, penile, oral) that have been placed to restore esthetics or function after resection of cancerous tissue or cancer treatment are not considered to be at risk for bacterial seeding from oral invasive procedures and do not require antibiotic coverage.⁴¹

Patients who are neutropenic should not undergo invasive dental procedures without special preparation and precautions. The patient's physician may select to use recombinant human granulocyte-stimulating factor to promote growth and differentiation of neutrophils before surgical procedures.^{35,36,39}

Whether a patient is receiving inpatient or outpatient chemotherapy, the dentist should be familiar with the

patient's WBC count and platelet status before dental care. In general, routine dental procedures can be performed if the granulocyte count is greater than 2000/mm³, the platelet count is greater than 50,000/ μ m, and the patient feels capable of withstanding dental care (see Chapter 25). For outpatient care, this is generally after chemotherapy or a few days before the next chemotherapy cycle (see Box 26.10).^{35,36,39} If urgent care is needed and the platelet count is below 50,000/mm³, consultation with the patient's oncologist is required. Platelet replacement may be indicated if invasive or traumatic dental procedures are to be performed, and topical therapy using pressure, thrombin, microfibrillar collagen, and splints may be required (see Chapter 24).³⁹

If urgent dental care is needed and the granulocyte count is less than 2000 cells/mm³, consultation with the physician is recommended, and antibiotic prophylaxis may be provided (see Box 26.10). The use of prophylactic antibiotics for these patients is without scientific evidence of effectiveness.⁴¹ No standard antibiotic regimen is recommended for prophylaxis. If prophylactic antibiotics are used, the drug(s), duration, and dosage to be used for prophylaxis should be established in consultation with the patient's oncologist.

Post-Cancer Treatment Management

After cancer therapy, consultation with the physician is recommended to determine whether the patient is cured or in remission or is completing palliative care. If cancer therapy is completed and remission or a cure is the outcome, the cancer patient should be placed on an oral recall program. Usually, the patient is seen once every 1 to 3 months during the first 2 years and at least every 3 to 6 months thereafter.^{35,36,39} After 5 years, the patient should be examined at least once per year. This recall program is important for the following reasons: (1) a patient with cancer tends to develop additional lesions, (2) latent metastases may develop, (3) the initial lesions may recur, and (4) complications related to therapy can be detected and managed. The usual long-term complications associated with the cancer and its therapy include chronic xerostomia, loss of taste, altered bone, and related problems.^{35,36,39} Recall appointments also are important to ensure that the dentate patient continues to maintain good oral hygiene (including daily brushing, flossing, and fluoride gel applications) and to promote early detection of oral soft tissue and hard tissue disease before inflammation and infection involves the underlying bone leading to necrosis. Patients who have completed palliative care should be afforded any preventive oral care and dental procedures they desire and can withstand.³⁹

Hyposalivation and Its Sequelae. Salivary gland tissue is moderately sensitive to radiation damage.⁴²⁻⁴⁴ Because of this, acinar tissue that is in the field of radiation can be permanently damaged during head and neck radiation therapy, resulting in hyposalivation.⁴²⁻⁴⁴ The degree of hyposalivation is directly related to the radiation field

and dose (i.e., the dose delivered to the major salivary glands) and to baseline salivary function.⁴²⁻⁴⁴ Doses in excess of 3000 cGy are the most damaging, especially if shielding or medication is not provided to the patient during delivery of radiation. Irradiated salivary glands become dysfunctional as a consequence of acinar atrophy, vascular alterations, chronic inflammation, and loss of salivary parenchymal tissue. Usually, a 50% to 60% reduction in salivary flow occurs in the first week after radiation therapy. As a sequela of radiotherapy, saliva is reduced in volume and altered in consistency, pH, and immunoglobulin concentration. The consistency is mucinous, thick, sticky, and ropy because the serous acini are more sensitive to radiation than mucous acini. Unfortunately, the pathologic changes often progress over several months after radiotherapy has ceased, and the radiation-induced salivary gland damage and dysfunction may be permanent. In most cases, no recovery of salivary gland function occurs.⁴²⁻⁴⁴

The direct effects of hyposalivation include extreme dryness of the oral mucosa (see Fig. 26.18). Of major significance are the discomfort, inconvenience, and substantial diminution of quality of life that accompanies oral dryness. Clearly, saliva is an important host defense mechanism against oral disease, serving a variety of important functions in the oral cavity. In a healthy mouth, copious saliva containing essential electrolytes, glycoproteins, immunoglobulins, hydrolytic enzymes (amylase), antimicrobial enzymes, and a number of other important factors that continually lubricate and protect the oral mucosa.⁴²⁻⁴⁴ Saliva in normal quantities and composition serves to cleanse the mouth, clear potentially toxic substances, regulate acidity, buffer decalcifying acids, neutralize bacterial toxins and enzymes, destroy microorganisms, and remineralize enamel with inorganic elements (e.g., calcium and phosphorus), thereby maintaining the integrity of the teeth and soft tissues.⁴²⁻⁴⁴

When the normal environment of the oral cavity is altered because of a decrease in or total absence of salivary flow or as a consequence of alterations in salivary composition, a healthy mouth becomes susceptible to painful deterioration and decay.⁴²⁻⁴⁶ Dry, atrophic, and fissured oral mucosa and soft tissues are the usual consequences of hyposalivation, along with accompanying ulcers and desquamation, opportunistic bacterial and fungal infections, inflamed and edematous tongue, caries, and periodontal disease. Extreme difficulty in lubricating and masticating food (sticking to the tongue or hard palate) and difficulty swallowing food (dysphagia)⁴²⁻⁴⁶ are common and among the most devastating clinical consequences of hyposalivation, with the potential for profound systemic changes affecting the overall health of the patient. Additionally, lack of or altered taste perception (hypogeusia or dysgeusia) and altered tolerance for certain acidic foods (e.g., citrus fruits, acetic acid, vinegar) occur in the absence of adequate saliva. As a result, nutritional intake may be impaired.⁴⁵



FIG 26.21 Note the extensive cervical caries in a patient who received radiotherapy. (Courtesy of R. Gorlin, Minneapolis, MN.)

The manifestations of salivary hypofunction in patients having undergone radiation therapy for head and neck cancer include severe salivary hypofunction (unstimulated salivary flow <0.2 mL/min), mucositis, cheilitis, glossitis, fissured tongue, glossodynia, dysgeusia, dysphagia, and a severe form of caries called *radiation caries* (Fig. 26.21).^{39,45} The incidence of such severe caries is estimated to be 100 times higher in patients who have received head and neck radiation than in normal, healthy persons.^{39,45} Radiation caries can progress within months, advancing toward pulpal tissues and resulting in periapical infection that extends to involve the surrounding irradiated bone; extensive infection and necrosis can result. A prescription for concentrated fluoride toothpaste (5000 ppm) should be provided to these patients for use in custom trays or brush-on application (see Box 26.11), and an assessment of salivary flow should be made.⁴²⁻⁴⁴

Salivary gland-sparing strategies, such as intensity-modulated radiation therapy (IMRT), help to reduce the damage to salivary glands during radiotherapy. Additionally, amifostine (Ethyol) may be infused during radiotherapy sessions to minimize radiation damage. However, damage to salivary glands still occurs and some hyposalivation will result.⁴²⁻⁴⁶ After a proper diagnostic assessment that determines the level of unstimulated and stimulated salivary flow, xerostomia is managed according to the three categories delineated in Box 26.11. First is the provision of additional moisture and lubrication to the oral cavity and oropharynx. This may be accomplished by either simulation of oral fluids or stimulation of endogenous saliva.^{43,44} Several artificial salivas are available, some of which provide a modicum of symptomatic relief from oral dryness. However, synthetic saliva solutions alone do not appear to be satisfactory for relief of the complaints associated with chronic xerostomia. Generally, they are compounded from carboxymethylcellulose or hydroxymethylcellulose. Some contain fluoride and supersaturated calcium and phosphate ions.³⁹ Patients should be encouraged to drink

plenty of water and other fluids with the exception of diuretics such as coffee or tea. Ethanol and tobacco should be avoided or minimized because they dry the oral mucosa. Also, patients who have undergone irradiation for cancer treatment may sip drinks constantly to keep the oral mucosa moist; such drinks should not be products containing a fermentable carbohydrate or carbonic acid, which may cause exposed cementum and dentin to break down rapidly (in <6 months), resulting in radiation caries. Sucking on sugarless mints or hard candies and chewing gum are beneficial in producing some additional moisture.^{39,45}

Of substantial benefit are secretagogue drugs such as pilocarpine HCl (Salagen); anethole trithione (Sialor); and recently, cevimeline (Evovac). Pilocarpine is the prototype parasympathomimetic drug derived from the pilocarpus plant. It is an alkaloid, muscarinic-cholinergic agonist and is known to stimulate smooth muscle and exocrine secretions. Pilocarpine has been extensively tested in safety and efficacy trials and has proven to be very effective in postirradiation therapy-induced xerostomia.⁴²⁻⁴⁴ These parasympathomimetic drugs appear to be effective for stimulating salivary flow in most patients who have some residual salivary acinar function. However, certain side effects occur, and patients must be carefully screened (i.e., for cardiovascular disease, diabetes, and concomitant medications) before being prescribed these drugs. Of particular note is that approximately half of the patients who used pilocarpine and experienced increased salivary flow noticed symptomatic improvement in their dry mouth. Therefore, although the drug increases salivary flow and provides endogenous beneficial constituents to the oral cavity, patients may still need adjunctive artificial salivas to feel more comfortable.⁴²⁻⁴⁴

Fungal Infection. Opportunistic infection with *C. albicans* is very prevalent among patients who have undergone radiation therapy, with more than 80% of such patients exhibiting infection with the fungus if proper diagnostic testing is used (see earlier under “Secondary Infections” and Appendix C).³⁹

Tooth Sensitivity. During and after radiotherapy, the teeth may become hypersensitive, which could be related to the decreased secretion of saliva and the lowered pH of secreted saliva. The topical application of a fluoride gel, dentinal tubule-blocking agents including fluoride solution, oxalate-containing resin and resin-based desensitizers, and yttrium-aluminum-garnet (YAG) laser treatment may be of benefit in reducing these symptoms.⁴⁷

Muscle Trismus. Radiation therapy of the head and neck can cause damage to the vasculature of muscles (obliterative endoarteritis) and consequent trismus of the masticatory muscles and joint capsule. To minimize the effects of radiation on the muscles around the face and the muscles of mastication, a mouth block should be placed when the patient is receiving external-beam irradiation.^{38,39} The patient also should perform daily stretching exercises to relieve trismus and apply local warm moist

heat. One exercise is for the patient to place a given number of tongue blades in the mouth at least three times a day for 10-minute intervals. By slowly increasing the number of tongue blades, muscle stretching will occur, and more normal function will ensue.

Prostodontics. Patients should avoid wearing their dentures during the first 6 months after completion of the radiotherapy because even mild trauma to the altered mucosa can result in ulcerations and possible necrosis of underlying bone (see “Osteoradionecrosis,” next).^{39,48,49} When patients start to wear their dentures, they must be instructed to return to the dentist if any sore spots develop, so that the dentures can be adjusted. Ill-fitting dentures should be replaced by new ones. In severe cases of chronic xerostomia, a small amount of petrolatum can be applied to the mucosal surface of the denture to help with adhesion. Implants can be placed 12 to 18 months after radiation therapy, but the procedure requires knowledge of tissue irradiation fields, degree of healing, and vascularity of the region.^{39,48,49} For example, implants placed in the maxilla and the anterior mandible are associated with less of a risk for osteoradionecrosis than are those placed in the posterior mandible.

Osteoradionecrosis. Osteoradionecrosis is a condition characterized by exposed bone that fails to heal (present for 6 months) after high-dose radiation to the jaws (Fig. 26.22).^{39,48,49} Osteoradionecrosis results from radiation-induced changes (hypocellularity, hypovascularity, and ischemia) in the jaws. Most cases result from damage to tissues overlying the bone as opposed to direct damage to the bone.^{39,48,49} Accordingly, soft tissue necrosis usually precedes involvement of bone and is variably present at the time of diagnosis. Risk for development of this complication is greatest in posterior mandibular sites and in patients who have received radiation doses in excess of 6500 cGy to the jaw, those who continue to smoke,



FIG 26.22 Osteoradionecrosis. Exposed necrotic bone is evident in the posterior mandible edentulous ridge of a patient who previously received radiation therapy to the head and neck region.

and those who have undergone a traumatic (e.g., extraction) procedure. Risk is greater for dentate patients than for edentulous patients and for those with periodontal disease. Nonsurgical procedures associated with tissue trauma (e.g., curettage) or with reduction in blood supply to the region (e.g., use of vasoconstrictors) can result in osteoradionecrosis. Spontaneous osteoradionecrosis also occurs. The risk remains throughout the patient's lifetime.^{48,49}

If the dentist is unsure of the amount of radiation received and invasive procedures are planned, the radiation oncologist should be contacted to determine the total dose to the head and neck region before dental care is initiated (Box 26.12).^{39,48,49} Clinicians should be aware that risk of osteoradionecrosis increases with increasing dose to the jaws (e.g., 7500 cGy is associated with greater risk than 6500 cGy). Patients determined to be at risk should be provided with the appropriate preventive

BOX 26.12 Recommendations to Prevent Osteoradionecrosis in the Patient Undergoing Irradiation of the Head and Neck

1. Extract teeth with questionable and hopeless prognosis at least 2 weeks before radiotherapy.
2. Avoid extractions during radiotherapy.
 - Mandible is at greater risk than maxilla.
 - Posterior sites are at greater risk than anterior sites.
3. Minimize infection:
 - Prophylactic antibiotic use: Give 2 g penicillin VK orally 1 hour before surgical procedure.
 - After surgery: Continue with penicillin VK 500 mg four times a day for 1 week.
4. Minimize hypovascularity after radiotherapy:
 - Use nonlidocaine local anesthetic (e.g., prilocaine plain or forte) for dental procedures.
 - Minimize or avoid use of vasoconstrictor; if necessary, consider low-concentration epinephrine ($\leq 1:200,000$).
 - Consider hyperbaric oxygen therapy.*
5. Minimize trauma:
 - Endodontic therapy is preferred over extraction (if the tooth is at all restorable).
 - Atraumatic surgical technique is essential.
 - Avoid periosteal elevations.
 - Limit extractions to two teeth per quadrant per appointment.
 - Irrigate with saline, obtain primary closure, and eliminate bony edges or spicules.
6. Maintain good oral hygiene:
 - Use oral irrigators.
 - Use antimicrobial rinses (chlorhexidine).
 - Use daily fluoride gels.
 - Eliminate smoking.
 - Schedule frequent postoperative recall appointments.

*Alternatives include referral of patient in need of extractions to an oral-maxillofacial surgeon who has experience with such cases and use of hyperbaric oxygen (HBO) therapy after consultation with a medical specialist. HBO treatments often consist of 20 preextraction dives and 10 postsurgical dives.

measures.^{39,48,49} Protocols to reduce the risk of osteoradionecrosis include selection of endodontic therapy over extraction, use of nonlidocaine local anesthetics that contain no or a very low concentration of epinephrine, atraumatic surgical technique (if surgery is necessary), prophylactic antibiotics plus antibiotics during the week of healing (penicillin VK for 7 days), and hyperbaric oxygen therapy before invasive procedures (see [Box 26.12](#)). Hyperbaric oxygen therapy involves sequential daily “dives” under 2 atmospheres of oxygen pressure in a chamber.^{39,48,49}

The use of prophylactic antibiotics to prevent infection in postirradiation (or chemotherapy) patients has not shown any benefit.⁴¹

The effectiveness of antibiotic use (in the case of oral infection), however, can be greatly reduced because of altered blood flow to the affected bone. The dentist should be aware that reduction in blood flow after radiotherapy is much greater in the mandible than in the maxilla because of the limited source and lack of collateral circulation, which accounts for the greater frequency and severity of osteoradionecrosis in the mandible. The use of hyperbaric oxygen treatment at the time of extraction is gaining more support but is costly and cannot be repeated later with the same effect.^{39,48,49}

When necrosis occurs, conservative management usually is indicated. The exposed bone (see [Fig. 26.22](#)) should be irrigated with a saline or antibiotic solution, and the patient should be directed to use oral irrigating devices to clean the involved area. However, extreme pressures should be avoided when use of these devices is prescribed. Bony sequestrum should be removed to allow for epithelialization. If swelling and suppuration are present, broad-spectrum antibiotics are indicated. Severe cases benefit from hyperbaric oxygen treatment (60- to 90-minute dives, 5 days per week, for a total of 20 to 30 dives). Cases that do not respond to conservative measures may require surgical resection of involved bone.^{39,47,48}

Carotid Atheroma. Patients who have received neck irradiation (at a total dose of ≥ 45 Gy) are more likely to develop carotid artery atheromas (calcified atherosclerotic plaques) after treatment than are risk-matched control patients who have not undergone irradiation. These lesions can be detected by panoramic radiography and constitute a risk factor for stroke that warrants referral of the patient to the physician for evaluation.⁴⁹

REFERENCES

1. Siegel RL, Miller KD, Jemal A. Cancer statistics, 2016. *CA Cancer J Clin.* 2016;65:5-29.
2. Thun MJ, Jemal A. Epidemiology of cancer. In: Goldman L, Schafer AI, eds. *Cecil Textbook of Medicine.* 25th ed. Elsevier; 2016:1182-1189, [Chapter 183].
3. <http://www.cancer.org/healthy/findcancerearly/cancer-screeningguidelines/american-cancer-society-guidelines-for-the-early-detection-of-cancer>. 2015.
4. Brawley OW, Cramer BS. Prevention and early detection of cancer. In: Goldman L, Schafer AI, eds. *Cecil Textbook of Medicine.* 25th ed. Elsevier; 2016:1202-1211, [Chapter 185].
5. Lynch HT, Boland CR. Cancer genetics. In: Goldman L, Schafer AI, eds. *Cecil Textbook of Medicine.* 25th ed. Elsevier; 2016:1177-1182, [Chapter 181].
6. National Comprehensive Cancer Network. https://www.nccn.org/professionals/physician_gls/f_guidelines.asp.
7. National Comprehensive Cancer Network. https://www.nccn.org/professionals/physician_gls/_guidelines.asp#headandneck.pdf.
8. U.S. Preventive Services Task Force. Breast cancer: screening. <http://www.uspreventiveservicestaskforce.org/Page/Document/UpdateSummaryFinal/breast-cancer-screening>.
9. U.S. Preventive Services Task Force. Cervical cancer: screening. <http://www.uspreventiveservicestaskforce.org/Page/Document/UpdateSummaryFinal/cervical-cancer-screening>.
10. National Comprehensive Cancer Network. https://www.nccn.org/professionals/physician_gls/f_guidelines.asp#breast.
11. ACS responds to study saying mammography benefit limited. <http://pressroom.cancer.org/index.php?item=234&cs=43>; Accessed 10 August 2011.
12. D'Angelo PC, Galliano DE, Rosemurgy AS. Stereotactic excisional breast biopsies utilizing the advanced breast biopsy instrumentation system. *Am J Surg.* 1997;174:297-302.
13. CDC. Human Papillomavirus (HPV) and Cancer. <https://www.cdc.gov/cancer/hpv.2016>.
14. Schiffman M, Khan MJ, Solomon D, et al. A study of the impact of adding HPV types to cervical cancer screening and triage tests. National Cancer Institute. 2005. jnci.oxfordjournals.org.
15. Chaturvedi AK, Engels EA, Pfeiffer RM, et al. Human papillomavirus and rising oropharyngeal cancer incidence in the United States. *J Clin Oncol.* 2011;jco.ascpubs.org.
16. U.S. Preventive Services Task Force. <http://www.uspreventiveservicestaskforce.org/Page/Document/UpdateSummaryFinal/colo-rectal-cancer-screening>.
17. Statistics on colorectal cancer, SEER <http://seer.cancer.gov/statfacts/html/colorect.html>; Accessed 23 March 2015.
18. Ettinger D. Colo-rectal cancer: diagnosis and treatment. In: Goldman L, Schafer AI, eds. *Cecil Textbook of Medicine.* 25th ed. Elsevier; 2016:1264-1273, ISBN 978-1-4377-1604-7, [Chapter 197].
19. Sousville EA, Longo DL. Principles of cancer treatment. In: Goldman L, Schafer AI, eds. *Cecil Textbook of Medicine.* 25th ed. Elsevier; 2016:1222-1229, ISBN 978-1-4377-1604-7, [Chapter 86].
20. https://www.nccn.org/professionals/physician_gls/pdf/colo-rectalcancer.pdf. 2016.
21. Statistics on lung cancer; <http://seer.cancer.gov/statfacts/html/lungb.html>; Accessed 23 March 2016.
22. Schuchter L. Lung cancer diagnosis and treatment. In: Goldman L, Schafer AI, eds. *Cecil Textbook of Medicine.* 25th ed. Elsevier; 2016:1329-1338, ISBN 978-1-4377-1604-7, [Chapter 210].

23. U.S. National Library of Medicine. Lung cancer. <https://ghr.nlm.nih.gov/condition/lung-cancer>.
24. U.S. Preventive Services Task Force. <http://www.uspreventiveservicestaskforce.org/Page/Document/UpdateSummaryFinal/lung-cancer-screening>.
25. Ozen M, Pathak S. Prostate cancer. In: Goldman L, Schafer AI, eds. *Cecil Textbook of Medicine*. 25th ed. Elsevier; 2016:1819-1838, ISBN 978-1-4377-1604-7, [Chapter 216].
26. U.S. Preventive Services Task Force. <http://www.uspreventiveservicestaskforce.org/Page/Document/UpdateSummaryFinal/colo-rectal-cancer-screening>.
27. Parker F. Skin diseases of general importance. In: Goldman L, Schafer AI, eds. *Cecil Textbook of Medicine*. 25th ed. Elsevier; 2016:2001-2013, ISBN 978-1-4377-1604-7, [Chapter 221].
28. U.S. National Library of Medicine. <http://medlineplus.gov/skincancer.html>.
29. U.S. National Library of Medicine. <https://medlineplus.gov/melanoma.html>.
30. Silverman S Jr. *Oral Cancer*. 4th ed. Hamilton, Ontario, Canada: BC Decker; 1998.
31. Rhodus NL. Oral cancer: leukoplakia and squamous cell carcinoma. *Dent Clin North Am*. 2005;49:143-165, ix.
32. Rhodus NL, Kerr AR, Patel K. Oral cancer: leukoplakia and squamous cell carcinoma. In: Lesions Oral, Sollectio TS, eds. *Dental Clinics of North America*. 2014; 57(3):143-156. ISBN-978-0-323-28995-5, [Chapter 6].
33. Rhodus NL. Oral cancer and precancer: improving outcomes. *Compend Contin Educ Dent*. 2009;30: 486-488, 490-494, 496-498.
34. <https://ghr.nlm.nih.gov/.../fanconi-anemia>.
35. Million RR, Cassisi NJ. *Management of Head and Neck Cancer: A Multidisciplinary Approach*. Philadelphia, PA: J. B. Lippincott Co.; 2006.
36. National Cancer Institute. Drugs approved for head and neck cancer. <http://www.cancer.gov/about-cancer/treatment/drugs/head-neck>.
37. D'Cruz A, Gupta S, Vaish R, et al. Elective versus therapeutic neck dissection in head and neck cancer treatment. *N Engl J Med*. 2015;373:2475-2478.
38. MASCC/ISOO for the management of patients with mucositis). <http://www.mascc.org/isoo-publications>.
39. Rhodus NL. Management of oral complications from radiation and chemotherapy. *Northwest Dent*. 2010;89:39-42.
40. http://www.mascc.org/assets/documents/Oral_Care-SummaryOral_Complications_Systematic_Reviews.pdf.
41. Johnson E, Babb J, Sridhar D. Routine antibiotic prophylaxis for totally implantable venous access device placement: meta-analysis of 2,154 patients. *J Vasc Interv Radiol*. 2016;27(3):339-343. doi:10.1016/j.jvir.2015.11.051. [Epub 2016 Jan 6].
42. Hanchanale S, Adkinson L, Daniel S, et al. Systematic literature review: xerostomia in advanced cancer patients. *Support Care Cancer*. 2015;23:881-888. doi:10.1007/s00520-014-2477-8.
43. Eisbruch A, Rhodus N, Rosenthal D, et al. The prevention and treatment of radiotherapy-induced xerostomia. *Semin Radiat Oncol*. 2003;13:302-308.
44. LeVeque FG, Montgomery M, Potter D, et al. A multicenter, randomized, double-blind, placebo-controlled, dose-titration study of oral pilocarpine for treatment of radiation-induced xerostomia in head and neck cancer patients. *J Clin Oncol*. 1995;114: 1141-1149.
45. Rhodus NL. Dysphagia in post-irradiation therapy head and neck cancer patients. *J Cancer Res Ther Control*. 1994;4:49-54.
46. Proceedings of the International Conference on Novel Anti-caries and Remineralizing Agents. Vina del Mar, Chile, January 10-12, 2008. *Adv Dent Res*. 2009;21:3-89.
47. McKenzie MR, Wong FL, Epstein JB, et al. Hyperbaric oxygen and postradiation osteonecrosis of the mandible. *Eur J Cancer B Oral Oncol*. 1993;29B:201-207.
48. Epstein J, van der Meij E, McKenzie M, et al. Postradiation osteonecrosis of the mandible: a long-term follow-up study. *Oral Surg Oral Med Oral Pathol Oral Radiol Endod*. 1997;83:657-662.
49. Freymiller EG, Sung EC, Friedlander AH. Detection of radiation-induced cervical atheromas by panoramic radiography. *Oral Oncol*. 2000;36:175-180.

Neurologic, Behavioral, and Psychiatric Disorders

Neurologic Disorders

Neurologic diseases are common in the general population, and they will become even more common as the population ages. Therefore, dental patients will regularly present with neurologic conditions. Several diseases affecting the nervous system are of clinical significance in dental practice. These diseases may vary in severity and consequences. The focus of this chapter is on five of the more common and significant neurologic diseases—**stroke, Parkinson disease, Alzheimer disease, epilepsy, and multiple sclerosis (MS)**. Also discussed are cerebrospinal fluid (CSF) shunts because of the assumed risk of bacterial seeding after an invasive dental procedure in patients with such shunts.

CRITICAL COMPLICATIONS: Patients with neurologic diseases are at high risk during dental treatment for complications such as stroke, myocardial infarction (MI), adverse bleeding, altered consciousness, and infection. These events could prove serious or fatal. The dentist must be able to detect these patients, based on history and clinical findings, refer them for medical diagnosis and management, and work closely with their physicians to develop dental management plans that will be effective and safe for these patients.¹⁻⁴

STROKE (CEREBROVASCULAR ACCIDENT)

DEFINITION

Stroke is a generic term that is used to refer to a cerebrovascular accident (CVA)—a serious and often fatal neurologic event caused by sudden interruption of oxygenated blood to the brain. The associated ischemic injury results in focal necrosis of brain tissue, which may be fatal if the damage is catastrophic.^{1,2} Even if a stroke is not fatal, the survivor often is debilitated in motor function, speech, or cognition to a certain degree. The scope and health impact of stroke are reflected in the fact that stroke is the leading cause of serious, long-term disability in the United States; 5% of the population older than 65 years of age has had at least one stroke.³⁻⁵

EPIDEMIOLOGY

Stroke is one of the most significant health problems in the United States. Stroke is the fifth leading cause of death

in the United States, with more than 130,000 Americans dying of stroke annually.³⁻⁵ Each year in the United States, about 800,000 people experience new or recurrent stroke. Three of four of these (600,000) are new strokes. This figure translates to the occurrence of one stroke about every 4 minutes; 75% of persons survive their stroke.

Ischemic stroke accounts for 87% of all strokes in the United States.³⁻⁵

An estimated 6.6 million Americans have had a stroke. Overall stroke prevalence during the period from 2009 to 2012 was an estimated 2.6% (National Health and Nutrition Examination Survey, National Heart, Lung, and Blood Institute). According to data from the 2013 BRFSS (Centers for Disease Control and Prevention), 2.7% of men and 2.7% of women had a stroke in this time period.³⁻⁵

Hypertension is the most important risk factor for ischemic and hemorrhagic stroke.^{6,7} The incidence of stroke increases directly in relation to the degree of elevation of systolic and diastolic arterial blood pressure above threshold values. More important, conclusive evidence accrued since 1980 indicates that control of hypertension prevents strokes. Metaanalyses of randomized controlled trials confirm an approximate 30% to 40% reduction in stroke risk with lowering of blood pressure.^{6,7}

Approximately 7% to 10% of men and 5% to 7% of women older than 65 years of age have asymptomatic carotid stenosis of greater than 50%. Epidemiologic studies suggest that the rate of unheralded stroke evolving ipsilateral to a stenosis is about 1% to 2% annually.³⁻⁵

Nonvalvular atrial fibrillation carries a 3% to 5% annual risk for stroke, with the risk becoming even higher in the presence of advanced age, previous transient ischemic attack (TIA) or stroke, hypertension, impaired left ventricular function, and diabetes mellitus.¹⁻³

Individuals who have a TIA and survive the initial high risk period have a 10-year stroke risk of roughly 19% and a combined 10-year stroke, MI, or vascular death risk of 43% (4% per year).³⁻⁶ In epidemiologic studies, the risk for stroke in smokers is almost double that in nonsmokers, but the risk becomes essentially identical to that in nonsmokers by 2 to 5 years after quitting. The relative risk for stroke is two to six times greater for patients with insulin-dependent (type 1) diabetes.^{1,3,5} An association with race has been recognized:

Compared with whites, African Americans are at 38% greater risk for a first stroke with a similar greater risk of death.¹⁻⁵ Also, 40,000 more women than men have a stroke each year. Risk of stroke increases with age; however, on average, 28% of people who have a stroke are younger than 65 years of age.³⁻⁵ There are nearly 5 million stroke survivors living in the United States, and an average dental practice of 2000 adult patients will include about 31 patients who have had or will experience a stroke.³⁻⁵

Pathophysiology and Complications

Stroke is caused by the interruption of blood supply and oxygen to the brain as a result of ischemia or hemorrhage. The most common type is ischemic stroke induced by thrombosis (in up to 80% of cases) of a cerebral vessel. Ischemic stroke also can result from occlusion of a cerebral blood vessel by distant emboli. Hemorrhage causes about 15% of all strokes and carries a 1-year mortality rate greater than 60%.¹⁻⁵

Cerebrovascular disease is the primary factor associated with stroke. Atherosclerosis and cardiac pathosis (MI, atrial fibrillation) increase the risk of thrombotic and embolic strokes, but hypertension is the most important risk factor for intracerebral hemorrhagic stroke.^{1-5,7} Approximately 10% of persons who have had an MI will have a stroke within 6 years. Additional factors that increase the risk for stroke include the occurrence of TIAs, a previous stroke, high dietary fat, obesity and elevated blood lipid levels, physical inactivity, uncontrolled hypertension, cardiac abnormalities, diabetes mellitus, elevated homocysteine levels, elevated hematocrit, elevated antiphospholipid antibodies, heavy tobacco smoking, increasing age (risk doubles each decade after the age of 65 years), and periodontal disease.¹⁻⁶ Heart failure (see Chapter 6) also predisposes the patient to ischemic stroke, the risk for which is twice as high.^{1,2,6} Increased risk for hemorrhagic stroke also occurs with use of phenylpropanolamine, an α -adrenergic agonist.^{1,2,6}

Pathologic changes associated with stroke result from infarction, intracerebral hemorrhage, or subarachnoid hemorrhage (SAH). Cerebral infarctions most commonly are caused by atherosclerotic thrombi or emboli of cardiac origin. The extent of an infarction is determined by a number of factors, including the site of the occlusion, size of the occluded vessel, duration of the occlusion, and collateral circulation. The production and circulation of proinflammatory cytokines, the occurrence of clotting factors, and arterial inflammation contribute to platelet aggregation. Neurologic abnormalities result from excitotoxicity, free radical accumulation, inflammation, mitochondrial and DNA damage, and apoptosis of the region supplied by the damaged artery.^{1,2,6}

The most common cause of intracerebral hemorrhage is hypertensive atherosclerosis, which results in microaneurysms of the arterioles (Fig. 27.1). Vessels within the circle of Willis often are affected (Fig. 27.2). Rupture of

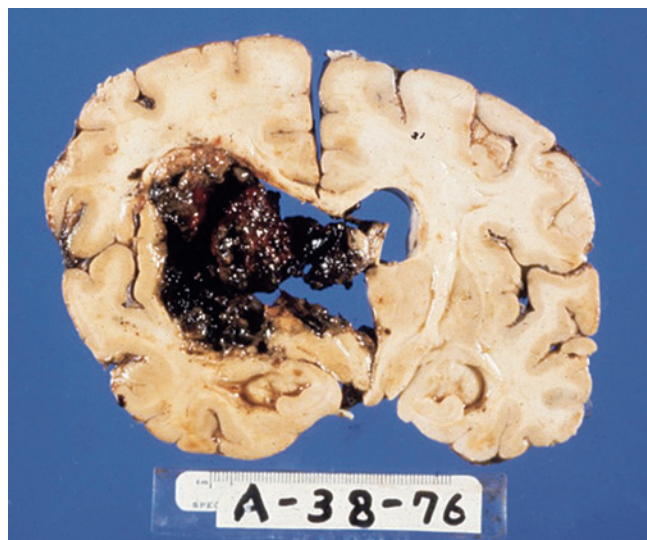

FIG 27.1 Cerebral infarction in a patient who had chronic hypertension.

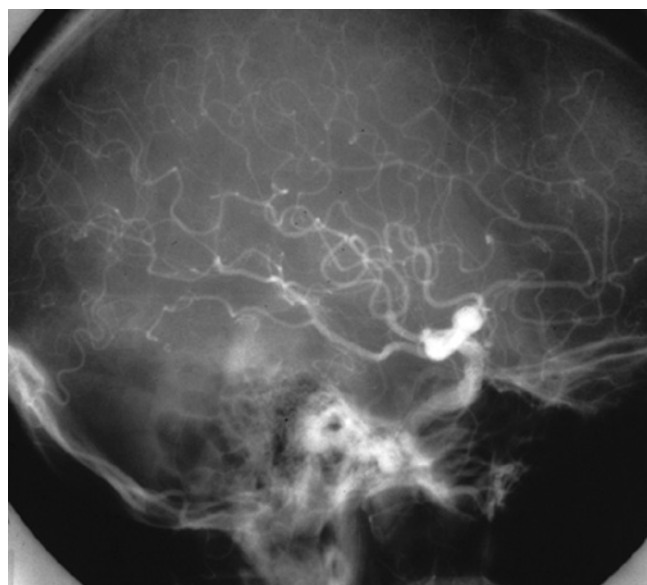

FIG 27.2 Aneurysm of the middle cerebral artery.

these microaneurysms within brain tissue leads to extravasation of blood, which displaces brain tissue, causing an increase in intracranial volume until resultant tissue compression halts bleeding. Hemorrhagic strokes also may be caused by SAH. The most common cause of SAH is rupture of a saccular aneurysm at the bifurcation of a major cerebral artery.^{1,2,6,7}

The most serious outcome of stroke is death, which occurs in 8% of those who experience ischemic strokes and 38% to 47% of those with hemorrhagic strokes within 1 month of the event. Overall, about 23% of patients die within 1 year.⁷⁻¹⁰ Mortality rates are directly related to type of stroke, with 80% of patients dying after an intracerebral hemorrhage, 50% after an SAH,

and 30% after occlusion of a major vessel by a thrombus. Death from stroke may not be immediate (sudden death) but rather may occur hours, days, or even weeks after the initial stroke episode.⁷⁻¹⁰

If the victim survives, it is highly likely that a neurologic deficit or disability of varying degree and duration will remain. Of those who survive the stroke, **10% recover with no impairment**, 50% have a mild residual disability, 15% to 30% are disabled and require special services, and 10% to 20% require institutionalization. Approximately 50% of those who survive the acute period (the first 6 months) are alive 7 years later.⁶⁻¹⁰

The type of residual deficit that results from a stroke is directly dependent on the size and location of the infarct or hemorrhage. Deficits include unilateral paralysis, numbness, sensory impairment, dysphasia, blindness, diplopia, dizziness, and dysarthria. Return of function is unpredictable and usually takes place slowly, over several months. Even with improvement, patients frequently are left with some permanent residual problem, such as difficulty in walking, using the hands, performing skilled acts, or speaking. Dementia also may be an outcome of stroke.⁶⁻¹⁰

CLINICAL PRESENTATION

Familiarity with the warning signs and symptoms and the phases of stroke can lead to appropriate action that may be lifesaving. Four events associated with stroke are (1) the TIA, (2) reversible ischemic neurologic deficit (RIND), (3) stroke-in-evolution, and (4) the completed stroke. These events are defined principally by their duration.⁹⁻¹³

A TIA is a “mini” stroke that is caused by a temporary disturbance in blood supply to a localized area of the brain. A TIA often is associated with numbness of the face, arm, or leg on one side of the body (hemiplegia) and weakness, tingling, numbness, or speech disturbances that usually last less than 10 minutes. Most commonly, a major stroke is preceded by one or two TIAs within several days of the first attack.⁷⁻¹⁰

A RIND is a neurologic deficit that is similar to a TIA but does not clear within 24 hours. Eventual recovery is the rule, however.⁷⁻¹⁰

Stroke-in-evolution is a neurologic condition that is caused by occlusion or hemorrhage of a cerebral artery in which the deficit has been present for several hours and continues to worsen during a period of observation. Signs of stroke include hemiplegia; temporary loss of speech or trouble in speaking or understanding speech; temporary dimness or loss of vision, particularly in one eye (may be confused with migraine); unexplained dizziness; unsteadiness; or a sudden fall.⁶⁻¹⁰

Clinical manifestations that remain after a stroke vary in accordance with the site and size of residual brain deficits; these include language disorders, hemiplegia, and paresis; the latter is a form of paralysis that is associated

BOX 27.1 Manifestations of Right-Sided Versus Left-Sided Brain Damage

Right-Sided Brain Damage	Left-Sided Brain Damage
<ul style="list-style-type: none"> • Paralyzed left side • Spatial-perceptual deficits • Impaired thought process • Quick, impulsive behavior • Inability to use mirror • Difficulty performing tasks (toothbrushing) • Memory deficits—for events or people, generalized • Neglect of left side 	<ul style="list-style-type: none"> • Paralyzed right side • Language and speech problems • Decreased auditory memory (inability to remember long instructions) • Slow, cautious, disorganized behavior • Memory deficits—language based • Anxiety

with loss of sensory function and memory and weakened motor power. **Box 27.1** presents the different behavioral manifestations of right- versus left-sided brain damage. Of note, in most patients with stroke, the intellect remains intact; however, massive left-sided stroke has been associated with cognitive decline.^{3,8,9}

Laboratory and Diagnostic Findings

Patients suspected of having had a stroke usually undergo a variety of laboratory tests and diagnostic imaging procedures to rule out conditions that can produce neurologic alterations, such as diabetes mellitus, uremia, abscess, tumor, acute alcoholism, drug poisoning, and extradural hemorrhage.^{1,2,5} Such investigations often include urinalysis, blood sugar level, complete blood count, erythrocyte sedimentation rate, serologic tests for syphilis, blood cholesterol and lipid levels, chest radiographs, and electrocardiography (ECG). Various abnormalities may be disclosed by the test results, depending on the type and severity of stroke and its causative factors. A lumbar puncture also may be ordered by the physician to check for blood or protein in the CSF and for altered CSF pressure, which would be suggestive of SAH.^{1,2,5} Doppler blood flow studies, EEG, cerebral angiography, computed tomography (CT) (**Fig. 27.3**), and magnetic resonance imaging (MRI, including diffusion and perfusion studies of the brain) are important for determining the extent and location of arterial injury.^{1,2,10}

MEDICAL MANAGEMENT

The first aspect of stroke management is prevention. This is accomplished by identifying specific risk factors (e.g., hypertension, diabetes, atherosclerosis, cigarette smoking) and attempting to reduce or eliminate as many of these as possible. Blood pressure–lowering (see **Chapter 3**), antiplatelet therapy (see **Chapter 24**), and statin therapy are primary stroke prevention methods. Carotid endarterectomy is a secondary stroke prevention method.^{1,2,5}

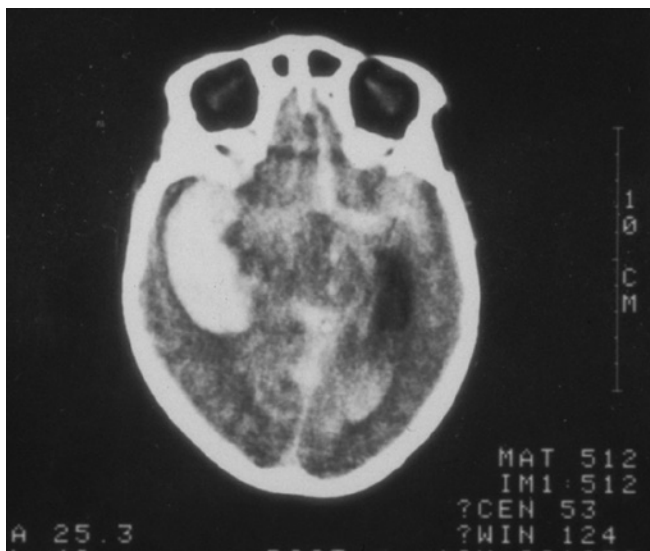

FIG 27.3 Computed tomography scan of the brain demonstrating a cerebrovascular accident (stroke) lesion that extended from the midbrain to the temporal lobe.

The benefit of lowering blood pressure is evident in the fact that a reduction of systolic blood pressure by 10 mm Hg is associated with a one-third reduction in risk for stroke.^{1,2,5} Regimens of aspirin, ticlopidine, or extended-release dipyridamole are accepted preventive therapies for ischemic stroke in patients who have experienced TIAs or who have had a stroke. Aspirin dosed at 81 to 325 mg daily, can effectively reduce the risk of stroke by preventing emboli.¹¹⁻¹³ Likewise, surgical intervention through endarterectomy reduces the risk by about 1% per year, such that one stroke is prevented for every 20 patients who undergo surgery over a 5-year period.¹¹⁻¹³

Treatment for stroke generally has three components. The immediate task is to sustain life during the period immediately after the stroke. This is done by means of life support measures and transport to a hospital. The second task involves emergency efforts to prevent further thrombosis or hemorrhage and to attempt to lyse the clot in cases of thrombosis or embolism. Thrombolysis and improved neurologic outcomes have been achieved with intravenous (IV) recombinant tissue-type plasminogen activator (rt-PA) and intraarterial prourokinase. Of the two, IV administration of rt-PA within 3 hours of ischemic stroke onset is the only approved therapy in the United States.¹¹⁻¹³

After the initial period, efforts to stabilize the patient continue with anticoagulant medications such as heparin, coumarin, aspirin, and dipyridamole combined with aspirin (Aggrenox) in cases of thrombosis or embolism. Whereas heparin is administered intravenously during acute episodes, coumarin, dipyridamole, aspirin, subcutaneous low-molecular-weight heparin, or platelet receptor antagonists (clopidogrel, abciximab, ticlopidine) are used for prolonged periods to reduce risk of thrombosis (e.g.,

deep vein thrombosis).^{1,2,9,12,13} Corticosteroids may be used acutely after a stroke to lessen the cerebral edema that accompanies cerebral infarction. Such therapy can markedly reduce the likelihood of complications. Surgical intervention may be indicated for removal of a superficial hematoma or management of a vascular obstruction. The latter usually is accomplished by thromboendarterectomy or by use of bypass grafts in the neck or thorax. Diazepam, phenytoin, and other anticonvulsants are prescribed in the management of seizures that may accompany the postoperative course of stroke.^{1,2,9,12,13}

If the patient survives, the third and final task consists of institution of preventive therapy, administration of medications that reduce the risk of another stroke (statins and antihypertensive drugs), and initiation of rehabilitation. Rehabilitation generally is accomplished by intense physical, occupational, and speech therapy (if indicated). Although marked improvement is common, many patients are left with some degree of permanent deficit.^{1,2,9,12,13}

Numerous strategies are being evaluated for treating acute ischemic stroke (AIS). These include intraarterial thrombolysis (IAT); augmentation of rt-PA with other medications, thereby enlarging the therapeutic window (i.e., lengthening the period of efficacy); and neuroprotection.^{12,13} IAT may be a treatment option for selected patients. Possible selection criteria include presentation between 3 and 6 hours from symptom onset, major cerebral artery occlusion, severe neurologic deficits, and high risk of systemic hemorrhage with IV rt-PA (e.g., recent surgery). In most circumstances, the availability of IAT should not preclude the use of IV rt-PA in patients meeting appropriate criteria. IAT requires access to emergent cerebral angiography, experienced stroke physicians, and neurointerventionalists; it should be performed only at a clinical center with considerable expertise in this technique.^{12,13}

The MERCI (Mechanical Embolus Removal in Cerebral Ischemia) retrieval system (Concentric Medical, Inc., Mountain View, CA) has been approved by the U.S. Food and Drug Administration (FDA) for recanalizing acutely occluded cerebral arteries. In the Multi-MERCI study, patients who did not improve immediately after IV rt-PA underwent mechanical embolectomy within 8 hours of symptom onset. Partial or complete recanalization occurred in 74% of patients, with a symptomatic intracerebral hemorrhage rate of 6.7%.^{12,13}

Another, newer FDA-approved device for AIS is the **Penumbra stroke system** (Penumbra, Inc., Alameda, CA).^{12,13} This device combines two methods of clot extraction, aspiration and mechanical extraction. First the clot is aspirated; then a thrombus removal ring can be used if necessary to remove remaining clot.^{12,13}

DENTAL MANAGEMENT

Important public health roles of dentists are that of educator in stroke prevention and as an identification of

BOX 27.2 Risk Factors for Stroke

- Hypertension*
- Congestive heart failure*
- Diabetes mellitus*
- History of TIAs or previous CVA*
- Age older than 75 years*
- Hypercholesterolemia
- Coronary atherosclerosis
- Smoking tobacco

CVA, Cerebrovascular accident (stroke); TIA, transient ischemic attack.

*The risk of stroke increases by a factor of 1.5 for each of these conditions. With the combination of several factors, the risk obviously becomes much greater.

stroke-prone patients. Patients with a history or clinical evidence of hypertension, congestive heart failure, diabetes mellitus, previous stroke or TIA, and advancing age are predisposed to stroke, as well as to MI. As these factors increase in frequency, so does the level of risk^{1,2,9,10,14,15} (Box 27.2). The dentist should assess patient risk, encourage persons with risk factors to seek medical care, and eliminate or control all possible risk factors^{1,2,9,10,14,15} (see Box 27.4).

Assessment of risk aids in the decision-making process regarding the timing and type of dental care to be provided. For example, the risk of stroke is greater in a patient who has had a previous stroke or TIA than in a person who has not had either.^{9,10,14} In fact, up to one third of strokes recur within 1 month of the initial event, and risk remains elevated for at least 6 months.¹⁴ A degree of caution is therefore indicated in the approach to dental treatment of persons with a history of stroke or TIA, and deferral of treatment is advised for 6 months. Although risk decreases after 6 months, it continues to be present; 14% of those who survive a stroke or TIA have a recurrence within 1 year.^{9,10,14} In addition, patients who have recently experienced a TIA or RIND are clinically unstable and should not undergo elective dental care. Medical consultation and referral to a physician are mandatory^{9,10,14} (Box 27.3).

Patients who take coumarin or antiplatelet drugs are at risk for abnormal bleeding (see Box 27.2). The status of coumarin anticoagulation is monitored by assessment of the international normalized ratio (INR). An INR level of 3.5 or less is acceptable for performance of most invasive and noninvasive dental procedures. If the INR is greater than 3.5 and oral surgery is planned, significant bleeding may occur, and the physician should be consulted regarding a decrease in dosage of the anticoagulant. In such cases, a reduction in dose of the anticoagulant is recommended over interruption of anticoagulation therapy because the risk for significant adverse outcomes is minimized by this approach (see Chapter 24).^{9,10,14}

Data indicate that post-CVA patients in whom the usual anticoagulant regimen is altered before undergoing

dental treatment are at risk for adverse events.^{14,15} Therefore, it is advisable to not adjust the anticoagulant regimen unless consultation with the physician permits it.^{14,15} Also, metronidazole and tetracycline may increase the INR by inhibiting the metabolism of warfarin (Coumadin); therefore, concurrent use of these drugs probably should be avoided.^{14,15} Aspirin should be avoided for management of postoperative dental pain, which is better managed with acetaminophen^{10,15} (see Box 27.3).

Patients whom have recently undergone a stroke may be safely and effectively managed in the dental clinic without complications as long as the patient is carefully identified and monitored according to his or her status.^{10,15} Management of stroke-prone patients or patients with a history of stroke includes the use of short, midmorning appointments that are free of stress and anxiety. Nitrous oxide–oxygen may be given if good oxygenation is maintained at all times.^{10,15} Assisted transfer to the dental chair may be needed. It is important not to overestimate the patient's abilities, especially because good verbalization skills may mask a surprising lack of self-awareness regarding the extent of paresis that is present, reflecting a “neglect” syndrome. Dental care providers should move slowly around the patient and should speak clearly, with the mask off, while facing the patient. Effective communication techniques are listed in Box 27.4.^{10,15}

Blood pressure should be monitored to ensure good control. Pulse oximeter monitoring is indicated to ensure that oxygenation is adequate. Pain control is important; therefore, adequate anesthesia is essential. A local anesthetic with 1 : 100,000 or 1 : 200,000 epinephrine may be used in judicious amounts (4 mL or less). Gingival retraction cord impregnated with epinephrine should not be used.^{9,10,14,15}

A patient who develops signs or symptoms of a stroke in the dental office should receive oxygen, and the emergency medical services (EMS) system should be activated. Transport to a medical facility should not be delayed (minutes count in the treatment of patients with acute stroke). For ischemic stroke, thrombolytic agents should be administered within 3 hours if they are to be maximally effective in reestablishing arterial flow; the earlier patients receive these agents, the better the outcome.¹⁶ The phrase “time is brain” emphasizes the urgency of the situation. Finally, the dental staff should recognize that patients who have had a stroke typically experience feelings of grief, loss, and depression and should be treated with compassion.

Technical modifications may be required for patients with residual physical deficits who have difficulty in practicing adequate oral hygiene. For these patients, extensive bridgework is not a good choice. However, fixed prostheses may be more desirable than removable ones because of difficulties associated with daily placement and removal. Individualized treatment plans are important. All restorations should be placed with ease of cleansability in mind. Hygiene often is facilitated by an electric

BOX 27.3 Dental Management Considerations in Patients With History of a Stroke**P****Patient Evaluation and Risk Assessment (See Box 1.1)**

- Evaluate to determine the nature, severity, control, and stability of disease.

Potential Issues and Factors of Concern**A**

Antibiotics	Avoid use of metronidazole and tetracyclines in patients taking warfarin (Coumadin) because of its decreased metabolism.
Anesthetics	Good pain control should be achieved during the procedure, but the dose of epinephrine should be limited to two carpules; no epinephrine-containing retraction cord should be used.
Analgesics	Use of acetaminophen as pain reliever is recommended; avoid the use of ASA and other NSAIDs (including for postoperative pain) because of increased risk of bleeding.

B

Bleeding	<p>Patients taking an anticoagulant or on antiplatelet therapy are at increased risk for bleeding:</p> <ul style="list-style-type: none"> Aspirin ± dipyridamole (Aggrenox), clopidogrel (Plavix), abciximab (ReoPro), or ticlopidine (Ticlid) Coumarin—pretreatment INR \leq3.5. Higher levels require consultation with physician to reduce dose. Heparin, intravenous—use palliative emergency dental care only, or 6–12 hours before surgery, discontinue heparin and start another anticoagulant (e.g., warfarin [Coumadin]) with physician's approval. Then restart heparin after clot forms (6 hours later). Heparin, subcutaneous (low molecular weight)—generally, no changes required. <p>Use measures that minimize hemorrhage (atraumatic surgery, pressure, Gelfoam, suturing) as needed. Have available nonadrenergic hemostatic agents and devices (stents, electrocautery unit). Additional steps should be taken to achieve hemostasis in patients on an anticoagulant or antiplatelet therapy.</p>
----------	--

Blood pressure Monitor blood pressure and oxygen saturation.

C

Cardiac	Blood pressure should be monitored throughout appointment during dental procedures.
Chair position	Deficits from a previous stroke may warrant assistance for patient transfer to the chair, effective oral evacuation and airway management, and rigorous oral hygiene measures delivered by a health care provider.

D

Drugs	Use minimum amount of anesthetic containing a vasoconstrictor. Avoid use of epinephrine-impregnated retraction cord. Also avoid the use of metronidazole and tetracyclines in patients taking warfarin (Coumadin) because these agents cause decreased warfarin metabolism.
-------	---

E

Emergencies	Only emergency treatment procedures should be done within 6 months of TIA, RIND, or stroke. Appointments should be short and stress free, with good anesthesia achieved using nitrous oxide–oxygen. Monitoring of blood pressure and oxygen saturation is indicated throughout the procedure. Recognize signs and symptoms of a stroke, provide emergency care, and activate EMS system as needed.
Equipment	No issues

EMS, Emergency medical services; INR, international normalized ratio; IV, intravenous; RIND, reversible ischemic neurologic deficit; TIA, transient ischemic attack.

toothbrush, a large-handled toothbrush, or a water irrigation device. Flossing aids should be prescribed, and family members and personal care providers should be instructed on how and when these services should be provided. Frequent professional prophylaxis and the provision of topical fluoride and chlorhexidine are advisable.^{10,15}

Oral Manifestations and Complications

A stroke-in-evolution may become apparent as slurred speech, weak muscles, or difficulty swallowing. After a stroke, complete loss of or difficulty in speech, unilateral paralysis of the orofacial musculature, and loss of sensory stimuli of oral tissues may occur. The tongue may be

flaccid, with multiple folds, and may deviate on extrusion. Dysphagia is common, along with difficulty in managing liquids and solids. Patients with right-sided brain damage may neglect the left side. Thus, food and debris may accumulate around the teeth, beneath the tongue, or in alveolar folds. Patients may need to learn to clean their teeth or dentures with only one hand, or they may require assistance to maintain oral hygiene; otherwise, caries, periodontal disease, and halitosis occur commonly.

Calcified atherosclerotic plaques have been demonstrated on panoramic films in the carotid arteries of older patients and patients with diabetes¹⁷⁻¹⁹ (Fig. 27.4). This radiographic feature indicates a risk for stroke and

BOX 27.4 Effective Communication Techniques for Patients Who Have Had a Stroke

- Face the patient.
- Use a slower, more deliberate, less complex pattern of speech.
- Communicate at eye level.
- Be positive.
- Ask “yes-or-no” questions—be simple and brief.
- Give frequent, accurate, and immediate feedback.
- Use simple drawings to explain procedures.
- Do not underestimate or overestimate abilities.
- Do not raise voice or use baby talk.
- Do not wear a mask when talking to the patient.
- Communicate also with significant other or personal care provider.

Data from Henry R, personal communication, 1995; and Ostuni E: Stroke and the dental patient, *J Am Dent Assoc* 125:721-727, 1994.



FIG 27.4 Carotid atheroma in an older adult patient at risk for stroke. The calcification usually is located near cervical vertebrae 3 and 4, generally at a 45-degree angle from the angle of the mandible.

warrants referral to the patient’s physician for evaluation. Also of note, severe periodontal bone loss is associated with carotid artery plaques and increased risk for stroke. However, the exact causative relationship between periodontal disease and stroke remains to be defined. Although periodontal treatment can reduce serum inflammatory markers potentially involved in stroke, evidence that periodontal therapy reduces the risk for stroke is lacking.⁹⁻¹⁵

PARKINSON DISEASE

GENERAL DESCRIPTION

Parkinson disease is a progressive neurodegenerative disorder of neurons that produce dopamine. Loss of these

neurons results in characteristic motor disturbances—resting tremor, muscular control and rigidity, movement, bradykinesia, and postural instability.^{20,21} Dopaminergic neurons are found in the nigrostriatal pathway of the brain. Approximately 80% of the dopamine in these neurons must be depleted before symptoms of the disease emerge. This disease is chronic and progressive, and there is no cure.²⁰⁻²²

There are three types of Parkinson disease:²⁰⁻²²

1. **Adult-onset Parkinson disease**, which is the most common form. The average age at onset is approximately 60 years. Of course, as with all Parkinson disease, the condition is progressive.
2. **Young-onset Parkinson disease** for which the average age at onset is between 20 and 40 years
3. **Juvenile Parkinson disease** for which age at onset is before 21 years. This form is quite rare.

EPIDEMIOLOGY

The incidence of Parkinson disease, which is the second most common neurodegenerative disorder after Alzheimer disease, is between 8 and 19 per 100,000 people in the United States and more than 1.5 million people. Parkinson disease occurs in approximately 1 in 1000 people in the general population and greater than 2% of persons older than 65 years and 5% in persons older than 85 years.²⁰⁻²² Each year, this disease is diagnosed in 50,000 persons. Men are affected slightly more often than women.²⁰⁻²² In keeping with the aging phenomenon in the United States, a three- to fourfold increase in Parkinson disease frequency is predicted over the next 50 years. Parkinson disease has a peak age at onset between 55 and 66 years, but a particular form of the disease can strike teenagers. An average dental practice of 2000 adult patients is predicted to include about 4 patients who have Parkinson disease.^{22,23}

Pathophysiology and Complications

Parkinson disease is caused by death and depletion of dopaminergic neurons, which are manufactured in the substantia nigra (Fig. 27.5) and released in the caudate nucleus and putamen (the nigrostriatal pathway).^{20,21}

The etiology of Parkinson disease is believed to be a variable combination of poorly understood genetic and environmental factors. Both autosomal dominant and recessive genes can cause classic Parkinson disease. The protein α -synuclein, which is the chief constituent of the hallmark cytoplasmic inclusion, the Lewy body, is critical in the pathogenesis of Parkinson disease.²³ Abnormal aggregation of the protein, either from mutations in the α -synuclein gene or occurring as a result of excessive production of the normal protein caused by gene duplications or triplications, is associated with various disease phenotypes. Other defined genetic abnormalities may be associated with classic later-onset Parkinson disease, including *LRRK2*, which is currently the most common



FIG 27.5 Parkinson disease. Normal pigmentation of dopaminergic neurons in the substantia nigra of a healthy patient (*top*) in contrast with depleted and depigmented dopaminergic neurons of the substantia nigra in a patient who has Parkinson disease (*bottom*).

cause of autosomal dominantly inherited Parkinson disease, or with early-onset parkinsonism, typically found in the autosomal recessive forms associated with *parkin*, *DJ-1*, and *PINK1*. Other genes in which mutations may increase the risk for development of Parkinson disease include the glucocerebrosidase gene (*GBA*) in Ashkenazi Jews.^{20,23}

Other causes include stroke, brain tumor, and head injury (e.g., boxing) that damage cells in the nigrostriatal pathway.^{20,21} Exposure to manganese (in miners and welders), mercury, carbon disulfide, certain agricultural herbicides (rotenone), and street heroin contaminated with a meperidine analogue (1-methyl-4-phenyl-1,2,3,6-tetrahydropyridine) can be neurotoxic, giving rise to Parkinson disease symptoms. Also, neuroleptic drugs (phenothiazines, butyrophenones) may cause parkinsonian symptoms and rigidity.^{20,21}

Parkinson disease is thought to be caused by environmental and genetic factors that trigger failure in proteasome-mediated protein turnover in susceptible neurons, resulting in accumulation of toxic proteins.^{20,21} This toxicity leads to degeneration and loss of pigmented neurons, primarily those of the substantia nigra, and destructive lesions in the circuitry to the limbic system, motor system, and centers that regulate autonomic functions. Damaged neurons display neuronal cytoskeleton changes, including eosinophilic intraneuronal inclusion bodies (called Lewy bodies) and Lewy neurites in their neuronal processes.²³ Inclusion bodies contain compacted aggregates of presynaptic protein α -synuclein.²³ The course

of the disease is complicated by degeneration of other regions in the brain such as the cholinergic nucleus basalis, which can result in depression.^{23,24}

CLINICAL PRESENTATION

A major manifestation of Parkinson disease is resting tremor (that is attenuated during activity), muscle rigidity, slow movement (bradykinesia, shuffling gait), and facial impassiveness (mask of Parkinson disease)^{20,21,25} (Fig. 27.6). The tremor, which is rhythmic and fine and is best seen in the extremity at rest, produces a “pill-rolling rest tremor” and handwriting changes. Cogwheel-type rigidity (decreased arm swing with walking and foot dragging), stooped posture, unsteadiness, imbalance (gait instability), and falls also are common features. In addition, pain, (musculoskeletal, sensory [burning, numbness, tingling],^{20,21,25} or akathisia—subjective feeling of restlessness—restless leg syndrome), orthostatic hypotension, and bowel and bladder dysfunction occur in approximately 50% of patients.^{20,21,25}

Cognitive impairment of memory and concentration occurs to a variable degree, depending on the extent of destruction of the cortical–basal ganglia–thalamic neural loops. Mood disturbances (depression, dysthymia, apathy, anxiety), insomnia, and fatigue occur in approximately 40% of patients; dementia occurs in approximately 25%. Psychosis, related to dopaminergic medications, occurs in approximately 20% of patients.^{20,24,26}

Laboratory and Diagnostic Findings

Because no diagnostic test is available to detect Parkinson disease, the diagnosis requires a thorough history, clinical examination, and specific tests and imaging procedures to rule out diseases that can produce similar clinical manifestations, such as Wilson disease, arteriosclerotic pseudoparkinsonism, multiple stem atrophy, and progressive supranuclear palsy.²⁰

MEDICAL MANAGEMENT

Therapy is begun with the goal of increasing dopamine levels in the brain. Because no optimal drug treatment is available for Parkinson disease, each person is treated on an individual basis with a variety of drugs. The six classes of drugs used to manage the symptoms of Parkinson disease are shown in Table 27.1.^{20,25} Drug therapy generally is not initiated until lifestyle impairment such as slowness or imbalance occurs. Drug selection is based on anticipated adverse effects and complications, and therapy is initiated at the lowest effective dose.

The mainstay of treatment for advanced Parkinson disease is carbidopa–levodopa (Sinemet), an immediate precursor of the neurotransmitter dopamine. Use of this agent generally is reserved for later in the course of the disease because its activity wanes after about 5 to 10 years, and when given over the long term, it produces complicating adverse effects (dyskinesia—voluntary

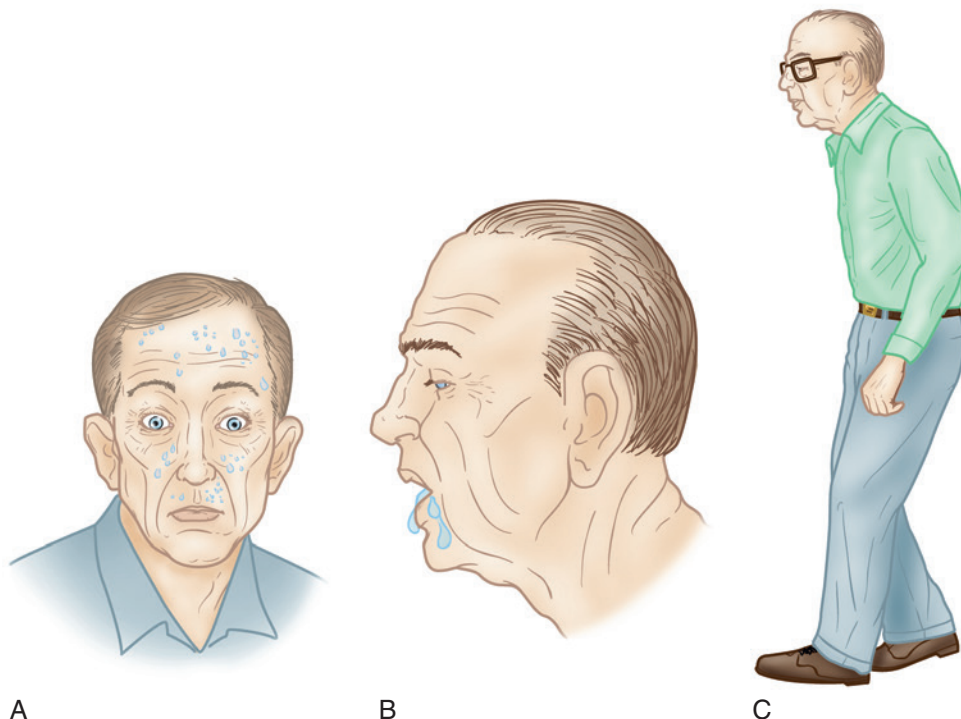

FIG 27.6 Characteristic features of Parkinson disease. **A**, Masklike appearance, stare, and excessive sweating. **B**, Drooling with excessive saliva. **C**, Parkinsonian gait with rapid, short, shuffling steps and reduced arm swinging. (From Seidel HM, Stewart RW, Ball JW: *Mosby's guide to physical examination*, ed 7, St. Louis, 2011, Mosby.)

rapid, flowing movements of limbs, trunk, or head). Management of progressive disease requires a careful balance between the beneficial effects of Sinemet or controlled-release levodopa (Sinemet CR) and the use of adjunctive medications such as (1) dopamine agonists and (2) catechol-*O*-methyltransferase (COMT) inhibitors (entacapone) used to diminish motor fluctuations, as well as (3) serotonin reuptake inhibitors used to manage depression and (4) acetylcholinesterase inhibitors given for dementia.²⁰ Dosage adjustments are required when dyskinesias, immobility, psychosis, or other adverse effects occur. Physical therapy is important for providing patients with safe methods for rising from a chair, walking around a room, navigating stairs, and combating immobility and contractures.²⁰

If symptoms progress despite drug therapy, surgery involving replacement of dopamine neurons by grafting of fetal nerve tissue is an alternative for patients with advanced Parkinson disease.²⁷ Other treatment modalities focus on halting neuronal loss with the use of antioxidants or introducing (injecting) trophic factors through lentiviral delivery of a gene that encodes glial cell line–derived neurotrophic factor. Deep brain stimulation of subthalamic nuclei, thalamotomy, or pallidotomy is reserved for patients with advanced disease and severe disabling or intractable tremor.^{20,28}

DENTAL MANAGEMENT

The dentist who treats adult patients can play an important role in recognizing the features of Parkinson disease and making a referral to a physician for thorough evaluation of persons who exhibit features of the disease. After the diagnosis has been made, concerns in dental management are twofold: (1) minimizing the adverse outcomes of muscle rigidity and tremor and (2) avoiding drug interactions (**Box 27.5**).²⁵

Because the muscular defect and tremor can contribute to poor oral hygiene, the dentist should assess the patient's ability to cleanse their dentition by demonstration. For patients unable to provide adequate home care, alternative solutions should be provided, such as the introduction of the Collis curve toothbrush, mechanical toothbrushes, assisted brushing, or chlorhexidine rinses.

Drug interactions of concern in dentistry are outlined in **Table 27.1**.²⁵ Although no adverse interactions have been reported between COMT inhibitors (tolcapone [Tasmar], entacapone [Comtan]) and epinephrine at dosages typically used in dentistry, they can potentially interact, and it is advisable to limit the dose of epinephrine to two carpules containing 1:100,000 epinephrine (36 µg) in patients who take COMT inhibitors. Erythromycin should not be given to patients who take the dopamine agonist

TABLE 27.1 Drugs Used in the Management of Parkinson Disease

Drug or Class	Reason Used	Adverse Effects	Dental Treatment Considerations
Anticholinergic	Blocks the effect of another brain neurotransmitter (acetylcholine) to rebalance its levels with dopamine		
Trihexyphenidyl HCl (Artane)		Sedation, urinary retention, constipation	Dry mouth
Benzotropine mesylate (Cogentin)			
Dopamine precursor	Provides a drug that is metabolized into dopamine (dopamine replacement)		
Levodopa			
Carbidopa-levodopa (Sinemet CR, Madopar CR)		Dyskinesia, fatigue, headache, anxiety, confusion, insomnia, orthostatic hypotension	If choreiform movements, dyskinesias, or tremors are present, sedation techniques may be required to perform dentistry; caution on getting up from the dental chair
Dopamine agonist	Mimics the action of dopamine		
Bromocriptine mesylate (Parlodel)*		Dopaminergic effects: psychosis (hallucinations, delusions), orthostatic hypotension, dyskinesia, nausea	Caution on getting up from the dental chair
Pramipexole (Mirapex)			Mirapex adversely interacts with erythromycin.
Ropinirole HCl (Requip)			
Catechol- <i>O</i> -methyltransferase (COMT) Inhibitor†	Used along with levodopa; this medication blocks the enzyme COMT to prevent levodopa breakdown in the intestine, thus allowing more of levodopa to reach the brain		
Tolcapone (Tasmar)*†		Potentiate levodopa effects: dyskinesia, psychosis, or orthostatic hypotension; nausea and diarrhea, abnormal taste	Caution with use of vasoconstrictors Monitor vital signs during and after administration of first capsule; limit dose to two capsules containing 1:100,000 epinephrine (36 µg) or less, depending on vital signs and patient response; aspirate to avoid intravascular injection.
Entacapone (Comtan)			
Monoamine oxidase B inhibitor†	Prevents metabolism of dopamine within the brain		
Selegiline†		Dizziness, orthostatic hypotension, nausea	Select adrenergic agents (i.e., amphetamine, pseudoephedrine, tyramine) may cause increased pressor response. However, this does not appear to occur with epinephrine or levonordefrin.
Neurotransmitter inhibitor	Has anticholinergic properties that enhance dopamine transmission		
Amantadine		Sedation, urinary retention, peripheral edema, nausea, constipation, confusion	

*May cause significant hepatic toxicity.

†Also has adverse vasoconstrictive properties.

BOX 27.5 Dental Management Considerations in Patients With Parkinson Disease**P****Patient Evaluation and Risk Assessment (See Box 1.1)**

- Evaluate to determine the nature, severity, control, and stability of disease.

Potential Issues and Factors of Concern

- Well-controlled Parkinson disease poses no specific management problems.

A

Analgesics	Clinicians should provide good pain control.
Antibiotics	There is no need for antibiotic prophylaxis.
Anesthesia	It is very important to obtain adequate anesthesia to reduce stress, which may worsen the movement disturbance. Epinephrine (1:100,000) in local anesthetics generally is well tolerated.
Anxiety	Patients with untreated or poorly controlled disease may experience exaggerated trembling and involuntary shaking movements and appear very anxious and stressed. Use of special anxiety and stress reduction techniques may be indicated.
Allergy	No issues

B

Bleeding	Generally, no bleeding problems are expected.
Blood pressure	Monitor blood pressure because dopamine may cause hypotension.

C

Chair position	This usually is not a problem if the patient is under good medical management; with symptoms of impending syncope, however, a supine position may not be tolerated. The patient taking dopamine may experience hypotension, warranting precautions with getting seated or on arising. The chair may need adjustment for adequate support to help reduce unnecessary movement or to stabilize the patient in a comfortable position.
----------------	---

Consultation	When the patient is under good medical management, the dental treatment plan is unaffected. However, consultation with the patient's physician to establish the level of control is recommended as part of the management program.
--------------	--

D

Devices	No issues
Drugs	These patients typically take anticholinergic and dopamine agonist drugs, which may have adverse effects, including sedation, drowsiness, slow mentation, fatigue, confusion, and dizziness (see Table 27.2).

E

Emergencies	Tremors most commonly are self-limited, but rarely the movement disturbance may be severe enough to interrupt dental treatment or to necessitate cessation of treatment.
-------------	--

Equipment	No issues
-----------	-----------

F

Follow-up	Routine follow-up is recommended.
-----------	-----------------------------------

pramipexole (Mirapex). The clinician should be aware that antiparkinsonian drugs can be central nervous system (CNS) depressants, and a dentally prescribed sedative may have an additive effect to those of such agents.²⁰

Orthostatic hypotension and rigidity are common in patients who have Parkinson disease. Orthostatic hypotension is an adverse effect associated with COMT inhibitors. To reduce the likelihood of a fall from the dental chair, the patient should be assisted to and from the chair. At the end of the appointment, the chair should be inclined slowly to allow for re-equilibration.^{20,25}

The treatment plan for the patient with Parkinson disease may require modification based on the patient's ability to cleanse the oral cavity. When communicating the treatment plan and other advice, the dentist should directly face the patient. This provides effective communication with a person who has the potential for cognitive impairment (see Box 27.5).

Patients should receive dental care during the time of day at which their medication has maximum effect (generally, 2–3 hours after taking it). The presence of tremors or choreiform movements may warrant use of soft arm restraints or sedation procedures.²⁵

Oral Complications and Manifestations

Parkinson disease is associated with staring, excess salivation and drooling, and decreased frequency of blinking and swallowing.^{21,25} Muscle rigidity makes repetitive muscle movement and maintenance of good oral hygiene difficult. By contrast, the drugs used to manage the disease (anticholinergics, dopaminergics, amantadine, and L-dopa) often result in xerostomia, nausea, and tardive dyskinesia.^{21,25} Dental recall visits should be more frequent for this population, and specific measures (specialized toothbrushes, e.g., Collis curve toothbrush, mechanical brushes) should be devised to maintain adequate oral

hygiene. If the patient is experiencing xerostomia, dysphagia and poor denture retention are likely to result. Salivary substitutes are beneficial in alleviating symptoms. Topical fluoride should be considered for use in dentate patients with xerostomia to prevent root caries. Personal care providers should be educated about their role in assisting and maintaining the oral hygiene of these patients.^{21,25}

DEMENTIA AND ALZHEIMER DISEASE

GENERAL DESCRIPTION

Dementia is a syndrome, usually of a chronic and progressive nature in which there is deterioration of cognitive function. This disorder impairs the individual's ability to process thought which consequently interferes with daily functions and results in a loss of independence.^{29,30} Dementia consists of a slow, progressive, chronic decline in intellectual abilities that includes impairment in memory, abstract thinking, and judgment. It is primarily a disease of aging; 1% of cases appear by age 60 years, and more than 40% of cases occur by age 85 years. Overall, the course of dementia is chronic in 65% of cases, partially treatable in 25% of cases, and reversible in only 10% of cases.^{29,30} The most common causes of dementia are Alzheimer disease, vascular dementia, and dementia caused by Parkinson disease. Other causes include hepatic encephalopathy, acid-base and electrolyte disturbances, hypoglycemia, head trauma, thyroid disease (involving either low or high levels of hormone), uremia, primary or metastatic brain lesions, acquired immunodeficiency syndrome (AIDS), trauma, syphilis, MS, stroke, and drugs. A small subset of dementias, such as Creutzfeldt-Jakob disease, may have a very rapid onset with a clinical course of less than 1 year.^{29,30}

Because of its relatively high prevalence, Alzheimer disease serves as the prototype for discussion of dementia in this chapter. This disease, which was first described by Alois Alzheimer in 1907, predominantly affects older adults. However, the process may occur in younger adults as well.²⁹

EPIDEMIOLOGY

The prevalence of dementia increases with age, and the population is aging. Worldwide there are nearly 50 million cases of dementia with approximately 8 million new cases each year.^{30,31} Among persons older than 65 years of age, the prevalence is about 7%. From age 70 years on, the prevalence doubles every 5 years. By age 85 years, more than 40% of persons will have developed Alzheimer disease. With the aging of the population in the United States, the prevalence of this disease is predicted to double by 2020.^{29,31} Approximately 8 million people in the United States experience dementia, and approximately 70% of these cases are of the Alzheimer type. Women are at

greater risk (3:2 female-to-male ratio) for developing the disease; therefore, almost 70% of all patients with Alzheimer disease are women, primarily because women live longer than men. Older African Americans and Hispanics are more likely than older whites to have Alzheimer and other dementias.²⁹⁻³¹ An average dental practice of 2000 adult patients is predicted to include about 20 patients who experience Alzheimer disease.²⁹⁻³¹

Pathophysiology and Complications

The cause of Alzheimer disease is unknown but appears to involve the loss of cholinergic neurons. Unidentified factors trigger the deposition of beta-amyloid plaques that initiate an inflammatory response, oxidative damage, progressive neuritic injury, and loss of cortical neurons. As a result, levels of neurotransmitters important for learning and memory decrease. Genetic predisposition contributes to fewer than 20% of all cases. In these cases, the disease appears to be inherited by way of the apolipoprotein E4 (ApoE4) allele located on chromosome 19. Three other chromosomes have been implicated to a lesser degree in the transmission of Alzheimer disease—an amyloid precursor gene on chromosome 21, a presenilin-1 gene on chromosome 14, and a presenilin-2 gene on chromosome 1.²⁹ Inasmuch as chromosome 21 contains a gene that expresses a cleavage product of the amyloid precursor protein, it is not surprising that adults with trisomy 21 (Down syndrome) consistently develop neuropathologic hallmarks of Alzheimer disease if they survive beyond the age of 40 years. Risk factors for Alzheimer disease comprise age, family history of dementia, and the presence of both ApoE4 alleles.^{29,32-34}

Alzheimer disease is characterized by beta-amyloid plaques and neuroinflammation that results in neurofibrillary tangles and loss of cortical neurons.²⁹ The process begins in the hippocampus and the entorhinal cortex. Over time, it spreads to specific regions of the brain (temporal, parietal, and frontal lobes) that are important for learning and memory. Affected neurons make up part of the cholinergic system and use acetylcholine and glutamate as their primary neurotransmitters. These neurotransmitters are intimately involved in cognition. Progressive destruction of the neurons leads to atrophy of the cerebral cortex and enlargement of the ventricles. Motor, visual, and somatosensory portions of the cerebral cortex typically are spared. Resultant cognitive defects and associated memory loss cause significant impairment in social and occupational functioning.²⁹

CLINICAL PRESENTATION

The onset of Alzheimer disease occurs subtly and insidiously; the first sign is loss of recent memory, orientation, or language or a change in personality (apathy) or behavior. Slowly, cognitive problems at the early stage begin to interfere with daily activities such as keeping track of finances, following instructions on the job, driving,

TABLE 27.2 Signs and Symptoms of Dementia by Stage

Dementia affects each person in a different way, depending upon the impact of the disease and the person's personality before becoming ill. The signs and symptoms linked to dementia can be understood in three stages.

Early stage: The early stage of dementia is often overlooked because the onset is gradual. Common symptoms include:

- Forgetfulness
- Losing track of the time
- Becoming lost in familiar places

Middle stage: As dementia progresses to the middle stage, the signs and symptoms become clearer and more restricting. These include:

- Becoming forgetful of recent events and people's names
- Becoming lost at home
- Having increasing difficulty with communication
- Needing help with personal care
- Experiencing behavior changes, including wandering and repeated questioning

Late stage: The late stage of dementia is one of near total dependence and inactivity. Memory disturbances are serious, and the physical signs and symptoms become more obvious. Symptoms include:

- Becoming unaware of the time and place
- Having difficulty recognizing relatives and friends
- Having an increasing need for assisted self-care
- Having difficulty walking
- Experiencing behavior changes that may escalate and include aggression

shopping, and housekeeping.²⁹ The signs and symptoms of dementia can be seen in [Table 27.2](#).²⁹⁻³¹ Some patients remain unaware of these developing problems; others are aware of them and become frustrated and anxious. At the middle stage of the disease, the patient is unable to work, is easily lost and confused, and requires daily supervision. Patients may become lost while taking walks or driving. Social graces, routine conversation, and superficial conversation may be maintained for variable periods. Language may be impaired, especially comprehension and naming of objects. Motor skills such as eating, dressing, or solving simple puzzles are eventually lost. Patients are unable to do simple calculations or to tell time. Loss of inhibitions and belligerence may occur, and nighttime wandering may become a problem with some patients. Anxiety and depression become more of a problem as the disease progresses.²⁹ At the advanced stage of Alzheimer disease, patients may become rigid, mute, incontinent, and bedridden, often requiring a nursing facility. Generalized seizures may occur. Death usually results from malnutrition, secondary infection, or heart disease. The typical duration of Alzheimer disease is 5 to 15 years. However, the course of the illness can range from 1 to 20 years. Some patients exhibit a steady downhill course; others may have prolonged plateaus without major deterioration.²⁹

Laboratory and Diagnostic Findings

Although the definitive diagnosis of Alzheimer can be made only by brain biopsy or at autopsy, the clinical diagnosis of Alzheimer disease can be made on the basis of patient history and clinical findings.²⁹ Criteria for making this diagnosis include (1) progressive functional decline and dementia established by clinical examination and mental status testing, (2) the presence of at least two cognitive deficits, (3) normal level of consciousness at presentation, (4) onset between the ages of 40 and 90 years, and (5) absence of any other condition that could account for the deficits. The battery of tests useful in ruling out other correctable causes of dementia include a complete blood count, electrolyte panel, screening metabolic panel, thyroid function tests, determination of vitamin B₁₂ and folate levels, tests for syphilis and human immunodeficiency virus (HIV) antibodies, urinalysis, ECG, chest radiograph, and noncontrast CT scan or MRI of the brain.²⁹

At autopsy, characteristic macroscopic changes include cerebral cortical atrophy and ventricular enlargement. Microscopic features include neurofibrillary tangles, neuritic plaques that contain beta-amyloid, and accumulation of beta-amyloid in the walls of cerebral vessels (amyloid angiopathy). On a biochemical level, a deficiency of acetylcholine and its associated enzymes has been confirmed.²⁹⁻³⁴

The Alzheimer Association and the National Institutes of Health/National Institute on Aging have developed new criteria for categories of Alzheimer disease.^{31,35} These criteria divide the disease into three stages: preclinical Alzheimer disease, marked by no outward symptoms and only measurable changes in biomarkers such as spinal fluid chemistry; mild cognitive impairment, in which changes in memory and thinking appear but do not yet compromise everyday activities and functioning; and dementia, the defining trait of late-stage disease. The previous criteria offer no way to diagnose Alzheimer disease in a preclinical state because appropriate biomarkers are still being investigated and standardized, which means that “preclinical Alzheimer disease” remains mainly for future studies to define.

However, the publication of these new criteria makes it official that the middle stage, measurable mild cognitive impairment, can be considered part of the disease spectrum for Alzheimer disease. In other words, Alzheimer disease can now be defined by subtle brain changes rather than exclusively by dementia.^{31,35}

MEDICAL MANAGEMENT

There is no cure for Alzheimer disease, and management remains difficult. Standard medications used in the treatment of mild to moderate disease have been the cholinesterase inhibitors. These drugs—donepezil (Aricept), rivastigmine (Exelon), memantine (Namenda), galantamine

(Razadyne, Reminyl), and tacrine (Cognex)—increase acetylcholine levels in the brain by inhibiting hydrolysis of cholinesterase (Table 27.3).^{29,31-38} Clinical trials indicate that these agents perform better than placebo but have limited effectiveness in preventing disease progression and in reversing memory deficits. Fewer than 50% of patients appear to benefit from these medications.^{29,31-38} Common adverse effects of the cholinesterase inhibitors include gastrointestinal disturbance and headache. Tacrine, the first of the cholinesterase inhibitors to be marketed, is infrequently prescribed today because it requires frequent dosing and can be hepatotoxic.^{29,31-38}

To slow the progression of disease, the American Academy of Neurology recommends that vitamin E be considered as an additional medication.³⁷⁻³⁹ Studies have shown that vitamin E and selegiline (two antioxidants) each can delay the development of dementia in patients with Alzheimer disease.²⁹⁻³¹

For the management of moderate to severe Alzheimer disease, memantine (Axura), an *N*-methyl-D-aspartate (NMDA) receptor antagonist, has been approved by the U.S. FDA.^{37,38} This drug works by selectively blocking

the excitotoxic effects of abnormal glutamate transmission. Initial studies suggest that it may preserve or improve memory and learning and, when given with the cholinesterase inhibitors, appears to produce additive beneficial effects. Memantine-related adverse effects are mild and include headache and confusion.^{37,38}

Noncognitive symptoms of Alzheimer disease are manageable. Although efforts are made to use nonpharmacologic approaches to manage symptoms such as anxiety, depression, irritability, and sleep disturbances, medications inevitably are generally required. Antidepressants, sedative-hypnotics, and antipsychiatric agents all are used, with varying degrees of success. A small percentage of patients experience seizures, which are treated with standard anticonvulsant agents. Nursing home care often is provided during the latter stages of the disease.³⁶⁻⁴⁰

DENTAL MANAGEMENT

Dental management requires knowledge of the stage of disease, medications taken, and the cognitive abilities of the patient (Box 27.6). Patients with mild to moderate

BOX 27.6 Dental Management Considerations in Patients With Alzheimer Disease or Other Dementias

P Patient Evaluation and Risk Assessment (See Box 1.1)

- Evaluate to determine the nature, severity, control, and stability of disease.

Potential Issues and Factors of Concern

- Well-controlled Alzheimer disease or dementia poses no specific management problems.

A

Analgesics	Clinicians should provide good pain control.
Antibiotics	There is no need for antibiotic prophylaxis.
Anesthesia	Local anesthesia obtained with epinephrine (1:100,000) in local anesthetics generally is not associated with any problems.
Anxiety	Patients with untreated or poorly controlled disease may experience difficulty in understanding commands or instructions and appear very anxious or stressed. Use of special anxiety or stress reduction techniques may be indicated.
Allergy	No issues

B

Bleeding	Generally, no bleeding problems are expected.
Blood pressure	Monitor blood pressure because some medications may cause hypotension.

C

Chair position	This usually is not a problem if the patient is under good medical management: With symptoms of impending syncope, however, a supine position may not be tolerated. The chair may need adjustment to address patients' concerns or fears.
----------------	---

Consultation	Once the patient is under good medical management, the dental treatment plan is unaffected. However, consultation with the patient's physician to establish the level of control is recommended as part of the management program.
--------------	--

D

Devices	No issues
Drugs	These patients typically take anticholinergic drugs, which may have adverse effects including sedation, drowsiness, slow mentation, fatigue, confusion, and dizziness (see Table 27.3).

E

Emergencies	Most commonly, cognitive problems are self-limited, but rarely the patient's condition may progress acutely to warrant interruption of dental treatment or to necessitate cessation of treatment.
-------------	---

Equipment	No issues
-----------	-----------

F

Follow-up	In patients who have undergone surgery or other complex dental procedures, a follow-up call within the next day or two is advisable to check on clinical status.
-----------	--

TABLE 27.3 Drugs Used in the Management of Alzheimer Disease

Drug	Drug Type and Use & How It Works	Common Side Effects	For More Information
Memantine (Namenda)	NMDA antagonist prescribed to treat symptoms of moderate to severe Alzheimer disease Blocks the toxic effects associated with excess glutamate and regulates glutamate activation	Dizziness, headache, constipation, confusion	For current information about this drug's safety and use, visit http://www.namenda.com . Click on "Prescribing Information" to see the drug label.
Galantamine (Razadyne)	Cholinesterase inhibitor prescribed to treat symptoms of mild to moderate Alzheimer disease Prevents the breakdown of acetylcholine and stimulates nicotinic receptors to release more acetylcholine in the brain	Nausea, vomiting, diarrhea, weight loss, loss of appetite	For current information about this drug's safety and use, visit http://www.razadyne.com . Click on "Important Safety Information" to see links to prescribing information.
Rivastigmine (Exelon)	Cholinesterase inhibitor prescribed to treat symptoms of mild to moderate Alzheimer disease Prevents the breakdown of acetylcholine and butyrylcholine (a brain chemical similar to acetylcholine) in the brain	Nausea, vomiting, diarrhea, weight loss, loss of appetite, muscle weakness	For current information about this drug's safety and use, visit http://www.fda.gov/cder . Click on "Drugs@FDA," search for Exelon, and click on drug name links to see "Label Information."
Donepezil (Aricept)	Cholinesterase inhibitor prescribed to treat symptoms of mild to moderate, and moderate to severe Alzheimer disease Prevents the breakdown of acetylcholine in the brain	Nausea, vomiting, diarrhea	For current information about this drug's safety and use, visit http://www.fda.gov/cder . Click on "Drugs@FDA," search for Aricept, and click on drug name links to see "Label Information."

Manufacturer's Recommended Dosage:

Tablet: Initial dose of 5 mg once a day

May increase dose to 10 mg/day (5 mg twice a day), 15 mg/day (5 mg and 10 mg as separate doses), and 20 mg/day (10 mg twice a day) at minimum 1-week intervals if well tolerated

Oral solution: same dosage as above

Extended-release tablet: Initial dose of 7 mg once a day; may increase dose to 14 mg/day, 21 mg/day, and 28 mg/day at minimum 1-week intervals if well tolerated.

Tablet*: Initial dose of 8 mg/day (4 mg twice a day)

May increase dose to 16 mg/day (8 mg twice a day) and 24 mg/day (12 mg twice a day) at minimum 4-week intervals if well tolerated

Oral solution*: Same dosage as above

Extended-release capsule*: Same dosage as above but taken once a day

Capsule*: Initial dose of 3 mg/day (1.5 mg twice a day)

May increase dose to 6 mg/day (3 mg twice a day), 9 mg (4.5 mg twice a day), and 12 mg/day (6 mg twice a day) at minimum 2-week intervals if well tolerated

Patch: Initial dose of 4.6 mg once a day; may increase to 9.5 mg once a day after minimum of 4 weeks if well tolerated

Oral solution: Same dosage as for capsule

Tablet*: Initial dose of 5 mg once a day

May increase dose to 10 mg/day after 4–6 weeks if well tolerated and then to 23 mg/day after at least 3 months

Orally disintegrating tablet*: Same dosage as for regular tablet; 23-mg dose available as brand-name tablet only

*Available as a generic drug.

NMDA, N-methyl-D-aspartate.

From the Alzheimer's Disease Education and Referral (ADEAR) Center, a Service of the National Institute on Aging: *Alzheimer's disease medications fact sheet*, NIH Publication No. 08-3431 (updated December 2010), Bethesda, MD, National Institutes of Health, U.S. Department of Health and Human Services, 2008.

disease generally maintain normal systemic organ function and can receive routine dental treatment. As the disease progresses, antipsychotics, antidepressants, and anxiolytics frequently are used to manage behavioral disturbances. These medications, however, contribute to xerostomia with increased risk for dental caries.³⁶

There is no cure for Alzheimer disease. However, several prescription drugs are currently approved by the FDA (see Table 27.3) for use in people diagnosed with this condition. Treating the symptoms of Alzheimer disease can maximize the comfort, dignity, and independence of these patients for a longer period of time, thereby providing

support and assistance for their caregivers as well.^{29,38} It is important to recognize that none of these medications stops the disease itself.

Several cholinesterase inhibitors are prescribed for mild to moderate Alzheimer disease. These drugs may help delay or prevent symptoms from becoming worse for a limited time and may help control some behavioral symptoms. The medications include galantamine (Razadyne), rivastigmine (Exelon), and donepezil (Aricept). Another drug, tacrine (Cognex), was the first approved cholinesterase inhibitor but is rarely prescribed today owing to safety concerns.^{29,38} No one

fully understands how cholinesterase inhibitors work to treat Alzheimer disease, but research indicates that these agents prevent the breakdown of acetylcholine, believed to be important for memory and thinking. As Alzheimer progresses, the brain produces less and less acetylcholine; therefore, cholinesterase inhibitors may eventually lose their effect.^{29,38}

Another medication, memantine (Namenda), an NMDA antagonist, is prescribed to treat moderate to severe Alzheimer disease (see [Table 27.3](#)). This drug's main effect is to delay progression of some of the symptoms of moderate to severe disease. It may allow patients to maintain certain daily functions a little longer than they would without the medication. For example, memantine may help a patient in the later stages of the disease maintain the ability to use the bathroom independently for several more months, a benefit for both patients and caregivers.^{29,38}

Memantine is believed to work by regulating glutamate, an important brain chemical. When produced in excessive amounts, glutamate may lead to brain cell death. Because NMDA antagonists work very differently from cholinesterase inhibitors, the two types of drugs can be prescribed in combination.^{29,38}

The FDA also has approved donepezil for the treatment of moderate to severe Alzheimer disease.^{29,38} Patients usually are started at low drug doses, with gradual increases in dosage based on how well the drug is tolerated. Some evidence suggests that certain patients may benefit from higher doses of the cholinesterase inhibitors. However, the higher the dose, the more likely are side effects.^{29,38}

The recommended effective dosages of drugs prescribed to treat the symptoms of Alzheimer disease, along with possible side effects, are summarized in [Table 27.3](#).

Patients should be monitored when a drug is started. Any unusual symptoms should be reported right away to the prescribing doctor. It is important to follow the physician's instructions for taking any medication, including vitamins and herbal supplements. Also, any additions to or changes in medications should be cleared beforehand with the patient's physician.^{29,38}

To learn more, patients can be advised to talk with their doctor or to visit the Alzheimer Disease Education and Referral (ADEAR) Center's listing of clinical trials on the National Institute on Aging's website (<http://www.nia.nih.gov/Alzheimers/ResearchInformation/ClinicalTrials>).

Patients with Alzheimer disease are best managed with use of an understanding and empathetic approach. The dental team should communicate a positive, hopeful attitude regarding maintenance of the patient's oral health to both the patient and family members (see [Box 27.6](#)). The dental team should determine whether the patient is legally able to make rational decisions. This issue should be discussed with the patient and family.³⁶ Treatment planning often involves input and permission from a family

member so that appropriate decisions can be made. Before initiation of any procedure, the patient's attention should be engaged, and the dentist should explain what is going to happen.³⁶ The dentist should communicate using short words and sentences and should repeat instructions and explanations. Nonverbal communication can be very helpful. Facial motion and body posture of the dentist should show support—cues that the patient is understood and that the dentist is attentive to the patient's well-being. Positive nonverbal communication includes direct eye contact, smiling, touching the patient on the arm, and so forth. Patients with Alzheimer disease should be placed on an aggressive preventive dentistry program, including 3-month recall, oral examination, prophylaxis, fluoride gel application, oral hygiene education, and adjustment of prostheses.^{36,39}

In a patient with mild dementia, good oral health should be quickly restored because of the progressive nature of the disease. Subsequent care should concentrate on preventing dental disease as dementia progresses. A patient with moderate dementia may not be as amenable to dental treatment as in earlier stages of the disease. In such cases, treatment consists of maintaining dental status and minimizing deterioration. Complex dental procedures should be performed, if at all, before the disease has reached the moderate to advanced stage.^{36,39}

Patients with advanced dementia often are anxious, hostile, and uncooperative in the dental office and very difficult to treat. These patients are best served with short appointments and noncomplex procedures; use of sedation may be required for more complex and tedious procedures. Sedative medication should be selected in consultation with the patient's physician. Chloral hydrate and benzodiazepines can be used to provide the level of sedation required for performance of routine dental procedures.^{36,39}

In advanced cases, removable prosthetic devices may have to be taken from the patient because of the danger of self-injury. All treatment should be provided with the knowledge that these patients have memory loss, lack of drive, and slowed thinking. Thus, their ability to maintain proper daily oral hygiene can become severely compromised.

Oral Complications and Manifestations

Patients with moderate to severe Alzheimer disease may not have an interest in caring for themselves, and they may lack the ability to do so. Hence, their oral hygiene is poor, and dental problems are increased. Most of the medications used to treat psychiatric disorders contribute to increased dental problems in such patients because xerostomia is one of their primary adverse effects. Patients with Alzheimer disease have a greater incidence of dry mouth, mucosal lesions, candidiasis, plaque and calculus buildup, periodontal disease, and smooth surface (root) and coronal caries, along with an increased risk for aspiration pneumonia.^{36,39}

These patients often sustain oral injuries from falls and ulcerations of the tongue, cheeks, and alveolar mucosa as the result of accidents with forks or spoons or with mastication, attrition and abrasion of teeth, missing teeth, and migration of teeth. Edentulous patients with dementia may misplace or lose their dentures and at times may even attempt to wear the upper denture on the lower arch and vice versa.^{36,39}

Antipsychotic drugs sometimes taken by these patients can cause agranulocytosis, leukopenia, or thrombocytopenia. Additional adverse effects of antipsychotic agents include muscular problems such as dystonia, dyskinesia, and tardive dyskinesia in the oral and facial regions.³⁶⁻⁴⁰

EPILEPSY

GENERAL DESCRIPTION

The term *epilepsy* includes disorders or syndromes with widely variable pathophysiologic findings, clinical manifestations, treatments, and outcomes.⁴¹ Epilepsy is not a specific diagnosis but rather a term that refers to a group of disorders characterized by chronic and recurrent, paroxysmal changes in neurologic function (seizures), altered consciousness, or involuntary movements caused by abnormal and spontaneous electrical activity in the brain. Seizures may be convulsive (i.e., accompanied by motor manifestations) or may occur with other changes in neurologic function (i.e., sensory, cognitive, and emotional).⁴¹

Seizures are characterized by discrete episodes, which tend to be recurrent and often are unprovoked, in which movement, sensation, behavior, perception, and consciousness are disturbed. Symptoms are produced by excessive temporary neuronal discharging, which may result from intracranial or extracranial causes.⁴¹

Although seizures are required for the diagnosis of epilepsy, not all seizures imply presence of epilepsy. Seizures may occur during many medical or neurologic illnesses, including stress, sleep deprivation, fever, alcohol or drug withdrawal, and syncope.¹ A list of epilepsy syndromes and the currently accepted classification of seizure types are presented in **Box 27.7**. This seizure classification, based on clinical behaviors and electroencephalographic changes, consists of two major groups: partial and generalized. *Partial* seizures are limited in scope (to a part of the cerebral hemisphere) and clinical manifestations and involve motor, sensory, autonomic, or psychic abnormalities.⁴¹ Partial seizures are subdivided into *simple*, in which consciousness is preserved, and *complex*, in which consciousness is impaired. *Generalized* seizures are more global in scope and manifestations. They begin diffusely, involve both cerebral hemispheres, are associated with alteration in consciousness, and frequently produce abnormal motor activity.⁴¹ Discussion in this section is limited to generalized tonic-clonic seizures (idiopathic grand mal) because these represent the most severe expression of epilepsy that dentists are likely to encounter.

BOX 27.7 Classification of Epileptic Syndromes and Seizure Types

Epileptic Syndromes

Primary or Idiopathic

Localization Related

Benign epilepsy with centrotemporal spikes
Autosomal dominant nocturnal frontal lobe epilepsy

Generalized

Juvenile myoclonic epilepsy
Juvenile absence epilepsy
Severe myoclonic epilepsy of infancy
Progressive myoclonic epilepsies
Generalized epilepsy with febrile seizures

Secondary or Symptomatic

Localization Related

Mesial temporal lobe epilepsy
Neoplasm (primary, metastatic)
Infection (abscess, encephalitis, meningitis, syphilis, cysticercosis, Lyme disease, tuberculosis, fungal disease, herpes)
Vascular (stroke, transient ischemic attack, migraine, hemorrhage)
Developmental (migrational)
Perinatal
Traumatic
Degenerative (e.g., Alzheimer disease)
Immunologic (e.g., multiple sclerosis)

Generalized

West's syndrome
Lennox-Gastaut syndrome
Tuberous sclerosis
Sturge-Weber syndrome

Seizure Types*

I. Partial (Focal, Local)

- Simple partial seizures
- Complex partial seizures
- Partial seizures evolving to secondarily generalized seizures

II. Generalized (Convulsive or Nonconvulsive)

- Absence seizures (petit mal)
- Myoclonic seizures
- Tonic-clonic seizures (grand mal)
- Tonic seizures
- Atonic seizures

III. Unclassified Epileptic Seizures

*International classification of epileptic syndromes (condensed). Data from Commission on Classification and Terminology of the International League Against Epilepsy. Proposal for revised clinical and electroencephalographic classification of epileptic seizures, *Epilepsia* 22:489-501, 1981.

EPIDEMIOLOGY

Epilepsy, which is the most common chronic neurologic condition, affects people of all ages, with a peak incidence in childhood and old age.⁴² In the United States, the incidence of all types of epilepsy is approximately 48

cases per 100,000 population with approximately 150,000 cases per year. Cases of epilepsy vary by age: 60 to 70 per 100,000 per year in young children (younger than 5 years of age), 45 per 100,000 in adolescents, and as low as 30 per 100,000 in the early adult years but rising through the sixth and seventh decades of life back to 60 to 70 per 100,000 and reaching as high as 150 to 200 per 100,000 in persons older than 75 years.⁴² The incidence in males is higher at every age. Estimates of the prevalence of epilepsy range from 4.7 to 6.9 per 1000, but its prevalence is much higher in less developed countries for all age groups.⁴²

Approximately 10% of the population will have at least one epileptic seizure in their lifetimes, and 2% to 4% will experience recurrent seizures at some point.^{41,42} The overall incidence of seizures is 0.5%.^{41,42} Seizures are most common during childhood, with as many as 4% of children experiencing at least one seizure during the first 15 years of life. Most children outgrow the disorder. About 4 in 1000 children do not outgrow the disorder and will require medical care. Seizures also are common in old age, with an estimated annual incidence of 134 per 100,000. In a typical dental practice of 2000 patients, 3 or 4 can be expected to have a seizure disorder.^{41,42} Cerebrovascular disease is the most common factor underlying seizures occurring in older adults.^{41,42}

Pathophysiology and Complications

Epileptic seizures are idiopathic in more than half of all affected patients.^{41,42} Vascular (cerebrovascular disease) and developmental abnormalities (cavernous malformation), intracranial neoplasms (gliomas), and head trauma are causative in about 35% of adult cases. Other common causes include hypoglycemia, drug withdrawal, infection, and febrile illness (e.g., meningitis, encephalitis). Seizures occur with genetic conditions such as Down syndrome, tuberous sclerosis, and neurofibromatosis and are associated with several genetic abnormalities that result in neuronal channel dysfunction.^{41,42}

Seizures sometimes can be evoked by specific stimuli. Approximately 1 of 15 patients reports that seizures occurred after exposure to flickering lights, monotonous sounds, music, or a loud noise.⁴¹ Syncope and diminished oxygen supply to the brain also are known to trigger seizures. It is valuable for the dentist to know what factors have the potential to exacerbate a seizure in a particular patient, so that certain stimuli can be avoided.⁴³

The basic event underlying an epileptic seizure is an excessive focal neuronal discharge that spreads to thalamic and brainstem nuclei. The cause of this abnormal electrical activity is not precisely known, although a number of theories have been put forth.⁴¹ These include altered sodium channel function, altered neuronal membrane potentials, altered synaptic transmission, diminution of inhibitory neurons, increased neuronal excitability, and decreased electrical threshold for epileptic activity. During

the seizure, blood becomes hypoxic, with consequent development of lactic acidosis.⁴¹

Approximately 60% to 80% of patients with epilepsy achieve complete control over their seizures within 5 years; the remainder achieve only partial or poor control.^{41,43,44} A significant problem in the medical management of epileptic patients is one of compliance (i.e., adherence to prescribed treatment regimens including medication). This problem is common to many chronic disorders, such as hypertension, because patients may have to take medication for the rest of their lives even though they remain asymptomatic. Evidence suggests that patients who have epilepsy from an early age have a higher incidence of future complications and die at an earlier age. Noncompliance may be a clinically important consideration in dental patients because it is associated with a higher risk of later complications that may lead to death.^{41,43,44} Complications of seizures include trauma (as a result of falls) to the head, neck, and mouth and aspiration pneumonia. Also, frequent and severe seizures are associated with altered mental function, dullness, confusion, argumentativeness, and increased risk of sudden death (about 1 in 75 persons in this group die annually).^{41,43,44}

A serious acute complication of epilepsy (especially the tonic-clonic type) is the occurrence of repeated seizures over a short time without a recovery period, called *status epilepticus*. This condition most frequently is caused by abrupt withdrawal of anticonvulsant medication or an abused substance but may be triggered by infection, neoplasm, or trauma. Status epilepticus constitutes a medical emergency.^{41,43,44} Patients may become seriously hypoxic and acidotic during this event and sustain permanent brain damage or death. Patients with epilepsy also are at increased risk for sudden death and death due to accident.^{41,43,44}

CLINICAL PRESENTATION

The clinical manifestations of generalized tonic-clonic convulsions (grand mal seizures) are classic. An aura (a momentary sensory alteration that produces an unusual smell or visual disturbance) precedes the convulsion in one third of patients. Irritability is another premonitory signal. After the aura warning, the patient emits a sudden “epileptic cry” (caused by spasm of the diaphragmatic muscles) and immediately loses consciousness. The tonic phase consists of generalized muscle rigidity, pupil dilation, rolling of the eyes upward or to the side, and loss of consciousness. Breathing may stop because of spasm of respiratory muscles.^{41,43,44} This phase is followed by clonic activity consisting of uncoordinated beating movements of the limbs and head, forcible jaw closing, and up and down head rocking.^{41,43,44} Urinary incontinence is common, but fecal incontinence is rare. The seizure (ictus) usually does not last longer than 90 seconds; thereafter, movement ceases and muscles relax, with a gradual return to consciousness, accompanied by stupor, headache, confusion,

and mental dulling. Several hours of rest or sleep may be needed for the patient to regain full cognitive and physical abilities.^{41,43,44}

Laboratory and Diagnostic Findings

The diagnosis of epilepsy generally is based on the history of seizures and presence of abnormalities on the electroencephalogram (EEG).^{41,43,44} Seizures produce characteristic spike and sharp wave patterns on the EEG tracing. Serial recordings during sleep deprivation, which can induce seizures, may help to establish the diagnosis. Other diagnostic procedures that are useful for ruling out other causes of seizures include CT, MRI, single-photon emission computed tomography (SPECT), lumbar puncture, serum chemistry profiles, and toxicology screening.^{41,43,44}

MEDICAL MANAGEMENT

The medical management of epilepsy usually is based on long-term drug therapy. Phenytoin (Dilantin), carbamazepine (Tegretol), and valproic acid are considered first-line agents for treatment of this disease. Several other drugs are available for control of generalized tonic-clonic seizures^{41,44,46} (Table 27.4). These drugs reduce the frequency of seizures by elevating the seizure threshold of motor cortex neurons, depressing abnormal cerebral electrical discharge, and limiting the spread of excitation from abnormal foci. Phenytoin and carbamazepine are efficient at blocking sodium or calcium channels of motor neurons.^{41,44,46} Many of the other antiepileptic drugs augment γ -aminobutyric acid (GABA), which inhibits glutamate activity—the major determinant of

TABLE 27.4 Anticonvulsants Used in the Management of Generalized Tonic-Clonic (Grand Mal) Seizures

Drug	Trade Name(s)	Mechanism of Action	Dental Treatment Considerations
DRUGS OF CHOICE			
Phenytoin*	Dilantin	Blocks sodium channels	Gingival hyperplasia, increased incidence of microbial infection, delayed healing, gingival bleeding (leukopenia), osteoporosis, Stevens-Johnson syndrome
Carbamazepine*	Tegretol	Blocks sodium channels	Xerostomia, microbial infection, delayed healing, gingival bleeding (leukopenia and thrombocytopenia), ataxia, osteoporosis, Stevens-Johnson syndrome <i>Drug interactions:</i> propoxyphene, erythromycin
Valproic acid*	Depakene, Depakote	GABA augmentation and NMDA receptor	Excessive bleeding and petechiae, decreased platelet aggregation, increased incidence of microbial infection, delayed healing, drowsiness, gingival bleeding (leukopenia and thrombocytopenia), hepatotoxicity <i>Drug interactions:</i> aspirin and other NSAIDs
Lamotrigine*	Lamictal	Blocks sodium and calcium channels, reduces glutamate	Ataxia; may require help getting into and out of the dental chair; risk for development of Stevens-Johnson syndrome
ALTERNATIVES			
Clonazepam*	Klonopin	Augments inhibitory GABAergic system	<i>Drug interactions:</i> CNS depressants
Ethosuximide	Zarontin	Blocks sodium and calcium channels	Risk for development of Stevens-Johnson syndrome, blood dyscrasias
Felbamate	Felbatol	Blocks sodium channels, reduces glutamate	Risk for development of aplastic anemia, Stevens-Johnson syndrome
Gabapentin	Neurontin	Modulates calcium channel; augments GABAergic system	Dizziness
Oxcarbazepine	Trileptal	Blocks sodium channels	Liver enzyme induction but less than with carbamazepine
Phenobarbital*	Luminal	Blocks calcium channel; augments inhibitory GABAergic system	Sedation, liver enzyme induction <i>Drug interactions:</i> CNS depressants
Primidone*	Mysoline	Blocks calcium channel; augments inhibitory GABAergic system	Ataxia, vertigo—increased risk of falls
Topiramate	Topamax	Blocks sodium channels; augments inhibitory GABAergic system	Impaired cognition
Vigabatrin	Sabril	Augments inhibitory GABAergic system	<i>Drug interactions:</i> CNS depressants

*Preexisting liver disease can exacerbate adverse effects associated with antiepileptics. Drugs of choice for absence (petit mal) seizures: ethosuximide (Zarontin), valproate, lamotrigine, or clonazepam. Drugs of choice for status epilepticus: lorazepam 4 to 8 mg, diazepam 10 mg, intravenously. *CNS*, Central nervous system; *GABA*, γ -aminobutyric acid; *NMDA*, *N*-methyl-D-aspartate; *NSAID*, nonsteroidal antiinflammatory drug.

brain excitability. Adverse effects of phenytoin include anemia, ataxia, gingival overgrowth, cosmetic changes (coarsening of facial features, hirsutism, facial acne), lethargy, skin rash, and gastrointestinal disturbances. Phenobarbital, which is considered a second-line drug, can induce hepatic microsomal enzymes that promote the metabolism of concurrently used drugs.^{41,44,46} Several antiseizure medications (see Table 27.4) may cause drowsiness, sedation, ataxia, weight gain, cognitive impairment, and hypersensitivity reactions.^{41,44,47} Adverse effects are more common at the start of therapy, when drugs are administered rapidly or at high dose. For these reasons, and to facilitate compliance, single-drug therapy and a slow increase in dose are recommended. Unfortunately, the use of combination therapy frequently is necessary for seizure control.^{44,47} Drug therapy usually is continued in children until a 1- to 2-year seizure-free period is attained, or until around age 16 years. Attempts to taper the antiepileptic drug regimen are made thereafter. Recently, medical marijuana is being considered as a potential treatment for epilepsy.⁴⁸

Vagus nerve stimulation (VNS) is reserved for patients who have been unable to achieve satisfactory seizure control with several medications, and it is an option for some before brain surgery. The mechanism of VNS is similar to that of an implantable cardiac pacemaker, in which a subcutaneous pulse generator is implanted in the left chest wall and delivers electrical signals to the left vagus nerve through a bipolar lead. The stimulated vagus nerve provides direct projection to regions in the brain potentially responsible for the seizure. The VNS device generally is used in combination with antiepileptic medications.^{41,44,46}

DENTAL MANAGEMENT

The first step in the management of an epileptic dental patient is identification of the patient as having the disorder (Box 27.8). This is best accomplished by the medical history and by discussion with the patient or family members. After a patient with epilepsy has been identified, the dental practitioner must learn as much as possible about the seizure history, including the type of seizures, age at onset, cause (if known), current and regular use of medications, frequency of physician visits, quality of seizure control, frequency of seizures, date of last seizure, and any known precipitating factors. In addition, a history of previous injuries associated with seizures and their treatment may be helpful.

Fortunately, most patients with epilepsy are able to attain good control of their seizures with anticonvulsant drugs and are therefore able to receive normal routine dental care. In some instances, however, the history may reveal a degree of seizure activity that suggests noncompliance or a severe seizure disorder that does not respond to anticonvulsants. For these patients, a consultation with the physician is advised before dental treatment is rendered.

A patient with poorly controlled disease may require additional anticonvulsant or sedative medication, as directed by the physician.

Patients who take anticonvulsants may suffer from the toxic effects of these drugs, and the dentist should be aware of these manifestations.⁴⁵⁻⁴⁷ In addition to the more common adverse effects (see Table 27.4), allergy may be seen occasionally as a rash, erythema multiforme, or worse (e.g., Stevens-Johnson syndrome). Phenytoin, carbamazepine, and valproic acid can cause bone marrow suppression, leukopenia, and thrombocytopenia, resulting in an increased incidence of microbial infection, delayed healing, and gingival and postoperative bleeding. Valproic acid can decrease platelet aggregation, leading to spontaneous hemorrhage and petechiae.^{41,45}

Propoxyphene and erythromycin should not be administered to patients who are taking carbamazepine because of interference with metabolism of carbamazepine, which could lead to toxic levels of the anticonvulsant drug.^{41,45,47} Aspirin and other nonsteroidal antiinflammatory drugs (see Table 27.4) should not be administered to patients who are taking valproic acid because these agents can further decrease platelet aggregation, leading to hemorrhagic episodes. No contraindication has been identified to the use of local anesthetics in proper amounts in these patients. Patients who have a VNS device implanted in the chest do not need antibiotic prophylaxis before undergoing invasive dental procedures.^{41,45,47}

Despite consistent use of appropriate preventive measures by both the dentist and patient, the possibility always exists that patients with epilepsy may experience a generalized tonic-clonic convulsion in the dental office. The dentist and office staff members should anticipate and be prepared for such events. Preventive measures include knowing the patient's history, scheduling the patient at a time within a few hours of taking the anticonvulsant medication, using a mouth prop, removing dentures, and discussing with the patient the urgency of mentioning an aura as soon as it is sensed. The clinician also should be aware that irritability often is a symptom of impending seizure. With a premonitory stage of sufficient duration, 0.5 to 2 mg of lorazepam can be given sublingually, or diazepam 2 to 10 mg can be given intravenously.^{41,49}

If a patient has a seizure while in the dental chair, the primary task of management is to protect the patient and try to prevent injury. No attempt should be made to move the patient to the floor. Instead, the instruments and instrument tray should be cleared from the area, and the chair should be placed in a supported supine position (Fig. 27.7). The patient's airway should be maintained patent. No attempt should be made to restrain or hold down the patient. Passive restraint should be used only to prevent injury that may result when the patient hits nearby objects or falls out of the chair.^{50,51}

If a mouth prop (e.g., a padded tongue blade between the teeth to prevent tongue biting) is used, it should be inserted at the beginning of the dental procedure (see

BOX 27.8 Dental Management Considerations in Patients With Seizure Disorders**P****Patient Evaluation and Risk Assessment (See Box 1.1)**

- Evaluate to determine the nature, severity, control, and stability of disease.

Potential Issues and Factors of Concern

- Well-controlled seizure disorders pose no specific management problems.

A

Analgesics	Clinicians should provide good pain control to avoid stress, which may precipitate a seizure.
Antibiotics	There is no need for antibiotic prophylaxis.
Anesthesia	It is very important to obtain adequate anesthesia to reduce stress as possible precipitant for a seizure. Epinephrine (1:100,000 and no more than two carpules) in local anesthetics generally is well tolerated.
Anxiety	Patients with untreated or poorly controlled seizure-associated disorders may appear very anxious and stressed, increasing the risk for a seizure. Use of special anxiety and stress reduction techniques may be indicated.
Allergy	Allergic skin changes (rash, erythema multiforme) may signify a reaction to antiepileptic medications.

B

Bleeding	The possibility of a bleeding tendency has been noted in patients taking valproic acid (Depakene) or carbamazepine (Tegretol) as the result of platelet interference.
Blood pressure	Monitor blood pressure because it may significantly increase or decrease with onset of a seizure.

C

Chair position	This usually is not a problem if the patient is under good medical management; with symptoms of impending syncope associated with cardiac stress or pulmonary congestion, however, a supine position may not be tolerated. In patients at risk for seizure, the chair back should be in supported supine position.
Consultation	When the patient is under good medical management, the dental treatment plan is unaffected. However, consultation with the patient's physician to establish the level of control is recommended as part of the management program.

D

Devices	No issues
Drugs	These patients typically take anticonvulsant drugs, which may have adverse effects including drowsiness, slow mentation, dizziness, others.

E

Equipment	No issues
Emergencies	Be prepared for occurrence of a grand mal seizure: <ul style="list-style-type: none"> Placement of a ligated mouth prop at the beginning of the procedure may be considered. The dental chair should be in supported supine position. During a seizure: <ul style="list-style-type: none"> Clear the area. Turn the patient to the side (to avoid aspiration). Do not attempt to use a padded tongue blade. Passively restrain. After a seizure: <ul style="list-style-type: none"> Examine for traumatic injuries. Discontinue treatment; arrange for patient transport. Most commonly seizures are self-limited, but rarely a seizure may progress to cardiac arrest, necessitating emergency medical treatment; call 911. A patient who is ambulatory and stable should seek urgent medical care. Ongoing vital signs must be monitored and cardiopulmonary resuscitation initiated if necessary; transport patient to emergency medical facilities.

F

Follow-up	Follow-up with the patient (and physician) is indicated. after any seizure event in the dental office. In patients who have undergone surgery, a follow-up phone call within the next day or two is advised.
-----------	--

Box 27.8). Trying to insert a mouth prop is not advised during the seizure because doing so may damage the patient's teeth or oral soft tissue and may be nearly impossible. An exception is the case in which the patient senses an impending seizure and can cooperate.^{50,51}

A grand mal seizure generally does not last longer than a few minutes. Afterward, the patient may fall into a deep sleep from which he or she cannot be aroused. Oxygen (100%), maintenance of a patent airway, and mouth

suction should be provided during this phase. Alternatively, the patient can be turned to the side to control the airway and to minimize aspiration of secretions. Within a few minutes, the patient gradually regains consciousness but may be confused, disoriented, and embarrassed. Headache is a prominent feature during this period. If the patient does not respond within a few minutes, the seizure may be associated with a low serum glucose level, and delivery of glucose may be needed.^{50,51}



FIG 27.7 Dental chair in the supine position with the back supported by the operator's or assistant's stool.



FIG 27.8 Fracture of teeth and laceration of lower lip sustained during a grand mal seizure. (Courtesy of Gerald A. Ferretti, DDS, Lexington, KY.)

No further dental treatment should be attempted after a generalized tonic-clonic seizure, although examination for sustained injuries (e.g., lacerations, fractures) should be performed. In the event of avulsed or fractured teeth (Fig. 27.8) or a fractured appliance, an attempt should be made to locate the tooth or fragments to rule out aspiration. A chest radiograph may be required to locate a missing fragment or tooth.^{50,51}

In the event that a seizure becomes prolonged (status epilepticus) or is repeated, IV lorazepam (0.05–0.1 mg/kg) 4 to 8 mg, or 10 mg of diazepam, generally is effective in controlling it. Lorazepam is preferred by many experts



FIG 27.9 Phenytoin-induced gingival overgrowth. (Courtesy of H. Abrams, Lexington, KY.)

because it is more efficacious and lasts longer than diazepam.⁴¹ Oxygen and respiratory support should be provided because respiratory function may become depressed. If the seizure lasts longer than 15 minutes, the following protocol should be implemented: secure IV access, repeat lorazepam dosing, administer fosphenytoin, and activate the EMS system.^{50,51}

Because gingival overgrowth is associated with phenytoin administration, every effort should be made to maintain a patient at an optimal level of oral hygiene.^{45,47} This may require frequent visits for monitoring of progress. If gingival overgrowth is significant, surgical reduction will be necessary. This correction must be accompanied by an increased awareness of oral hygiene needs and a positive commitment by the patient to maintain oral cleanliness.

A missing tooth or teeth should be replaced if possible to prevent the tongue from being caught in the edentulous space during a seizure (as commonly happens). Generally, a fixed prosthesis or implant is preferable to a removable one. (The removable prosthesis becomes dislodged more easily.) For fixed prostheses, all-metal units should be considered when possible to minimize the chance of fracture. When placing anterior castings, the dentist may wish to consider using three-quarter crowns or retentive nonporcelain facings.

Removable prostheses are nevertheless sometimes constructed for patients with epilepsy. Metallic palates and bases are preferable to all-acrylic ones. If acrylic is used, it should be reinforced with wire mesh.

Oral Complications and Manifestations

The most significant oral complication seen in patients with epilepsy is gingival overgrowth, which is associated with phenytoin (Fig. 27.9) and rarely with valproic acid and vigabatrin.^{47,50} The incidence of phenytoin-induced gingival overgrowth in patients with epilepsy ranges from

0% to 100%, with an average rate of approximately 42%. A greater tendency to develop gingival overgrowth occurs in youngsters than in adults. The anterior labial surfaces of the maxillary and mandibular gingivae are most commonly and severely affected.^{47,50}

Meticulous oral hygiene is important for preventing overgrowth and significantly decreasing its severity. Good home care must always be combined with the removal of irritants, such as overhanging restorations and calculus. Frequently, enlarged tissues interfere with function or appearance, and surgical reduction may become necessary.

Traumatic injuries such as broken teeth, tongue lacerations, and lip scars also are common in patients who experience generalized tonic-clonic seizures. Stomatitis, erythema multiforme, and Stevens-Johnson syndrome are rare adverse effects associated with the use of phenytoin, valproic acid, lamotrigine, phenobarbital, and carbamazepine. These complications are more common during the first 8 weeks of treatment.^{47,50}

MULTIPLE SCLEROSIS

GENERAL DESCRIPTION

Multiple sclerosis is the most common autoimmune disease of the nervous system. MS is characterized by chronic and continuous demyelination of the corticospinal tract neurons in two or more regions of the brain and spinal cord. MS typically manifests in young adults with episodic neurologic dysfunction, and 85% of patients present with relapsing and remitting symptoms.⁵²⁻⁵⁶ Demyelinated regions are limited to the white matter of the CNS and are randomly located and multiple (Fig. 27.10). The peripheral nervous system is not affected.⁵⁶

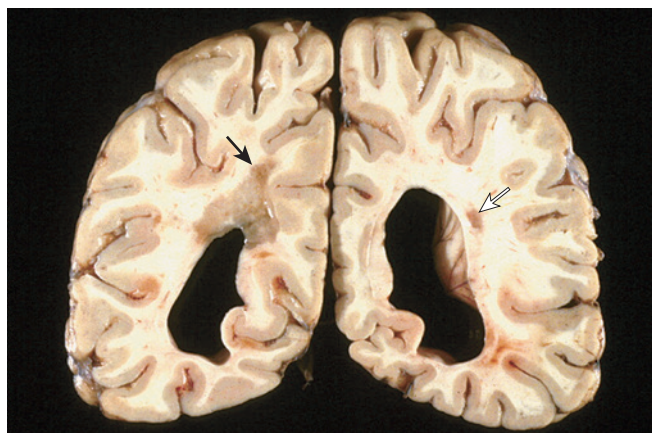

FIG 27.10 Multiple sclerosis. Large periventricular “demyelinated plaque” (dark region above left ventricle, black arrow) and smaller “demyelinated plaque” (white arrow) lateral to the right ventricle, shown in a coronal section of the brain of a patient who had multiple sclerosis. (Courtesy of Daron G. Davis, MD, Lexington, KY.)

EPIDEMIOLOGY

Multiple sclerosis is second only to head trauma as the leading cause of neurologic disability in young adults. Approximately 400,000 people in the United States and more than 1 million worldwide have the disease, for a prevalence rate of about 1 case per 1000 persons.⁵⁶⁻⁵⁸ The incidence of MS has been increasing beginning in the past century. The disease typically manifests between the ages of 15 to 50 years and affects women twice as often as men. Its prevalence is highest in the temperate regions of the world (i.e., Northern and Southern latitudes), and it is infrequently seen along the Equator.⁵⁶⁻⁵⁸ Dentists who manage 2000 adult patients can expect to have about 3 patients in their practice in whom this condition has been diagnosed.

Pathophysiology and Complications

Multiple sclerosis involves autoimmune-mediated inflammation that leads to demyelination and axonal injury. The cause of MS remains unknown; however, it is widely held that the disease is triggered by an infectious agent. Initial support for this association arises from cluster studies of MS outbreaks in small geographic regions. Over the past century, several microbes (e.g., rabies virus, measles virus, herpesviruses, *Chlamydia pneumoniae*) have been purported to be associated with MS. In recent years, human herpesvirus type 6 (HHV-6) has been identified in active demyelinated regions of the CNS in patients who have MS.⁵⁹⁻⁶¹ It is hypothesized that this neurotropic virus, in combination with host genetic factors, mediates processes that cause immune-mediated attacks on myelin. However, not all persons who are infected with human HHV-6 develop MS, suggesting that genetic factors and other environmental factors also are important.⁵⁷ Consistent with the role of genetic factor involvement, the concordance rate among monozygotic twins is 30%. Risk is increased when human leukocyte antigen DR2 is carried by a person of Northern European ancestry.^{51,52}

Demyelination of MS occurs in scattered white matter regions in the brain. Areas of myelin loss range in size from 1 mm to several centimeters in diameter.^{56,59,60} Affected regions show inflammatory demyelination and axonal damage with accumulation of macrophages, B and T lymphocytes, and plasma cells. Specifically, myelin-reactive type 1 helper T cells (T_H1) that produce lymphotoxin and interferon- γ , but little interleukin-4 (IL-4), appear to be central to the pathogenesis of this disease.^{56,59,60} The acute MS lesion is accompanied by generation of inflammatory cytokines and antimyelin immunoglobulins that influence macrophages to attack myelin, resulting in tissue destruction, swelling, and breakdown of the blood-brain barrier. Demyelinated disease areas or “plaques” show impairment in axonal conduction; such changes constitute the basic pathophysiologic defect. The most commonly affected regions are the optic nerve, periventricular cerebral white matter, and cervical spinal cord.^{56,59,60}

A significant complication of the axonal damage associated with MS is that 50% of patients need help to walk within 15 years of onset of the disease. Continued muscle atrophy can lead to restriction to a wheelchair or a bed, thus increasing the chances for development of pneumonia. The risk of ischemic stroke in patients with MS is significantly higher than normal.⁶⁰ The life expectancy for patients with MS is calculated to be 82.5% of normal (≈ 58 years).^{56,59,60}

CLINICAL PRESENTATION

The first clinical signs of MS often appear in young adulthood. Clinical manifestations vary according to which region of the CNS is involved (motor or sensory region) and what degree of disruption occurs in the myelin sheath. Disturbances in visual function (sometimes resulting in blindness) and abnormal eye movements (nystagmus and double vision) are the most common presenting manifestations. Motor disturbances that affect walking and use of the hands (incoordination, spasticity, difficulty in walking, loss of balance and vertigo, coordination or weakness, tremor or paralysis of a limb) and that cause bowel and bladder incontinence; spastic paresis of skeletal muscles (imprecise speech or tremor); and sensory disturbances, including loss of touch, pain, temperature, and proprioception (numbness, pins and needles sensations) are common.^{56,59,60} Fatigue is a major symptom (occurring in up to 90%), and worsening fatigue occurs in the afternoon. Symptoms are exacerbated by heat (hot baths, sun exposure) and dehydration and generally emerge over a few days before stabilizing and subsiding a few weeks later. Problems with concentration also occur.^{56,59,60}

A typical presentation consists of attacks and relapses that recur for several years. The course is unpredictable and depends on the frequency of attacks and the extent of recovery. Four categories have been used to describe the course of the disease: relapsing-remitting (occurs in 85% of patients), primary progressive, secondary progressive, and progressive-relapsing. Recovery in most cases is temporary because remyelination is only transient. Repeated attacks can cause permanent physical damage; however, intellectual function remains intact. Depression and emotional instability are features that commonly accompany this disease.^{56,59,60}

Laboratory and Diagnostic Findings

The diagnosis of MS usually is made on the basis of information derived from the history, clinical examination, CSF analysis, sensory evoked potential studies, and MRI performed over time.^{57,61,62} The relapsing-remitting variant is diagnosed when two or more clinical attacks occur in a patient who has two or more affected CNS locations or when a new MRI lesion appears after a second clinical attack.^{56,59,62} The disease also is diagnosed after one clinical attack when a new MRI lesion appears. MRI scans typically reveal multiple hypodense demyelinated regions

(plaques) in white matter, usually near the ventricles (see Fig. 27.10), brainstem cerebellum, and optic nerves.^{56,59,62}

The CSF shows signs of low-grade inflammation, and protein and immunoglobulin levels are increased in 80% to 90% of patients. Antibodies to myelin basic protein also can be detected in the CSF. Myelin destruction causes slowing of conduction velocity. The conduction response to visual stimuli (visual evoked potential) or to somatosensory evoked stimuli usually is delayed and altered in amplitude.^{56,59,62}

MEDICAL MANAGEMENT

Patients with relapsing forms of MS are given antiinflammatory medications in the form of IV corticosteroids (methylprednisolone) for acute attacks or interferon beta-1a (Avonex) or interferon beta-1b (Betaseron) injections.^{63,64} The interferons reduce antigen presentation, proliferation of T cells, and production of tumor necrosis factor and have been shown to slow the progression of disease.^{63,64} (Table 27.5). Corticosteroids have many antiinflammatory functions, including the ability to block eicosanoid and cytokine release and endothelial cell expression of intracellular and extracellular adhesion molecules (ICAMs and ELAMs, respectively), which attract neutrophils. Interferons and glatiramer acetate (Copaxone), a myelin-like polypeptide that suppresses T cell attacks on the myelin sheath, are used during periods of remission to reduce the rate of clinical relapse.⁶³⁻⁶⁵ Use of mitoxantrone, an antineoplastic medication that arrests cell cycle and reduces T_H1 cytokines, is reserved for patients who have aggressive disease and whose symptoms are worsening despite therapy. This agent is used on a short-term basis with glatiramer. However, mitoxantrone use is associated with cardiac complications and risk for leukemia.^{66,67}

Some of the newer biologic agents, such as natalizumab, ustekinumab, and rituximab, have shown promise in treating MS.^{63-66,68,69} Additionally, clinical trials with cladribine have shown promise, particularly in cases of relapsing MS.⁷⁰ Other more recent studies indicate that treatment with vitamin D and the hydroxymethylglutaryl-coenzyme A (HMG-CoA) reductase inhibitors (statins) as well as a new monoclonal antibody (GNbAC1) that is directed toward a retrovirus may be effective for management of MS.^{59,71-73}

Many complications of MS require management with several drugs. Spasticity is managed with antispastic drugs such as baclofen (a GABA agonist), benzodiazepines (GABA receptor activators), dantrolene (modifier of calcium release in muscle fibers), and tizanidine (Zanaflex) (an α_2 -adrenergic agonist). An implantable pump for intrathecal administration of baclofen sometimes is used. Poor bladder control is managed with anticholinergics such as oxybutynin (Ditropan) or tolterodine tartrate (Detrol). Fatigue is managed with afternoon naps, exercise, and amantadine (Symmetrel) or modafinil. Paroxysmal

TABLE 27.5 Drugs Used in the Management of Multiple Sclerosis

Drug	Dental Management Considerations	Local Anesthetic or Vasoconstrictor
PRIMARY DRUGS		
Interferon beta-1a (Avonex, Rebif) injection	Transient flulike symptoms, anemia uncommon; may increase anticoagulant effects of warfarin	No information to suggest that any special precautions are required
Interferon beta-1b (Betaseron) injection	Transient flulike symptoms, anemia uncommon	No information to suggest that any special precautions are required
Natalizumab, ustekinumab, rituximab	Transient flulike symptoms, anemia uncommon, lymphoma	
ALTERNATIVES		
Glatiramer acetate (Copaxone) injection	Ulcerative stomatitis, lymphadenopathy, and salivary gland enlargement	No information to suggest that any special precautions are required
Mitoxantrone (Novantrone) infusion	Leukopenia, risk for cardiac complications and leukemia, mucositis, and stomatitis	No information to suggest that any special precautions are required

events respond to carbamazepine, phenytoin, gabapentin, and pergolide. Serotonin reuptake inhibitors (e.g., fluoxetine [Prozac]) and tricyclic antidepressants (TCAs) are used to manage the depression that accompanies MS in about half the patients. Associated conditions (e.g., trigeminal neuralgia, headache, optic neuritis) often are managed by experts in chronic pain clinics.^{56,67,74-76}

DENTAL MANAGEMENT

The dentist can play an important role in directing the patient with clinical findings suggestive of MS to the appropriate health care provider for definitive diagnosis. Reports of abnormal facial pain (mimicking trigeminal neuralgia), numbness of an extremity, visual disturbance, or muscle weakness require the dentist to perform a neuromuscular examination to rule out MS. The disease should be suspected if onset is progressive over several days, the patient is between 20 and 35 years of age, and afternoon fatigue is a feature. Referral to a neurologist is the next step in confirming the diagnosis.^{56,60}

Patients experiencing a relapse are unfit to receive routine dental care. Emergency dental care can be provided but is affected by the medications these patients take. In particular, corticosteroids are immunosuppressive, and during stressful surgical procedures, an increase in dose may be required (see Chapter 15). The physician should be consulted before emergency dental care is provided to these patients.

The optimal time for treating patients with MS is during periods of remission. The dental care plan should take into consideration the potential effects on oral health of the medications used in management of MS. In particular, the anticholinergics (oxybutynin, tolterodine tartrate) and TCAs can cause a dry or burning mouth, which may require the use of salivary substitutes for relief.^{77,78} If additional relief is needed, the use of pilocarpine (see Appendix C) should be discussed with the physician. Several of the medications used in the treatment of patients

with MS are immunosuppressants, thus placing patients at risk for opportunistic and community-acquired infections and for the development of cancers.^{56,63}

Treatment planning changes are dictated by levels of motor impairment and fatigue. Patients with stable disease and little motor spasticity or weakness can receive routine dental care. Patients with more advanced disease may require help in transferring to and from the dental chair, may have difficulty maintaining oral hygiene, and may be poor candidates for reconstructive and prosthetic procedures. Because fatigue is often worse in the afternoon, short morning appointments are advised.

Oral Complications and Manifestations

Oral manifestations of MS are reported to occur in 2% to 3% of affected persons.^{60,75,78} These features may serve as the presenting symptoms of MS. The most common features include dysarthria, paresthesia, numbness of the orofacial structures, and trigeminal neuralgia. Dysarthria produces slow, irregular speech with unusual separation of syllables of words, referred to as *scanning speech*. During an attack, the patient may experience facial paresthesia, and muscles of facial expression (especially the periorbital) can undulate in a wavelike motion. The term *myokymia* is used to describe these unusual muscle movements, which have been said to feel like a “bag of worms” on palpation. Referral to a physician is advised if the condition has not been diagnosed.^{60,75,78}

Trigeminal neuralgia is 400 times more likely among persons with MS than among the general population. Relief of trigeminal neuralgia pain can be obtained with the use of carbamazepine, clonazepam, or amitriptyline or surgery.^{60,75,76,78}

CEREBROSPINAL FLUID SHUNTS

Within the spectrum of neurologic disorders is the condition known as *hydrocephalus*, characterized by an increasing accumulation of CSF within the cerebral

ventricles. Management of this condition often requires placement of a shunt within cerebral ventricles and peripheral cavities to reduce increased CSF pressure. Several types of shunts are used to reduce fluid pressure; ventriculoperitoneal, ventriculoatrial, and lumboperitoneal are the most common types.⁷⁹⁻⁸⁴ In the United States, around 75,000 CSF shunts are placed each year.⁷⁹⁻⁸⁴

With respect to dentistry, the most significant concern is the risk of CSF shunt infection. Overall, shunt infection rates range from about 5% to 15%, with most infections resulting from wound contamination. Almost 70% of infections are caused by skin flora staphylococcal organisms.⁸³⁻⁸⁴ CSF shunt infections usually occur within 2 months after implantation. The infection rate is higher for ventriculoperitoneal shunts than for ventriculoatrial shunts. However, other types of complications include thromboemboli, severe complications of infection, and shunt malfunctions.⁸³⁻⁸⁴

Cerebrospinal fluid shunts do not appear to increase the risk for infection produced by hematogenous seeding of bacteria after dental procedures. Thus, the American Heart Association has issued a statement indicating that antibiotic prophylaxis is not recommended for patients with CSF shunts who are undergoing dental procedures.⁸⁵

REFERENCES

1. CDC, NCHS. Underlying Cause of Death 1999-2013 on CDC WONDER Online Database, released 2015. Data are from the Multiple Cause of Death Files, 1999-2013, as compiled from data provided by the 57 vital statistics jurisdictions through the Vital Statistics Cooperative Program. Accessed 3 February 2015.
2. Mozaffarian D, Benjamin EJ, Go AS, et al. Heart disease and stroke statistics—2015 update: a report from the American Heart Association. *Circulation*. 2015;131(4):e29-e322.
3. CDC. Prevalence of stroke — United States, 2006–2010. *MMWR Morb Mortal Wkly Rep*. 2012;61(20):379-382.
4. Hall MJ, Levant S, DeFrances CJ. Hospitalization for stroke in U.S. hospitals, 1989–2009 [PDF-322K]. NCHS data brief, No. 95. Hyattsville, MD: National Center for Health Statistics; 2012.
5. Zivn JA. Ischemic cerebrovascular disease. In: Goldman L, Schafer AI, eds. *Cecil Textbook of Medicine*. 24th ed. Elsevier; 2012:2310-2320, [Chapter 414]. ISBN 978-1-4377-1604-7.
6. Zivn JA. Hemorrhagic cerebrovascular disease. In: Goldman L, Schafer AI, eds. *Cecil Textbook of Medicine*. 24th ed. Elsevier; 2012:2320-2339, [Chapter 415]. ISBN 978-1-4377-1604-7.
7. CDC. Vital signs: awareness and treatment of uncontrolled hypertension among adults—United States, 2003–2010. *MMWR Morb Mortal Wkly Rep*. 2012;61(35):703-709.
8. Konecny P, Elfmark M, Urbanek K. Facial paresis after stroke and its impact on patients' facial movement and mental status. *J Rehabil Med*. 2011;43:73-75.
9. Fatahzadeh M, Glick M. Stroke: epidemiology, classification, risk factors, complications, diagnosis, prevention, and medical and dental management. *Oral Surg Oral Med Oral Pathol Oral Radiol Endod*. 2006;102:180-191.
10. Elad S, Zadik Y, Kaufman E, et al. A new management approach for dental treatment after a cerebrovascular event: a comparative retrospective study. *Oral Surg Oral Med Oral Pathol Oral Radiol Endod*. 2010;110:145-150.
11. Furlan A, Higashida R, Wechsler L, et al. Intra-arterial prourokinase for acute ischemic stroke. *JAMA*. 1999;282:2003-2011.
12. Albers GW, Bates VE, Clark WM, et al. Intravenous tissue-type plasminogen activator for treatment of acute stroke. *JAMA*. 2000;283:1145-1150.
13. Khaja A. Acute ischemic stroke management. *Neurol Clin*. 2008;26:224-232.
14. Minassian C, D'Aiuto F, Hingorani AD, et al. Invasive dental treatment and risk for vascular events: a self-controlled case series. *Ann Intern Med*. 2010;153:499-506.
15. Shobha N, Bhatia R, Barber PA. Dental procedures and stroke: a case of vertebral artery dissection. *J Can Dent Assoc*. 2010;76:a82.
16. Hacke W, Wahlgren N, Ahmedet N, et al. Thrombolysis with alteplase for acute ischaemic stroke in the Safe Implementation of Thrombolysis in Stroke-Monitoring Study (SITS-MOST): an observational study. *Lancet*. 2007;369(9558):275-282.
17. Mupparapu M, Kim IH. Calcified carotid artery atheroma and stroke: a systematic review. *J Am Dent Assoc*. 2007;138:483-492.
18. Friedlander AH. Calcified carotid artery atheromas. *J Am Dent Assoc*. 2007;138:1191-1192.
19. Masood F, Wild RC, Jenkins J, et al. Presence of carotid artery calcification on panoramic radiographs of patients with chronic diseases. *Gen Dent*. 2009;57:39-44.
20. Lang AE. Parkinsonism. In: Goldman L, Schafer AI, eds. *Cecil Textbook of Medicine*. 25th ed. Elsevier; 2016: 2326-2399, [Chapter 416]. ISBN 978-1-4377-1604-7.
21. Friedlander AH, Mahler M, Norman KM, et al. Parkinson disease: systemic and orofacial manifestations, medical and dental management. *J Am Dent Assoc*. 2009;140:658-669.
22. American Parkinson's Disease Association. www.apda.parkinson.org. 2015.
23. Yokota O, Tsuchiya K, Uchihara T, et al. Lewy body variant of Alzheimer's disease or cerebral type Lewy body disease? Two autopsy cases of presenile onset with minimal involvement of the brainstem. *Neuropathology*. 2007;27:21-35.
24. Ravina B, Marder K, Fernandez HH, et al. Diagnostic criteria for psychosis in Parkinson's disease: report of an NINDS, NIMH work group. *Mov Disord*. 2007;22:1061-1068.
25. Grover S, Rhodus NL. "Parkinson's disease: dental treatment considerations. *Northwest Dent*. 2011;90(4):21-26.
26. Ravina B, Elm J, Camicioli R, et al. The course of depressive symptoms in early Parkinson's disease. *Mov Disord*. 2009;24:1306-1311.

27. Hallet M, Litvan I. Evaluation of surgery for Parkinson's disease. *Neurol Res.* 1999;53:1910-1921.
28. Kordower JH, Emborg ME, Bloch J, et al. Neurogeneration prevented by lentiviral vector. *Science.* 2000;290:767-772.
29. Knopman DS. Alzheimer's disease. In: Goldman L, Schafer AI, eds. *Cecil Textbook of Medicine.* 25th ed. Elsevier; 2016:996-1007, [Chapter 409]. ISBN 978-1-4377-1604-7.
30. Dementia fact sheet. www.WHO.INT/mediactive/factsheet/2015.
31. Americans with Alzheimer's. American Alzheimer Organization. <http://www.alz.org/facts/2015>.
32. Yoshida H, Terada S, Ishizu H, et al. An autopsy case of Creutzfeldt-Jakob disease with a V180I mutation of the PrP gene and Alzheimer-type pathology. *Neuropathology.* 2010;30:159-164.
33. Hu Z, Ou Y, Duan K, et al. Inflammation: a bridge between postoperative cognitive dysfunction and Alzheimer's disease. *Med Hypotheses.* 2010;74:722-724.
34. Levin EC, Acharya NK, Sedeyn JC, et al. Neuronal expression of vimentin in the Alzheimer's disease brain may be part of a generalized dendritic damage-response mechanism. *Brain Res.* 2009;1298:194-207.
35. Morris JC, Ernesto C, Schafer K, et al. Clinical dementia rating training and reliability in multicenter studies. *Neurology.* 2012;48(6):1508-1516.
36. Henry RG, Smith BJ. Managing older patients who have neurologic disease: Alzheimer disease and cerebrovascular accident. *Dent Clin North Am.* 2009;53:269-294, ix.
37. Wilkinson DG, Francis PT, Schwam E, et al. Cholinesterase inhibitors used in the treatment of Alzheimer's disease: the relationship between pharmacological effects and clinical efficacy. *Drugs Aging.* 2004;21:453-459.
38. Standard treatment for Alzheimer's disease. http://www.alz.org/alzheimers_disease_standard_prescriptions.asp?gclid=CJDO6Ivul8kCFQeNaQod0UoCGg. 2015.
39. Sacco D, Frost DE. Dental management of patients with stroke or Alzheimer's disease. *Dent Clin North Am.* 2006;50:625-633, viii.
40. Rejnefelt I, Andersson P, Renvert S. Oral health status in individuals with dementia living in special facilities. *Int J Dent Hyg.* 2006;4:67-71.
41. Wielbe S. Epilepsy. In: Goldman L, Schafer AI, eds. *Cecil Textbook of Medicine.* 25th ed. Elsevier; 2016:2283-2369, [Chapter 410]. ISBN 978-1-4377-1604-7.
42. Epilepsy statistics. Epilepsy Foundation. <http://www.epilepsy.com/learn/epilepsy-statistics>. 2015.
43. Sillanpaa M, Shinnar S. Long-term mortality in childhood-onset epilepsy. *N Engl J Med.* 2010;363:2522-2527.
44. Sperling MR, Feldman H, Kinman J, et al. Seizure control and mortality in epilepsy. *Ann Neurol.* 1999;46:45-50.
45. Camfield C, Camfield P. Management guidelines for children with idiopathic generalized epilepsy. *Epilepsia.* 2005;46(suppl 9):112-116.
46. Yo DY, Benbadis SR. Epilepsy and seizures treatment and management. <http://emedicine.medscape.com/article/1184846-treatment>. 2015.
47. Greenwood RS. Adverse effects of antiepileptic drugs. *Epilepsia.* 2000;41(suppl 2):S42-S52.
48. Friedman D, Devinsky O. Cannabinoids in the treatment of epilepsy. *N Engl J Med.* 2016;374(1):94-95.
49. Ford PJ, Amazaki K, Seymour GJ. Cardiovascular and oral disease interactions: what is the evidence? *Prim Dent Care.* 2007;14:59-66.
50. Guerrini R. Epilepsy in children. *Lancet.* 2006;367:499-506.
51. Lewandowski L, Osmola K, Grodzki J. [Dyskinesias of the tongue and other face structures]. *Ann Acad Med Stetin.* 2006;52(suppl 3):61-63.
52. Sloka S, Silva C, Pryse-Phillips W, et al. A quantitative analysis of suspected environmental causes of MS. *Can J Neurol Sci.* 2011;38:98-105.
53. Bähr M. Special issue on multiple sclerosis. *Exp Neurol.* 2010;225:1.
54. Hauser SL, Goodin DS. Multiple sclerosis and demyelinating conditions. In: Fauci AS, et al, eds. *Harrison's Principles of Internal Medicine.* 18th ed. McGraw-Hill, NY, NY; 2015:2611-2631, [Chapter 376].
55. National Multiple Sclerosis Society. What causes MS? <http://www.nationalmssociety.org/What-is-MS/What-Causes-MS>. 2015.
56. Calabresi PA. Multiple sclerosis and demyelinating conditions of the central nervous system. In: Goldman L, Schafer AI, eds. *Cecil Textbook of Medicine.* 25th ed. Elsevier; 2016:2347-2359, [Chapter 419]. ISBN 978-1-4377-1604-7.
57. Motl RW, McAuley E, Sandroff BM, et al. Descriptive epidemiology of multiple sclerosis. *Acta Neurol Scand.* 2015;131(2):422-426.
58. Koch-Henrikson N, Sorenson PS. The changing demographic pattern of multiple sclerosis. *Lancet Neurol.* 2011;9(5):52-525.
59. Bermel RA, Cohen JA. Multiple sclerosis: advances in understanding pathogenesis and emergence of oral treatment options. *Lancet Neurol.* 2011;10:4-5.
60. Tseng CH, Huang WS, Lin CK, et al. Increased risk of ischemic stroke among patients with multiple sclerosis. *Eur J Neurol.* 2015;22(3):500-506.
61. Prat A. Special issue on molecular basis of multiple sclerosis. *Biochim Biophys Acta.* 2011;1812:131.
62. Sormani M, Bonzano L, Roccatagliata L, et al. Magnetic resonance imaging as surrogate for clinical endpoints in multiple sclerosis: data on novel oral drugs. *Mult Scler.* 2011;17:630-633.
63. Popova NE, Kamchatnov PR, Riabukhina OV, et al. [Omaron in the complex treatment of patients with multiple sclerosis]. *Zh Nevrol Psikhiatr Im S S Korsakova.* 2010;110:17-20.
64. Oliver BJ, Kohli E, Kasper LH. Interferon therapy in relapsing-remitting multiple sclerosis: a systematic review and meta-analysis of the comparative trials. *J Neurol Sci.* 2011;302:96-105.
65. Oliver B, Fernández O, Orpez T, et al. Kinetics and incidence of anti-natalizumab antibodies in multiple

- sclerosis patients on treatment for 18 months. *Mult Scler*. 2011;17:368-371.
66. Yeh EA, Weinstock-Guttman B. Natalizumab in pediatric multiple sclerosis patients. *Ther Adv Neurol Disord*. 2010;3:293-299.
67. Kieseier BC, Jeffery DR. Chemotherapeutics in the treatment of multiple sclerosis. *Ther Adv Neurol Disord*. 2010;3:277-291.
68. Scherl EJ, Kumar S, Warren RU. Review of the safety and efficacy of ustekinumab. *Therap Adv Gastroenterol*. 2010;3:321-328.
69. Taupin P. Antibodies against CD20 (rituximab) for treating multiple sclerosis: US20100233121. *Expert Opin Ther Pat*. 2011;21:111-114.
70. Giovanni G, Comi G, Cook S, et al; CLARITY Study Group. A placebo-controlled clinical trial of cladribine for relapsing multiple sclerosis. *N Engl J Med*. 2010;362:416-422.
71. Wang J, Xiao Y, Luo M, et al. Statins for multiple sclerosis. *Cochrane Database Syst Rev*. 2010;(12):CD008386.
72. Neau JP, Artaud-Uriot MS, Lhomme V, et al. [Vitamin D and multiple sclerosis. A prospective survey of patients of Poitou-Charentes area]. *Rev Neurol (Paris)*. 2011;167:317-323.
73. Derfuss T. A phase IIa randomised clinical trial of GNBAC1, an humanized monoclonal antibody against the envelope protein of MS- associated endogenous retrovirus in MS. *Multiple Sclerosis J*. 2015;22(1):105-111.
74. Haacke EM. Chronic cerebral spinal venous insufficiency in multiple sclerosis. *Expert Rev Neurother*. 2011;11:5-9.
75. Mollaoglu M, Fertelli TK, Tuncay FÖ. Disability in elderly patients with chronic neurological illness: stroke, multiple sclerosis and epilepsy. *Arch Gerontol Geriatr*. 2011;53:e227-e231.
76. Grau-López L, Sierra S, Martínez-Cáceres E, et al. [Analysis of the pain in multiple sclerosis patients]. *Neurologia*. 2011;26:208-213.
77. Danhauer SC, Miller CS, Rhodus NL, et al. Impact of criteria-based diagnosis of burning mouth syndrome on treatment outcome. *J Orofac Pain*. 2002;16:305-311.
78. Rhodus NL, Carlson CR, Miller CS. Burning mouth (syndrome) disorder. *Quintessence Int*. 2003;34:587-593.
79. Walker ML. Shunt survival. *J Neurosurg Pediatr*. 2010;6:526.
80. Paulsen AH, Lundar T, Lindegaard KF. Twenty-year outcome in young adults with childhood hydrocephalus: assessment of surgical outcome, work participation, and health-related quality of life. *J Neurosurg Pediatr*. 2010;6:527-535.
81. Lundkvist B, Koskinen LO, Birgander R, et al. Cerebrospinal fluid dynamics and long-term survival of the Strata® valve in idiopathic normal pressure hydrocephalus. *Acta Neurol Scand*. 2011;124:115-121.
82. Chern JJ, Macias CG, Jea A, et al. Effectiveness of a clinical pathway for patients with cerebrospinal fluid shunt malfunction. *J Neurosurg Pediatr*. 2010;6:318-324.
83. Aoki N. Lumboperitoneal shunt: clinical implications, complications, and comparison with ventriculoperitoneal shunt. *Neurosurgery*. 1990;26:998-1003.
84. Gardner P, Leipzig TJ, Sadigh M. Infections of cerebrovascular shunts. *Curr Clin Top Infect Dis*. 1989;9:185-189.
85. Baddour LM, Bettmann MA, Bolger AF, et al; AHA. Nonvalvular cardiovascular device related infections. *Circulation*. 2003;108:2015-2023.

Anxiety and Eating Disorders

DEFINITION

This chapter discusses anxiety disorders (panic, phobias, posttraumatic stress disorder [PTSD], and generalized anxiety disorder) and eating disorders (Box 28.1). Adverse reactions and drug interactions associated with drugs used to treat anxiety states are covered, with an emphasis on the dental implications of these reactions. The dental management of patients with anxiety and eating disorders is covered in detail. Chapter 29 is devoted to mood disorders (depression and bipolar disorders), somatoform disorders (conversion, hypochondriasis, pain, somatization), and schizophrenia. Dementia is discussed in Chapter 27 and substance abuse in Chapter 30.

Problems may be encountered in the dental practice that stem from a patient's behavioral patterns rather than from physical conditions. A good dentist–patient relationship can reduce the number of behavioral problems encountered in practice and can modify the intensity of emotional reactions. A positive dentist–patient relationship is based on mutual respect, trust, understanding, cooperation, and empathy. Role conflicts between the dentist and the patient should be avoided or should be identified and dealt with effectively. An anxious patient should be offered support that minimizes the damaging effects of anxiety, and an angry or uncooperative patient should be accepted and encouraged to share her or his reasons for feelings and behavior, allowing emergence of a more peaceful and cooperative state of mind. Patients with emotional factors that contribute to oral or systemic diseases or symptoms and patients with more serious mental disorders can be managed in an understanding, safe, and empathetic manner.

The American Psychiatric Association published the fifth edition of the *Diagnostic and Statistical Manual of Mental Disorders* (DSM) in 2013.¹ It includes detailed descriptions of neurodevelopmental disorders, schizophrenia spectrum and other psychotic disorders, bipolar and related disorders, depressive disorders, anxiety disorders, feeding and eating disorders, sleep–wake disorders, substance-related disorders, addictive disorders, and other topics.

The authors are aware of the implications of applying the new fifth edition of the DSM. We decided to postpone the application. This was based on the need to see how

well accepted it becomes. In this edition, the fourth edition of the DSM is used.

COMPLICATIONS: Inability to function, insomnia, secondary drug and alcohol abuse, starvation, suicide, and death.

ANXIETY DISORDERS

DEFINITION

Anxiety is a natural response and a necessary warning adaptation in humans. Anxiety becomes a pathologic disorder when it is excessive and uncontrollable, requires no specific external stimulus, and results in physical and affective symptoms and changes in behavior and cognition.² Anxiety disorders occur in two patterns: (1) chronic, generalized anxiety and (2) episodic, panic-like anxiety.³ Several related psychiatric disorders often coexist with anxiety disorders, including PTSD, substance abuse, and depression.³

Anxiety is a sense of psychological distress that may not have a focus. It is a state of apprehension that may involve an internal psychological conflict, an environmental stress, a physical disease state, a medicine or drug effect, or combinations of these. Anxiety can be a purely psychological experience, with few somatic manifestations. Alternatively, it can be experienced as a purely physical phenomenon encompassing tachycardia, palpitations, chest pain, indigestion, headaches, and so forth, with no psychological distress other than concern about the physical symptoms. The reason for the variability in physical responses is not clear.²⁻⁵

An understanding of anxiety requires definitions of some related entities, phobia and panic attack. A *phobia* is defined as an irrational fear that interferes with normal behavior. Phobias are fears of specific objects, situations, or experiences. The feared object, situation, or experience has taken on a symbolic meaning for the patient. Unconscious wishes and fears have been displaced from an original goal onto an external object.⁶

A *panic attack* consists of a sudden, unexpected, overwhelming feeling of terror with symptoms of dyspnea, palpitations, dizziness, faintness, trembling, sweating, choking, flushes or chills, numbness or tingling sensations, and chest pains. The panic attack peaks in about 10

BOX 28.1 Classification of Behavioral and Psychiatric Disorders**Anxiety Disorders**

- Panic disorders
- Agoraphobia
- Phobias
- Obsessive-compulsive disorder*
- Posttraumatic stress disorder
- Acute stress disorder
- Generalized anxiety disorder
- Anxiety disorder due to a general medical condition*
- Substance-induced anxiety disorder*

Mood Disorders

- Depressive disorders
- Major depression
- Dysthymic disorder
- Depression not otherwise specified
- Bipolar disorders
- Bipolar I—manic, mixed, depressed
- Bipolar II—hypomanic, depressed
- Cyclothymic disorder
- Bipolar not otherwise specified

Somatoform Disorders

- Body dysmorphic disorder*
- Conversion disorder
- Hypochondriasis
- Somatization disorder
- Pain disorder

Factitious Disorders

- Predominantly psychological signs and symptoms
- Predominantly physical signs and symptoms
- Combined psychological and physical signs and symptoms

Psychological Factors That Affect Medical Conditions*

- Mental disorder affecting medical condition*
- Stress-related physiologic response affecting medical condition*

Substance Abuse Disorders*

- Alcohol and other sedatives (barbiturates, benzodiazepines, others)*
- Opiates*
- Stimulants (amphetamine, cocaine)*
- Cannabis*
- Hallucinogens (lysergic acid diethylamide [LSD], phencyclidine [PCP])*
- Nicotine*
- Others (steroids; inhalants such as paint, glue, and gasoline)*

Cognitive Disorders*

- Delirium*
- Dementia*
 - Primary (Alzheimer type)*
 - Vascular*
- Human immunodeficiency virus (HIV) infection–related (AIDS dementia)*
- Parkinson disease*
- Amnesic disorder*

Schizophrenia

- Catatonic type
- Disorganized type
- Paranoid type
- Undifferentiated type

Delusional (Paranoid) Disorder*

- Erotomania, grandiosity, jealousy, persecution complex, somatic delusions*

*Conditions not covered in this chapter or in [Chapter 29](#).

Data from American Psychiatric Association: *Diagnostic and statistical manual of mental disorders*, ed 4, Washington, DC, 2000, American Psychiatric Association.

minutes and usually lasts for about 20 to 30 minutes.⁶ A person who has repeated panic attacks is described as having a panic disorder.

Epidemiology

Anxiety disorders constitute the most frequently found psychiatric problem in the general population. Simple phobia is the most common of the anxiety disorders (up to 25% of the population will experience a phobia); however, panic disorder is the most common anxiety disorder in people who seek medical treatment (lifetime prevalence of 3.5%).² Generalized anxiety disorder has a lifetime prevalence of 5% to 6%.⁶ PTSD has a lifetime prevalence of 5% to 10%, with a point prevalence of 3% to 4%.^{7,8} Panic disorder, phobic disorders, and obsessive-compulsive disorders occur more frequently among first-degree relatives of people with these disorders than in the general population.^{2,3}

Etiology

Anxiety represents a threatened emergence into consciousness of painful, unacceptable thoughts, impulses, or desires (anxiety may result from psychological conflicts of the past and present). These psychological conflicts or feelings stimulate physiologic changes that lead to clinical manifestations of anxiety.^{4,6} Anxiety disorders may occur in persons who are under emotional stress, in those with certain systemic illnesses, or as a component of various psychiatric disorders. Panic disorders tend to occur in families: First-degree relatives of a person with a panic disorder have about an 18% increased risk for development of a similar disorder.^{4,6}

The cause of panic disorder is unknown but appears to involve a genetic predisposition, altered autonomic responsivity, and social learning. Panic disorder shows a familial aggregation; the disorder is concordant in 30% to 45% of monozygotic twins, and genome-wide screens

have identified suggestive risk loci on 1q, 7p15, 10q, 11p, and 13q. Acute panic attacks appear to be associated with increased noradrenergic discharges in the locus coeruleus.⁸

No single theory fully explains all anxiety disorders. No single biologic or psychological cause of anxiety has been identified. Psychosocial and biologic processes together may best explain anxiety. The locus coeruleus, a brainstem structure that contains most of the noradrenergic neurons in the central nervous system (CNS), appears to be involved in panic attacks and anxiety. Panic and anxiety may be correlated with dysregulated firing of the locus coeruleus caused by input from multiple sources, including peripheral autonomic afferents, medullary afferents, and serotonergic fibers.³⁻⁵

Anxiety states also may be associated with organic diseases, other psychiatric disorders, use of certain drugs, hyperthyroidism, and mitral valve prolapse. Anxiety also is associated with mood disorders, schizophrenia, or personality disorders.^{2,3,5}

CLINICAL PRESENTATION

From a psychological perspective, *anxiety* can be defined as emotional pain or a feeling that all is not well—a feeling of impending disaster. The source of the problem usually is not apparent to persons with anxiety. The feeling is the same in anxious patients as that in patients with fear, but the latter are aware of what the problem is and why they are “fearful.”⁹

Physiologic reactions to anxiety and to fear are the same and are mediated through the autonomic nervous system. Sympathetic and parasympathetic components may be involved. Signs and symptoms of anxiety caused by overactivation of the *sympathetic* nervous system include increased heart rate, sweating, dilated pupils, and muscle tension. Signs and symptoms of anxiety resulting from stimulation of the *parasympathetic* system include urinary frequency and episodic diarrhea.^{2,3,5}

Most people periodically experience some degree of anxiety in one or more aspects of their lives. Anxiety can be a strong motivator; low levels of anxiety can increase attention and improve performance. Anxiety leads to dysfunction when it is constant, or it may result in episodes of extreme vigilance, excessive motor tension, autonomic hyperactivity, and impaired concentration. Anxiety is part of the clinical picture in many patients with psychiatric disorders. Patients with mood disorders, dementia, psychosis, panic disorder, adjustment disorders, and toxic and withdrawal states often report feelings of anxiety.^{2,3,5,10,11}

Phobias

Phobias consist of three major groups: agoraphobia, social, and simple. Agoraphobia is a fear of having distressful or embarrassing symptoms on leaving home. It often accompanies panic disorder. Social phobias may be specific,



FIG 28.1 A specific phobia is acrophobia, the fear of heights.

such as fear of public speaking, or general, such as fear of being embarrassed when with people. Simple phobias include fear of snakes, heights (Fig. 28.1), flying, darkness, and needles. The two phobias that may affect medical or dental care are needle phobia and claustrophobia, the latter during magnetic resonance imaging (MRI) or radiation therapy.⁵ Dental “phobia” is associated with more extreme anxiety than the “usual” level attending a visit to the dentist.¹² Previous frightening dental experiences are cited as the major cause. Patients may specifically fear the noise and vibration of the drill, the sight of the injection needle, and the act of sitting in the dental chair, and they may experience muscle tension, fast heart rate, accelerated breathing, sweating, or stomach cramps. True phobic neurosis about dental treatment is rare.¹²

Panic Attack

About 15% of patients who are seen by cardiologists come to the doctor because of symptoms associated with a panic attack. Onset usually is between late adolescence and the mid-30s, but it may occur at any age. A key feature of panic is the adrenergic surge, which results in the fight-or-flight response. This response is an exaggerated sympathetic response (Table 28.1). Panic attacks may be cued or uncued. An example of a cued attack is that occurring in a person who is fearful of flying. Many patients report that they are unaware of any life stressors preceding the onset of panic disorder; such attacks are classified as uncued. The major complication of repeated

TABLE 28.1 Anxiety, Panic Attack, Generalized Anxiety Disorder, and Posttraumatic Stress Disorder

Anxiety Disorder	Signs and Symptoms	Major Diagnostic Criteria
Anxiety	<p>Motor tension</p> <ul style="list-style-type: none"> • Trembling, twitching, or feeling shaky • Muscle tension, aches, or soreness • Restlessness • Easy fatigability <p>Autonomic hyperactivity</p> <ul style="list-style-type: none"> • Shortness of breath or smothering sensations • Palpitations or accelerated heart rate (tachycardia) • Sweating or cold, sweaty hands • Dry mouth • Dizziness or lightheadedness • Nausea, diarrhea, or other manifestation of abdominal distress • Flashes (hot flashes) or chills • Frequent urination • Trouble swallowing or “lump in throat” <p>Vigilance and scanning</p> <ul style="list-style-type: none"> • Feeling “keyed up” or on edge • Exaggerated startle response • Difficulty concentrating, or episodes in which the patient’s “mind goes blank” • Trouble falling or staying asleep • Irritability 	<p>Some of the signs and symptoms of anxiety may be noted in persons who are under the daily stresses of life.</p> <p>This form of anxiety can be helpful in the sense of focusing necessary attention on a specific task, such as a school examination, driver’s test, or athletic event.</p> <p>Anxiety becomes a negative factor when signs and symptoms are present for longer periods and start having an effect on the person’s emotional and physical well-being.</p>
Panic disorder	<p>Sudden onset of intense fear, arousal, and cardiac and/or respiratory symptoms without provocation (panic attack); often confused with systemic medical illness such as angina pectoris or epilepsy</p> <p>Symptoms of anxiety listed above</p> <p>Fear of dying</p> <p>Fear of “going crazy” or doing something uncontrolled</p>	<p>One or more panic attacks have occurred that were unexpected and were not triggered by situations in which the person was the focus of another’s attention.</p> <p>Either four attacks have occurred within a 4-week period, or one or more attacks have been followed by a period of at least 1 month of persistent fear of having another attack.</p>
Generalized anxiety disorder	<p>At least six of the symptoms of anxiety listed above must be present over a period of 6 months or longer.</p>	<p>Presence of unrealistic or excessive worry and apprehension about two or more life circumstances, for a period of 6 months or longer, during which the person has been bothered more days than not by these concerns</p>
Posttraumatic stress disorder (PTSD)	<p>Symptoms of PTSD arise only after an exceptionally threatening event that is outside the normal range of experience (e.g., combat, rape, attempted murder or torture, acts of terrorism, natural disasters):</p> <ul style="list-style-type: none"> • Marked irritability • Hyperarousal • Hypervigilance • Insomnia • Secondary drug and alcohol abuse is common. 	<p>Repeated reliving of trauma as daydreams, intrusive memories, flashbacks, or nightmares</p> <p>Persistent psychic numbness or “emotional bloating”</p> <p>Avoidance of thoughts about or reminders of the trauma, which may lead to marked detachment from personal involvement or relationships</p> <p>Symbols, anniversaries, or similar events often prompt exacerbation of symptoms.</p>

Data from Schiffer RB: Psychiatric disorders in medical practice. In Goldman L, Ausiello D, editors: *Cecil textbook of medicine*, ed 23, Philadelphia, Saunders, 2008; and Lucey JV, Corvin A: Anxiety disorders. In Wright P, Stern J, Phelan M, editors: *Core psychiatry*, ed 2, Edinburgh, Elsevier, 2005.

panic attacks is a restricted lifestyle adopted to avoid situations that might trigger an attack. Some patients develop agoraphobia, an irrational fear of being alone in public places, which can cause them to be housebound for years. Sudden loss of social supports or disruption of important interpersonal relationships appears to predispose the affected person to development of panic disorder.^{3,6,8}

Generalized Anxiety Disorder

Some patients present with a persistent, diffuse form of anxiety characterized by signs and symptoms of motor tension, autonomic hyperactivity, and apprehension (see [Table 28.1](#)). No familial or genetic basis for this *generalized anxiety disorder* has been found. Outcomes typically are better than those with panic disorder; however, the

persistent anxiety may lead to depression and substance abuse.^{3,5,6,8}

Posttraumatic Stress Disorder

Posttraumatic stress disorder is a syndrome of psychophysiological signs and symptoms that develop after exposure to a traumatic event outside the usual range of human experience, such as combat exposure, a holocaust experience, rape, or a civilian disaster such as a hurricane (Fig. 28.2) or eruption of a volcano (Fig. 28.3). The traumatic event may represent a serious threat to the person's life or physical integrity; a serious threat to the persons' children, spouse, or other loved ones; or sudden destruction of home or community; alternatively, it may result when the person views an accident or an act of physical violence that seriously injures or kills another person(s).^{2,3,5,6,8} Other experiences that have resulted in PTSD or are associated with increased risk for the disorder include child abuse,¹³ weaning from mechanical ventilation,¹⁴ traumatic experience of myocardial infarction,¹⁵ and loss of a close relative or loved one to cancer.¹⁶

Most men with PTSD have been in combat, and most women give a history of sexual or physical abuse. The three cardinal features of PTSD are hyperarousal; intrusive symptoms, or flashbacks to the initial trauma; and psychic numbing.^{2,3,5,6,8} PTSD may follow traumatic or violent events that are anticipated or not anticipated, constant or repetitive, natural or malevolent. For this reason, terrorist attacks often lead to PTSD¹⁷⁻²³ (Fig. 28.4). PTSD is further defined by onset of symptoms at least 6 months after the trauma, or a duration of more than 3 months (see Table 28.1).

Diagnostic criteria for PTSD consist of a history of a traumatic experience and reexperiencing of the event

through intrusive memories, disturbing dreams, "flashbacks," and psychological or physical distress in response to reminders of the event; another criterion is avoidance of things associated with the trauma (see Table 28.1). Signs and symptoms include sleep problems, irritability, trouble concentrating, hypervigilance, startle responses, and psychic numbing, seen as detachment from others, reduced capacity for intimacy, and decreased interest in sex.^{2-6,8} Avoidance and numbing appear to be the most specific symptoms for identification of PTSD.²⁴

Although women generally are given the diagnosis of PTSD more often than men, the rate of PTSD is higher among male veterans than among female veterans; however, some evidence suggests that the condition is underdiagnosed in female veterans.²⁰ Pereira²⁰ found that (1) men experienced higher levels of combat stress, (2) greater exposure to stress was associated with increased symptoms of PTSD, (3) men and women exposed to similar levels of stress were equally likely to experience PTSD symptoms, and (4) men were more likely to be given the diagnosis of PTSD. Unit cohesion may protect from PTSD regardless of the level of stress exposure.²³ Drug treatment of men and persons with combat trauma-induced PTSD (men and women) is less effective than that provided to other veteran women or women with civilian trauma-induced PTSD.¹⁹



FIG 28.2 Time lapse photo of Hurricane Andrew, which hit southern Florida in August 1992. During past years, a number of major hurricanes hit the United States. Hurricane Katrina, which hit the Gulf Coast states in August 2005, was the most destructive in recent history in terms of number of deaths and extent of property damage.



FIG 28.3 The 1980 eruption of Mount St. Helens resulted in an increased incidence of posttraumatic stress disorder among residents of the Pacific Northwest.



FIG 28.4 Attack on the Twin Towers of the World Trade Center in New York City on September 11, 2001. (Courtesy of Getty Images.)

Acute Stress Disorder

Acute stress disorder develops after exposure of the patient to a traumatic event, and specific signs and symptoms resemble those of PTSD. In acute stress disorder, however, symptoms are of shorter duration and emerge more rapidly after the trauma. The symptomatic reaction is limited to the period during which the stressful event is occurring and its immediate aftermath.^{5,6}

MEDICAL MANAGEMENT

Psychological, behavioral, and drug modalities are used to treat anxiety disorders. Psychological treatment involves psychotherapy, which, in general, is used in more severe cases. Behavioral treatment includes cognitive approaches (anxiety management, relaxation, and cognitive restructuring), biofeedback, hypnosis, relaxation imaging, desensitization, and flooding. Drug treatment includes the use of tricyclic antidepressants (TCAs), selective serotonin reuptake inhibitors (SSRIs), monoamine oxidase (MAO) inhibitors, benzodiazepines, antihistamines, β -adrenergic receptor antagonists, and sedative-hypnotics.^{2,3} The most commonly used drugs are the benzodiazepines and the SSRI buspirone, or a combination of medications (Table 28.2). Most patients benefit maximally from a combination of therapies such as cognitive therapy plus medication.^{2,3,5,6}

Systemic desensitization (whereby the patient is gradually exposed to the feared situation) and flooding (by which the patient is exposed directly to the anxiety-provoking stimulus) are techniques used in the treatment of phobias. Claustrophobia associated with MRI can be managed with a low dose of benzodiazepines and behavioral therapy.^{4,17,18}

TABLE 28.2 Drugs Used to Treat Patients With Anxiety and Panic Attacks

Drug Class	Drug	Trade Name	Comments
Sedative-hypnotics	Chloral hydrate	Noctel	Seldom appropriate
	Meprobamate	Miltown	Seldom appropriate
Antihistamines	Hydroxyzine	Atarax	Most useful at bedtime for associated sleep
	Diphenhydramine	Benadryl	Most useful at bedtime for associated sleep
Benzodiazepines	Lorazepam	Ativan	Also effective for generalized anxiety
	Diazepam	Valium	
	Triazolam	Halcion	Abuse potential with many of the benzodiazepines!
	Chlordiazepoxide	Librium	
	Temazepam	Restoril	
	Alprazolam	Xanax	
	Clorazepate	Tranxene	
	Flurazepam	Dalmane	Higher risk of abuse potential with flurazepam
	Oxazepam	Serax	
	Clonazepam	Klonopin	Long duration of action permits once-daily dosing
Beta-blockers	Buspirone	BuSpar	No dependence with prolonged use
	Zolpidem	Ambien	Most useful on an as-needed basis
	Propranolol	Inderal	Does not block the fear component of anxiety or panic

Data from Schiffer RB: Psychiatric disorders in medical practice. In Goldman L, Ausiello D, editors: *Cecil textbook of medicine*, ed 23, Philadelphia, Saunders, 2008, p 2633.

First-line treatment for PTSD consists of psychotherapy (exposure therapy, group therapy, patient and family education), cognitive-behavioral therapy, and eye movement desensitization and reprocessing (EMDR).²¹ EMDR is a newer, relatively novel treatment in which the patient focuses on movements of the clinician's finger while maintaining a mental image of the traumatic experience.²¹

Second-line treatment consists of a combination of psychotherapy and pharmacologic therapy.²¹ In cases with comorbid psychiatric disorders or with especially severe symptoms of PTSD, a combination of psychotherapy and pharmacologic treatment is recommended as the first line of treatment. The U.S. Food and Drug Administration has approved the SSRIs paroxetine and sertraline for the treatment of PTSD. Bupropion or other antidepressants are used when depression is a component of the clinical picture.

Benzodiazepines are used when anxiety is part of the symptom complex. Early intervention in patients with PTSD can shorten the duration and severity of anxiety.²¹ In some complex and treatment-resistant cases, mood stabilizers such as valproate or carbamazepine are indicated.²¹

EATING DISORDERS

DEFINITION

The two major eating disorders are anorexia nervosa and bulimia nervosa (Table 28.3). *Anorexia nervosa* is characterized by severe restriction of food intake, leading to weight loss and the medical sequelae of starvation (Fig. 28.5). *Bulimia nervosa* is characterized by attempts to restrict food intake but in a different form from that seen

TABLE 28.3 Clinical Findings and Epidemiology of Eating Disorders

Condition	Clinical Findings*	Epidemiology**
Anorexia nervosa	<p>Individual refuses to maintain a minimally normal body weight (the individual weighs less than 85% of the weight that is considered normal for the person's age and height)</p> <ul style="list-style-type: none"> • Intense fear of gaining weight or becoming fat • Significant disturbance in the perception of the shape or size of his or her body <p>Postmenarchal women with this disorder are amenorrheic The most obvious findings on physical examination is emaciation.</p> <p>There may also be hypotension, hypothermia, and dryness of skin.</p> <p>Most individuals with anorexia nervosa exhibit bradycardia.</p>	<p>Prevalence: 0.5%–3.7%</p> <p>Mean age at onset: bimodal, with peaks at 14 and 18 years</p> <p>Rare after 40 years of age</p> <p>Females, 90%–95% of cases</p> <p>More common in women in higher socioeconomic groups and among white women</p> <p>Mortality rate: 5%–20%</p> <ul style="list-style-type: none"> • Starvation • Suicide • Electrolyte imbalance
Bulimia nervosa	<p>Recurrent episodes of binge eating characterized by both of the following:</p> <ol style="list-style-type: none"> 1. Eating, in a discrete period of time (e.g., within any 2-hour period), an amount of food that is definitely larger than most people would eat during a similar period of time and under similar circumstances 2. A sense of lack of control over eating during the episode (e.g., a feeling that one cannot stop eating or control what or how much one is eating) <p>The binge eating and inappropriate compensatory behaviors both occur, on average, at least twice a week for 3 months.</p> <p>Recurrent inappropriate compensatory behavior to prevent weight gain, such as self-induced vomiting; misuse of laxatives, diuretics, enemas, or medications; fasting; or excessive weight gain.</p> <p>Self-evaluation is unduly influenced by body shape and weight.</p>	<p>Prevalence: 1.1%–4.2% of women and 0.1% of men develop the condition during their lifetimes</p> <p>Average age at onset: ≈20 years</p> <p>Females, 90%–95% of cases</p> <p>More than 30% abuse alcohol and stimulants.</p> <p>Half have personality disorders.</p> <p>Rates are similar in high- and lower income groups, but treatment is sought more often by women in higher income groups.</p> <p>Higher rate in white women, but more cases are beginning to appear in ethnic minority groups.</p> <p>Long-term outcome not known but appears to have a more optimistic prognosis than for anorexia nervosa; the death rate from anorexia nervosa due to cardiac arrest and suicide is much higher than the death rate for bulimia.</p>
Eating disorders not otherwise specified	<p>The eating disorder not otherwise specified category is for disorders of eating that do not meet the criteria for any specific eating disorder</p> <p>For example, for female patients, all the criteria for anorexia nervosa are met except that the individual has regular menses.</p>	<p>Difficult to establish the prevalence of this more newly recognized group of eating disorders</p>

*From American Psychiatric Association: Eating disorders. In Diagnostic and statistical manual of mental disorders, fourth edition, text rev, Washington, DC, American Psychiatric Association, 2000.

**Data from Franco KN: Eating disorders. In Carey WD, et al, editors: Current clinical medicine 2009 — Cleveland Clinic, Philadelphia, Saunders, 2009.



FIG 28.5 The 1995 bombing of the Alfred P. Murrah Federal Building in Oklahoma City, Oklahoma, resulted in a greater than 33% incidence of posttraumatic stress disorder among survivors. (Courtesy of NASA Ames Research Center, Disaster Assistance and Rescue Team, Mountain View, CA.)

in anorexia nervosa. In bulimia, attempts at restriction are interspersed with binge eating followed by various methods of trying to rid the body of food. These include induced vomiting (often by means of a finger in the throat or with syrup of ipecac), laxatives, and diuretics.²⁵⁻²⁷

Binge eating disorder (BED) is a more recently described syndrome characterized by repeated episodes of binge eating, similar to those of bulimia nervosa, in the absence of inappropriate compensatory behavior. Patients with BED typically are middle-aged men or women with significant obesity.^{28,29}

Epidemiology

These disorders cause psychological and physical morbidity in women (90%–95% of cases) and, to a much lesser extent, in men (5%–10% of cases).³⁰⁻³³ Anorexia nervosa affects an estimated 1% of women between 12 and 25 years of age.^{31,32} It is more common in white women and women from higher socioeconomic groups (see [Table 28.3](#)). The lifetime prevalence of anorexia nervosa among women ranges from 0.5% to 3.7%, depending on how the disease is defined.²⁷ The mean age at onset of anorexia nervosa is bimodal, with peaks at the ages of 14 and 18 years.³¹ Bulimia nervosa is more common than anorexia nervosa. Its prevalence among women range from 1.1% to 4.2%.²⁷ The average age at onset for bulimia nervosa

is about 20 years. In contrast with anorexia nervosa, bulimia nervosa occurs at about the same rate in higher and in lower income groups of women. It is more common in white women than in women of ethnic minority groups.³¹

Etiology

The cause of eating disorders is unknown. Genetic, cultural, and psychiatric factors appear to play a role in the origin of these disorders.^{27,28} In addition, primary dysfunction of the hypothalamus has been suggested to play a causative role in eating disorders. However, recognized hypothalamic abnormalities revert to normal with weight gain and thus appear to be secondary in nature.²⁸ Some evidence indicates that dysfunction in serotonin-mediated neurotransmission may contribute to the development of eating disorders.³² Elevated homocysteine levels have been reported in patients with eating disorders and may be involved in the pathophysiology of these conditions.³⁴ Lack of self-esteem appears to play an important role in eating disorders.³⁵ Genetic factors are recognized to contribute to the risk of development of anorexia nervosa: Its incidence is greater in families with one affected member, and the concordance in monozygotic twins is greater than in dizygotic twins. Specific genes, however, have not been identified.²⁸ Linkage studies have found an association of anorexia nervosa with chromosome 1 and an association of bulimia nervosa with chromosome 10.³²

Cultural issues are important in the origin of eating disorders. The quest for health and slimness is a powerful force in modern society and may reinforce the fear of being overweight in patients with an eating disorder or may tip the borderline case into overt disease. Certain hobbies and occupations (e.g., modeling, skating, gymnastics, wrestling, track, ballet dancing) that emphasize body shape, weight, and appearance also may play a role in eating disorders.²⁵⁻²⁸

CLINICAL PRESENTATION

Signs and Symptoms

The diagnosis of an eating disorder is made on clinical grounds, as set forth in [Box 28.2](#). The weight criterion for diagnosis of anorexia is 85% or less of expected ideal weight. An expressed intense fear of gaining weight or becoming fat, even when underweight, and a disturbance in body image complete the diagnostic triad.^{25-28,36} The diagnosis of bulimia is made with a history of binge eating without major weight gain, evidence of purging (induced vomiting or regular use of laxatives or diuretics), obsessive-compulsive behavior, and antisocial activity or self-mutilation.²⁵⁻²⁸

Anorexia nervosa usually begins around puberty but may appear later, usually by the mid-20s. Despite severe weight loss, patients deny hunger, thinness, or fatigue. They often are physically active and participate in ritualized

BOX 28.2 DSM-IV Diagnostic Criteria for Anorexia Nervosa and Bulimia Nervosa

Anorexia Nervosa

- A.** Refusal to maintain body weight at or above minimally normal weight for age and height (e.g., weight loss leading to maintenance of body weight less than 85% of that expected; or failure to make expected weight gain during period of growth, leading to body weight less than 85% of that expected)
- B.** Intense fear of gaining weight or becoming fat, even though underweight
- C.** Disturbance in the way in which one's body weight or shape is experienced, undue influence of body shape on self-evaluation, or denial of the seriousness of the current low body weight
- D.** In postmenarchal females, amenorrhea, i.e., the absence of at least three consecutive menstrual cycles. (A woman is considered to have amenorrhea if her periods occur only following hormone, e.g., estrogen, administration).

Specify Type

- **Restricting type:** During the current episode of anorexia nervosa, the person has not regularly engaged in binge eating or purging behavior (i.e., self-induced vomiting or misuse of laxatives, diuretics, or enemas).
- **Binge eating/purging type:** During the current episode of anorexia nervosa, the person has regularly engaged in binge eating or purging behavior (i.e., self-induced vomiting or misuse of laxatives, diuretics, or enemas).

Bulimia Nervosa

- A.** Recurrent episodes of binge eating; an episode of binge eating is characterized by both of the following:
 - (1)** Eating, in a discrete period of time (e.g., within any 2-hour period), an amount of food that is definitely larger than most people would eat during a similar period of time and under similar circumstances
 - (2)** A sense of lack of control over eating during the episode (e.g., a feeling that one cannot stop eating or control what or how much one is eating)
- B.** Recurrent inappropriate compensatory behavior in order to prevent weight gain, such as self-induced vomiting; misuse of laxatives, diuretics, enemas, or other medication; fasting; or excessive exercise
- C.** Binge eating and inappropriate compensatory behaviors both occur, on average, at least twice a week for 3 months.
- D.** Self-evaluation is unduly influenced by body shape and weight.
- E.** The disturbance does not occur exclusively during episodes of anorexia nervosa.

Specify Type

- **Purging type:** During the current episode of bulimia nervosa, the person has regularly engaged in self-induced vomiting or the misuse of laxatives, diuretics, or enemas.
- **Nonpurging type:** During the current episode of bulimia nervosa, the person has used other inappropriate compensatory behaviors, such as fasting or excessive exercise, but has not regularly engaged in self-induced vomiting or the misuse of laxatives, diuretics, or enemas.

DSM, *Diagnostic and statistical manual of mental disorders*, fourth edition.

Data from American Psychiatric Association: *Diagnostic and statistical manual of mental disorders*, ed 4, Washington, DC, 2000, American Psychiatric Association.

exercise. Constipation and cold intolerance are common. Amenorrhea usually accompanies or comes after weight loss. In advanced cases, bradycardia, hypothermia, and hypotension occur. Little or no body fat is evident, and bony protrusions (e.g., at the hips or shoulder blades) are pronounced. The parotid glands may become enlarged. The skin may be dry and scaly and often is yellow because of carotenemia. Patients with eating disorders may show other dermatologic abnormalities; alopecia, xerosis, hypertrichosis, and nail fragility may be clinical manifestations of starvation.²⁵⁻²⁸ Peripheral edema may occur in up to 20% of adolescent patients with anorexia nervosa and can be misinterpreted as weight gain by the patient, making acceptance of treatment difficult.³⁷

Patients with bulimia (“ox-hunger”) nervosa engage in episodic, compulsive ingestion of large amounts of food (see Box 28.2). They are aware that this eating is abnormal; they have a fear that they cannot stop eating and have feelings of depression at the completion of eating. Patients with bulimia also have a morbid fear of becoming fat. Secrecy about the eating–vomiting sequence is common. Episodes of binge eating are followed by vomiting induced by means of a finger or another object, or with a drug

such as ipecac, with or without subsequent ingestion of laxatives or diuretics. Bloating, constipation, esophagitis, abdominal pain, and nausea are common. Binge eating generally occurs daily; large amounts of food, usually high-carbohydrate foods such as ice cream, bread, candy, and doughnuts, are consumed during each episode. Dental caries becomes a problem because of the high carbohydrate content of the diet.²⁵⁻²⁸

Laboratory Findings

The serum amylase has been reported to be elevated in 45% of bulimic patients.³⁸ In the same study, serum amylase was found to be elevated in pregnant women with hyperemesis but not in nonvomiting pregnant women. The authors of the study³⁸ concluded that vomiting, rather than binge eating, increases serum amylase in patients with bulimia. They speculated that increased amylase came from the salivary gland. Another study^{39,40} found that parotid gland size was enlarged in 36% of patients with bulimia and was correlated with frequency of bulimic symptoms and with serum amylase concentrations.

Patients with anorexia nervosa are vulnerable to sudden death from ventricular tachyarrhythmias. The risk of death

becomes greater when weight declines to below 35% of ideal weight. Complications of bulimia include aspiration of vomitus, esophageal or gastric rupture, hypokalemia with cardiac arrhythmias, pancreatitis, and ipecac-induced myopathy and cardiomyopathy.²⁵⁻²⁸

Long-term follow-up evaluation of patients with anorexia nervosa shows recovery rates of 44% to 76%, with a recovery time of 57 to 59 months. Mortality rates of up to 20% have been reported, with cardiac arrest and suicide the primary causes of death.²⁷ The long-term mortality associated with anorexia nervosa is among the highest for any psychiatric disorder.⁴¹ Approximately 5% of patients die per decade of follow-up, primarily from the physical effects of chronic starvation or by suicide.²⁸ Long-term follow-up data for bulimia nervosa are less comprehensive. Short-term success rates range from 50% to 70%, with relapse rates between 30% and 50% after 6 months. Patients with bulimia nervosa have an overall better prognosis than those with anorexia nervosa.²⁷

The treatment of anorexia nervosa cannot proceed in a meaningful way in the absence of weight gain. The patient's nutritional status and medical stability are first evaluated. Patients with electrolyte disturbances or with abnormalities on electrocardiography may require hospitalization. When the patient is medically stable, psychiatric treatment can begin.^{42,43} Behavior modification techniques are used to assist the patient in weight gain.⁴⁴ The efficacy of psychotherapy has not been established but may have a role.⁴³ A recent report showed that yoga may be an effective adjunctive treatment for eating disorders.^{45,46} Drug therapy (antipsychotics, cyproheptadine, antidepressants) has not significantly improved the outcomes for patients with anorexia nervosa. The antidepressant fluoxetine has been shown to be useful in preventing relapse in patients who have gained back their weight.²⁶⁻²⁸ Brain-related therapy has been introduced and may play a role in the treatment of anorexia nervosa.⁴⁷

Antidepressant medication, cognitive-behavioral therapy, and interpersonal therapy all are effective in bulimia nervosa. Most patients are treated on an outpatient basis. Patients with medical complications such as extreme electrolyte imbalance or severe bulimic symptoms may require hospitalization.²⁶⁻²⁸ The supportive care of a knowledgeable but sympathetic physician also may be helpful for patients with bulimia. Attempts should be made to stop the gorging-regurgitation cycle, or at least to limit the load of food ingested, to minimize the chance of aspiration or gastric rupture. Potassium supplementation may be needed in patients who vomit and in those who use laxatives.²⁶⁻²⁸

MEDICAL MANAGEMENT

Benzodiazepines are used to treat various anxiety states (see Table 28.2). These drugs selectively but indirectly enhance γ -aminobutyric acid (GABA) neurotransmission.

The mechanism for this effect may involve an increase in neuronal receptor sensitivity to GABA. The benzodiazepines are very effective for short-lived reactive states of tension and anxiety and are the drugs of choice for generalized anxiety disorder. TCAs and MAO inhibitors are the drugs of choice for the management of panic disorders. Benzodiazepines are used for the treatment of anticipatory anxiety associated with panic disorder. They also are used in the treatment of other forms of anxiety associated with panic disorder and for anxiety symptoms in patients with phobic disorder.^{2,3,5}

Diazepam is the standard agent for antianxiety therapy. No other anxiolytic drug has shown better antianxiety efficacy. Treatment with anxiolytic drugs should continue for a period of only 4 weeks or less. To avoid the development of drug tolerance, these agents often are given for 7 to 10 days; a 2- to 3-day period without the drug follows. An early sign of drug tolerance is the requirement for increased dosage to obtain the same effects. Signs and symptoms of drug withdrawal include muscle aches, agitation, restlessness, insomnia, confusion, delirium, and, on rare occasion, grand mal seizures. Some patients may experience rebound anxiety after the drug has been stopped.^{8,21,48,49}

Adverse effects of the benzodiazepines include daytime sedation, mild cognitive impairment, and aggressive and impulsive behavioral responses. Use of any of this group of agents, which can potentiate the CNS effects of opioids, barbiturates, and alcohol, is hazardous or is contraindicated in the following groups of patients: those who drive or operate machinery, patients with depressive mood disorders or psychosis, moderate to heavy drinkers, pregnant women, and elderly persons. Tolerance and habitual and physical dependence may occur with therapeutic doses. Actions of the benzodiazepines are additive and usually are synergistic with psychotropic agents. Drug interactions have been reported with cimetidine and erythromycin.^{8,21,48,49}

Buspirone has mixed agonist-antagonist actions at serotonergic receptors that are thought to be involved in anxiety. It appears to have anxiolytic effects that are comparable with those of benzodiazepines, without sedative, anticonvulsant, or muscle relaxant effects. These anxiolytic effects are delayed in onset, taking up to 3 weeks before becoming clinical obvious. The drug is recommended for short-term use only. At this time, buspirone is not a first-line drug for the treatment of anxiety.^{8,21,48,49}

Several tricyclics and other antidepressants have additional sedative or anxiolytic effects. They appear to be as effective as benzodiazepines for generalized anxiety and superior for panic disorder and agoraphobia. SSRIs and MAO inhibitors also are effective in phobic states and panic disorders.²³ Disadvantages of these drugs include slow rate of onset of effect, potential for initial exacerbation of anxiety symptoms, toxicity in overdose, and numerous adverse effects.^{8,21,48}

DENTAL MANAGEMENT

Patients' Attitudes Toward Dentists

Childhood experiences and learned social roles of the patient are important factors in the development of feelings and attitudes toward dentists. Children learn role expectations through the teachings of physicians, dentists, parents, and peers. The patient may come to believe that the physician and the dentist are powerful and dangerous, eliciting feelings of awe and envy. Other emotions, attitudes, and behaviors associated with the patient's relationships with one or both parents also may be transferred to the dentist. Those of respect and politeness can be helpful. By contrast, those associated with a need for unending love, a demand for unceasing attention, and feelings of resentment and hate can be destructive. The dentist can take steps to help deflect such unrealistic expectations and inappropriate behaviors. From the initial patient encounter, maintaining a respectful, genuine, and open demeanor is less likely to encourage misplaced attitudes and feelings. In addition, these and related issues should be open for discussion between the dentist and the patient to clarify any impediments to development of a solid relationship.

MEDICAL MANAGEMENT

Anxiety

Anxiety related to dental treatment is fairly common. Severe dental fear or anxiety, however, is far less common. The origin of this anxiety may lie in negative personal dental experiences or in cognitive perceptions of what it may be like to go to the dentist. Armfield, in a study of Australian adult dental patients, found that the patients' perceptions were stronger predictors of dental fear than negative dental experiences.⁵⁰ In another study, Fuentes and associates concluded that dental anxiety is specific, with its own features and is not necessarily associated with so-called trait anxiety.⁵¹ Van Wijk and Hoogstraten reported that pain felt during dental injections is dependent on dental anxiety, fear of dental pain, fear of the injection, and the amount of injection fluid.⁵² Binkley and colleagues reported that dental care-related anxiety, fear of dental pain, and avoidance of dental care may be influenced by genetic variations such as red hair color (caused by variants of the melanocortin-1 receptor gene).⁵³ By taking a comprehensive dental history (including negative dental experiences and the patient's perception of dental treatment) and observing the patient for signs of anxiety, the dentist can identify patients who may need additional supportive care during dental treatment.

The dentist may detect anxiety in persons by observing their physical appearance, speech, and dress and checking for the presence of certain signs and symptoms. An anxious person looks overly alert and exhibits various restless-appearing postures and behaviors such as sitting forward in a chair; moving fingers, arms, or legs; getting up and

moving; pacing around the room; checking certain portions of clothing; straightening ties or scarves; and so forth. Conversely, sloppy dress habits and other signs that convey just the opposite of a concern with perfection may be seen instead. Anxious persons may appear especially watchful of their possessions, always trying to keep them in sight.⁹

An anxious person may speak mechanically and rapidly and at times may seem to block out or not connect thoughts. An anxious person may respond quickly, often not allowing the dentist to finish a question.⁹

Sweating, tension in the muscles, increased breathing, and rapid heart rate are other frequent manifestations of anxiety. The patient may report an inability to sleep or may awaken at an early hour and not be able to go back to sleep. Attacks of diarrhea and increased frequency of urination are common. In general, anxious persons are overly alert and tense, feel apprehensive, and have a sense of impending disaster that has no apparent cause. Insomnia, tension, and apprehension lead to fatigue, which may further impair efforts to deal with anxiety or its causes.⁹

In interactions with the patient, the dentist should convey an appropriate level of personal interest. Verbal and nonverbal components of communication must be consistent (Box 28.3). An often helpful approach is to begin by mentioning that the patient appears anxious and then to inviting the patient to talk about relevant feelings, which may include attitudes toward the dentist. During these discussions, tension-free pauses between expressions of ideas should be permitted, allowing a temporary state of regression to occur that will help the patient to restore a more anxiety-free state. Some patients may respond well to this approach without ever indicating why they were anxious.⁹

If a patient remains anxious, the dentist may elect to use hypnosis, oral or parenteral sedation agents, or nitrous oxide plus oxygen to better manage the dental treatment (see Box 28.3). A recent study demonstrated a beneficial effect of acupuncture on the level of anxiety in patients with dental anxiety.⁵⁴

Anxiety or a history of panic attacks also may be associated with mitral valve prolapse.^{4,6,55} In the past, patients with mitral valve prolapse and valvular regurgitation were given antibiotic prophylaxis for invasive dental procedures. In accordance with the 2007 American Heart Association guidelines, these patients no longer require prophylaxis (see Chapter 2).

Patients with uncontrolled hyperthyroidism also may experience increased levels of anxiety; in such patients, therefore, it is important to avoid the use of epinephrine, including even the small amounts present in local anesthetics (see Chapter 16). Patients who display signs and symptoms of hyperthyroidism should be referred for medical evaluation and treatment.⁵⁶

Posttraumatic Stress Disorder

Veterans with PTSD may view the dentist as a representative authority figure who misled them and sent them to

BOX 28.3 Dental Management Considerations in Anxious Patients**P****Patient Evaluation and Risk Assessment (See Box 1.1)**

- Evaluate to determine whether anxiety is present.
- Obtain medical consultation if clinical signs and symptoms point to an undiagnosed problem or if diagnosis is uncertain.

Potential Issues and Factors of Concern**A**

Analgesics	The control of postoperative pain is extremely important in anxious patients. In accordance with the procedure performed, the dentist should select the most appropriate drug for pain control (NSAIDs, salicylates, acetaminophen, codeine, oxycodone, fentanyl, morphine, and others). Also, adjunctive medications such as antidepressants, muscle relaxants, steroids, and antibiotics may be indicated.
Antibiotics	Not indicated unless acute infection is present.
Anesthesia	Effective local anesthesia is essential, and oral sedation is provided on the night before and just before the dental appointment with a fast-acting benzodiazepine (alprazolam, 0.5-mg tablet; diazepam, 2-, 5-, or 10-mg tablet; or triazolam, 0.125- or 0.25-mg tablet) aids in the management of anxiety in a majority of cases. For more anxious patients, inhalation sedation with nitrous oxide, intramuscular sedation (midazolam, promethazine, or meperidine), or IV sedation (diazepam, midazolam, or fentanyl) can be used.
Anxiety	Establish effective communication; maintain an open and honest demeanor with appropriate level of genuine personal revelation; be consistent in verbal and nonverbal components of communication; provide explanations of procedures with short “question-and-answer” breaks to address the patient’s concerns; and finally, if discomfort is anticipated, reassure the patient that all possible measures for a “pain-free” procedure will be used. If the patient appears overly anxious, confirmation of or attentiveness to this distress may be helpful (e.g., “You seem tense today—would you like to talk about it?”). During the procedure, it is important to signal the patient when any discomfort may be expected and to let the patient know that things are going well. Advise the patient beforehand of what usually occurs after the procedure, what drugs and measures will be prescribed to minimize any discomfort, and any activities or medications to be avoided. Describe any complications that could occur, such as pain, bleeding, infection, or allergic reactions to any medications that may have been prescribed. Instruct the patient to contact the dental office if any complication occurs or, in the event of severe bleeding or allergic reaction, to go to the nearest hospital emergency department.

B

Bleeding	No issues
Breathing	No issues
Blood pressure	No issues

C

Chair position	No issues
Cardiovascular	Many patients experiencing a panic attack think that they are having a heart attack.
Consultation	With severe anxiety associated with any of the anxiety states such as PTSD or panic disorder, the patient’s physician should be consulted regarding any special management considerations.

D

Devices	No issues
Drugs	No issues

E

Equipment	No issues
Emergencies	Patients with PTSD who make comments about suicidal thoughts should be referred for psychiatric care.

F

Follow-up	Routine follow-up evaluation is recommended.
-----------	--

war.⁹ They may associate dental treatment with loss of control; hence, the dentist must attempt to establish communication and trust with these patients. Patients with intravenous drug habits may be carriers of the hepatitis B virus (hepatitis B surface antigen positive) and of human immunodeficiency virus (HIV). Those who are heavy drinkers may have liver and bone marrow involvement and may be at increased risk for infection, excessive bleeding, delayed healing, and altered drug metabolism. During the depressive stage of PTSD, patients often show a total disregard for oral hygiene procedures and are at increased risk for development of dental caries, periodontal disease, and pericoronitis. They may report atypical facial pain, glossodynia, temporomandibular joint (TMJ) disorder, and bruxism.⁹

Stress-Related Disorders

Oral diseases that are thought to have a psychological component in their clinical presentation (the older term was *psychophysiologic disorders*) include aphthous ulcers, lichen planus, TMJ dysfunction, myofascial pain, and geographic tongue. Examples of some of these lesions are shown in Figs. 28.6 to 28.10.

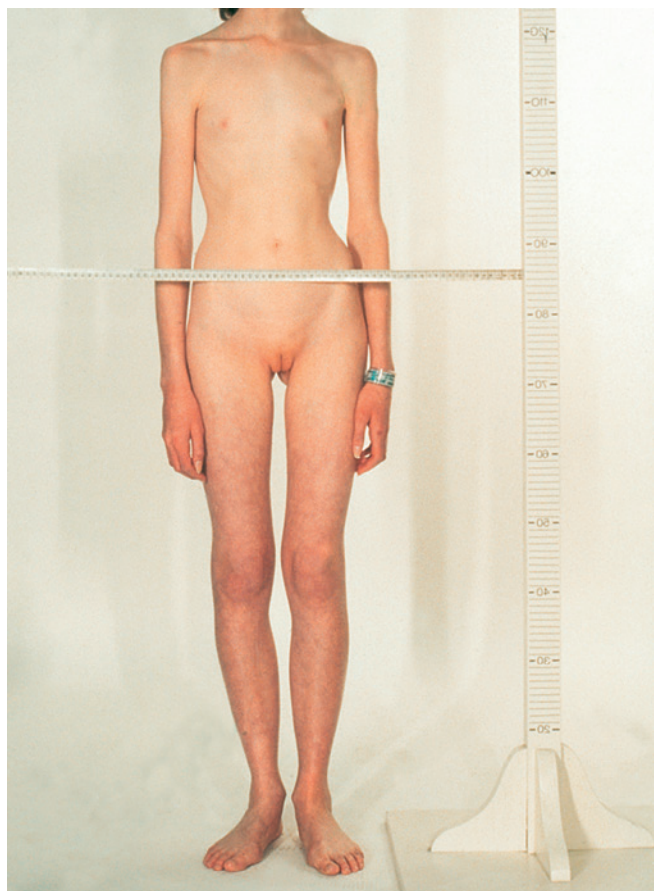

FIG 28.6 Anorexia nervosa in a young woman. Note the low body weight and the preservation of breast tissue. (From Moshang T: *Pediatric endocrinology: the requisites in pediatrics*, St. Louis, 2005, Mosby.)

In these disorders, an identifiable lesion with an emotional component is part of the clinical presentation. The pathologic process is potentially dangerous to the patient. The disorder does not reduce the level of anxiety or depression but rather increases it, and increased anxiety or depression can aggravate the condition. These disorders can be treated through the regimen provided in Appendix C. The anxious patient can be sedated with the use of one of the agents shown in Box 28.3. Patients with atypical facial pain, TMJ dysfunction, or myofascial pain often are treated with an antidepressant medication.

Eating Disorders

The main task of the dentist in the management of patients with bulimia nervosa is to deal with the results of improper diet (dental caries) and the effects of chronic vomiting on the teeth (erosion).⁵⁷ One study⁵⁸ found that the average pH of vomitus was 3.8; chronic exposure can therefore lead to severe erosion of teeth. The dentist has an important public health role as a case finder. On the dental examination, the finding of a pattern of tooth erosion that is consistent with habitual regurgitation of stomach contents may be the first indication of the presence of an

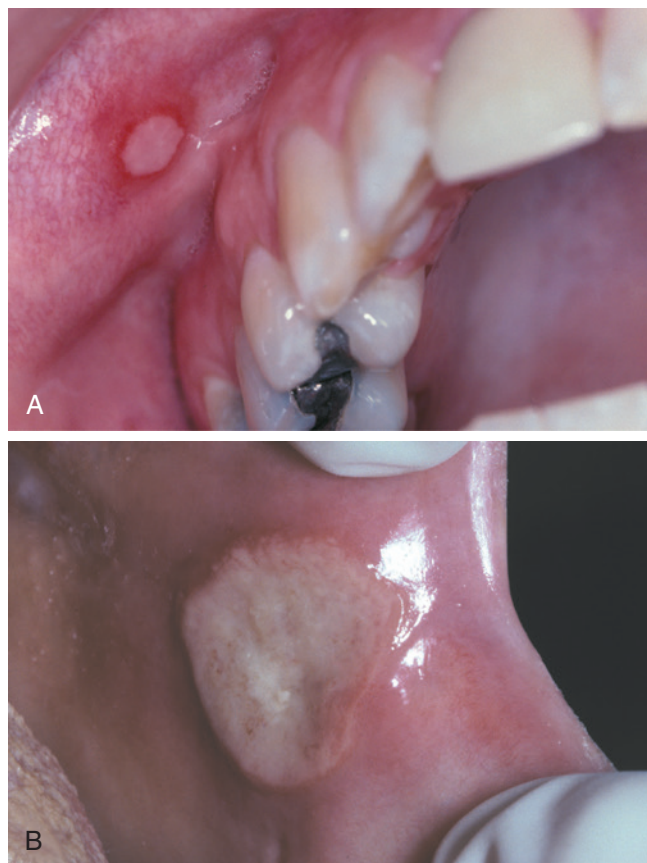

FIG 28.7 **A**, A single minor aphthous ulceration of the anterior buccal mucosa. **B**, A large major aphthous ulceration of the left anterior buccal mucosa (From Neville BW, Damm DD, Allen CM, Bouquot J: *Oral and maxillofacial pathology*, ed 3, Philadelphia, 2009, Saunders.)



FIG 28.8 **A**, Lichen planus on the skin of the wrist. **B**, Lichen planus on the buccal mucosa. (From Neville BW, Damm DD, Allen CM, Bouquot J: *Oral and maxillofacial pathology*, ed 3, Philadelphia, 2009, Saunders.)

eating disorder (see Fig. 28.9). Subsequent referral can lead to medical diagnosis and appropriate treatment; however, patients often deny the pathologic behaviors. The erosive pattern involves the lingual surfaces of the teeth, primarily the maxillary teeth because the tongue protects the mandibular teeth. This particular type of erosion is known as *perimyolysis*. In some cases, erosion also can affect the occlusal surfaces of molar and premolar teeth, where the process can be accelerated by attrition.⁵⁰⁻⁵² The potential for serious medical complications of bulimia nervosa (gastric rupture, esophageal tears, cardiac arrhythmia, and death) must be pointed out to the patient, along with the fact that these can be avoided with proper medical and psychological therapy.^{32,59,60}

The diet of some patients with bulimia is rich in carbohydrates and carbonated liquids, which can lead to extensive dental caries and additional erosion of the teeth. An increase in dental caries most often is seen in patients with poor oral hygiene. Accordingly, an important goal of dental care is to improve oral hygiene practices.⁵⁷ To this end, the dentist should provide instruction on tooth-brushing, use of dental floss, and application of topical fluoride. The patient is instructed to use a baking soda



FIG 28.9 Geographic tongue (benign migratory glossitis, erythemia migrans) consists of erythematous, well-demarcated areas of papillary atrophy, with a tendency to involve the lateral aspects of the tongue. (From Neville BW, Damm DD, Allen CM, Bouquot J: *Oral and maxillofacial pathology*, ed 3, Philadelphia, 2009, Saunders.)



FIG 28.10 **A**, Lingual erosion of enamel in a patient with bulimia caused by regurgitation of stomach contents. **B**, Labial erosion of enamel in a patient who habitually sucked on citrus products.

mouth rinse and to brush the teeth after induced vomiting.⁵⁷ Tooth sensitivity can be managed with the use of desensitizing toothpastes, fluoride applications, and other means.⁵⁷

Patients with anorexia nervosa may be difficult to identify and deal with in a dental practice. About 40% to 50% of patients with anorexia nervosa also are bulimic and may show dental signs of bulimia.^{32,60} Young patients who appear to be anorexic should be confronted about the weight loss. If the initial examination and history reveal no evidence of serious medical disease such as cancer or diabetes mellitus, the possibility of self-starvation should be discussed with the patient. Serious medical complications of anorexia nervosa, including death (reported mortality rates are as high as 15% to 20%), must be discussed in a straightforward manner. Again, when young patients are involved, parents must be informed. Every attempt should be made to refer patients to a physician for evaluation and treatment.

Management of Drug Interactions

The potential for clinically significant drug interactions between benzodiazepines—the mainstay of treatment for anxiety—and barbiturates, opioids, psychotropic agents, cimetidine, and erythromycin is well recognized. In general, these agents potentiate the CNS depressant effects of benzodiazepines. Regarding the concomitant use of these agents and benzodiazepines, two situations are of clinical concern in dental treatment:

- Barbiturates (not used often now in dentistry) and opioids used for dental sedation or pain control must be administered with caution and in decreased dosages in patients who are taking a benzodiazepine for an anxiety disorder.
- The dentist may prescribe a benzodiazepine for sedation to control dental treatment–related anxiety, but care must be taken with use of these drugs in patients receiving psychotropic agents for a psychiatric disorder.

Usually, the dosage of the medication can be reduced to avoid overdepression of the CNS. The dentist should consult with the patient's physician before using these drug combinations. During treatment, the patient can be monitored with the use of a pulse oximeter.^{7-9,61}

Treatment Planning Considerations

Goals of treatment planning for patients with psychiatric disorders are to maintain oral health, comfort, and function and to prevent and control oral disease. Without an aggressive approach to prevention, the incidence of dental caries and periodontal disease can be expected to increase. Susceptibility to these problems stems from the adverse effects of xerostomia associated with most of the medications used in treatment, coupled with the characteristically reduced interest in or impaired ability

to perform oral hygiene procedures seen in many of these psychiatric disorders. In addition, the diet of persons with such disorders often contains significant amounts of foods or drinks associated with increased risk for dental disease.^{9,62}

The dental treatment plan should contain the following elements: (1) Daily oral hygiene procedures must be identified, (2) the treatment plan must be realistic in terms of the patient's psychiatric disorder and physical status, and (3) the plan must be dynamic to take into account changes in the acuity or severity of the psychiatric disorder and in the patient's physical status.⁶³

The dental team should communicate to the patient and family members a positive, hopeful attitude toward maintenance of the patient's oral health. The dental team should determine whether the patient is legally able to make rational decisions. This should be discussed with the patient and a loved one. Treatment planning often involves input and permission from a loved one so that decisions can be made.⁶³

The last aspect of the treatment plan deals with the selection of medications to be used in providing dental treatment to the patient. Some agents may have to be avoided; others may require a reduction in the usual dosage. Medical consultation is suggested to establish the patient's current status, ascertain the medications the patient is taking, identify complications that may be present, and confirm dental medications and doses that will minimize possible drug interactions.⁶³

In patients with bulimia, complex restorative procedures should not be planned until the gorging and vomiting cycle has been broken. In a few cases, crowns may be required in an attempt to save teeth. When the patient's overall health status is stable, restoration of teeth with severe erosion can begin. The dentist and the patient must be aware, however, that relapse is common and that complex restorations may fail with recurrence of chronic vomiting.⁵⁷ Fortunately, with the development of resin composite and adhesive systems, it is now possible to reconstruct damaged teeth with minimal dental preparation and with less expense. Thus, it has become more practical to restore teeth even when the pathologic vomiting has not yet been curtailed.⁶⁴

Oral Complications and Manifestations

Patients with bulimia may present with severe erosion of the lingual and occlusal surfaces of the teeth (see Fig. 28.9). Severe erosion can be associated with increased tooth sensitivity to touch and to cold temperature. Dental caries may be more prevalent among these patients. The amount of saliva produced may be decreased. Patients often report dry mouth. Those with poor oral hygiene exhibit increased periodontal disease. The parotid gland may become enlarged. Patients with anorexia nervosa also may demonstrate decreased salivary flow, dry mouth, atrophic mucosa, and an enlarged parotid gland.⁵⁷

REFERENCES

- American Psychiatric Association. *Diagnostic and Statistical Manual of Mental Disorders (DSM-5TM)*. 5th ed. Arlington, VA: American Psychiatric Publishing; 2013:1-947.
- Rowney J. Anxiety disorders. In: Carey WD, ed. *Current Clinical Medicine 2009 - Cleveland Clinic*. Philadelphia: Saunders Elsevier; 2009:983-988.
- Schiffer RB. Psychiatric disorders in medical practice. In: Goldman L, Ausiello D, eds. *Cecil Medicine*. 23rd ed. Philadelphia: Saunders Elsevier; 2008:2628-2638.
- Vogel LR, Muskin PR. Anxiety Disorders. In: Cutler JL, Marcus ER, eds. *Saunders Text and Review Series: Psychiatry*. Philadelphia: W.B. Saunders Company; 1999:105-127.
- Reus VI. Mental disorders. In: Fauci AS, ed. *Harrison's Principles of Internal Medicine*. 17th ed. New York: McGraw-Hill; 2008:2710-2723.
- Association AP. *Anxiety Disorders. Diagnostic and Statistical Manual of Mental Disorders (DSM-IV-TR)*. 4th ed. Washington DC: American Psychiatric Association; 2000:429-485.
- Reus VI. Mental Disorders. In: Kasper DL, Braunwald E, Fauci AS, et al, eds. *Harrison's Online Principles of Medicine*. 16th ed. New York: McGraw-Hill; 2005:2547-2562.
- Saver DF, Ferri FF, Pearson RL, et al Anxiety. Elsevier 2006; 2006. <http://www.firstconsult.com/anxiety>. Accessed 25 March 2006.
- Little JW. Anxiety disorders: dental implications. *J Gen Dent*. 2003;51(6):562-570.
- Pollack EF, Baustian GH, Jones RC, et al Schizophrenia. Elsevier 2006; 2006. <http://www.firstconsult.com/schizophrenia>. Accessed 26 March 2006.
- Schenger J, Sudak D, Alici-Evciment Y. Depression. Elsevier 2006; 2006. <http://www.firstconsult.com/depression>. Accessed 25 March 2006.
- Scully C, Cawson RA. *Medical Problems in Dentistry*. 5th ed. Edinburgh: Elsevier (Churchill Livingstone); 2005.
- Canton-Cortes D, Canton J. Coping with child sexual abuse among college students and post-traumatic stress disorder: the role of continuity of abuse and relationship with the perpetrator. *Child Abuse Negl*. 2010;34(7):496-506.
- Jubran A, Lawm G, Duffner LA, et al. Post-traumatic stress disorder after weaning from prolonged mechanical ventilation. *Intensive Care Med*. 2010;36(12):2030-2037.
- Hari R, Begre S, Schmid JP, et al. Change over time in posttraumatic stress caused by myocardial infarction and predicting variables. *J Psychosom Res*. 2010;69(2):143-150.
- Elklit A, Reinholt N, Nielsen LH, et al. Posttraumatic stress disorder among bereaved relatives of cancer patients. *J Psychosoc Oncol*. 2010;28(4):399-412.
- Judd LL, Britton KT, Braff DL. Mental disorders. In: Isselbacher KJ, Braunwald E, et al, eds. *Harrison's Principles of Internal Medicine*. 13th ed. New York: McGraw-Hill, Inc.; 1994:2400-2420.
- Goldberg RJ. *Practical Guide to the Care of the Psychiatric Patient*. St. Louis: Mosby; 1995.
- Davis LL, English BA, Ambrose SM, et al. Pharmacotherapy for post-traumatic stress disorder: a comprehensive review. *Expert Opin Pharmacother*. 2001;2(10):1583-1595.
- Pereira A. Combat trauma and the diagnosis of post-traumatic stress disorder in female and male veterans. *Mil Med*. 2002;167(1):23-27.
- Kabongo ML, Jones RC, Stangler RS, et al Posttraumatic Stress Disorder. Elsevier 2006; 2006. <http://www.firstconsult.com/posttraumaticstressdisorder>. Accessed 25 March 2006.
- Healy D. *Psychiatric Drugs Explained*. 5th ed. St. Louis: Churchill Livingstone Elsevier; 2009.
- Dickstein BD, McLean CP, Mintz J, et al. Unit cohesion and PTSD symptom severity in Air Force medical personnel. *Mil Med*. 2010;175(7):482-486.
- North CS, Suris AM, Davis M, et al. Toward validation of the diagnosis of posttraumatic stress disorder. *Am J Psychiatry*. 2009;166:34-41.
- Association AP. Eating disorders. In: *Diagnostic and Statistical Manual of Mental Disorders (DSM-IV-TR)*. 4th ed. Washington DC: American Psychiatric Association; 2000:583-597.
- Marcus DM. Eating disorders. In: Goldman L, Ausiello D, eds. *Cecil Medicine*. 23rd ed. Philadelphia: Saunders Elsevier; 2008:1640-1642.
- Franco KN. Eating disorders. In: Carey WD, ed. *Current Clinical Medicine 2009 - Cleveland Clinic*. Philadelphia: Saunders Elsevier; 2009:1013-1018.
- Walsh BT. Eating disorders. In: Fauci AS, ed. *Harrison's Principles of Internal Medicine*. 17th ed. New York: McGraw-Hill; 2008:473-478.
- Simon JJ, Skunde M, Walther S, et al. Neural signature of food reward processing in bulimic-type eating disorders. *Soc Cogn Affect Neurosci*. 2016.
- Redston S, Tiller J, Schweitzer I, et al. 'Help us, she's fading away': How to manage the patient with anorexia nervosa. *Aust Fam Physician*. 2014;43(8):531-536.
- West DS. The eating disorders. In: Goldman L, Ausiello D, eds. *Cecil Textbook of Medicine*. Philadelphia: Saunders; 2004:1336-1338.
- Majid SH, Treasure JL. Eating disorders. In: Wright P, Stern J, Phelan M, eds. *Core Psychiatry*. 2nd ed. Edinburgh: Elsevier; 2005:217-241.
- Sabel AL, Rosen E, Mehler PS. Severe anorexia nervosa in males: clinical presentations and medical treatment. *Eat Disord*. 2014;22(3):209-220.
- Wilhelm J, Muller E, de Zwaan M, et al. Elevation of homocysteine levels is only partially reversed after therapy in females with eating disorders. *J Neural Transm*. 2010;117(4):521-527.
- Vanderlinden J, Kamphuis JH, Slagmolen C, et al. Be kind to your eating disorder patients: the impact of positive and negative feedback on the explicit and implicit self-esteem of female patients with eating disorders. *Eat Weight Disord*. 2009;14(4):e237-e242.
- Metral M, Guardia D, Bauwens I, et al. Painfully thin but locked inside a fatter body: abnormalities in both anticipation and execution of action in anorexia nervosa. *BMC Res Notes*. 2014;7:707.

37. Derman O, Kilic EZ. Edema can be a handicap in treatment of anorexia nervosa. *Turk J Pediatr.* 2009;51(6):593-597.
38. Robertson C, Millar H. Hyperamylasemia in bulimia nervosa and hyperemesis gravidarum. *Int J Eat Disord.* 1999;26(2):223-227.
39. Metzger ED, Levine JM, McArdle CR, et al. Salivary gland enlargement and elevated serum amylase in bulimia nervosa. *Biol Psychiatry.* 1999;45(11):1520-1522.
40. Weltzin TE, McCabe E, Flynn D, et al. Anorexia and bulimia nervosa. In: Bardin CW, ed. *Current Therapy in Endocrinology and Metabolism.* 5th ed. St. Louis: Mosby; 1994:15-21.
41. Fichter MM, Quadflieg N. Mortality in eating disorders - results of a large prospective clinical longitudinal study. *Int J Eat Disord.* 2016;49(4):391-401.
42. Duarte C, Ferreira C, Pinto-Gouveia J. At the core of eating disorders: Overvaluation, social rank, self-criticism and shame in anorexia, bulimia and binge eating disorder. *Compr Psychiatry.* 2016;66:123-131.
43. Abbate-Daga G, Marzola E, Amianto F, et al. A comprehensive review of psychodynamic treatments for eating disorders. *Eat Weight Disord.* 2016.
44. Smith C, Fogarty S, Touyz S, et al. Acupuncture and acupressure and massage health outcomes for patients with anorexia nervosa: findings from a pilot randomized controlled trial and patient interviews. *J Altern Complement Med.* 2014;20(2):103-112.
45. Vancampfort D, Vanderlinden J, De Hert M, et al. A systematic review of physical therapy interventions for patients with anorexia and bulimia nervosa. *Disabil Rehabil.* 2014;36(8):628-634.
46. Carei TR, Fyfe-Johnson AL, Breuner CC, et al. Randomized controlled clinical trial of yoga in the treatment of eating disorders. *J Adolesc Health.* 2010;46(4):346-351.
47. Coman A. Emerging technologies in the treatment of anorexia nervosa and ethics: Sufferers' accounts of treatment strategies and authenticity. *Health Care Anal.* 2014.
48. Ashton CH. Insomnia and anxiety. In: Walker R, Edwards C, eds. *Clinical Pharmacy and Therapeutics.* 2nd ed. London: Churchill Livingstone; 1999:393-408.
49. Pratt JP. Affective disorders. In: Walker R, Edwards C, eds. *Clinical Pharmacy and Therapeutics.* 2nd ed. London: Churchill Livingstone; 1999:409-425.
50. Armfield JM. Towards a better understanding of dental anxiety and fear: cognitions vs. experiences. *Eur J Oral Sci.* 2010;118(3):259-264.
51. Fuentes D, Gorenstein C, Hu LW. Dental anxiety and trait anxiety: an investigation of their relationship. *Br Dent J.* 2009;206(8):E17.
52. van Wijk AJ, Hoogstraten J. Anxiety and pain during dental injections. *J Dent.* 2009;37(9):700-704.
53. Binkley CJ, Beacham A, Neace W, et al. Genetic variations associated with red hair color and fear of dental pain, anxiety regarding dental care and avoidance of dental care. *J Am Dent Assoc.* 2009;140(7):896-905.
54. Rosted P, Bundgaard M, Gordon S, et al. Acupuncture in the management of anxiety related to dental treatment: a case series. *Acupunct Med.* 2010;28(1):3-5.
55. Friedlander AH, Gorelick DA. Panic disorder: its association with mitral valve prolapse and appropriate dental management. *Oral Surg Oral Med Oral Pathol.* 1987;63(3):309-312.
56. Little JW. Thyroid disorders: part I, Hyperthyroidism. *Oral Surg Oral Med Oral Pathol Radiol Endod.* 2006;101(3):276-284.
57. Little JW. Eating disorders. *Oral Surg Oral Med Oral Pathol Radiol Endod.* 2002;93(2):138-144.
58. Milosevic A, Brodie DA, Slade PD. Dental erosion, oral hygiene, and nutrition in eating disorders. *Int J Eat Disord.* 1997;21(2):195-199.
59. Foster DW. Anorexia nervosa and bulimia nervosa. In: Fauci AS, Braunwald E, Isselbacher KJ, et al, eds. *Harrison's Principles of Internal Medicine.* 14th ed. New York: McGraw-Hill; 1998:462-472.
60. Devlin MJ. Eating disorders. In: Cutler JL, Marcus ER, eds. *Saunders Text and Review Series: Psychiatry.* Philadelphia: W.B. Saunders Company; 1999:170-185.
61. Feinstein RE. Cognitive and mental disorders due to general medical conditions. In: Cutler JL, Marcus ER, eds. *Saunders Text and Review Series: Psychiatry.* Philadelphia: W.B. Saunders Company; 1999:81-104.
62. Little JW. Dental implications of mood disorders. *J Gen Dent.* 2004;52(5):442-450.
63. Little JW. Alzheimer's disease. *J Gen Dent.* 2005;53(4):289-298.
64. Spreafico RC. Composite resin rehabilitation of eroded dentition in a bulimic patient: a case report. *Eur J Esthet Dent.* 2010;5(1):28-48.

Psychiatric Disorders

DEFINITION

The American Psychiatric Association published the fifth edition of the *Diagnostic and Statistical Manual of Mental Disorders* (DSM) in 2013.¹ It includes detailed descriptions of neurodevelopmental disorders, schizophrenia spectrum and other psychotic disorders, bipolar and related disorders, depressive disorders, anxiety disorders, feeding and eating disorders, sleep-wake disorders, substance-related disorders, addictive disorders, and other topics.

The authors are aware of the implications of applying the new fifth edition of the DSM. We decided to postpone the application. This was based on the need to see how well accepted it becomes. In this edition, the fourth edition of the DSM is used.

Psychiatric problems are important to dentistry because they can affect the clinical course of various medical illnesses, increase required duration of treatment, decrease the patient's functional level, and have a negative impact on overall prognosis and outcome. Of note, disorders related to drug and alcohol use account for a significant proportion of treatment-related psychiatric issues.

COMPLICATIONS: Bleeding, infection, hypotension (related to drugs) and postural hypotension, tardive dyskinesia, malignant neuroleptic syndrome (rare), depression with risk of suicide, and death.

EPIDEMIOLOGY

Mental disorders are common in today's society. Approximately one third of the population in the United States will have at least one psychiatric disorder during their lifetime, and 20% to 30% of adults in the United States will experience one or more psychiatric disorders during a 1-year period. About 5% of the population suffers from serious affective or mood disorders. Schizophrenic disorders are reported in 1.1%.²⁻⁵ In the older adult population, a high prevalence of psychiatric complications is associated with medical illness. About 11% to 15% of these patients experience depressive symptoms, and between 10% and 20% have anxiety disorders, including phobias.

Phobia is the most common psychiatric disorder in women older than 65 years of age. Approximately 20%

of older persons have a substance abuse disorder.⁶ The prevalence of psychiatric disorders among adult dental patients seeking treatment at the Virginia Commonwealth University School of Dentistry was found to be 28% of a randomly selected patient group of 442.⁷ The most common disorder reported was depression.⁶

MOOD DISORDERS

DEFINITION

Mood disorders represent a heterogeneous group of mental disorders that are characterized by extreme exaggeration and disturbance of mood and affect. These disorders are associated with physiologic, cognitive, and psychomotor dysfunction. Mood disorders, which tend to be cyclic, include depression and bipolar disorder.^{4,5,8-10}

EPIDEMIOLOGY

About 5% of the adults in the United States have a significant mood disorder. Mood disorders are more common among women (Table 29.1). Major depression may begin at any age, but the prevalence is highest among older adults followed by those 30 to 40 years of age and, in recent years, an increased number of 15- to 19-year-old adolescents and young adults.¹¹ Lifetime prevalence rates for major depressive disorders are 15% to 20%.⁴ Point prevalence rates for major depression in urban U.S. populations are 2% to 4% for men and 4% to 6% for women.⁵ After the age of 55 years, depression starts to occur more commonly in men.¹¹ About one third of depressed persons require hospitalization; 30% follow a chronic course with residual symptoms and social impairment.^{4,5,11,12}

Etiology

Several theories have been presented to explain the origin of mood disorders. Reduced brain concentrations of norepinephrine and serotonin (neurotransmitters) are believed to cause depression. Increased levels of these neurotransmitters have contributed to the onset of mania. The causes of depression and mania now appear to be complex.^{5,9,12} Current research focuses on the interactions of norepinephrine and serotonin with a variety of other brain systems and on abnormalities in the function or

TABLE 29.1 Epidemiology of Mood Disorders

Variable	Depressive Disorders	Bipolar Disorders
Prevalence	Major depression <ul style="list-style-type: none"> Point prevalence: <ul style="list-style-type: none"> Men: 2.0%–4.0% Women: 4.0%–6.0% Older adults: 11%–15% Lifetime prevalence: <ul style="list-style-type: none"> Overall rate: 15%–20% More common in divorced or separated persons Dysthymia <ul style="list-style-type: none"> Point prevalence: <ul style="list-style-type: none"> Men: 5.0% Women: 8.0% 	Bipolar illness <ul style="list-style-type: none"> Lifetime prevalence: 0.6%–0.9% May be as high as 1%–10% if all subtypes are included Annual incidence: <ul style="list-style-type: none"> Men: 9–15 cases per 100,000 Women: 7.4–32 cases per 100,000 More common in upper socioeconomic groups Equal among races High rates of divorce Cyclothymia <ul style="list-style-type: none"> Lifetime prevalence: 0.4%–3.5%
Age at onset	Late 20s or 30s Childhood possible May have much later onset Higher rate and earlier onset for persons born after 1940 than for those born before	Late teens or early 20s Childhood possible Cyclothymia may precede late onset of overt mania or depression
Family and genetic studies	Unipolar patients tend to have relatives with major depression and dysthymic disorder and fewer with bipolar disorder. Early onset, recurrent course, and psychotic depression appear to be heritable.	Patients with bipolar disorder have many relatives with bipolar disorder, cyclothymia, unipolar depression, and schizoaffective disorder,
Twin studies	Concordance in monozygotic twins: <ul style="list-style-type: none"> Recurrent depression: 59% Single episode only: 33% Concordance rate for identical (monozygotic) twins is four times greater than for fraternal (dizygotic) twins	72% concordance in monozygotic twins; 19% in same sex dizygotic twins

Data from Schiffer RB: Psychiatric disorders in medical practice. In Goldman L, Ausiello D, editors: *Cecil textbook of medicine*, ed 23, Philadelphia, Saunders, 2008.

quantity of receptors for these transmitters. The interactions between thyrotropin and thyroid-stimulating hormone as well as cortisol release by corticotropin-releasing factor and adrenocorticotropin over a long period may be associated with the development of depression. This model suggests that depression is the result of a stress reaction that is prolonged.^{4,5,11,12}

CLINICAL PRESENTATION AND MEDICAL MANAGEMENT

Depressive Disorders

The DSM-IV lists three types of depressive disorders: *major depression*, *dysthymic disorder*, and *depression not otherwise specified* (NOS).¹ Major depression (unipolar) is one of the primary mood disorders. Patients with major depression are depressed most of the day, show a marked decrease in interest or pleasure in most activities, exhibit a marked gain or loss in weight, and have insomnia or hypersomnia (Box 29.1). These symptoms must be present for at least 2 weeks before a diagnosis of major depression can be made. About 50% to 80% of persons who have had a major depressive episode will have at least one

more depressive episode; 20% of these people will have a subsequent manic episode and should be reclassified as bipolar. A major depression usually will last about 8 to 9 months if the patient is not treated (see Box 29.1).

Bipolar Disorder

The DSM-IV lists four types of bipolar disorders: bipolar I, bipolar II, cyclothymic, and bipolar disorder NOS (Fig. 29.1).¹ Fig. 29.2, A, shows the normal variation in moods. Bipolar I disorder consists of recurrences of mania and major depression or mixed states that occur at different times in the patient or a mixture of symptoms that occur at the same time (see Fig. 29.2, B). The essential feature of a manic episode is a distinct period during which the affected person's mood is elevated and expansive or irritable (Table 29.2). Associated symptoms of the manic syndrome include inflated self-esteem, grandiosity, a decreased need for sleep, excessive speech, flight of ideas, distractibility, psychomotor agitation, and excessive involvement in pleasurable activities. During a manic episode, the mood often is described as euphoric, cheerful, or "high." The expansive quality of the mood is characterized by unceasing and unselective enthusiasm for interacting with people. However, the predominant

BOX 29.1 Diagnostic Criteria for Depressive Disorders

Major Depressive Episode

- At least five of the following symptoms have been present during the same 2-week period (one of the symptoms must be depressed mood or loss of interest or pleasure):
- Depressed mood most of the day
 - Marked loss of interest or pleasure in most or all activities most of the day
 - Significant weight gain or loss when not dieting, or change in appetite
 - Insomnia or hypersomnia nearly every day
 - Psychomotor agitation or retardation nearly every day that is observable by others
 - Fatigue or loss of energy nearly every day
 - Feelings of worthlessness or excessive guilt feelings
 - Inability to think or concentrate, or indecisiveness
 - Recurrent thoughts of death, or suicidal ideation without a specific plan, or with a plan, or attempted
 - An organic factor did not initiate or maintain the disturbance.
 - The disturbance is not a normal reaction to the death of a loved one.
 - At no time during the disturbance have there been delusions or hallucinations for as long as 2 weeks in the absence of prominent mood symptoms (i.e., before the mood symptoms developed or after they have remitted).
 - Not superimposed on schizophrenia, schizophreniform disorder, delusional disorder, or psychotic disorder; no other specific diagnosis

Dysthymia

- Depressed mood for most of the day for at least 2 years
- Presence, while depressed, of two or more of the following:
 - Poor appetite
 - Insomnia or hypersomnia
 - Low energy or fatigue
 - Low self-esteem
 - Poor concentration or difficulty making decisions
 - Feelings of hopelessness
- During the 2-year period, the person has never been without the symptoms for more than 2 months at a time.
- No major depressive episode has been present during the first 2 years of the disturbance.
- There has not been an intermixed manic episode.
- The disturbance does not occur during the course of a psychotic disorder.
- The symptoms are not caused by the physiologic effects of a substance.
- The symptoms cause significant distress or functional impairment.

From Schiffer RB: Psychiatric disorders in medical practice. In Goldman L, Ausiello D, editors: *Cecil textbook of medicine*, ed 23, Philadelphia, 2008, Saunders.

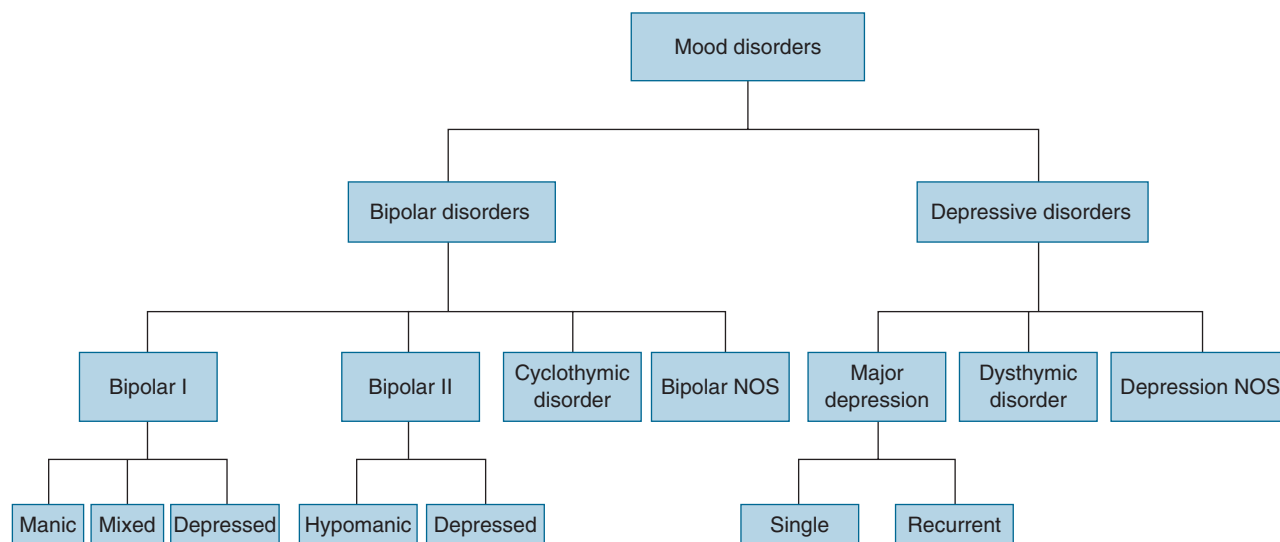

FIG 29.1 Mood disorders listed in the *Diagnostic and Statistical Manual of Mental Disorders*, fourth edition, text revision (DSM-IV-TR). Patients with bipolar disorder have had at least one episode of mania or hypomania. Cyclothymic disorder consists of recurrent brief episodes of hypomania and mild depression. Major depression usually is recurrent but sometimes happens as a single lifetime episode. Dysthymic disorder is mild depression that lasts at least 2 years. NOS, Not otherwise specified.

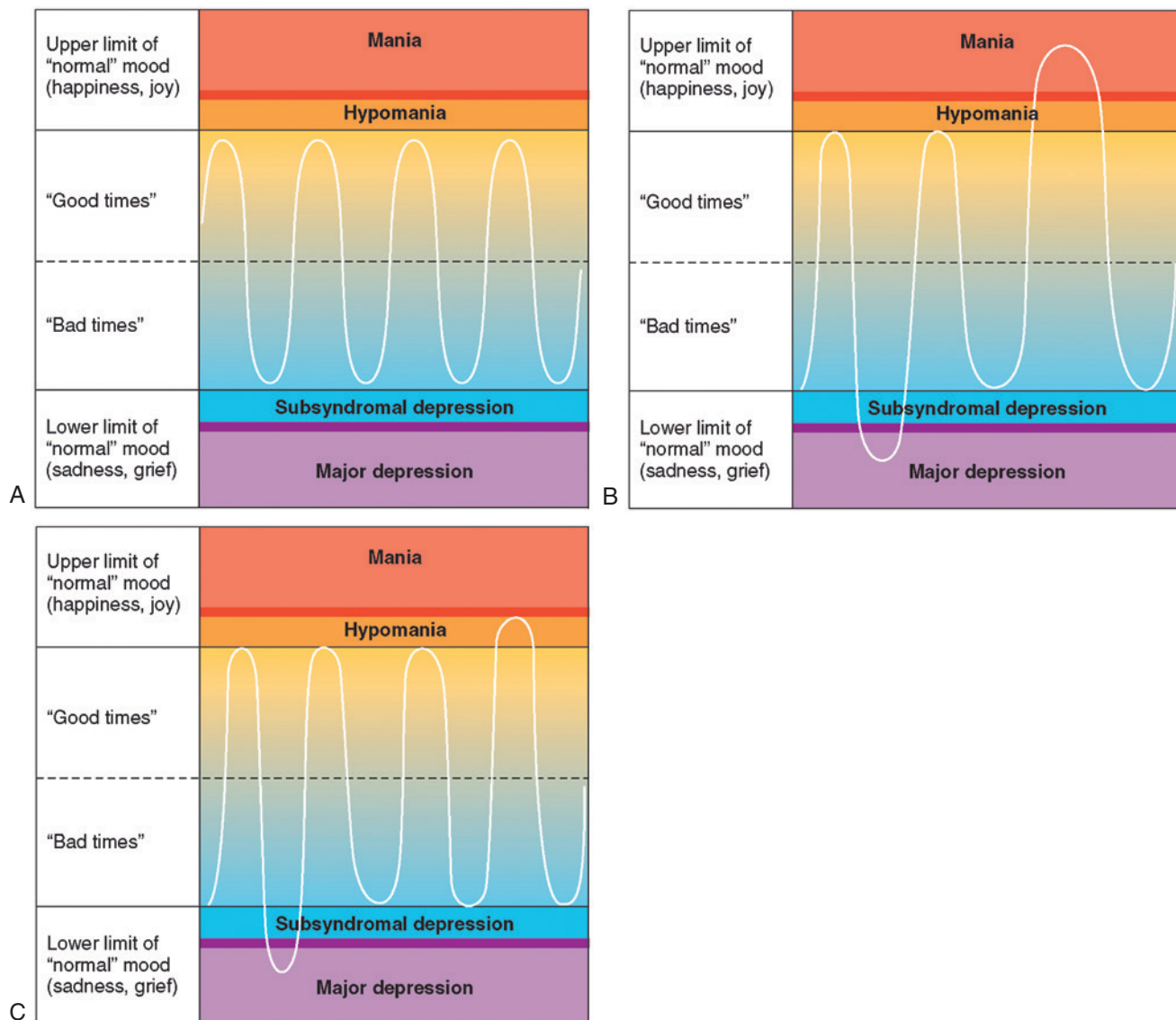

FIG 29.2 **A**, Normal mood cycles. **B**, Bipolar type I disorder. **C**, Bipolar type II disorder. (From Khalife S: Bipolar disorder. In Carey WD, editor: *Current clinical medicine 2009—Cleveland Clinic*, ed 2, Philadelphia, 2010, Saunders.)

mood disturbance may be irritability and anger. Speech often is loud, rapid, and difficult to interpret, and behavior may be intrusive and demanding. Style of dress often is colorful and strange, and long periods without sleep are common. Poor judgment may lead to financial and legal problems. Drug and alcohol abuse also are common in this patient population.^{4,5,13,14}

Bipolar II disorder (see Fig. 29.2, C) consists of recurrences of major depression and hypomania (mild mania). Cyclothymic disorder manifests as recurrent brief episodes of hypomania (see Table 29.2) and mild depression. Bipolar disorder NOS refers to partial syndromes, such as recurrent hypomania without depression. Patients with bipolar disorder have at least one episode of mania or hypomania.^{1,4,9,13,14}

The diagnosis of bipolar disorder is made as soon as the patient has one manic episode, even if the person has never had a depressive episode. Most patients who become manic eventually experience depression. However, about 10% of patients in whom bipolar disorder is diagnosed appear to have only manic episodes.¹⁵

Men tend to have a greater number of manic episodes and more numerous depressive episodes than women. Untreated patients with bipolar disorder will experience a mean of nine affective episodes during their lifetime. The length of each cycle tends to decrease, although the number of cycles increases with age (Fig. 29.3). Each affective episode lasts about 8 to 9 months. Bipolar patients have a greater number of episodes, hospitalizations, divorces, and suicides compared with unipolar patients.¹⁶

TABLE 29.2 Clinical Features of Hypomania and Mania

Feature	Hypomania	Mania
Appearance	May be unremarkable Demeanor may be cheerful	Often striking Clothes may reflect mood state Demeanor may be cheerful Disordered and fatigued in severe states
Behavior	Increased sociability and loss of inhibition	Overactivity and excitement Social loss of inhibition
Speech	May be talkative Mild elation or irritability	Often pressured, with flight of ideas Elated or irritable Boundless optimism Typically, no diurnal pattern May be labile
Vegetative signs	Increased appetite Reduced need for sleep Increased libido	Increased appetite Reduced need for sleep Increased libido
Psychotic symptoms	Not present Thoughts may have an expansive quality	Thoughts may have an expansive quality Delusions and second-person auditory hallucinations may be present, often grandiose in nature Schneiderian first rank (symptoms associated with schizophrenia) symptoms found in 10%–20%
Cognition	Mild distractibility	Marked distractibility More marked disturbances in severe states
Insight	Usually preserved	Insight often lost, especially in severe states

From Mackin P, Young A: Bipolar disorders. In Wright P, Stern J, Phelan M, editors: *Core psychiatry*, ed 2, Edinburgh, 2005, Elsevier.

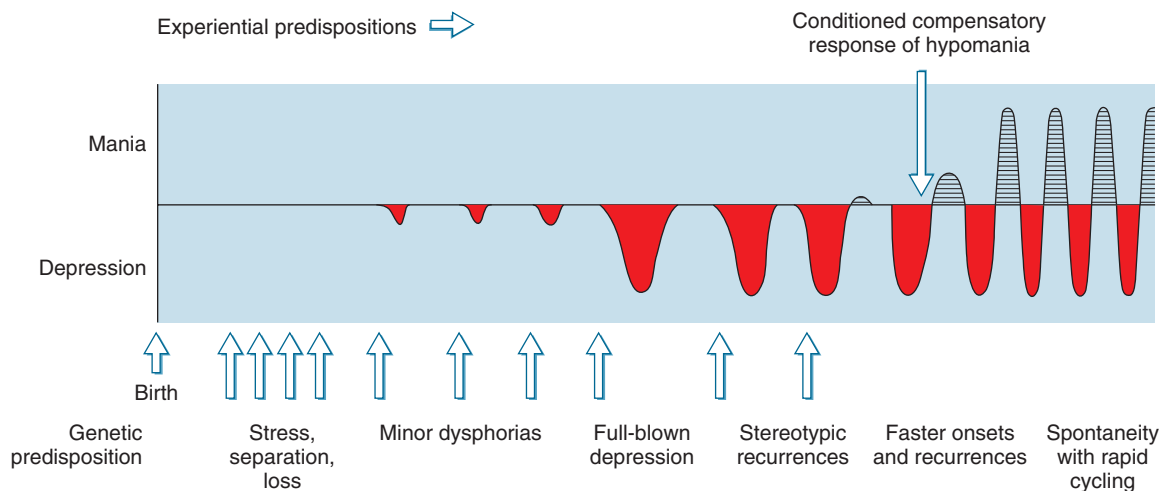

FIG 29.3 Natural history of recurrent mood disorders: an integrated model. Genetic factors and early environmental stress may predispose to development of a mood disorder. Early episodes are likely to be precipitated by environmental stress; later episodes are more likely to occur closer together and spontaneously, without precipitants.

MEDICAL MANAGEMENT

Table 29.3 shows commonly used antidepressants. The first-line medication for major depression is a selective serotonin reuptake inhibitor (SSRI) such as citalopram. Sertraline, venlafaxine, and bupropion are second-line drugs that may be used in patients who fail to achieve remission with citalopram.^{4,5,11-13} These agents are used primarily to treat major depression, dysthymic disorder,

and depression NOS and have a limited role in depression associated with bipolar disorder that responds to an antipsychotic medication and the standard antidepressant medication fluoxetine.^{4,5,9,12,17}

The mainstays of drug therapy for bipolar disorders are the mood-stabilizing drugs, which generally act on both mania and depression (Table 29.4). Drugs used are lithium, valproic acid or divalproex (valproate semisodium), lamotrigine, and carbamazepine.¹⁸ The most widely

TABLE 29.3 Commonly Used Antidepressants (by Structural Group)

Drug	Trade Name	Comments
TRICYCLIC		
Amitriptyline	Elavil	
Trimipramine	Surmontil	
Desipramine	Norpramin	
Doxepin	Sinequan	
Imipramine	Tofranil	
Nortriptyline	Pamelor	
Protriptyline	Vivactil	
TETRACYCLIC		
Maprotiline	Ludiomil	
SELECTIVE SEROTONIN REUPTAKE INHIBITORS		
Escitalopram	Lexapro	
Fluoxetine	Prozac	
Fluvoxamine	Luvox	
Paroxetine	Paxil	
Sertraline	Zoloft	
MONOAMINE OXIDASE INHIBITORS		Patients taking these drugs must be on a tyramine-free diet.
Phenelzine	Nardil	
Tranylcypromine	Parnate	
ATYPICAL OR NONTRICYCLIC		
Nefazodone	Serzone	As effective as imipramine
Venlafaxine	Effexor	SNRI; may be effective in treatment of resistant depression
Amoxapine	Asendin	
Bupropion	Wellbutrin	May be especially helpful for atypical depression
Mirtazapine	Remeron	Increase at 1- to 2-week intervals
Trazodone	Desyrel	Helpful as a second drug for sleep disturbance
Duloxetine	Cymbalta	Additionally useful in pain syndromes

SNRI, Serotonin–norepinephrine reuptake inhibitor.

Data from Schiffer RB: Psychiatric disorders in medical practice. In Goldman L, Ausiello D, editors: *Cecil textbook of medicine*, ed 23, Philadelphia, 2008, Saunders.

used mood stabilizer is lithium carbonate. Lithium is most helpful in patients with euphoric mania. When lithium is ineffective or when medical problems prevent its use, one of the anticonvulsants (valproic acid or divalproex, lamotrigine, or carbamazepine) with mood-stabilizing effects can be used.⁹

Electroconvulsive therapy is an effective antimanic treatment.¹⁹ It may be used in cases of manic violence,

delirium, or exhaustion. It also is appropriate for use with patients who do not respond to medication taken for many weeks. When antidepressant drugs are given for bipolar depression, they may cause a switch to mania or a mixed state, or they may induce rapid cycling. The most common treatment for bipolar depression is an antidepressant combined with a mood stabilizer to prevent a manic switch or rapid cycling.^{4,5,9}

It takes about 7 to 10 days for lithium to reach full therapeutic effectiveness. With most antidepressant drugs, a delay (10–21 days) is noted before full therapeutic benefits are achieved.^{4,5}

An estimated 30,000 suicides occur each year in the United States. About 70% of them involve persons with major depression. The physician must consider suicidal lethality in the management of patients with depression. In general, the risk for suicide is increased in association with the following factors: alcoholism, drug abuse, social isolation, elderly male status, terminal illness, and undiagnosed or untreated mental disorders. Patients at greatest risk are those with a history of previous suicide attempts, drug or alcohol abuse, recent diagnosis of a serious condition, loss of a loved one, or recent retirement and those who live alone or lack adequate social support. Persons with a suicide plan and the means to carry out that plan are at greatest risk for suicide. After medical control is attained in a patient with a mood disorder, insight-oriented psychotherapy often is initiated as an adjunct for management of the patient's condition.^{5,13,19,20}

An interesting potential is the role of celebrity suicides triggering others on an international basis.²¹ For example, after the railway suicide of the German national goalkeeper Robert Enke in 2009, a significant increase of railway suicides was observed nationally. Enke's suicide in 2009 was also followed by increasing train suicide numbers in Europe. An international copycat effect or an increased overall awareness about this particular suicide method appears to be one likely explanation for the changes.²¹

SOMATOFORM DISORDERS

DEFINITION

Persons with somatoform disorders have physical complaints for which no general medical cause is present. Associated unconscious psychological factors contribute to the onset, exacerbation, or maintenance of physical symptoms. The following conditions are regarded as somatoform disorders: somatization, conversion disorder, pain disorder, and hypochondriasis (Table 29.5). Patients with a somatization disorder experience multiple, unexplained somatic symptoms that may last for years.^{4,5,13}

EPIDEMIOLOGY

The prevalence of somatoform disorders is 5%.⁴ Most of these occur in women. Patients with symptoms that

TABLE 29.4 Initial Treatment Guidelines for Bipolar Disorder

Drug or Indication Category	Step 1		Step 2		Step 3
	Starting Dose	Target	Drug	Starting Dose	Additional Options
DEPRESSION					
Lithium	300–450 mg twice daily	Serum level >0.8 mEq/L	OFC*	6 mg/25 mg at bedtime	Combinations of lithium, OFC, quetiapine
Lamotrigine	25 mg once a day Initial and target doses may be affected by concomitant medications	Dose 50–200 mg/day	Quetiapine (pending FDA approval for bipolar disorder type 1 and type 2 depression)	100 mg at bedtime; increase to 300 mg at bedtime by day 3	Add traditional antidepressant [†] to one or more of these (step 1 or step 2) ECT
MANIA					
Lithium	300–450 mg three times a day	Serum level generally 1.0–1.5 mEq/L	Choose two of the following in combination: Lithium VPA or divalproex AAP (excluding olanzapine and clozapine)		Other two-drug combinations (choose from lithium, VPA, AAPs, carbamazepine, oxcarbamazepine, topiramate)
VPA	500 mg three times a day				
Divalproex	750 mg at bedtime				
AAP (excluding clozapine and aripiprazole)	Initial dosing varies				ECT Clozapine Triple-drug therapy

*Approved by the U.S. Food and Drug Administration (FDA) - for bipolar disorder type 1 depression.

[†]Traditional antidepressants include selective serotonin reuptake inhibitors, serotonin–norepinephrine uptake inhibitors, bupropion, venlafaxine, and mirtazapine.

AAP, Atypical antipsychotic [agent]; ECT, electroconvulsive therapy; OFC, olanzapine–fluoxetine combination; VPA, valproic acid.

From Khalife S, Singh V, Muzina DJ: Bipolar disorder. In Carey WD, editor: *Current clinical medicine 2009—Cleveland Clinic*, Philadelphia, 2009, Saunders.

do not meet the full criteria for somatization disorder are much more common. Conversion disorder, pain disorder, and hypochondriasis appear to be more common than somatization disorder.⁴

Etiology

In this group of disorders, physical symptoms suggest a physical disorder for which no underlying physical basis can be found. Symptoms are linked to psychological factors. Somatization therefore is defined as the manifestation of psychological stress in somatic symptoms.

A conversion reaction results when a psychological conflict or need is expressed as an alteration or loss of physical function, suggesting a physical disorder. A person who views a traumatic event, for example, but has a conflict about acknowledging that event may develop a conversion disorder of blindness. In this instance, the symptom of blindness has symbolic value and is a representation of, and a partial solution to, the underlying psychological conflict.^{4,5,13}

CLINICAL PRESENTATION AND MEDICAL MANAGEMENT

Somatization Disorder

Somatization consists of multiple signs and symptoms and usually begins before the age of 30 years. Patients experience multiple, unexplained physical manifestations of illness or disease, which may include pain, diarrhea, bloating, vomiting, sexual dysfunction, blindness, deafness, weakness, paralysis, or coordination problems. Somatization disorder is a serious psychiatric illness. Many patients have concurrent anxiety, depression, or personality disorder.^{4,5,13}

Conversion Disorder

Conversion disorder is a monosymptomatic somatoform disorder that affects the voluntary motor system or sensory functions. The patient may experience blindness, deafness, paralysis, or an inability to speak or to walk. Symptoms suggest a physical condition, but the cause is psychological.

TABLE 29.5 Somatoform Disorders

Somatoform Disorder	Features
Somatization disorder	Chronic multisystem disorder characterized by complaints of pain, and GI and sexual dysfunction. Onset usually is early in life, and psychosocial and vocational achievements are limited. Rarely affects men. Diagnostic criteria include four pain symptoms plus two GI symptoms plus one sexual or reproductive symptom plus one pseudoneurologic symptom.
Conversion disorder	Syndrome of symptoms or deficits mimicking neurologic or medical illness in which psychological factors are judged to be of etiologic importance. Patients report isolated symptoms that have no physical cause (blindness, deafness, stocking anesthesia) and that do not conform to known anatomic pathways or physiologic mechanisms. In a group of such patients followed over time, a physical disease process will become apparent in 10% to 50%.
Pain disorder	Clinical syndrome characterized predominantly by pain in which psychological factors are judged to be of etiologic importance
Hypochondriasis	Chronic preoccupation with the idea of having serious disease. This preoccupation usually is poorly amenable to reassurance. May consist of a morbid preoccupation with physical symptoms or bodily functions. Can be described as "illness is a way of life."
Body dysmorphic disorder	Preoccupation with an imagined or exaggerated defect in physical appearance
OTHER SOMATOFORM-LIKE DISORDERS	
Factitious disorder	Intentional production or feigning of physical or psychological signs when external reinforcers (e.g., avoidance of responsibility, financial gain) are not clearly present Voluntary production of symptoms without external incentive More common in men and seen in health care workers more often Skin lesions more common than oral (oral lesions cannot be seen) Oral lesions include those associated with self-extraction of teeth, picking at the gingiva with fingernails, nail file gingival injury, and application of caustic substances to the lips.
Malingering	Intentional production or feigning of physical or psychological signs when external reinforcers (e.g., avoidance of responsibility, financial gain) are present
Dissociative disorders	Disruptions of consciousness, memory, identity, or perception judged to be due to psychological factors

GI, Gastrointestinal.

From Schiffer RB: Psychiatric disorders in medical practice. In Goldman L, Ausiello D, editors: *Cecil textbook of medicine*, ed 23, Philadelphia, 2008, Saunders, and Scully C, Cawson RA: *Medical problems in dentistry*, ed 5, Edinburgh, 2005, Churchill Livingstone.

The somatic manifestation, which is not intentionally produced, typically is a symbolic representation that relieves an underlying emotional conflict.^{4,5,13}

Pain Disorder

Pain disorder causes the patient significant distress in important areas of functioning such as social and occupational activities. In patients with pain disorder, no organic disease can be identified. Often, a stressful event precedes the onset of pain. Pain often results in secondary gain in the form of increased attention and sympathy from others.^{4,5,13}

Hypochondriasis

Patients with hypochondriasis are preoccupied with the fear or belief that they have a serious disease. Their misinterpretations of normal bodily functions generally are to blame.^{4,5,13}

Factitious Disorder

Factitious disorder consists of intentional self-harm that is produced by infliction of physical, chemical, or thermal injury. It involves the voluntary production of signs and

symptoms (physical injury or psychological symptoms) without external incentives such as avoidance of responsibility or financial gain. Many affected persons also have other mental disorders. Factitious disorder is more common among men and occurs more often in health care workers. The skin is the most common site for injury.

Treatment

Treatment of patients with somatoform disorders often requires multiple therapeutic modalities, including psychotherapy for their interpersonal and psychological problems. Medication for the treatment of underlying depressive disorder also may be needed. Group therapy is beneficial in some cases.^{4,5,13}

SCHIZOPHRENIA

Schizophrenia is characterized by disordered thinking, inappropriate emotional responses, hallucinations, delusions, and bizarre behavior. The lifetime prevalence rate for schizophrenic disorders is about 1% to 1.5% (across all cultures and both genders). Worldwide, the prevalence is 0.85%.⁴ Onset usually is during adolescence or early

adulthood. Studies have suggested an earlier onset in men than in women.^{4,22}

EPIDEMIOLOGY

The cause of schizophrenia is not known, but it appears to involve the interaction of genetic and environmental factors.¹⁰ Evidence for a genetic relationship has come from family, twin, and adoption studies. Family studies have shown a 13% risk for schizophrenia in children with one affected parent. If both parents have schizophrenia, the risk increases to 46%.²³ The risk of developing schizophrenia for first-degree relatives is 5% to 10%, and for second-degree relatives, it is 2% to 4%. Concordance in twins for schizophrenia is 46% for identical twins and 14% for nonidentical twins. However, 89% of persons with schizophrenia do not have a parent with the disease, and 81% do not have a parent or a sibling with the disease.^{4,5,13} Despite evidence for a genetic causation, the results of molecular genetic linkage studies in schizophrenia are inconclusive.^{4,22}

The predominant biologic hypothesis for a neurophysiologic defect in schizophrenia is the dopamine hypothesis, which states that symptoms of schizophrenia are caused in part by a disturbance in dopamine-mediated neuronal pathways in the brain.²³ Involvement of the dopaminergic neural systems innervating the frontal and mesiotemporal cortex appears important.

Schizophrenia appears to be triggered by certain environmental events in a genetically predisposed person.²⁴ Drugs, medical illness, stressful psychosocial events, viral infection, and family situations characterized by conflicting and self-contradictory forms of communication have been reported to precipitate schizophrenia in susceptible people.²³

CLINICAL PRESENTATION AND MEDICAL MANAGEMENT

According to the DSM-IV definition, schizophrenia can be diagnosed in patients who have two or more of the following symptoms for at least 1 month: hallucinations, delusions, disorganized speech, grossly disorganized or catatonic behavior, or negative symptoms such as affective flattening, alogia (poverty of speech, lack of additional unprompted content), or avolition (lack of desire, drive, or motivation). In addition, the patient's social or occupational functioning must have deteriorated.^{13,22}

Patients with schizophrenia show psychotic symptoms consisting of delusions, hallucinations, incoherence, catatonic behavior, or flat or grossly inappropriate affect. Delusions and hallucinations are referred to as "positive" symptoms, and withdrawal and reduction of affective expression are referred to as "negative" symptoms. Delusions, such as thought broadcasting or being controlled by a deceased person, usually are bizarre. Hallucinations are prominent and occur throughout the day for several

days or several times a week for several weeks (Table 29.6). The four types of schizophrenic disorders are *catatonic*, *disorganized*, *paranoid*, and *undifferentiated*. Patients with schizophrenic disorders show deterioration in their level of functioning at work and in social relations and self-care. They often are confused, depressed, withdrawn, anxious, and without emotion. Physically, they may grimace and pace about, or they may be rigid and catatonic. Life stresses appear to trigger the disorder, often during late adolescence and early adulthood.^{13,22,23}

In schizophrenia, two types of thought disturbances are seen: formal thought disorder and disorder of thought content. *Formal thought disorders* affect relationships and associations among the words used to express thought. Thoughts may be strung together by incidental associations, or they may be completely unrelated. Thought blocking is common with psychotic patients. *Disorders of thought content* involve the development of delusions, which are fixed ideas that are based on incorrect perceptions of reality. Delusions, which commonly are paranoid or persecutory, also may be bizarre, somatic, grandiose, or referential (as to events that the patient believes have special significance). Perceptual disturbances in patients with schizophrenia include auditory, visual, tactile, olfactory, and gustatory hallucinations.^{13,23}

The most common emotional change in schizophrenia is a general "blunting" or "flattening" of affect. The patient seems to be emotionally detached or distant, may appear wooden and robot-like, and may lack warmth or spontaneity. Paranoid patients may feel frightened or enraged in response to a perceived threat or a delusion of persecution. They can be very hostile and guarded to any perceived slight.^{13,23}

The long-term course of illness is variable. About 25% of patients experience full remission of symptoms. Another 25% have mild residual symptoms. The remaining 50% continue to have moderate to severe symptoms.^{22,25}

DRUGS USED TO TREAT PSYCHIATRIC DISORDERS

Drug treatment has the most dramatic impact on control of symptoms and improvement in quality of life of patients with schizophrenia. Psychotherapy and other psychosocial treatments also are important because they provide patients with the human connection that helps them develop social skills, educates them about their illness and what to expect, and offers support throughout a long, difficult course of illness. Drug treatment of schizophrenic disorders consists of antipsychotic medications that act selectively against specific target symptoms. These drugs are effective for "positive" symptoms such as hallucinations and psychotic agitation but are noneffective for "negative" symptoms such as social withdrawal or anhedonia (inability to get pleasure from or find interest in activities). The newer atypical antipsychotic medications (clozapine, olanzapine, risperidone, and quetiapine) are quite effective for control

TABLE 29.6 Schizophrenia and Other Psychotic Disorders

Diagnostic Features of Schizophrenia			Schizoaffective and Mood Disorder Exclusion	Substance or General Medical Condition Exclusion
Characteristic Symptoms	Social or Occupational Dysfunction	Duration		
At least two of the following, each present for a major portion of the time during a 1-month period (or less if successfully treated)*	For a significant portion of the time since the onset of the disturbance, one or more major areas of functioning (e.g., work, interpersonal relationships, self-care) are markedly below the level achieved before onset (or, when onset is in childhood or adolescence, failure to realize the expected level of interpersonal, academic, or occupational achievement).	Continuous signs of the disturbance persist for at least 6 months. This 6-month period must include at least 1 month of characteristic symptoms as described (i.e., active-phase symptoms) and may include periods of prodromal or residual symptoms. During these prodromal or residual periods, signs of the disturbance may be manifested by only negative symptoms or two or more of the characteristic symptoms present in an attenuated form (e.g., odd beliefs, unusual perceptual experiences).	Schizoaffective disorder and mood disorder with psychotic features have been ruled out because (1) no major depressive or manic episodes have occurred concurrently with the active-phase symptoms or (2) if mood episodes have occurred during active-phase symptoms, their total duration has been brief in relation to the duration of the active and residual periods.	The disturbance is not due to the direct effects of a substance (e.g., drugs of abuse, medication) or a general medical condition.
Delusions				
Hallucinations				
Disorganized speech (e.g., frequent derailment, “jumping from one topic to another,” or incoherence)				
Grossly disorganized or catatonic behavior				
Negative symptoms (i.e., affective flattening, alogia, or avolition)				

*Only one characteristic symptom is required if delusions are bizarre or hallucinations consist of a voice keeping a running commentary on the person's behavior or thoughts or involve two or more voices conversing with each other.

From Schiffer RB: Psychiatric disorders in medical practice. In Goldman L, Ausiello D, editors: *Cecil textbook of medicine*, ed 23, Philadelphia, 2008, Saunders.

of both “positive” and “negative” symptoms of schizophrenia and are associated with minimal movement adverse effects. Antipsychotic drugs are described later in this chapter.^{13,25}

Antidepressant Medications (Excluding Those for Bipolar Depression)

Tricyclic Antidepressants. The group of drugs used primarily to treat depression are the tricyclic antidepressants (TCAs) (see Table 29.3). The first tricyclic used to treat depression was imipramine. Tricyclics inhibit neural reuptake of norepinephrine and 5-hydroxytryptamine (5-HT), resulting in downregulation of their respective receptors. All tricyclics are equally effective in the management of depression, but these agents differ in their associated adverse effects.¹⁸ Amitriptyline and doxepin are the most sedating, and this adverse effect is put to advantage by patients who take these drugs just before bedtime. Two combinations of drugs are available for treating depression and other psychotic symptoms. Triavil (amitriptyline plus perphenazine) is used to treat patients with depression and agitation or psychotic behavior. Limbitrol (amitriptyline plus chlordiazepoxide) is used to treat patients with depression and anxiety.³⁻⁵ Table 29.3 summarizes the drugs used to treat depression.

Adverse effects associated with tricyclics include dry mouth, constipation, blurred vision, cardiac dysrhythmias such as tachycardia, hypotension, blurred vision, allergic reactions, and important drug interactions (Table 29.7). Tricyclic drugs should be used with caution in patients with cardiac conditions because of the associated risk for atrial fibrillation, atrial ventricular block, or ventricular tachycardia. Tricyclics can lower the seizure threshold and must be used with care in patients with a history of seizures. They can increase intraocular pressure in patients with glaucoma. Urinary retention may be increased in patients with prostate hypertrophy. Erectile or ejaculatory disturbances occur in up to 30% to 40% of patients. If used in some patients with bipolar disorder, tricyclics can reduce the time between episodes, induce manic episodes, and cause rapid cycling of the clinical course of the disorder.³⁻⁵

Drug interactions reported with the use of TCAs include: (1) may potentiate the effects of other central nervous system (CNS) depressants such as ethanol and benzodiazepines; (2) may potentiate the actions of anticholinergic drugs such as antihistamines; (3) may result in reduced levels with use of oral contraceptives, alcohol, barbiturates, and phenytoin sodium (Dilantin); and (4) may cause potentiation of the pressor effects of sympathomimetic agents such as epinephrine and levonordefrin,

TABLE 29.7 Adverse Effects and Drug Interactions of Antidepressant Drugs

Category of Complications	Tetracyclics	MAO Inhibitors	SSRIs	SNRIs
Adverse effects	Dry mouth Nausea and vomiting Constipation Urinary retention Postural hypotension Nervousness Insomnia Drowsiness Sleepiness Reflux Anorgasmia (women) Erectile problems (men) Loss of libido Gynecomastia (men)	Dry mouth Nausea and vomiting Constipation Urinary retention Drowsiness Confusion Anorexia Weight gain Tremor Fatigue Insomnia Anorgasmia (women) Erectile problems (men)	Dry mouth Nausea and vomiting Diarrhea Anorexia Weight loss Blurred vision Insomnia Nervousness Sexual dysfunction Sweating Sedation (paroxetine) Akathisia	Dry mouth Nausea and vomiting Constipation Somnolence Weight loss/gain Blurred vision Dizziness Anorexia Impotence Loss of libido
Serious adverse effects	Mania Seizures Obstructive jaundice Leukopenia Tachycardia Arrhythmias Myocardial infarction Stroke	Mania Hypertensive crisis Orthostatic hypotension Peripheral edema Anemia Leukopenia Thrombocytopenia Agranulocytosis	Mania Seizures Orthostatic hypotension Anemia Bleeding (platelet effect) Hypothyroidism	Mania Hypertension (venlafaxine)
DRUG INTERACTIONS				
Barbiturates	CNS depression	CNS depression		
Benzodiazepines	CNS depression	CNS depression	CNS depression	
SSRIs	Dangerous—do not use	Dangerous—do not use		Serotonin syndrome Seizures
SNRIs	Dangerous—do not use	Dangerous—do not use	Dangerous—do not use	
MAO inhibitors	Anticholinergic toxicity	Do not use two or more agents		Dangerous—do not use
Heterocyclics	Dangerous—do not use	Dangerous—do not use		Dangerous—do not use
Anticonvulsants	Interferes with action of anticonvulsants	Interferes with action of anticonvulsants		
Antihistamines	CNS depression	CNS depression		
Beta-blockers	Anticholinergic toxicity	Sinus bradycardia	Bradycardia	
Warfarin	Warfarin metabolism inhibited—can lead to increased INR values		Warfarin metabolism inhibited—can lead to increase in INR values	
Cimetidine	Inhibits clearance—can lead to toxicity		Inhibits clearance—can lead to overdose	
Erythromycin	Interferes with action of the antibiotic			
Opioid analgesics	Increase sedative effect			
Vasoconstrictors	Actions are enhanced	Actions are enhanced		
• Epinephrine	Use with caution	Use with caution		
Levonordefrin		Best to avoid		
Phenylephrine		Avoid		
Interactions involving foods and beverages				
Tyramine	Avoid	Hypertension or arrhythmias; must avoid these agents		
Caffeine	Avoid			
Ethanol	CNS depression	CNS depression		

CNS, Central nervous system; INR, international normalized ratio; MAO, monoamine oxidase; SNRI, serotonin–norepinephrine reuptake inhibitor; SSRIs, selective serotonin reuptake inhibitor.

blockade of the antihypertensive effects of guanethidine, and induction of a hypertensive crisis if taken with or soon after an MAO inhibitor (see Table 29.7). Overdosage with a TCA can cause death from cardiac arrhythmia or respiratory failure.³⁻⁵

Monoamine Oxidase Inhibitors. Traditional monoamine oxidase (MAO) inhibitors, which are both nonselective and irreversible, were the first effective drugs used for the treatment of depression. Only two drugs now on the market are included in the group of MAO inhibitors: phenelzine (Nardil) and tranylcypromine (Parnate). These drugs prevent the breakdown of monoamine neurotransmitters. If a patient is changing from an MAO inhibitor drug to a tricyclic drug, 2 weeks or more must elapse after the MAO inhibitor is stopped before the tricyclic agent is begun. Significant drug interactions may occur between MAO inhibitors and opioids and sympathomimetic amines. MAO inhibitors potentiate the depressant activity of opioids. They can produce a hypertensive crisis if combined with specific sympathomimetic amines (see Table 29.7).^{5,12,26}

Phenylethylamine and phenylephrine must not be given to patients who are taking MAO inhibitors. MAO metabolizes these agents, and their use with an MAO inhibitor could lead to significant potentiation of their pressor effects (see Chapter 4). These adverse effects are not seen with epinephrine and levonordefrin. Many over-the-counter cold remedies contain phenylephrine and should not be prescribed for patients who are taking MAO inhibitors (see Table 29.7).

Tyramine is a naturally occurring amine that releases norepinephrine from sympathetic nerve endings. Dietary tyramine is deaminated by gastrointestinal MAO-A. In the presence of MAO inhibitors, dietary tyramine is rapidly absorbed into the circulation, and a hypertensive crisis may result. Patients taking these agents must therefore avoid foods that contain high concentrations of tyramine. Such foods include aged foods such as cheeses, red wines, and pickled fish, as well as bananas and chocolate.^{5,12,26}

Second-Generation Antidepressant Drugs

Selective Serotonin Reuptake Inhibitors. The selective serotonin reuptake inhibitors (SSRIs) include fluoxetine (Prozac), sertraline (Zoloft), paroxetine (Paxil), escitalopram (Lexapro), and fluvoxamine (Luvox); these agents now are considered first-line drugs for the treatment of depression. As a group, these drugs are just as effective as the tricyclics, but they are not more effective (see Table 29.7). Many physicians consider SSRIs to be first-line drugs for the treatment of depression.^{3-5,12}

Atypical or Nontricyclic Antidepressant Agents. Amoxapine (Asendin), bupropion (Wellbutrin), trazodone (Desyrel), maprotiline (Ludiomil), nefazodone (Serzone), mirtazapine (Remeron), venlafaxine (Effexor), and duloxetine (Cymbalta) are other nontricyclics that are used as antidepressants.¹⁸ Bupropion has a greater tendency to produce seizures than the other antidepressants.

Nefazodone does not cause sexual adverse effects. Mirtazapine was one of the first antidepressants to demonstrate a significantly improved toxicity profile after overdose (see Tables 29.3 and 29.7).

Bipolar Depression Drugs. There are many more Food and Drug Administration (FDA)-approved options for the treatment of mania than for treatment of bipolar depression.⁸ The combination agent olanzapine (an atypical antipsychotic) plus fluoxetine (OFC) is the only FDA-approved drug for treatment of acute bipolar depression.⁹ Antidepressants, when prescribed alone, are not effective in bipolar depression. Olanzapine has been associated with weight gain and hyperglycemia. Dosing of OFC as Symbyax starts with the 6/25 formulation (olanzapine 6 mg and fluoxetine 25 mg) daily and is adjusted as needed to the 12/50 formulation (see Table 29.4).⁹ Other atypical antipsychotics may serve as potential antidepressant agents for management of bipolar depression.⁹

Mood-Stabilizing Drugs

Lithium. Lithium has some antidepressant effects, but it is primarily used for the treatment of patients with bipolar disorder. Its mode of action is unclear, but it decreases norepinephrine release and increases serotonin synthesis. Lithium is used to treat acute manic episodes and to prevent manic episodes in patients with bipolar disorder. It is effective when used alone in 60% to 80% of patients with classic bipolar disorder (see Table 29.4). Lithium should not be used if renal disease is present. Lower doses must be used in older patients. The dose ranges from 600 to 3000 mg/day, and full therapeutic effect is attained in 7 to 10 days. Patients who are on maintenance therapy should be evaluated every 3 to 6 months for serum levels of lithium, sodium, potassium, creatinine, thyroxine (T₄), thyroid-stimulating hormone, and free T₄ index. Medical complications associated with long-term lithium use include nontoxic goiter and hypothyroidism, arrhythmia, T-wave depression, and vasopressin-resistant nephrogenic diabetes insipidus. All of these complications are related to the effects of lithium on adenylate cyclase activity. Drugs that interact with lithium include erythromycin and nonsteroidal antiinflammatory drugs (NSAIDs), which increase serum lithium levels, possibly leading to toxicity.^{4,5,9,14}

Carbamazepine. Carbamazepine, an anticonvulsant drug that stabilizes voltage-gated sodium channels, has been successfully used in the treatment of manic episodes in patients with bipolar disorder who do not respond to lithium or who cannot take lithium because of associated complications. The dose is 600 to 1600 mg/day. Adverse effects include nausea, blurred vision, ataxia, leukopenia, and aplastic anemia.^{4,5,9,14}

Valproic Acid and Divalproex. Valproic acid is used as an anticonvulsant and mood-stabilizing drug, primarily in the treatment of epilepsy and bipolar disorder. It acts on γ -aminobutyric acid levels and is marketed under the brand names Depakote, Depakote ER, Depakene, Depacon, and Stavzor. It is used when lithium cannot be tolerated

by the patient. Valproic acid should not be used with the benzodiazepine clonazepam and aspirin to avoid adverse effects.⁹ Divalproex sodium consists of valproate semi-sodium, a compound of sodium valproate, and valproic acid in a 1:1 molar relationship in an enteric-coated tablet form.

Lamotrigine. Lamotrigine is an anticonvulsant drug used to treat epilepsy and bipolar disorder. It is a sodium channel blocking drug marketed as Lamictal. It is an effective mood stabilizer and is the only drug approved for this purpose since the FDA approved lithium about 30 years ago.⁹ Lamotrigine is approved by the FDA for the maintenance treatment of bipolar disorder type 1. The starting dosage of lamotrigine ranges from 25 mg to 300 mg/day.⁸ Common side effects include headaches; body aches and cramps; hysteria; muscle aches; abdominal pain; back pain; dizziness and lack of coordination; acne, rash, and skin irritation; sleepiness, insomnia, vivid dreams or nightmares, and night sweats; dry mouth, mouth ulcers, and damage to tooth enamel; fatigue and memory and cognitive problems; blurred or double vision; irritability, weight changes; hair loss; changes in libido; frequent urination; nausea; fever; tremor; appetite changes; and other side effects. In rare cases, lamotrigine has been known to cause the dangerous drug eruptions, Stevens-Johnson syndrome, and toxic epidermal necrolysis. Drug interactions include those with hormonal forms of birth control, carbamazepine, divalproex, oxcarbazepine, phenobarbital, phenytoin, rifampin, and valproic acid.

Antipsychotic (Neuroleptic) Drugs. The introduction of chlorpromazine in the 1950s revolutionized the practice of psychiatry. Other agents have been introduced since

chlorpromazine, but none represents any real improvement beyond this prototypical agent.¹⁸ The popularity of these drugs is highlighted by the fact that two thirds of all prescriptions for antidepressant and antipsychotic (neuroleptic) drugs are written by physicians other than psychiatrists. Antipsychotic drugs appear to work by antagonizing the effects of dopamine in the basal ganglia and limbic portions of the forebrain. Because of significant adverse reactions associated with their use, these agents should be used only when they are clearly the drugs of choice.^{5,26,27}

Antipsychotic drugs are categorized as first-generation (typical) or second-generation (atypical). The following are examples of typical antipsychotic drugs: chlorpromazine (Thorazine), thioridazine (Mellaril), fluphenazine (Prolixin), and haloperidol (Haldol). Clozapine (Clozaril), risperidone (Risperdal), olanzapine (Zyprexa), and quetiapine (Seroquel) are examples of atypical antipsychotic drugs.¹⁸ In general, the typical antipsychotic drugs are more likely to cause extrapyramidal symptoms of all types. Although the atypical drugs are much less likely to cause such symptoms, their use is not without risk for these and other adverse effects.²⁸

Antipsychotic drugs sedate, tranquilize, blunt emotional expression, attenuate aggressive and impulsive behavior, and cause disinterest in the environment. They leave higher intellectual functions intact but ameliorate the bizarre behavior and thinking of psychotic patients. All of these drugs have significant anticholinergic adverse effects and produce dystonias and extrapyramidal symptoms. Commonly used antipsychotic drugs are shown in Table 29.8.^{5,26,27}

TABLE 29.8 Commonly Used Antipsychotic Medications

Class	Drug	Trade Name	Adverse Effect(s)
Phenothiazine–aliphatic	Chlorpromazine	Thorazine	EPMD
	Perphenazine	Trilafon	EPMD
Phenothiazine–piperazine	Fluphenazine	Prolixin	EPMD
	Trifluoperazine	Stelazine	EPMD
	Thioridazine	Mellaril	EPMD, risk for retinal degeneration
Phenothiazine–piperidine	Mesoridazine	Serentil	EPMD, risk for retinal degeneration
	Haloperidol	Haldol	EPMD, dysphoria
Butyrophenone			EPMD, dysphoria
Thioxanthene	Chlorprothixene	Taractan	
	Thiothixene	Navane	
Dibenzoxazepine	Loxapine	Loxitane	
Dihydroindole	Molindone	Moban	Less likely to reduce seizure threshold
Benzisoxazole	Risperidone	Risperdal	Low incidence of EPMD effects
Dibenzodiazepine	Olanzapine	Zyprexa	Fewer EPMD effects, agranulocytosis
	Clozapine	Clozaril	Fewer EPMD effects, agranulocytosis
Diphenylbutylpiperidine	Pimozide	Orap	
Phenylindole	Quetiapine	Seroquel	Low incidence of EPMD effects
	Ziprasidone	Geodon	Low incidence of EPMD effects
Piperazinyl–dihydrocarbostyryl	Aripiprazole	Abilify	Hyperglycemia

EPMD, Extrapyramidal movement disorder.

Data from Schiffer RB: Psychiatric disorders in medical practice. In Goldman L, Ausiello D, editors: *Cecil textbook of medicine*, ed 23, Philadelphia, 2008, Saunders.

Adverse effects of the antipsychotic drugs are numerous and often significant (Table 29.9). The anticholinergic actions produced by these drugs include dry mouth, postural hypotension, constipation, and urinary retention. Other adverse effects observed are obstructive jaundice, retinal pigmentation, lenticular opacity, skin pigmentation, and male impotence.^{4,5,14}

TABLE 29.9 Adverse Reactions of Antipsychotic Drugs Based on Type of Neuroreceptor Affected

Neuroreceptor	Adverse Effects
Anticholinergic	Dry mouth Urinary hesitancy Constipation Urinary retention Dry eyes Sexual dysfunction Blurred vision Mild tachycardia Closed-angle glaucoma Impaired memory and confusion
Antiserotonergic	Weight gain (antihistaminergic mechanisms also proposed)
Antiadrenergic	Dizziness Postural hypotension (may lead to falls and hip fractures in older patients) Sexual dysfunction
Antidopaminergic	Hyperprolactinemia (causes hypogonadism) <ul style="list-style-type: none"> In men: gynecomastia, impotence, loss of libido, impaired spermatogenesis In women: amenorrhea, altered ovarian function, loss of libido, risk for osteoporosis Extrapyrarnidal syndromes (least frequent with atypical drugs—olanzapine, quetiapine, risperidone, and ziprasidone) Acute dystonia: <ul style="list-style-type: none"> Parkinsonism Akathisia Tardive dyskinesia
Combination of receptors	Neuroleptic malignant syndrome—rigidity, fluctuating consciousness (delirium, stupor), and autonomic lability (hyperthermia, tachycardia, hypotension or hypertension, sweating, pallor, salivation, and urinary incontinence)
Other adverse effects	Agranulocytosis Cholestatic jaundice Seizures With some agents, increased risk of suicide or suicidal behavior (during induction of drug)

From Wright P, Perahia D: Psychopharmacology. In Wright P, Stern J, Phelan M, editors: *Core psychiatry*, ed 2, Edinburgh, 2005, Elsevier.

The extrapyramidal adverse effects (motor or movement disorders) include acute and chronic conditions. During the first 5 days of treatment with an antipsychotic agent, acute muscular dystonic reactions, or a Parkinson-like syndrome may occur. Akathisia, or extreme motor restlessness, also may develop early in treatment. Clinical manifestations consist of involuntary repetitive movements of the lips (lip smacking), the tongue (tongue thrusting), the extremities, and the trunk. The risk for dystonia increases for patients older than 60 years of age and for those with preexisting CNS disease (70% risk). Many of the acute extrapyramidal adverse effects are reversible if the drug is stopped or if anticholinergic agents are given.^{4,5,28}

Tardive dyskinesia is the most common late extrapyramidal adverse effect associated with the use of antipsychotic drugs.^{4,5,28} It usually occurs after antipsychotic medication has been used for several years. The chief sign is involuntary movements of the lips, tongue, mouth, jaw, upper and lower extremities, or trunk. Classic tardive dyskinesia affects the buccal, lingual, and masticatory muscles, leading to “flycatcher’s tongue,” “bon-bon sign,” grimaces, or chewing movements. Flycatcher’s tongue refers to darting of the tongue into and out of the mouth. The bon-bon sign is the pushing of the tongue against the cheek wall so that it looks as though a piece of candy is pressed against the cheek. An early sign of tardive dyskinesia is wormlike movement of the tongue within the mouth. Tardive dyskinesia develops in about 20% of patients with schizophrenia who receive antipsychotics over a period of years. Patients treated with such agents will develop tardive dyskinesia at the rate of about 4% per year. Older adult patients appear to be at much higher risk for the development of tardive dyskinesia early in their treatment.^{25,29,30}

Additional adverse effects of the anticholinergic antipsychotic drugs include hormone-related changes, postural hypotension, and photosensitivity (see Table 29.9). Orthostatic hypotension is a potentially serious adverse effect that is most common with low-potency agents. Dehydrated patients are at greatest risk for this complication.^{4,5,29}

Several atypical antipsychotic drugs, including clozapine (Clozaril), risperidone (Risperdal), olanzapine (Zyprexa), and quetiapine (Seroquel), are available for the treatment of schizophrenia. Clozapine does not cause extrapyramidal adverse effects or carry a risk for tardive dyskinesia. It also can be effective for decreasing the negative symptoms of schizophrenia. Unfortunately, use of clozapine is associated with a 1% to 2% incidence of agranulocytosis. Patients treated with clozapine must be monitored every 4 weeks with complete blood cell counts. Clozapine is effective in some patients with schizophrenia who do not respond to standard antipsychotic drugs. Risperidone is a combined serotonin–dopamine antagonist. In contrast with the standard neuroleptics, which have little or no effect on the “negative” symptoms, risperidone is effective for both “negative” and “positive” symptoms of schizophrenia.

All of the atypical antipsychotics have a lower affinity for binding to D₂ dopamine receptors and a lower risk for extrapyramidal adverse effects.^{23,28,29}

Important drug interactions may occur in patients who are being treated with antipsychotic drugs (Table 29.10). When neuroleptic drugs are used with TCAs or antiparkinsonian drugs, a powerful anticholinergic effect may result.^{23,29}

Malignant neuroleptic syndrome represents a rare but very serious adverse effect of antipsychotic drugs. This syndrome combines autonomic dysfunction, extrapyramidal dysfunction, and hyperthermia. The patient develops tachycardia, labile blood pressure, dyspnea, masked facies, tremors, muscle rigidity, catatonic behavior, dystonia, and marked elevation in temperature (up to 106°F). The syndrome was first reported in 1960; since that time, more than 200 cases have been described. It occurs after neuroleptic drugs are given in therapeutic doses. Malignant neuroleptic syndrome is most common in young men with mood disorders. Symptoms continue 5 to 10 days after the drug has been stopped. Reported mortality rates range from 10% to 20%. Treatment consists of stopping all neuroleptic medication, body cooling, rehydration, and treatment with bromocriptine (a dopamine agonist).^{4,13,23,29}

DENTAL MANAGEMENT

Medical Considerations

Depression. During a deep depressive episode, significant impairment of all personal hygiene, including a total lack

of oral hygiene, is likely. Salivary flow may be reduced because of the medications, and patients may report dry mouth (xerostomia), with an increased rate of dental caries and periodontal disease. In addition, complaints of glossodynia and various facial pain syndromes are common.³¹

Signs of low-grade chronic depression include tiredness even after getting enough sleep; difficulty getting up in the morning; restlessness; loss of interest in family, work, and sex; inability to make decisions; anger and resentment; chronic complaining; self-criticism; feelings of inferiority; and excessive daydreaming. Signs of more severe depression include excessive crying, change in sleeping habits, a sense of nausea precipitated by thoughts of food, weight loss without dieting, strong feelings of guilt, nightmares, thoughts about suicide, feeling unreal or in a “fog,” and an inability to concentrate.³¹

Only small amounts of epinephrine should be used in local anesthesia because more concentrated forms of epinephrine can cause severe hypertension when given to patients on antidepressive drugs. Sedative medication may have to be given in reduced dosages to avoid overdepression of the CNS. No medical contraindication to dental treatment during a depressive episode has been recognized. Most depressed patients, however, may be best served by addressing only their immediate dental needs during the depressive episode. When the patient has responded to medical treatment, more complex dental procedures can be performed³¹ (Box 29.2).

Patients with severe depression must be referred for medical evaluation and treatment. If the patient is not responsive to this recommendation, the problem should be shared with a family member and every attempt made to get the affected person in for medical attention. During severe depression, suicide is an ever-possible outcome, and dental providers should be aware that medical treatment can reduce this possibility.³¹

Bipolar Disorder. From a dental standpoint, lithium, which is used to manage bipolar disorders, can cause xerostomia and stomatitis. There are limited adverse drug interactions that occur between lithium and agents used in dentistry. These include concurrent use of NSAIDs or erythromycin, both of which can cause lithium toxicity.²⁶

Patients who do not respond to lithium and those who can no longer take lithium usually are treated with a phenothiazine type of drug. Phenothiazines can cause bone marrow suppression and fluctuations in blood pressure. The dentist must be aware of these adverse effects and should examine the patient for signs of thrombocytopenia and leukopenia (see Chapters 23 and 24), which can lead to serious problems with infection or excessive bleeding. Phenothiazine drugs potentiate the sedative action of sedative medications, and serious respiratory depression may result with use of these agents at normal dosage. Therefore, if these agents must be used, the dosage must be reduced. The dentist should consult

TABLE 29.10 Significant Drug Interactions With Antipsychotic (AP) Agents

Interacting Drug or Drug Class	Complication
Alcohol	Increases risk of hypotension and respiratory depression
Anesthetics	Increase risk of hypotension
Antiarrhythmics	Increase risk of arrhythmias
Anticonvulsants	Reduce effects of AP drug
Tricyclic antidepressants	The AP drug will increase the serum level of the tricyclic agent
Antihypertensives	Increase risk of hypotension
Anxiolytics	Increase risk of sedation
Cimetidine	Increase risk of respiratory depression
Opioids	Increases the antipsychotic effects of the AP drug
Erythromycin	Increase the sedative effects of the opioids
Sympathomimetics (epinephrine)	Increase risk of respiratory depression
	Increases the serum level of the AP drug, risk of convulsions
	Increase risk of hypotension

BOX 29.2 Dental Management Considerations in Patients With Depression, Bipolar Disorder, and Schizophrenia

P Patient Evaluation and Risk Assessment (see Box 1.1) <ul style="list-style-type: none"> Evaluate and determine whether psychiatric disorder exists. Obtain medical consultation if patient's condition is poorly controlled, if signs and symptoms point to undiagnosed condition, or if diagnosis is uncertain. 		Consultation Patient's physician should be consulted to confirm medications and the status of control of the illness. Elective dental treatment may have to be deferred for patients with severe symptoms of mania, depression, or schizophrenia until the condition is better controlled. Confirm the need to reduce the dosage of drugs required in management of the patient's dental problems. If severe xerostomia is found, request the physician to change medication if possible. Refer patients found to have chronic extramedullary movement complications related to antipsychotic medications.
Potential Issues and Factors of Concern		
A		
Analgesics	Avoid sedative agents or use in reduced dosage (see drugs) in patients taking antidepressant or antipsychotic drugs.	
Anesthesia	Use of epinephrine should be limited in patients taking antidepressants or antipsychotic drugs because hypertensive reaction (with antidepressants) or hypotensive reaction (with antipsychotics) can occur. Limit to two cartridges of 1:100,000 epinephrine (also avoid more concentrated forms of epinephrine in retraction cord or used to control bleeding).	
Antibiotics	Not indicated unless acute infection is present	
Anxiety	No issues	
B		
Bleeding	Thrombocytopenia and leukopenia may occur as side effects of medications used to treat these patients. Examine for signs of these conditions.	
Breathing	No issues	
Blood pressure	Check blood pressure because hypotension may occur as result of some medications (antidepressant and antipsychotic drugs).	
C		
Cardiovascular	No issues	
Chair position	Patients taking TCAs or MAO inhibitors may be prone to postural hypotension with sudden changes in chair position. Support patient getting out of the dental chair.	
D		
Devices	No issues	
Drugs	Avoid or use in reduced dosage sedatives, hypnotics, and narcotic agents in patients taking antidepressants or antipsychotic drugs. Avoid NSAIDs, tetracycline, and metronidazole in patients taking lithium because lithium toxicity may occur. Also, diazepam should be avoided because hypothermia may occur. Some psychiatric drugs may cause xerostomia.	
E		
Emergencies	With patients who are depressed and have shared thoughts of suicide, a relative and the patient's physician should be contacted immediately.	
Equipment	No issues	
F		
Follow-up	Ensure that patient is seeking routine follow-up for the condition.	

MAO, Monoamine oxidase; NSAID, nonsteroidal antiinflammatory drug; TCA, tricyclic antidepressant.

with the patient's physician regarding this point. Epinephrine used in normal amounts in local anesthetic solutions (1:100,000) usually will not produce adverse effects in patients who are taking phenothiazine-type drugs (see Box 29.2).^{26,32}

Somatoform Disorder. The characteristics of a somatoform disorder include the following:

- No identifiable lesion or pathologic condition can be found.
- The disorder or reaction has an emotional cause.
- The disorder is not dangerous to the patient.
- The disorder is a defense for the patient in terms of reducing the level of anxiety.

Reducing anxiety by converting it into a symptom is called *primary gain*. Patients also may have *secondary gains* as a result of their condition—for example, because of their symptoms, they may not be able to work, or they may receive increased attention from their family.

Examples of oral symptoms that can be produced by somatoform disorders are burning tongue, painful tongue, numbness of soft tissue, tingling sensations of oral tissues, and pain in the facial region. The diagnosis of a somatoform disorder should be made only after the following criteria have been met: (1) A thorough search from a clinical standpoint has failed to provide any evidence of a disease process that could explain the symptoms; (2) the symptoms have been present long enough that if they

were related to a disease process, a lesion would have developed; (3) symptom localization does not reflect known anatomic distribution of nerves; and (4) underlying systemic conditions that could produce the symptoms have been ruled out by laboratory tests or by referral to a physician. Systemic conditions that must be ruled out because of potential overlapping features include anemia, diabetes, cancer, and a nutritional deficiency (vitamin B complex).^{23,32}

The process of establishing the diagnosis of somatoform disorders is slow and time consuming. Dental treatment should not be provided on the basis of a patient's symptoms unless a dental cause can be found. Many patients have undergone needless extractions, root canal treatments, and other procedures in an attempt to address somatoform symptoms. Complex dental care should not be attempted until the somatoform problem has been appropriately managed. The diagnosis of a somatoform disorder should not be reached until a thorough search has been made over time that fails to uncover pathologic findings that could explain the symptoms.

Dentists should pay close attention to their feelings toward the patient. Symptoms may be viewed only as a device to gain attention and sympathy, and this may cause feelings of hostility and anger on the part of the dentist, which will not enhance proper management of the patient. The dentist should be empathetic toward the patient, try to understand the cause of the problem, and display a positive manner. An attempt should be made by the dentist to provide effective management for the patient with a mild somatoform disorder (mild in the sense that the patient remains able to function at a reasonable level, the patient's psychoaffective status appears to be stable, and the patient has shown or expressed no suicidal tendencies). Such patients should be assured that they do not have a life-threatening disease such as cancer. A series of regular short appointments should be scheduled to reexamine the patient for possible signs of disease, to discuss symptoms, and to provide reassurance that tissue changes are not clinically evident.

Patients with a severe somatoform disorder should be referred to a psychiatrist; however, after a patient has been referred, the dentist should be willing to remain involved. The patient may need to be reexamined and the psychiatrist consulted regarding the findings. If patients feel that the dentist only wants to "get rid of them," the suggestion of referral will not be helpful or effective.

Schizophrenia. Consultation with the patient's physician is recommended before dental treatment is started to establish the patient's current status, medications the patient is taking, and the ability of the patient to give valid consent for treatment.³³ It is suggested that the dentist ask the psychiatrist's opinion regarding the patient's medicolegal competence to sign a consent form.³⁴ Also, the dentist should inquire about the ability of the patient to perform preventive hygiene procedures.³³ Routine dental treatment of the patient should not be attempted unless

the patient is under medical management. Even then, these patients may be difficult to manage. An attendant or family member should accompany the patient to maximize comfort and familiarity. Patients should be scheduled for morning appointments.

Preventive dental education is important, although the importance of good oral hygiene and appropriate technique is more difficult to convey to this group of patients. Oral instructions, modeled demonstrations (hygienist brushes and flosses his or her own teeth), and descriptive posters showing proper toothbrushing and flossing techniques can be used to communicate to the patient what needs to be done and how.³¹ For patients who are not able to perform oral hygiene procedures or who lack the motivation, a family member or attendant should be instructed on the procedures. The dentist may use artificial saliva products, antimicrobial agents (chlorhexidine gluconate), and fluoride mouth products to promote good oral hygiene.³³ Patients should be recalled at 3-month intervals for examination, oral prophylaxis, and application of a fluoride gel or varnish.³³

Confrontation and an authoritative attitude on the part of the dentist should be avoided. If the standard approach does not allow for proper dental management, the dentist should consider sedation or tranquilization, which should be provided in consultation with the patient's physician. Chlorpromazine (Thorazine), chloral hydrate, diazepam (Valium), or oxazepam may be considered.^{34,35} Antipsychotic medications may add or potentiate the actions of other CNS depressants such as narcotic analgesics and barbiturates. When these agents are used, caution must be exercised to avoid excessive CNS depression, hypotension, orthostatic hypotension, and respiratory depression. Epinephrine at higher doses must be avoided in patients taking antipsychotic drugs because severe hypotension may result. The small amount of epinephrine used in local anesthetics is safe, but more concentrated forms of the drug should not be used. Patients who are treated with clozapine can develop bone marrow suppression; the most recent white blood cell count should be reviewed before dental treatment is started.³³

Suicidal Patients. Suicide is one of the leading causes of death among persons younger than 45 years of age. It also is far too common in the elderly population. Since 1980, a dramatic increase has occurred in the rate of suicide in persons 5 to 19 years of age and in persons 65 years or older. In fact, in some countries, the suicide rate has increased by 60% during the past 45 years.²⁰ Men are three times more successful in their suicide attempts than women. However, women are 10 times more likely to attempt suicide. The most common methods of suicide include hanging, overdose of medication or poison, carbon monoxide poisoning through car exhaust systems, jumping from a height (building, cliff), jumping in front of a moving vehicle, and the use of firearms²⁰ (Fig. 29.4).

Patients with suicidal symptoms often say that they feel frustrated, helpless, or hopeless. They frequently are



FIG 29.4 In the United States during 2001, about 55% of all suicides were committed with the use of firearms.

angry, self-punishing, and harshly self-critical. The potential for suicide is high among persons who suffer from any of the following conditions: chronic physical illness, alcoholism, drug abuse, and depression. Suicide statistics show that men, adolescents, and older adults are at greatest risk. A history of a previous suicide attempt greatly increases the risk, as does a history of recent psychiatric hospitalization. Recent diagnosis of a serious condition such as cancer or AIDS also may increase the risk of suicide. The recent loss of a loved one or recent retirement may increase this risk as well. Occurrence of any of these events is associated with increased risk for suicide in people who live alone or have little or no social support. Patients most likely to attempt or complete suicide are those who are perturbed, who state a plan for suicide, and who have the means to carry it out.^{20,36}

The dentist should ask whether the very depressed patient has had any thoughts about suicide. Studies have shown that questions about suicide do not prompt the act in these patients. Patients who state they have had these thoughts must be referred for immediate medical care. If possible, members of the family should get involved.^{20,31}

Drug Interactions and Adverse Effects

Tricyclic Antidepressants. Many of the heterocyclic antidepressants can cause hypotension, orthostatic hypotension, tachycardia, and cardiac arrhythmia. When sedatives, hypnotics, barbiturates, and narcotics are used together with the heterocyclic antidepressants, severe respiratory depression may result. If these agents must be used, the dosage should be reduced. Atropine should be used with care in these patients because it may increase intraocular pressure. Small amounts of epinephrine (1:100,000) can be used in patients who are taking heterocyclic antidepressants if the dentist aspirates before

injecting and injects the anesthetic slowly. No more than two cartridges should be injected at any appointment (see [Box 29.2](#)). Other, more concentrated forms of epinephrine must be avoided.^{11,20,30,31,37}

Monoamine Oxidase Inhibitors. Patients who are taking MAO inhibitors can receive small amounts of epinephrine in local anesthetics. Other forms of epinephrine (retraction cord, topical for control of bleeding) are best avoided. Phenylephrine must not be used in patients who are taking MAO inhibitors. MAO inhibitors may interact with sedatives, narcotics, nonnarcotic analgesics, antihistamines, and atropine to prolong and intensify their effects on the CNS (see [Table 29.7](#)).^{11,30,37}

Antipsychotic Drugs. Several important drug interactions may occur in patients who are taking neuroleptic drugs. Anticonvulsants such as phenobarbital decrease the effectiveness of the antipsychotics. TCAs can result in increased plasma concentrations of either agent, which can result in clinical symptoms due to either agent. Thus, extreme care is indicated with use of sedatives, hypnotics, antihistamines, and opioids in patients who are taking neuroleptic agents, which will increase the respiratory depressant effects of these drugs. This potentiation can be dangerous, particularly in patients with compromised respiratory function. If these types of drugs must be used, the dosage must be reduced. The dentist should always consult with the patient's physician or check a drug interaction resource (website, textbook) before using these agents.^{27,30,37}

Epinephrine must be used with great care in patients who are receiving a neuroleptic drug because a severe hypotensive episode may result. Small amounts of epinephrine (1:100,000) can be used in patients who are taking neuroleptic drugs if the dentist aspirates before injecting; injects the anesthetic solution slowly; and, in general, uses no more than two cartridges. Use of epinephrine-impregnated retraction cord or as a topically applied agent for control of bleeding is contraindicated (see [Box 29.2](#)).

With older patients who are taking antipsychotic drugs, several important problems arise in terms of drug usage. These patients usually have decreased levels of serum albumin; hence, many of them have a higher percentage of the drug in an unbound state. This free drug increases the risk for toxic reactions. In addition, many of these patients have marginal liver function; hence, drugs metabolized by the liver may remain in the circulation for longer periods and in increased concentrations.

Treatment Planning Considerations

The goals of treatment planning for patients with psychiatric disorders are to maintain oral health, comfort, and function and to prevent and control oral disease. Without an aggressive approach to prevention, many of these patients will be susceptible to dental caries and periodontal disease. Susceptibility to such diseases increases because of the adverse effect of xerostomia, which is



FIG 29.5 Agranulocytosis. The dentist should be aware that agranulocytosis may be associated with the drugs used to treat psychoses. (From Sapp JP, Eversole LR, Wysocki GP: *Contemporary oral and maxillofacial pathology*, ed 2, St. Louis, 2004, Mosby.)

associated with most of these medications, and the fact that some of the psychiatric conditions for which these patients are being treated are associated with reduced interest in performing or impaired ability to perform oral hygiene procedures. Also, many of these patients consume an improper diet containing foods or drinks that increase the risk for dental disease.³¹

The dental team should communicate to the patient and family members a positive, hopeful attitude toward maintenance of the patient's oral health. The dental team should determine whether the patient is legally able to make rational decisions. This issue should be discussed with the patient and a close relative or spouse. Treatment planning often involves input and permission from a significant other so that decisions can be made.

Oral Complications and Manifestations

Antipsychotic drugs may cause agranulocytosis, leukopenia, or thrombocytopenia. Oral lesions associated with these reactions may occur. If the dentist notes oral lesions, fever, or sore throat in a patient who is taking antipsychotic drugs, the patient must be evaluated for possible agranulocytosis. The mood-stabilizing drugs—carbamazepine and valproate—also may cause agranulocytosis, leukopenia, or thrombocytopenia (Fig. 29.5).

Patients who are taking antipsychotic agents may develop muscular problems (dystonia, dyskinesia, or tardive dyskinesia) in the oral and facial regions. If the dentist observes such initial symptoms of dysfunction, the patient should be referred to the primary care physician or psychiatrist for evaluation and appropriate management.²⁷

Patients with psychiatric disorders may engage in painful self-destructive acts. Acts of orofacial mutilation such as eye gouging, pushing sharp objects into the ear canal, lip biting, cheek biting, tongue biting, burning of oral tissues with the tip of a cigarette, and mucosal injury with a sharp or blunt object have been reported.

Patients with severe psychiatric disorders may not have an interest in caring for themselves or the ability to do so. Hence, oral hygiene is poor, and increased dental problems develop. Most of the medications used to treat psychiatric disorders contribute to increased dental problems in such patients because xerostomia is one of their primary adverse effects. This unfavorable oral environment may create conditions, leading to an increased incidence of smooth-surface caries and candidiasis. Stiefel and colleagues³⁸ reported on the oral health of persons with and without chronic mental illness in community settings. Patients with chronic mental illness were found to have a significantly greater incidence of dry mouth, mucosal lesions, and coronal smooth-surface caries, as well as increased severity of plaque and calculus buildup.

REFERENCES

1. Association AP. *Diagnostic and Statistical Manual of Mental Disorders (DSM-5TM)*. 5th ed. Arlington, VA: American Psychiatric Publishing; 2013:1-947.
2. Schiffer RB. Psychiatric disorders in medical practice. In: Goldman L, Ausiello D, eds. *Cecil Textbook of Medicine*. Philadelphia Saunders; 2004:2212-2222.
3. Cleare A. Unipolar depression. In: Wright P, Stern J, Phelan M, eds. *Core Psychiatry*. 2nd ed. Edinburgh: Elsevier; 2005:271-295.
4. Reus VI. Mental disorders. In: Fauci AS, ed. *Harrison's Principles of Internal Medicine*. 17th ed. New York: McGraw-Hill; 2008:2710-2723.
5. Schiffer RB. Psychiatric disorders in medical practice. In: Goldman L, Ausiello D, eds. *Cecil Medicine*. 23rd ed. Philadelphia: Saunders Elsevier; 2008:2628-2638.
6. Shah A, Tovey E. Psychiatry of old age. In: Wright P, Stern J, Phelan M, eds. *Core Psychiatry*. 2nd ed. Edinburgh: Elsevier; 2005:481-493.
7. Giglio JA, Laskin DM. Prevalence of psychiatric disorders in a group of adult patients seeking general dental care. *Quintessence Int*. 2010;41(5):433-437.
8. Association AP. DSM-IV Classification. In: *Diagnostic and Statistical Manual of Mental Disorders (DSM-IV-TR)*. 4th ed. Washington DC: American Psychiatric Association; 2000:13-24.
9. Khalife S. Bipolar disorder. In: Carey WD, ed. *Current Clinical Medicine 2009*. Cleveland Clinic Philadelphia: Saunders Elsevier; 2009:1007-1012.
10. McFadden WC, Jaffe AE, Ye T, et al. Assessment of genetic risk for distribution of total interstitial white matter neurons in dorsolateral prefrontal cortex: role in schizophrenia. *Schizophr Res*. 2016;176(2-3):141-143.
11. Scherger J, Sudak D, Alici-Evciment Y. Depression. Elsevier 2006. <http://www.firstconsult.com/depression>. Accessed 25 March 2006.

12. Tesar GE. Recognition and treatment of depression. In: Carey WD, ed. *Current Clinical Medicine 2009 - Cleveland Clinic*. Cleveland Clinic Philadelphia: Saunders Elsevier; 2009:997-1006.
13. American Psychiatric Association. Schizophrenia and other Psychotic Disorders. In: *Diagnostic and Statistical Manual of Mental Disorders (DSM-IV-TR)*. 4th ed. Washington DC: American Psychiatric Association; 2000:297-345.
14. Scherger JE, Baustian GH, O'Hanlon KM, et al. Bipolar Disorders. Elsevier 2006. <http://www.firstconsult.com/bipolardisorders>. Accessed 29 March 2006.
15. Kahn DA. Mood Disorders. In: Cutler JL, Marcus ER, eds. *Saunders Text and Review Series: Psychiatry*. Philadelphia: W.B. Saunders Company; 1999:34-63.
16. Rush AJ, Trivedi MH, Wisniewski SR, et al. Bupropion-SR, sertraline, or venlafaxine-XR after failure of SSRIs for depression. *N Engl J Med*. 2006;354(12):1231-1242.
17. Tseng MC, Chang CH, Chen KY, et al. Prevalence and correlates of bipolar disorders in patients with eating disorders. *J Affect Disord*. 2016;190:599-606.
18. Healy D. *Psychiatric Drugs Explained*. 5th ed. St. Louis: Churchill Livingstone Elsevier; 2009.
19. Trevino K, McClintock SM, Husain MM. A review of continuation electroconvulsive therapy: application, safety, and efficacy. *J ECT*. 2010;26(3):186-195.
20. Srinath S. Suicide and deliberate self-harm. In: Wright P, Stern J, Phelan M, eds. *Core Psychiatry*. 2nd ed. Edinburgh: Elsevier; 2005:319-335.
21. Koburger N, Mergl R, Rummel-Kluge C, et al. Celebrity suicide on the railway network: can one case trigger international effects? *J Affect Disord*. 2015;185:38-46.
22. American Psychiatric Association. Schizophrenia Spectrum and Other Psychotic Disorders. In: *Diagnostic and Statistical Manual of Mental Disorders (DSM-5TM)*. 5th ed. Arlington, VA: American Psychiatric Publishing; 2013:87-122.
23. Wright P. Schizophrenia and related disorders. In: Wright P, Stern J, Phelan M, eds. *Core Psychiatry*. 2nd ed. Edinburgh: Elsevier; 2005:241-267.
24. Calcaterra NE, Hoepfner DJ, Wei H, et al. Schizophrenia-associated hERG channel Kv11.1-3.1 exhibits a unique trafficking deficit that is rescued through proteasome inhibition for high throughput screening. *Sci Rep*. 2016;6:19976.
25. Horwath E, Courinos F. Schizophrenia and other psychotic disorders. In: Cutler JL, Marcus ER, eds. *Saunders Text and Review Series: Psychiatry*. Philadelphia: W.B. Saunders Company; 1999:64-80.
26. Wright P, Perahia D. Psychopharmacology. In: Wright P, Stern J, Phelan M, eds. *Core Psychiatry*. 2nd ed. Edinburgh: Elsevier; 2005:579-611.
27. Pollack EF, Baustian GH, Jones RC, et al. Schizophrenia. Elsevier, 2006. <http://www.firstconsult.com/schizophrenia>. Accessed 26 March 2006.
28. Mathews M, Tesar GE, Fattal O, et al. Schizophrenia and acute psychosis. In: Carey WD, ed. *Current Clinical Medicine 2009 - Cleveland Clinic*. Philadelphia: Saunders Elsevier; 2009:1027-1036.
29. Branford D. Schizophrenia. In: Walker R, Edwards C, eds. *Clinical Pharmacy and Therapeutics*. 2nd ed. London: Churchill Livingstone; 1999:425-435.
30. Russakoff LM. Psychopharmacology. In: Cutler JL, Marcus ER, eds. *Saunders Text and Review Series: Psychiatry*. Philadelphia: W.B. Saunders Company; 1999:308-331.
31. Little JW. Dental implications of mood disorders. *Gen Dent*. 2004;52(5):442-450.
32. Goldberg RJ. *Practical Guide to the Care of the Psychiatric Patient*. St Louis: Mosby; 1995.
33. Friedlander AH, Marder SR. The psychopathology, medical management and dental implications of schizophrenia. *J Am Dent Assoc*. 2002;133(5):603-610, quiz 24-5.
34. Scully C, Cawson RA. *Medical Problems in Dentistry*. 5th ed. Edinburgh: Elsevier (Churchill Livingstone); 2005.
35. Friedlander AH, Brill NQ. Dental management of patients with schizophrenia. *Spec Care Dentist*. 1986;6(5):217-219.
36. Feinstein RE. Suicide and violence. In: Cutler JL, Marcus ER, eds. *Saunders Text and Review Series: Psychiatry*. Philadelphia: W.B. Saunders Company; 1999:201-221.
37. Felpel LP. Psychopharmacology: antipsychotics and antidepressants. In: Yagiela JA, Neidle EA, Dowd FJ, eds. *Pharmacology and Therapeutics for Dentistry*. 4th ed. St. Louis: Mosby; 1998:151-168.
38. Stiefel DJ, Truelove EL, Menard TW, et al. A comparison of oral health of persons with and without chronic mental illness in community settings. *Spec Care Dentist*. 1990;10(1):6-12.

Drug and Alcohol Abuse

The abusive use of drugs and alcohol is a huge and growing public health problem in the United States, as well as in many other countries worldwide. Drug and alcohol abuse has far-reaching effects on persons engaging in such activity, as well as their families and communities, with a consequent heavy impact on law enforcement, the judicial system, politics, and health care. It is inevitable that dental practitioners will encounter abusers of drugs and alcohol among their patients, and, unfortunately, some practitioners will themselves turn to such abuse. This chapter discusses the effects of drug and alcohol abuse as they pertain to dental management. Another legal drug of abuse, nicotine, is discussed in [Chapter 8](#).

COMPLICATIONS: Patients who have substance abuse problems may be unable to function in the workplace and have increased risk in hazardous situations, increased risk of liver disease and excessive bleeding, respiratory depression, infectious diseases, overdoses, death, and increased risk of suicide.

DEFINITIONS

According to the *Diagnostic and Statistical Manual of Mental Disorders*, fourth edition (DSM-IV), of the American Psychiatric Association,^{1,2} a diagnosis of *substance abuse* requires the recurrent use of a substance over the past 12 months with subsequent adverse consequences (e.g., failure to fulfill a major role at work, school, or home; legal problems; persistent interpersonal problems) or placement of the affected person in high-risk physically hazardous situations. *Dependence* involves tolerance and withdrawal in addition to certain patterns of drug use, the effect on life activities, and the uncontrollable need for use of the substance despite adverse consequences. *Tolerance* is defined as either a need for increased amounts of a substance to achieve the desired effect or a diminished effect with continued use of the same amount of the substance. *Withdrawal* is manifested by a characteristic syndrome emerging upon abstinence from a habitually used substance. There is confusion over the use of the term *addiction*. *Addiction* is equated with *dependence* in the DSM-IV. Some authors, however, advocate separating the terms *dependence* and *addiction*, with *addiction* being a distinct disease characterized by compulsive substance use despite serious negative consequences.^{3,4} Tolerance,

dependence, and withdrawal all *may* occur with addiction but are not necessary for the diagnosis. In addition, addicted persons remain at high risk for relapse long after detoxification and the cessation of withdrawal symptoms.

Alcoholism is a term commonly used to describe a condition of substance abuse focused on consumption of alcohol. A more precise definition, however, has been proposed by O’Conner: “a primary chronic disease with genetic, psychosocial, and environmental factors ... often progressive and fatal ... characterized by impaired control over drinking, preoccupation with the drug alcohol, use of alcohol despite future consequences, and distortions of thinking, most notably denial.”⁵ It is estimated that as many as 92% of people with alcohol use disorders also smoke tobacco.⁶ Gender differences in drug abuse occur, and it is more evident in adults than adolescents. Adult men are two to three times more likely than women to develop drug abuse or dependence disorders and about four times as likely to have alcohol use disorder.⁷

EPIDEMIOLOGY

Illicit drugs of abuse include marijuana and hashish, heroin, cocaine (including crack), methamphetamine and its analogues, so-called club drugs, hallucinogens, and dissociative drugs ([Table 30.1](#)). Legally prescribed opioids and sedative-hypnotics are abused when used nonmedically. Alcohol is legal but is abused when consumed inappropriately or in excessive amounts. According to the 2009 National Survey on Drug Use and Health (NSDUH),⁸ an estimated 21.8 million Americans 12 years of age and older were current illicit drug users, which is higher than in 2008. This number represents approximately 8.7% of the population. Illicit drug use is highest among young persons 18 to 25 years of age. In a dental practice of 2000 patients, it can be expected that approximately 175 of them abuse at least one type of drug or other substance.

Based on the September 2015 report from the 2014 NSDUH,⁹ the numbers of people who initiated many substances has generally remained the same in most recent years. For example, the number of recent marijuana initiates in 2014 (2.6 million) was greater than the numbers in 2002 to 2008 but was similar to the numbers from 2009 to 2013. Recently, some states have made the use

TABLE 30.1 Most Common Illicit Drugs of Abuse

Substance of Abuse	Street Names	How Administered	Acute Effects
CANNABINOIDS			
Marijuana	Blunt, dope, ganja, grass, herb, joint, bud, Mary Jane, pot, reefer, green, trees, smoke, sinsemilla, skunk, weed	Smoked, swallowed	Euphoria; relaxation; slowed reaction time; distorted sensory perception; impaired balance and coordination; increased heart rate and appetite; impaired learning, memory; anxiety; panic attacks; psychosis or cough, frequent respiratory infections; possible mental health decline; addiction
OPIOIDS			
Heroin	Smack, horse, brown sugar, dope, H, junk, skag, skunk, white horse, China white; cheese (with OTC cold medicine and antihistamine)	Injected, smoked, snorted	Euphoria; drowsiness; impaired coordination; dizziness; confusion; nausea; sedation; feeling of heaviness in the body; slowed or arrested breathing/constipation; endocarditis; hepatitis; HIV; addiction; fatal overdose
STIMULANTS			
Cocaine	Blow, bump, C, candy, Charlie, coke, crack, flake, rock, snow, toot	Snorted, smoked, injected	Increased heart rate, blood pressure, body temperature, metabolism; feelings of exhilaration; increased energy, mental alertness; tremors; reduced appetite; irritability; anxiety; panic; paranoia; violent behavior; psychosis or weight loss, insomnia; cardiac or cardiovascular complications; stroke; seizures; addiction Cocaine—also nasal damage from snorting
Amphetamine	Bennies, black beauties, crosses, hearts, LA turnaround, speed, truck drivers, uppers	Swallowed, snorted, smoked, injected	Methamphetamine—also severe dental problems
Methamphetamine	Meth, ice, crank, chalk, crystal, fire, glass, go fast, speed	Swallowed, snorted, smoked, injected	
CLUB DRUGS			
MDMA	Ecstasy, Adam, clarity, Eve, lover's speed, peace, uppers	Swallowed, snorted, injected	MDMA—mild hallucinogenic effects; increased tactile sensitivity; empathic feelings; lowered inhibition; anxiety; chills; sweating; teeth clenching; muscle cramping or sleep disturbances; depression; impaired memory; hyperthermia; addiction
Flunitrazepam	Forget-me pill, Mexican Valium, R2, roach, Roche, roofies, roofinol, rope, rophies	Swallowed, snorted	Flunitrazepam—sedation; muscle relaxation; confusion; memory loss; dizziness; impaired coordination/addiction
GHB	G, Georgia home boy, grievous bodily harm, liquid ecstasy, soap, scoop, goop, liquid X	Swallowed	GHB—drowsiness; nausea; headache; disorientation; loss of coordination; memory loss or unconsciousness; seizures; coma
DISSOCIATIVE DRUGS			
Ketamine	Cat, Valium, K, Special K, vitamin K	Injected, snorted, smoked	Feelings of being separate from one's body and environment; impaired motor function or anxiety; tremors; numbness; memory loss; nausea
PCP and analogues	Angel dust, boat, hog, love boat, peace pill	Swallowed, smoked, injected	Ketamine—also analgesia; impaired memory; delirium; respiratory depression and arrest; death PCP and analogues—also analgesia; psychosis; aggression; violence; slurred speech; loss of coordination; hallucinations

TABLE 30.1 Most Common Illicit Drugs of Abuse—cont'd

Substance of Abuse	Street Names	How Administered	Acute Effects
HALLUCINOGENS			
LSD	Acid, blotter, cubes, microdot yellow sunshine, blue heaven	Swallowed, absorbed through oral mucosa	Altered states of perception and feeling; hallucinations; nausea LSD and mescaline—also increased body temperature, heart rate, blood pressure; loss of appetite; sweating; sleeplessness; numbness, dizziness, weakness, tremors; impulsive behavior; rapid shifts in emotion LSD—also flashbacks, hallucinogen, persisting perception disorder
Mescaline	Buttons, cactus, mesc, peyote	Swallowed, smoked	

GHB, γ -Hydroxybutyrate; *LSD*, lysergic acid diethylamide; *PCP*, phencyclidine.

Adapted from the National Institutes of Health, National Institute on Drug Abuse (website), <http://www.drugabuse.gov/DrugPages/DrugsOfAbuse.html>; accessed on March 3, 2011.

of marijuana legal (Colorado, Washington, Oregon, and Alaska), and other states have made marijuana use for medical purposes acceptable.¹⁰⁻¹²

In the context of the entire United States, marijuana is still the most commonly used “illicit” drug. In 2009, there were 16.7 million past-month users. Among persons aged 12 or older, the rate of past-month marijuana use and the number of users in 2009 (6.6%, or 16.7 million) were higher than in 2008 (6.1%, or 15.2 million) and in 2007 (5.8%, or 14.4 million). In 2009, there were 1.6 million current cocaine users aged 12 or older, comprising 0.7% of the population. These estimates were similar to the number and rate in 2008 (1.9 million, or 0.7%) but were lower than the estimates in 2006 (2.4 million, or 1.0%). An estimated 3.7 million people have reported previous use of heroin, with an estimated 150,000 persons becoming new users every year.² The level of heroin use is relatively stable, with an approximate 1.5% annual increase. Methamphetamine is a synthetic drug that is easily manufactured, and its use is spreading across the United States at alarming rates. The number of past-month methamphetamine users decreased between 2006 and 2008 but then increased in 2009. The reported figures were 731,000 (0.3%) in 2006, 529,000 (0.2%) in 2007, 314,000 (0.1%) in 2008, and 502,000 (0.2%) in 2009.

The use of prescription opioids (e.g., OxyContin) for nonmedical reasons is currently one of the fastest growing dimensions of drug abuse in the United States, with a 225% increase from 1992 to 2000.² The lifetime nonmedical use of OxyContin increased from 1.9 million to 3.1 million in the 2-year period from 2002 to 2004.⁶ From 2002 to 2009, there was an increase among young adults 18 to 25 years of age in the rate of current nonmedical use of prescription-type drugs (from 5.5% to 6.3%), driven primarily by an increase in pain reliever misuse (from 4.1% to 4.8%). Opioid analgesics in high doses caused 21,314 deaths in the United States in 2011.¹³ The nonmedical use of opioids has become epidemic in certain parts of the nation, especially in regions on the east coast.

According to the National Institute on Alcohol Abuse and Alcoholism, in 2014, 87.6% of people ages 18 or older drank alcohol at some point in their lifetime, 71% reported they drank in the past year, and 56.9% drank in the past month.¹⁴ Binge drinking (consumption of five or more drinks on the same occasion) was reported by 24.7% of people 18 years old or older. Alcohol use disorder (AUD) was reported in 6.8% of these adults. Only 8.9% of adults (9.8% of men and 7.4% of women) who needed treatment for AUD received it. Nearly 88,000 people die from alcohol-related causes each year, making alcohol the fourth leading preventable cause of death in the United States. In 2014, alcohol-impaired driving fatalities accounted for 9,967 deaths (31% of overall driving fatalities).¹⁴

The prevalence of problem drinking in general outpatient and inpatient medical settings has been estimated to be between 15% and 40%.⁵ The lifetime prevalence of an alcohol use disorder in the United States is about 18.6% (13.2% for abuse and 5.4% for dependence).¹⁵ Surveys assessing past-year prevalence of these disorders indicate that nearly 8.5% (18 million) of American adults meet standard diagnostic criteria for one of the DSM-IV alcohol use disorders. Of these, 4.7% (10 million) meet criteria for alcohol abuse, and 3.8% (8 million) for dependence. Gender-specific rates of abuse and dependence differ within the general population, with men exhibiting higher rates of both abuse and dependence (8.5%) than those reported for women (4%).¹⁶ Although problem drinking is seen primarily in adults, the prevalence among teenagers is alarmingly high. Alcoholism among older adults also is a significant problem. A dental practice comprising 2000 adult patients could include as many as 170 patients who have a problem with alcohol.

Etiology

The neurobiology of addiction and dependence is complex and involves a unique set of variables. Disruption of the endogenous reward systems in the brain is a common

feature of all of the major drugs of abuse; most of these drugs act by disrupting dopamine circuits in the brain.¹⁷ Acute changes increase synaptic dopamine and disrupt circuits that mediate motivation and drive, conditioned learning, and inhibitory controls. This enhancement of synaptic dopamine is particularly rewarding for persons with abnormally low density of the D₂ dopamine receptor (D₂DR).¹⁷ A complex neural circuitry underlies the valuation and pursuit of rewards³ (Fig. 30.1). Although dopamine is the primary neurotransmitter involved in drug abuse and addiction, many other neurotransmitters are involved, depending on the drug of abuse (Fig. 30.2). Evidence suggests that inherited genetic factors are involved in alcoholism. Psychological factors such as depression, self-medication (to relieve psychic distress), personality disorder, and poor coping skills appear to be involved in addictive behavior. Social factors that may be involved include interpersonal, cultural, and societal influences.¹

CLINICAL PRESENTATION AND MEDICAL MANAGEMENT

Substance *dependence* occurs when the person using the substance takes it in larger amounts or over a longer period than was originally intended. A great deal of time may be spent in activities needed to procure the substance, take it, or recover from its effects. The person gives up important social, occupational, and recreational activities because of substance use. Marked tolerance to the

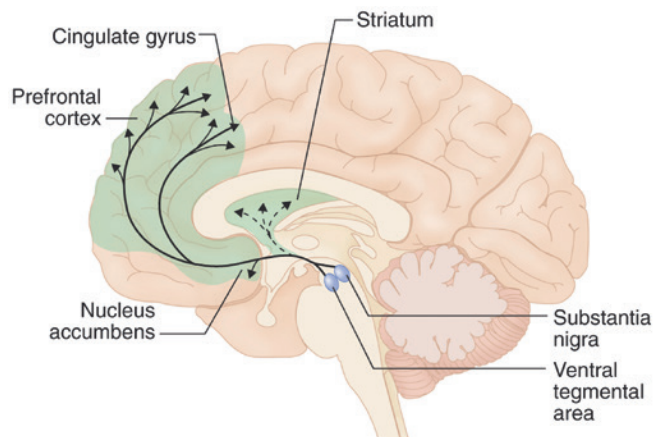

FIG 30.1 Brain reward circuits. The major dopaminergic projections to the forebrain that underlie brain reward are shown superimposed on a diagram of the human brain: projection from the ventral tegmental area to the nucleus accumbens and prefrontal cerebral cortex. Also shown are projections from the substantia nigra to the dorsal striatum, which play a role in habit formation and in well-rehearsed motor behavior, such as drug seeking and drug administration. (From Hyman SE: *Biology of addiction*. In Goldman L, Alesiello D, editors: *Cecil medicine*, ed 23, Philadelphia, 2008, Saunders.)

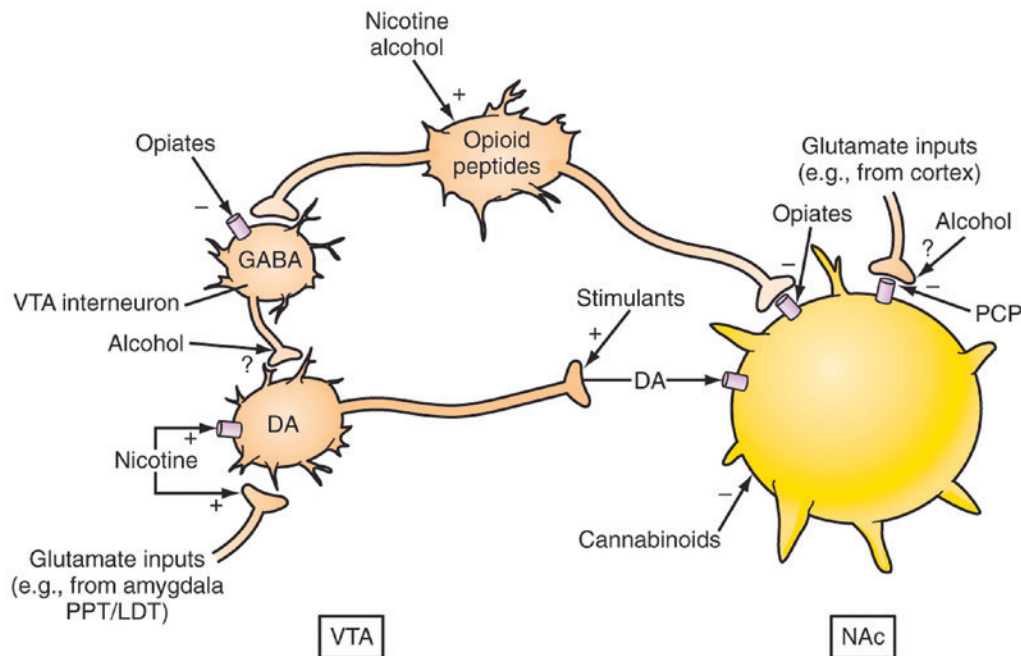

FIG 30.2 Converging acute actions of drugs of abuse on the ventral tegmental area and nucleus accumbens. DA, Dopamine; GABA, γ -aminobutyric acid; LDT, laterodorsal tegmentum; NAc, nucleus accumbens; PCP, phencyclidine; PPT, pedunculopontine tegmentum; VTA, ventral tegmental area. (From Renner JA, Ward EN: *Drug addiction*. In Stern TA, et al, editors: *Massachusetts General Hospital comprehensive clinical psychiatry*, Philadelphia, 2008, Mosby.)

substance may develop; therefore, progressively larger amounts are needed to achieve intoxication or to produce the desired effect. The person with the disorder continues to take the substance despite persistent or recurrent social, psychological, and physical problems that result from its use.^{1,2} The concept of legal highs has been introduced in the past few years.¹⁸ They include a wide range of products, from natural plant-originated substances to synthetic compounds, that can be purchased both online and from street retailers.¹⁸ “Legal highs” mimic psychoactive effects of illicit drugs of abuse. However, these substances are claimed to consist of compounds that are legal to sell, possess, and use, often labeled as “not for human consumption” to circumvent drug abuse legislation.¹⁸

Substance *abuse* denotes substance use that does not meet the criteria for dependence (Table 30.2).¹⁹ This diagnosis is most likely to be applicable to persons who have just started to take psychoactive substances. Examples of substance abuse are that of a middle-aged man who repeatedly drives his car while intoxicated (the man has no other symptoms) and that of a woman who keeps drinking even though her physician has warned her that alcohol is responsible for exacerbating the symptoms of a duodenal ulcer (she has no other symptoms).¹

Withdrawal occurs when the person with substance dependence stops or reduces intake of the substance. Withdrawal symptoms vary in accordance with the substance involved. Physiologic signs of withdrawal are common after prolonged use of alcohol, opioids, sedatives, hypnotics, and anxiolytics. Such signs are less obvious in withdrawal from cocaine, nicotine, amphetamines, and cannabis.^{1,2}

Marijuana

Marijuana is the common name for cannabis, which is the most commonly used illicit drug in the world.² Delta-9-tetrahydrocannabinol (THC) is the major psychoactive

ingredient in substances that causes cannabis dependence. Several different preparations of marijuana are available. These preparations—*bhang*, *charas*, *ganja*, and *hashish*—are known to vary in potency and quality. They usually are smoked but can be taken orally and are sometimes mixed with food. With inhalation, peak effects occur within 20 to 30 minutes; with oral ingestion, peak effects occur within 2 to 3 hours.² Currently available marijuana supplies are much more potent than those that were available in the 1960s. Anti-marijuana laws have had little effect on controlling the use of marijuana.²⁰ Most users describe an altered sense of time and distance perception. Acute intoxication may result in anxiety and paranoid ideation or frank delusions. Tolerance and physical dependence can occur, but clinical presentation of these symptoms is not common.² Marijuana use can destabilize patients whose schizophrenia is in remission. Social and occupational impairment occurs but is less severe than that seen with alcohol and cocaine use.¹ Marijuana use rarely requires medical treatment. Anxiety reactions may require treatment with benzodiazepines. Of note, some states allow the use of marijuana for medicinal purposes, and marijuana’s action on cannabinoid receptors can be of benefit in reducing pain and alleviating some types of seizures.¹⁰⁻¹²

In the United States, the degree of overlap between medical and recreational cannabis users is 86%.¹¹ Medical and recreational cannabis users favor different modes and amounts of consumption.¹¹ Only a small proportion (12%) of cannabis users consume cannabis and alcohol at the same time; consumption of both is common among recreational users.¹¹

With the shifting legal landscape of medical cannabis, different methods of cannabis administration have important public health implications.²¹ How medical marijuana laws have influenced patterns of use such as vaping and edibles compared with smoking is unclear.

TABLE 30.2 Diagnostic Criteria for Dependence and Drug Abuse

Dependence (Three or More Needed for Diagnosis)	Abuse (One or More for 12 Months Needed for Diagnosis)
<ul style="list-style-type: none"> • Tolerance • Withdrawal • The substance is often taken in larger amounts over a longer period than intended • Any unsuccessful effort or a persistent desire to cut down or control substance use • A great deal of time is spent in activities necessary to obtain the substance or to recover from its effects • Important social, occupational, or recreational activities given up or reduced because of substance use • Continued substance use despite knowledge of having had persistent or recurrent physical or psychological problems that are likely to be caused or exacerbated by the substance 	<ul style="list-style-type: none"> • Recurrent substance use resulting in failure to fulfill major role obligations at work, school, and home • Recurrent substance use in situations in which it is physically hazardous • Recurrent substance-related legal problems • Continued substance use despite having persistent or recurrent social or interpersonal problems caused or exacerbated by the effects of the substance • Never met criteria for dependence

From Samet JH: Drug abuse and dependence. In Goldman L, Ausiello D, editors: *Cecil textbook of medicine*, ed 23, Philadelphia, 2008, Saunders.

However, they appear to be related to state-level patterns of utilization of alternative methods of cannabis administration.²¹

Opioids

The primary effects of the opioids (opiate-like drugs) are to decrease pain perception, cause modest levels of sedation, and produce euphoria. Drugs in this category include those derived from naturally occurring alkaloids morphine and codeine. Semisynthetic drugs produced from morphine or thebaine molecules include hydrocodone, hydromorphone, heroin, and oxycodone. Synthetic opioids include meperidine, propoxyphene, diphenoxylate, fentanyl, buprenorphine, methadone, and pentazocine. Tolerance to any single opioid is likely to generalize to other drugs in the group.

Through direct effects on the central nervous system (CNS), opiates may produce nausea and vomiting, decreased pain perception, euphoria, and sedation. Additives in street drugs can cause permanent damage to the nervous system, including peripheral neuropathy and CNS dysfunction. Users of such drugs may experience constipation and anorexia. Respiratory depression occurs as the result of a decreased response of the brainstem to carbon dioxide tension. This effect is part of the toxic reaction to opiates, as described later on, but it also can be significant in patients with compromised lung function.

Complications are common among abusers of narcotics, especially when administered intravenously. Cardiovascular effects of the opiates are mild, and no direct effect on heart rhythm or myocardial contractility has been noted with their use. Orthostatic hypotension, probably caused by dilation of peripheral vessels, may occur. The major complication with intravenous (IV) use of these drugs involves the use of contaminated or shared needles; pathogens introduced in this manner can cause hepatitis B and C and infective endocarditis, and an association with increased risk for infection with human immunodeficiency virus (HIV) also has been noted.^{2,17} Infective endocarditis is unusual in that it predominantly affects the right side of the heart (the location of the tricuspid valve), with *Staphylococcus aureus* being the most common causative organism.²²

Dependence on opiates can be seen in at least three groups of patients. The first group is the minority of patients with chronic pain syndromes who misuse their prescribed drugs. The second group at high risk consists of physicians, dentists, nurses, and pharmacists. These persons have easy access to drugs with abuse potential.⁹ Members of the third and largest group buy their drugs on the street to get high. When persistent opiate use has been established, the outcome is often very serious. According to statistics from the Centers for Disease Control and Prevention, in 2007, painkillers killed twice as many people as cocaine and five times as many as heroin.²³ From 1999 to 2007, the number of U.S. poisoning deaths involving any opioid analgesic (e.g., oxycodone,



FIG 30.3 Narcan device. (©2017 ADAPT Pharma, Inc. NARCAN® is a registered trademark licensed to ADAPT Pharma Operations Limited. ADAPT Pharma, Inc. Radnor, PA. Adapt Pharma Inc. All rights reserved.)

methadone, hydrocodone) more than tripled, from 4041 to 14,459.

Toxic reactions (overdose) are seen with all opiates. These reactions are more frequent and dangerous with more potent drugs such as fentanyl, which is 80 to 100 times more powerful than morphine. IV overdose can lead immediately to slow, shallow respirations; bradycardia; a drop in body temperature; and lack of responsiveness to external stimulation. Emergency treatment includes support of vital signs with the use of a respirator and administration of a reversal agent such as naloxone by intramuscular or IV injection.²

Naloxone (Narcan nasal spray) is available for use (Figs. 30.3 and 30.4) to reverse the effects of an opioid overdose.^{24,25} It is recommended for all dental practices, but practically those located in areas with a high rate of opioid abuse, such as in the northeast parts of the United States.

In contrast with sedative withdrawal, withdrawal from opiates is an unpleasant but not life-threatening experience. Gastrointestinal upset, muscle cramps, rhinorrhea, and irritability are the prominent signs and symptoms. Opiate users with memory impairment or cognitive dysfunction should be assessed for HIV infection by evaluation of risk factors and blood screening of the patient after appropriate counseling has been provided.¹⁷

Cocaine

Cocaine is a stimulant and a local anesthetic with potent vasoconstrictor properties. After alcohol, it is the leading



FIG 30.4 Spray from a Narcan device. (©2017 ADAPT Pharma, Inc. NARCAN® is a registered trademark licensed to ADAPT Pharma Operations Limited. ADAPT Pharma, Inc. Radnor, PA. Adapt Pharma Inc. All rights reserved.)

drug of abuse in terms of frequency of emergency department (ED) visits, general hospital admissions, family violence, and other social problems.²⁶ Cocaine is used medically in otolaryngologic procedures as a potent topical anesthetic and is used to treat some patients with attention deficit–hyperactivity disorders.² The drug produces physiologic and behavioral effects when administered orally, intranasally (snorting), topically on mucous membranes, intravenously, or by smoking. “Crack” cocaine, which is inhaled by “freebasing” or smoking, results in much higher blood levels of cocaine than those achievable with “snorting” and is particularly addictive. Cocaine has potent pharmacologic effects on dopamine, norepinephrine, and serotonin neurons in the CNS. Cocaine has an elimination half-life of 30 minutes to 1 hour.²

Cocaine intoxication produces a sense of well-being, a heightened awareness of sensory input, anorexia, a decreased desire to sleep, restlessness, elation, grandiosity, agitation, and psychotic states (panic attack, paranoid ideation, delusions, and auditory and visual hallucinations). Acute users (people who are not major addicts but have just recently taken the drug) experience intense euphoria often associated with increased sexual desire along with improved sexual function. These rewards often are followed by a moderate to severe post-cocaine use depression that provides a strong compulsion for further cocaine use.¹⁷ Physical findings in cocaine intoxication consist of

tachycardia, cardiac arrhythmias, papillary dilation, and elevated blood pressure. Affected persons may experience headache, as well as chills, nausea, and vomiting. Needle tracks (from “skin popping”) may be found on the arms of injecting users of cocaine and heroin. Frequent, chronic, or high-dose use of cocaine can produce psychiatric states similar to acute schizophrenic episodes. Pregnant women who are chronic users of cocaine or heroin may give birth to infants who are “addicted.”

Cocaine overdose can be life threatening. Myocardial infarction, arrhythmia, stroke, respiratory arrest, and symptoms consistent with neuroleptic malignant syndrome have been associated with cocaine use. Depression is common in cocaine addicts, particularly during periods of withdrawal, and under these conditions, the drug may be taken in an attempt to commit suicide.

Cocaine abuse is treated using psychotherapy, behavioral therapy, and 12-step programs.² Acupuncture may be used for detoxification and prevention of relapse. Cocaine overdose constitutes a medical emergency requiring resuscitation in an intensive care unit. IV diazepam has been shown to be effective for control of seizures. Ventricular arrhythmias can be managed with IV propranolol. Medication is not available that is both safe and effective for cocaine detoxification or for maintenance of abstinence.¹⁷ Cocaine abusers who inject the drug are at increased risk for acquiring hepatitis B and hepatitis C and for exposure to HIV. Some IV cocaine abusers develop a pruritic rash on the chest (as an allergic reaction to a benzoic acid ester), and ester-type local anesthetics must be avoided in these patients.

Amphetamines

Amphetamine, methamphetamine, and related drugs are CNS stimulants. The primary action of these drugs is to increase synaptic dopamine by causing the release of dopamine stores into the synapse, which produces a dopamine “high” that is both more intense and longer lasting than that afforded by cocaine, lasting anywhere from 8 to 24 hours.¹⁷ Amphetamines are used clinically for weight loss and for treatment of attention deficit disorder, narcolepsy, and treatment-resistant depression. Many people develop dependence when they first use amphetamines for their appetite suppressant effects in an attempt at weight control. IV administration of amphetamine can lead to rapid development of dependence. Progressive tolerance is common in amphetamine dependence. Amphetamine use may result in the same symptoms and complications that are seen with cocaine abuse.² Fenethylamine, a theophylline derivative of amphetamine has effects similar to other amphetamine derivatives.²⁷ It was used to treat hyperactivity disorders in children, narcolepsy, and depression. It also has become a drug of abuse particularly in Arab and North African countries.²⁷

Methamphetamine (“meth”) is a potent synthetic psychostimulant form of amphetamine. It is highly addictive, and chronic use has been associated with violent

behavior. On the street, methamphetamine is referred to as “speed,” “crank,” “go,” and “zip.” The smokable form is called “ice” or “crystal.” The biologic half-life of methamphetamine is much longer than that of cocaine. Symptoms of withdrawal from methamphetamine may be more intense than those associated with cocaine. Cessation after daily use may result in severe depression with suicidal or homicidal ideation, hypersomnia, or sleeping difficulty.^{2,17}

Amphetamine analogues produce very similar signs and symptoms. Those associated with normal dosage include hyperalertness, euphoria, hyperactivity, and increased physical endurance. Higher doses of these drugs may be associated with dysphonia, headache, tachycardia, and confusion. When methamphetamine is introduced intravenously or by inhalation, a rapid, prolonged rush may result. When abused, methamphetamine can induce psychotic symptoms very similar to those of acute schizophrenia.

Amphetamines were widely abused during the 1960s by persons in the so-called counterculture movement. Amphetamine sulfate was known on the street as “speed,” “whiz,” “blues,” “bennies,” “pep pills,” “uppers,” or “splash.” It was inhaled, snorted, smoked, taken orally, or injected intravenously. In the 1980s and 1990s, cocaine became the drug of choice and methamphetamine abuse declined. However, use of methamphetamine (“meth”) and MDMA (“ecstasy”) has undergone a major resurgence among adolescents and people in their early 20s.²⁸ Stimulants (including amphetamine and methamphetamine) were involved in 10% of all illicit drug-related ED visits in 2004.⁸ Methamphetamine was made illegal in 1971, and ecstasy in 1985.²⁹ Methamphetamine is widely used in California and in some Midwestern states, where it is synthesized in “home laboratories,” putting the building’s occupants at risk for inhaling toxic fumes and combustible fires. Methamphetamine is the most widely illegally manufactured, distributed, and abused type of amphetamine.¹⁷

Medications that contain pseudoephedrine (over-the-counter [OTC] decongestants, such as Sudafed) are used by illegal home laboratory operators to produce methamphetamine. As a result, many states passed laws to make it more difficult to purchase OTC medicines that contain pseudoephedrine. In 2006, President Bush signed into law a bill that imposed strict standards on products made with pseudoephedrine and required that products be placed behind the counter; it also required that customers show identification and sign a log book and set limitations on how much of the medicine can be sold at one time.

Sedative-Hypnotics

The primary psychoactive substances used as sedatives and hypnotics are benzodiazepines (diazepam, lorazepam, temazepam) and, less commonly, barbiturates (phenobarbital, secobarbital, mephobarbital). Sedatives, hypnotics,

and anxiolytic drugs are frequently abused and are estimated to account for 35% of ED visits because of the nonmedical use or misuse of pharmaceuticals.³⁰ The benzodiazepines are now the most frequently abused of the sedative and hypnotic drugs, replacing the barbiturates, which are no longer extensively used in the clinical setting.

The proportion of users of benzodiazepines who become dependent is a function of dose, type, and duration of use. Longer use or higher dosage is more likely to lead to dependence; however, dependence also can occur when the drug is used in low doses for prolonged periods of time, as may be seen in clinical practice.² Usage that lasts between 3 and 12 months leads to dependence in 10% to 20% of users. The rate of dependency increases to 20% to 45% when benzodiazepines are used for periods longer than a year.³¹ Benzodiazepines should be prescribed cautiously for dependence-prone persons with other risk factors for drug abuse, in whom the use of these agents should be limited to no longer than 2 weeks when possible.³¹ Patients who are dependent on benzodiazepines are managed with gradual reduction in dose of the abused drug or by substitution of another long-acting sedative-hypnotic with gradual reduction in dosage.¹⁷

Withdrawal symptoms produced by benzodiazepines are similar to those caused by withdrawal from alcohol. They can occur after several weeks or longer of moderate use of the drug. Signs and symptoms of withdrawal from benzodiazepines include nausea and vomiting, weakness, autonomic hyperactivity (tachycardia and sweating), anxiety, orthostatic hypotension, tremor, loss of appetite and weight loss, tinnitus, delirium with delusions, and hallucinations.¹⁷

Alcohol

The behavioral and physiologic effects of alcohol depend on the amount of intake, its rate of increase in plasma, the presence of other drugs or medical problems, and the past experience with alcohol. Chronic use of heavy alcohol intake can result in clinically significant cognitive impairment (even when the person is sober) or distress. The pattern displayed usually is one of intermittent relapse and remission. If the disease is allowed to progress untreated, many affected persons develop other psychiatric problems (anxiety, antisocial behavior, and affective disorders), and some develop alcohol amnestic disorder and are unable to learn new material or to recall known material. Alcoholic blackouts may occur. In some patients, alcohol-induced dementia and severe personality changes develop.

The DSM-IV¹ defines *alcohol dependence* as repeated alcohol-related difficulties in at least three of seven areas of functioning. These include any combination of tolerance, withdrawal, increased intake of alcohol in greater amounts and over longer periods than intended, an inability to control use, giving up important activities to drink, spending a great deal of time pursuing alcohol use, and continued use of alcohol despite physical or psychological

consequences. Thus, a clinical diagnosis of alcohol dependence rests on the documentation of a pattern of difficulties associated with alcohol use and is not based on the quantity and frequency of alcohol consumption.

Treatment for alcohol dependence consists of three basic steps. The first is identification and intervention. A thorough physical examination is performed to evaluate organ systems that could be impaired. This includes a search for evidence of liver failure, gastrointestinal bleeding, cardiac arrhythmia, and glucose or electrolyte imbalance. Hemorrhage from esophageal varices and hepatic encephalopathy require immediate treatment. Ascites mandates measures to control fluids and electrolytes, alcoholic hepatitis often is treated with glucocorticoids, and infection or sepsis is managed with antimicrobial agents. During this phase, the patient may refuse to accept the diagnosis and deny that a problem exists.⁵

The second step is withdrawal from alcohol, or in cases of severe dependence, reduction of alcohol consumption. Abrupt alcohol withdrawal results in loss of appetite, tachycardia, anxiety, insomnia, and delirium tremens (DTs)—characterized by shaking tremors, hallucinations, disorientation, impaired attention and memory, and extreme agitation. Physical findings include severe sweating, elevated blood pressure, and tachycardia. Management goals are to minimize the severity of withdrawal symptoms. Strict dietary modifications are required, including a high-protein, high-calorie, low-sodium diet and possibly fluid restriction. Patients should receive adequate nutrition and rest; oral multiple B vitamins, including 50 to 100 mg of thiamine daily for at least 1 to 2 weeks; and iron replacement and folic acid supplementation as needed to correct any anemia present.⁵

The third step is to manage the CNS depression resulting from rapid removal of the ethanol. Administration of a benzodiazepine, such as diazepam or chlordiazepoxide, in gradually decreasing doses to achieve downward titration of the serum drug levels over a 3- to 5-day period, alleviates alcohol withdrawal symptoms. The beta-blockers clonidine and carbamazepine are more recent additions to the pharmacotherapeutic management of withdrawal.⁵

After treatment of withdrawal has been completed, the patient is educated about alcoholism. This aspect of management includes teaching the family and friends to stop protecting the patient from the problems caused by alcohol. Attempts are made to help the patient with alcoholism achieve and maintain a high level of motivation toward abstinence. Steps also are taken to help the patient with alcoholism readjust to life without alcohol and to reestablish a functional lifestyle. The drug disulfiram has been used for some patients during alcohol rehabilitation. Disulfiram inhibits aldehyde dehydrogenase causing accumulation of acetaldehyde blood levels and thus sweating, nausea, vomiting, and diarrhea when taken with ethanol. Naltrexone (an opioid antagonist) and acamprosate (an inhibitor of the γ -aminobutyric acid

[GABA] system) may be used to decrease the amount of alcohol consumed or to shorten the period during which alcohol is used in cases of relapse.⁵

DENTAL MANAGEMENT

Medical Considerations (Box 30.1)

The dentist should be on the alert for signs and symptoms that may indicate substance abuse (see Table 30.2). Telltale cutaneous lesions often indicate parenteral abuse of drugs. Findings may include subcutaneous abscesses, cellulitis, thrombophlebitis, skin “tracks” (chronic inflammation from multiple injections), and infected lesions. Skin tracks usually appear as linear or bifurcated erythematous lesions, which become indurated and hyperpigmented. An ill-defined febrile illness also may indicate a possible problem with parenteral drug abuse.^{2,3,32}

Drug abusers may try to obtain drugs from dentists by demanding pain medication for a dental problem (e.g., toothache) instead of problem-specific treatment. Likewise, pain medication may be requested (or demanded) after minor, nonsurgical procedures that typically would not be a cause of significant postoperative pain (e.g., small restoration). The opioid abuser also may claim to be allergic to codeine or intolerant to nonsteroidal antiinflammatory drugs in an attempt to obtain a stronger drug such as hydrocodone or oxycodone. Prescription pads should not be left out in clear view, nor should they be kept where patients can easily find and take them. The practitioner also should avoid the use of prewritten or presigned prescription forms for controlled drugs. The patient with possible opioid overdose should be given a dose of Narcan nasal spray to reverse the symptoms.²⁴

Drug abuse is found more often in dentists and other dental office personnel than in the general population because of the ready access to opioid analgesics and sedative-hypnotic drugs. Abusive use of nitrous oxide inhalation is another form of drug abuse that is found among dentists.

Marijuana. Chronic use of marijuana can lead to chronic bronchitis, airway obstruction, poor oral health due to neglect and xerostomia, and squamous metaplasia. The autonomic effects of marijuana include tachycardia, reduced peripheral resistance, and, with large doses, orthostatic hypotension.³² Thus, marijuana use may be harmful to persons with ischemic heart disease or cardiac failure. Care should be taken in providing dental treatment to such patients, and if such an association is identified, dental treatment should be postponed until the patient is stable.

Cocaine. Patients who are “high” on cocaine should not receive any local anesthetic containing epinephrine for at least 6 hours after the last administration of cocaine because cocaine potentiates the response of sympathomimetic amines.¹⁶ Use of epinephrine-impregnated retraction cord or local anesthetics containing epinephrine or levonordefrin should be avoided. The danger of significant

BOX 30.1

Dental Management Considerations in Patients With Drug or Alcohol Abuse or Dependence

P

Patient Evaluation and Risk Assessment (see Box 1.1)

- Evaluate to determine whether drug or alcohol abuse or dependence is present.
- Obtain medical consultation if clinical signs and symptoms point to an undiagnosed problem or if the diagnosis is uncertain.

Potential Issues and Factors of Concern

A

Antibiotics	No issues
Analgesics	Avoid prescribing narcotic analgesics, if possible. However, if needed, consult with patient's primary care physician who is managing the substance abuse program. Prescribe an adequate-strength medication and only a limited number of doses with specific instructions, with no refills. It may be appropriate to have a third party (such as a "12-step program" sponsor) monitor and dispense the medication.
Anesthesia	For cocaine and methamphetamine abusers, avoid the use of epinephrine for 24 hours after the last dose of drug.
Allergies	No issues
Anxiety	If the patient requires an anxiolytic for treatment, contact the patient's physician to discuss options. Consider using a short-acting benzodiazepine and prescribe only enough for one appointment. Also consider intraoperative use of nitrous oxide–oxygen.

B

Bleeding	For patients with alcohol abuse, excessive bleeding secondary to liver disease is possible. Laboratory tests may be needed for confirmation.
----------	--

Breathing	No issues
Blood pressure	For cocaine and methamphetamine abusers, monitor blood pressure and pulse during appointment.

C

Chair position	No issues
Cardiovascular	Cocaine and methamphetamine abusers are at increased risk for cardiac arrhythmias, myocardial infarction, and stroke.

D

Drugs	Epinephrine can potentiate the adverse cardiovascular effects of cocaine and amphetamines.
-------	--

Devices	No issues
---------	-----------

E

Equipment	No issues
Emergencies	For cocaine and methamphetamine abusers, cardiovascular emergencies are possible, especially with the use of epinephrine within 24 hours of last drug use. Have naloxone (Narcan) available to reverse opioid overdose.

F

Follow-up	If narcotic analgesics are prescribed, the patient should be monitored to ensure proper drug use.
-----------	---

myocardial ischemia and cardiac arrhythmia is the primary concern in patients with cocaine intoxication. Peak blood levels of cocaine occur within 30 minutes, and effects usually dissipate within 2 hours.

Before treating a patient who is participating in a cocaine treatment program, the dentist should consult the patient's physician regarding medications that the patient may be taking and how best to manage procedure-related pain. Patients with substance abuse should rarely be prescribed addictive substances and then only with great caution.²

Methamphetamine. Patients who are "high" on methamphetamine should not receive dental treatment for at least 8 hours after the last administration of the drug, and for maximum safety, dental treatment probably should not occur until at least 24 hours after the last administration. Peak blood levels occur within 30 to 60 minutes, and effects usually dissipate within 8 hours; however,

depending on the compound, the serum half-life of the various amphetamines can last between 7 and 34 hours.^{2,33} Significant myocardial ischemia and cardiac arrhythmia are the primary concerns in patients with methamphetamine intoxication. Local anesthetics with epinephrine or levonordefrin must not be used during the 8-hour waiting period after methamphetamine administration because methamphetamine potentiates the response of sympathomimetic amines, which could result in a hypertensive crisis, stroke, or myocardial infarction.³⁴

Alcohol. The dentist has an opportunity to assist patients who have, or may have, alcohol-abuse problems. It has been shown that even brief advice or discussions in a clinical setting by a health care provider can have positive effects. Research indicates that brief interventions for alcohol problems are more effective than no intervention and, in some cases, can be as effective as more extensive intervention.^{35,36} On the basis of these findings,

the Center for Substance Abuse Treatment (CSAT) has devised a new initiative known as Screening, Brief Intervention, Referral, and Treatment (SBIRT), summarized next.

Screening. A patient with alcohol-related problems often can be recognized from examination of health problems and behaviors, such as medical signs and symptoms, noncompliance, exacerbated anxieties and fears, failure to fulfill obligations, and emotional fluctuations. Features suggestive of alcohol abuse include missed appointment, enlargement of the parotid glands (Fig. 30.5), and spider angiomas (Fig. 30.6). A common scenario that should raise a red flag is that in which the patient presents for treatment with alcohol on the breath. Of note, problems with alcohol transcend age, gender, and



FIG 30.5 Painless enlargement of the parotid glands associated with alcoholism. (Courtesy of Valerie Murrah, Chapel Hill, NC.)

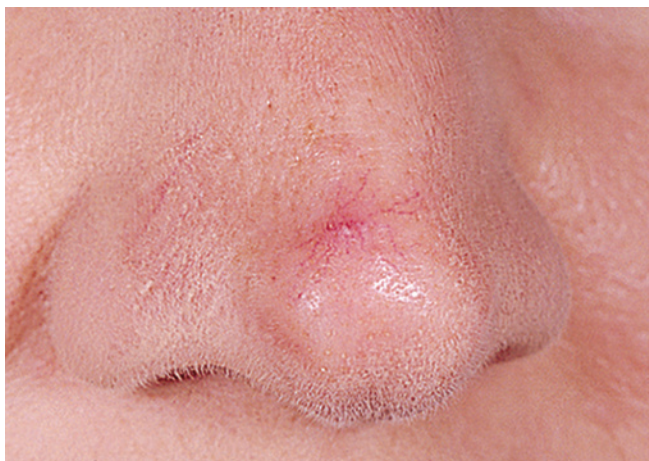

FIG 30.6 Spider angiomas, which may be a sign of alcoholism. (From Seidel HM, et al: *Mosby's guide to physical examination*, ed 6, St. Louis, 2006, Mosby.)

socioeconomic spectrum, and many patients are skilled at masquerading their dependence.

During the medical history, the dentist should obtain information from all adolescent and adult patients about the type, quantity, frequency, pattern of alcohol use, as well as consequences of its use, and family history of alcoholism. The National Institute on Alcohol Abuse and Alcoholism (NIAAA) has recommended either the use of a single alcohol screening question (SASQ) or administration of the Alcohol Use Disorders Identification Test (AUDIT) self-report questionnaire (Table 30.3) as the standard screening approach to detection of alcohol-related problems. An alternative screening approach is the use of the CAGE questionnaire, which only asks four questions that are designed to identify problem drinkers. The use of either the AUDIT or CAGE questionnaire is ideal but in most dental practices would be too time consuming and probably impractical, so the SASQ approach is a recommended alternative. When using the SASQ, clinicians are advised to ask if the patient has consumed five or more standard drinks (for a man) on one occasion during the past year (four drinks for women). The questioning should be done in an objective, nonjudgmental manner. A positive response may indicate an alcohol-related problem and requires more detailed assessment.¹⁶

Brief Intervention. It is important that the patient understand the adverse consequences of alcohol abuse in all aspects of the problem—medical, dental, psychological, and social. The dentist can point out destructive patterns of alcohol use and identify future health issues and other difficulties expected if alcohol abuse continues. Also important to review with the patient are the possibilities and successes of treatment. After a review of key ingredients in several brief intervention protocols, Miller and Sanchez³⁷ proposed six critical elements that they summarized with the acronym FRAMES: feedback, responsibility, advice, menu, empathy, and self-efficacy. The clinician completes some assessment and provides *feedback* on the patient's alcohol-related problems, stresses the patient's *responsibility* to address the problem, gives clear *advice* to change drinking behavior, provides a *menu* of treatment options, expresses *empathy* for the patient's problem, and stresses *self-efficacy* (the expectation that the patient has the skills and information needed to successfully resolve the drinking problems). Additional components of goal setting, follow-up, and timing also have been identified as important to the effectiveness of brief interventions.

Referral. Assisting a patient into a treatment program requires that the dentist share concerns obtained from the medical assessment. Accordingly, the dentist will need to be familiar with treatment options within the local community such as detoxification, inpatient programs, outpatient programs, halfway houses, and continuing care. Consultation with or referral to the patient's primary care provider (if the person has one) is advised.

Treatment. Treatment of nondependent but at-risk problem drinkers may be accomplished by counseling,

TABLE 30.3 Alcohol Use Disorders Identification Test (AUDIT) Self-Report Questionnaire*

Patient: Because alcohol use can affect your health and can interfere with certain medications and treatments, it is important that we ask some questions about your use of alcohol. Your answers will remain confidential so please be honest. Circle the choice that best describes your answer to each question.

Questions	0	1	2	3	4	Score
1. How often do you have a drink containing alcohol?	Never	Monthly or less	2 to 4 times a month	2 to 3 times a week	4 or more times a week	
2. How many drinks containing alcohol do you have on a typical day when you are drinking?	1 or 2	3 or 4	5 or 6	7 to 9	10 or more	
3. How often do you have five or more drinks on one occasion?	Never	Less than monthly	Monthly	Weekly	Daily or almost daily	
4. How often during the past year have you found that you were not able to stop drinking once you had started?	Never	Less than monthly	Monthly	Weekly	Daily or almost daily	
5. How often during the past year have you failed to do what was normally expected of you because of drinking?	Never	Less than monthly	Monthly	Weekly	Daily or almost daily	
6. How often during the past year have you needed a first drink in the morning to get yourself going after a heavy drinking session?	Never	Less than monthly	Monthly	Weekly	Daily or almost daily	
7. How often during the past year have you had a feeling of guilt or remorse after drinking?	Never	Less than monthly	Monthly	Weekly	Daily or almost daily	
8. How often during the past year have you been unable to remember what happened the night before because of your drinking?	Never	Less than monthly	Monthly	Weekly	Daily or almost daily	
9. Have you or has someone else been injured because of your drinking?	No		Yes, but not in the last year		Yes, during the last year	
10. Has a relative, friend, doctor, or other health care worker been concerned about your drinking or suggested you cut down?	No		Yes, but not in the last year		Yes, during the last year	
						Total:

*This self-report questionnaire is from the World Health Organization. To reflect standard drink sizes in the United States, the number of drinks in question 3 was changed from 6 to 5. A free AUDIT manual with guidelines for use in primary care is available online at <http://www.who.org>.

From Babor TF, et al: *AUDIT: the alcohol use disorders identification test: guidelines for use in primary health care*. Geneva: World Health Organization, 2001, WHO/MSD/MSB/01.6a.

motivational techniques, and setting drinking limits below at-risk limits (e.g., less than one drink per day for women and two drinks per day for men).⁴ Treatment of alcohol dependence can occur informally without professional assistance; however, chances of a successful outcome are greater with an organized program based on professional help. The first step is complete withdrawal and abstinence from alcohol. Most often, this step can be accomplished on an outpatient basis, although for more severe dependence, inpatient treatment may be necessary. The major goals of medical management of alcohol withdrawal are to minimize the severity of withdrawal-related symptoms, to prevent specific withdrawal-related complications such as seizures and delirium tremens, and to provide referral to relapse prevention treatment.⁴ Relapse prevention is

accomplished using psychotherapeutic techniques (motivational enhancement techniques, “12-step program” facilitation, cognitive-behavioral coping skills), self-help groups (e.g., Alcoholics Anonymous [AA]), and pharmacotherapy. Three drugs are currently approved for the treatment of alcohol dependence: disulfiram, naltrexone, and acamprosate.⁵

To minimize risk for relapse, the dentist should avoid the use of psychoactive drugs, narcotics, sedatives, and alcohol-containing medications in patients who are recovering from alcoholism. If a potentially mood-altering drug is required, the patient’s primary care physician (or substance abuse advisor) should be consulted about its use. If approved for use, the drug should be prescribed only in the amount needed without refills. Designating a

family member to fill and dispense the drug can minimize the risk of abuse.

Treatment Planning Considerations (see Box 30.1)

The goals of dental treatment for patients with substance and alcohol abuse disorders are to maintain oral health, comfort, and function and to prevent and control oral disease. Without an aggressive approach to prevention, dental caries and periodontal disease will occur with increased frequency. Susceptibility to these problems stems from a reduced interest in performing or the inability to perform oral hygiene procedures. Also, in many of these patients, the diet typically relies heavily on foods and drinks that increase the risk for dental disease.³⁸

The dental treatment plan should contain the following elements (see Box 30.1). Daily oral hygiene procedures must be identified. Complex dental procedures should be performed only when the patient is in a stable condition in the context of the substance abuse disorder. The dental team should communicate to the patient a positive, hopeful attitude toward maintenance of the patient's oral health. The last aspect of the treatment plan deals with selection of pain or anxiolytic medications to be used in dental treatment procedures. It is critical that appropriate pain and anxiolytic medication be provided to the patient; however, certain agents may have to be avoided, and others may require a reduction in their usual dosage. Consultation with the physician who is overseeing the management of the substance or alcohol abuse problem is advisable to discuss drug selection and administration. It also may be necessary to involve a third party, such as a "12-step program" sponsor, to monitor the taking of medication.³⁹

In addition to the above considerations, three specific problems of major clinical importance in patients with alcoholic liver disease are recognized: (1) bleeding tendencies, (2) unpredictable metabolism of certain drugs, and (3) risk for spread of infection. These conditions may require the dentist to change usual drug dosages. Chapter 10 presents specific management recommendations for these problems.

Oral Complications and Manifestations

Patients with drug and alcohol abuse disorders tend to have more plaque, calculus, caries, and gingival inflammation than is typical for patients without such disorders. These problems are related primarily to oral neglect rather than to any inherent property of the abused substance. Depending on the degree of neglect, caries, and periodontal disease, the dentist should not provide extensive care until the patient demonstrates an interest in and ability to care for the dentition. With intraoral use of cocaine, gingival recession and erosion of the facial aspects of the maxillary teeth may result from persistent rubbing of the powder over these surfaces. Chronic methamphetamine use causes xerostomia and rampant caries with subjective



FIG 30.7 "Meth mouth."

reports of a bad taste in the mouth, bruxism (grinding of the teeth), and muscle trismus (jaw clenching).³⁴ Xerostomia significantly increases the risks for dental caries, enamel erosion, and periodontal disease. Neglect of personal oral hygiene, high intake of refined carbohydrates and sucrose, and increased acidity from gastrointestinal regurgitation, bulimia, or vomiting also contribute to exaggerated caries and erosion problems in meth abusers. The combination of these effects is referred to as "meth mouth" (Fig. 30.7). Meth users are "wired" and exhibit extremely high levels of energy and neuromuscular activity, often leading to parafunctional jaw activity and bruxism. Bruxism and muscle trismus can compound the effects of periodontal disease. Patients who use ecstasy demonstrate "bruxing" activity during use of the drug. To combat the tooth clenching, pacifiers have been used.

A variety of oral abnormalities may be found in patients with alcohol abuse. Patients with cirrhosis have been reported to have impaired gustatory function and are malnourished. Nutritional deficiencies can result in glossitis and loss of tongue papillae along with angular or labial cheilitis, which is complicated by concomitant candidal infection. Vitamin K deficiency, disordered hemostasis, portal hypertension, and splenomegaly (causing thrombocytopenia) can result in spontaneous gingival bleeding, mucosal ecchymoses, and petechiae. In some instances, unexplained gingival bleeding has been the initial complaint of alcoholic patients. Also, a sweet, musty odor to the breath is associated with liver failure, as is jaundiced mucosal tissue. A bilateral, painless enlargement of the parotid glands (sialadenosis) (see Fig. 30.5) is a frequent finding in patients with cirrhosis.⁴⁰⁻⁴³

Alcohol abuse and tobacco use are strong risk factors for the development of oral squamous cell carcinoma, and dentists must be diligent (as with all patients) in the detection of unexplained or suspicious soft tissue lesions (especially leukoplakia, erythroplakia, or ulceration) or a firm neck lymph node in patients with chronic alcoholism. High-risk sites for development of oral squamous cell carcinoma include the lateral border of the tongue and the floor of the mouth (see Chapter 26).

REFERENCES

- American Psychiatric Association. *Diagnostic and Statistical Manual of Mental Disorders (DSM-IV-TR)*. 4th ed. Washington DC: American Psychiatric Association; 2000.
- Samet JH. Drug use and dependence. In: Goldman L, Ausiello D, eds. *Cecil Medicine*. 23rd ed. Philadelphia: Saunders; 2008:174-182.
- Hyman SE. Biology of addiction. In: Goldman L, Ausiello D, eds. *Cecil Medicine*. 23rd ed. Philadelphia: Saunders; 2008:159-161.
- Hyman SE, Kandel E. Biology of psychiatric disorders. In: Fauci AS, ed. *Harrison's Principles of Internal Medicine*. 17th ed. New York: McGraw-Hill; 2008:2705-2709.
- O'Conner PG. Alcohol abuse and dependence. In: Goldman L, Ausiello D, eds. *Cecil Medicine*. Philadelphia: Saunders Elsevier; 2008: 167-174.
- Van Skike CE, Maggio SE, Reynolds AR, et al. Critical needs in drug discovery for cessation of alcohol and nicotine polysubstance abuse. *Prog Neuropsychopharmacol Biol Psychiatry*. 2016;65:269-287.
- Puente D, Cabezas C, Rodriguez-Blanco T, et al. The role of gender in a smoking cessation intervention: a cluster randomized clinical trial. *BMC Public Health*. 2011;11:369.
- US Department of Health and Human Services, Office of Applied Studies. The NSDUH Report. Rockville, MD; 2009.
- Lipari RN, Kroutil LA, Pemberton MR. Risk and Protective Factors and Initiation of Substance Use: Results from 2014 National Survey on Drug Use and Health. 2015.
- Smart RG. Effects of legal restraint on the use of drugs: a review of empirical studies. *Bull Narc*. 1976;28(1):55-65.
- Pacula RL, Jacobson M, Maksabedian EJ. In the weeds: a baseline view of cannabis use among legalizing states and their neighbours. *Addiction*. 2016;111(6): 973-980.
- Peace MR, Stone JW, Poklis JL, et al. Analysis of a commercial marijuana e-cigarette formulation. *J Anal Toxicol*. 2016;40(5):374-378.
- Rogers JS, Rehrer SJ, Hoot NR. Acetylfentanyl: an emerging drug of abuse. *J Emerg Med*. 2016;50(3): 433-436.
- Alcoholism NIH. NIH, ed. *Alcohol Facts and Statistics*. Washington D.C.: NIH; 2016:6.
- Grant BF, Stinson FS, Dawson DA, et al. Prevalence and co-occurrence of substance use disorders and independent mood and anxiety disorders: results from the National Epidemiologic Survey on Alcohol and Related Conditions. *Arch Gen Psychiatry*. 2004;61(8):807-816.
- National Institute on Alcohol and Alcoholism. *Helping patients who drink too much: a clinician's guide and related professional support resources*. Rockville, MD: U.S. Department of Health and Human Services; 2005.
- Renner JA, Ward N. Drug addiction. In: Stern TA, ed. *Massachusetts General Hospital Comprehensive Clinical Psychiatry*. Philadelphia: Mosby Elsevier; 2008.
- Zawilska JB. "Legal highs" - an emerging epidemic of novel psychoactive substances. *Int Rev Neurobiol*. 2015;120:273-300.
- Weiss RD. *Drugs of Abuse*. Philadelphia, PA: Elsevier (Saunders); 2016.
- Wen H, Hockenberry JM, Cummings JR. The effect of medical marijuana laws on adolescent and adult use of marijuana, alcohol, and other substances. *J Health Econ*. 2015;42:64-80.
- Borodovsky JT, Crosier BS, Lee DC, et al. Smoking, vaping, eating: is legalization impacting the way people use cannabis? *Int J Drug Policy*. 2016.
- Cahill TJ, Prendergast BD. Infective endocarditis. *Lancet*. 2016;387(10021):882-893.
- Letter HMH. Painkillers fuel growth in drug addiction. Opioid overdoses now kill more people than cocaine or heroin. *Harv Ment Health Lett*. 2011;27(7):4-5.
- Leavitt SB. Intransal naloxone for at home opioid rescue practical pain management. 2010(October): 20-25.
- Kanouse AB, Compton P. The epidemic of prescription opioid abuse, the subsequent rising prevalence of heroin use, and the federal response. *J Pain Palliat Care Pharmacother*. 2015;29(2):102-114.
- Volkow ND, Fowler JS, Wang JS. The addicted brain: insights from imaging studies. *J Clin Invest*. 2003;111: 1444-1451.
- Katselou M, Papoutsis I, Nikolaou P, et al. Fenethylamine (Captagon) abuse. Local problems from an old drug become universal. *Basic Clin Pharmacol Toxicol*. 2016;119(2):133-140.
- Frauger E, Amaslidou D, Spadari M, et al. Patterns of methylphenidate use and assessment of its abuse among the general population and individuals with drug dependence. *Eur Addict Res*. 2016;22(3):119-126.
- Cho AK, Melega WP. Patterns of methamphetamine abuse and their consequences. *J Addict Dis*. 2002;21(1):21-34.
- US Department of Health and Human Services. US Department of Health and Human Services, ed. *Drug Abuse Warning Network, 2004: National Estimates of Drug-Related Emergency Department Visits*. Rockville, MD: Office of Applied Studies; 2004.
- Winstock A. Psychoactive drug misuse. In: Wright P, Stern J, Phelan M, eds. *Core Psychiatry*. 2nd ed. Edinburgh: Elsevier; 2005:431-455.
- Bockman CS, Abel PW. Drugs of abuse. In: Yagiella JA, et al, eds. *Pharmacology and Therapeutics for Dentistry*. St. Louis: Mosby Elsevier; 2011:799-813.
- Albertson TE, Kenyon NJ, Morrissey B. Amphetamines and derivatives. In: Shannon MW, Borron SW, Burns MJ, eds. *Haddad and Winchester's Clinical Management of Poisoning and Drug Overdose*. Philadelphia: Saunders Elsevier; 2007.
- Hamamoto DT, Rhodus NL. Methamphetamine abuse and dentistry. *Oral Dis*. 2009;15(1):27-37.
- Bien T, Miller WR, Tonigen JS. Brief interventions for alcohol problems: a review. *Addiction*. 1993;88(3): 315-336.

36. Fleming M. Brief interventions and the treatment of alcohol use disorders:current evidence. *Recent Dev Alcohol*. 2003;16:375-390.
37. Miller WR, Sanchez V. Motivating young adults for treatment and lifestyle change. In: Howard G, Nathan P, eds. *Alcohol Use and Misuse by Young Adults*. Notre Dame, IN: University of Notre Dame Press; 1994.
38. Little JW. Dental implications of mood disorders. *J Gen Dent*. 2004;52(5):442-450.
39. Lindroth JE, Herren MC, Falace DA. The management of acute dental pain in the recovering alcoholic. *Oral Surg Oral Med Oral Pathol Oral Radiol Endod*. 2003;95(4):432-436.
40. Bergasa NV. Approach to the patient with liver disease. In: Goldman L, Ausiello D, eds. *Cecil Medicine*. Philadelphia: Saunders Elsevier; 2008.
41. Brennan MT, Hong C, Furney SL, et al. Utility of an international normalized ratio testing device in a hospital-based dental practice. *J Am Dent Assoc*. 2008;139(6):697-703.
42. Friedman LS. Surgery in the patient with liver disease. *Trans Am Clin Climatol Assoc*. 2010;121:192-204.
43. McCullough AJ, O'Shea RS, Dasarathy S. Diagnosis and management of alcoholic liver disease. *J Dig Dis*. 2011;12(4):257-262.

Appendices

Guide to Management of Common Medical Emergencies in the Dental Office*

GENERAL CONSIDERATIONS

The best management of a dental office medical emergency is prevention. Dental practitioners must be prepared to treat the seemingly well but chronically ill patient whose condition is managed by a variety of drugs. Prevention begins with the dental professional's awareness of the patient's medical condition at the outset of the dental visit. Knowledge of the type of condition, its severity, and the level of control provides a strong indicator of the patient's risk for experiencing a medical emergency. Proper assessment that includes review of the medical history, physical evaluation, and medical consultation gives the practitioner the opportunity to take measures that could prevent such emergencies. If an emergency does occur, an informed dentist will have a better idea of the type of medical problem the patient is experiencing. The dentist must also understand the pathophysiologic factors regulating disease processes and the pharmacodynamics of drug action and interaction.

Patients frequently experience physical reactions during treatment. Accordingly, considerable responsibility rests on the dentist first to recognize the signs and symptoms of the problem and then to respond to any emergency quickly, efficiently, and competently with adequate resuscitative procedures. Obviously, important precepts of good medical emergency management include (1) being well prepared, (2) having confidence in selected interventions, and (3) remaining calm in difficult circumstances. Health professionals are responsible for knowing and using techniques that are recognized to be up to date, safe, and efficient. An unfamiliar or unreliable maneuver

should never be attempted. Dentists must be trained in providing basic cardiac life support (BCLS) and in managing emergencies in the dental office. Advanced cardiac life support (ACLS) training to include intravenous (IV) drug administration may be useful in dental practices that more often encounter medically complex cases. Dental practitioners also should be aware of the changes in basic cardiopulmonary resuscitation (CPR) guidelines introduced in 2010.

Although dentists should be prepared to provide resuscitation procedures in the dental setting, even more consideration should be directed at preventing such situations. Prevention begins with obtaining an adequate medical history of the patient, making an appropriate physical evaluation, and ensuring that both patient and environment are properly prepared before treatment begins. Sometimes a potentially catastrophic event may be prevented through recognition of physical conditions or limitations before treatment begins.

Management of emergencies must begin long before the point of occurrence. Preparation should include a designated plan of action and an adequate armamentarium to meet emergencies. To minimize largely unhelpful emotional responses, the actions of the dental team must be based on a thorough background in relevant subject matter, continued study, and carefully prepared and rehearsed emergency procedures in which each person has specific duties and responsibilities. This approach requires the availability of appropriate resuscitative equipment and drugs to permit the team to work together calmly and precisely. This teamwork must be based on knowledge, practice, sound judgment, and confidence. To this end, all members of the dental office (dentist, hygienist, assistant, receptionist) should be trained in and be able to perform BCLS procedures properly when needed. Also, every dental office should have a written plan that spells out specific duties for each member of the office staff, covering areas such as who will activate the emergency medical services (EMS) system (i.e., call 911), start CPR, place an IV line, and administer drugs. A staff member should be designated to assist in necessary tasks during the emergency situation, such as getting and preparing drugs and recording every event and the time of each action.

*Much of the material contained herein is modified from Malamed SF: *Medical emergencies in the dental office*, ed 6, St. Louis, 2007, Mosby; Malamed SF: *Emergency medicine in the dental office* (DVD), Edmonds, WA, Health First Corporation, 2008, Joseph Massad Productions; 2005 American Heart Association guidelines for cardiopulmonary resuscitation and emergency cardiovascular care, *Circulation* 112 (Suppl 24):IV1-203, 2005; and Part 1: executive summary: 2010 American Heart Association guidelines for cardiopulmonary resuscitation and emergency cardiovascular care, *Circulation* 122 (Suppl 3):S640-S656, 2010.

Dental offices should have up-to-date emergency drugs, oxygen, a pulse oximeter, and an automated external defibrillator (AED). Electrocardiography is an additional important adjunct modality for monitoring the patient's vital signs.

GENERAL PRINCIPLES OF EMERGENCY CARE

Most life-threatening office emergencies are caused by the patient's inability to withstand physical or emotional stress or the patient's reaction to drugs. Emergencies also can originate with a complication of a preexisting systemic disease. Cardiopulmonary systems can be involved, thereby necessitating some emergency supportive therapy.

Algorithms (i.e., standardized step-by-step procedures) are recommended to be performed during emergencies after the signs and symptoms of the condition are recognized. Most often, the algorithm for medical emergencies follows the sequence P-A-B-C-D, where P is for *positioning*, A is for *airway*, B is for *breathing*, C is for *circulation*, and D is for *definitive care* (e.g., diagnosis, drugs, and defibrillator and other equipment). Of note, however, in 2010, the American Heart Association recommended use of a slightly different algorithm for cardiac arrest, that is, P-C-A-B-D. Our own contribution has been to add an E, for *ensure proper patient response*, and an F, for *facilitate next steps in medical and dental care*, for a more specific approach to this aspect of dental management.

This appendix presents recommended management protocols, following the algorithms just described, for various medical emergencies likely to be encountered in dental offices.

KEY POINTS

The following elements are essential to the successful treatment of medical emergencies:

1. Quick recognition of signs and symptoms and early diagnosis of the underlying problem
2. Fast response time (4–6 minutes without oxygen leads to irreversible brain damage)
3. Systematic monitoring of the patient's well-being using an algorithm such as P-A-B-C-D-E-F or, for cardiac arrest, P-C-A-B-D-E-F

TYPES OF EMERGENCIES AND THEIR TREATMENT

UNCONSCIOUSNESS

Syncope and Psychogenic Shock

Signs and Symptoms. Pallor, sweating, nausea, anxiety, pupillary dilation, yawning, decreased blood pressure, bradycardia (slow pulse), convulsive movements, unconsciousness.

Cause. Cerebral hypoxia (reduced blood flow to brain), sitting or standing stiff, anxiety.

Treatment

- P: Positioning: Place patient in supine position; lower head slightly and elevate legs (for pregnant women, roll on left side)—assess consciousness.
- A: Airway: Ensure open airway.
- B: Breathing: Check breathing—should be adequate.
- C: Circulation: Check carotid pulse—should be adequate.
- D: Dispense or administer:
- Oxygen at flow rate of 5 to 6 L/min
 - Aromatic ammonia (e.g., Vaporole)—“smelling salts” (optional)
 - Cold compresses applied to forehead
- E: Ensure that vital signs, drug administration, and patient responses are properly monitored and recorded.
- F: Facilitate next steps in medical and dental care and reassure patient.

Low Blood Pressure or Slow Pulse

For low blood pressure or pulse (systolic is less than previous diastolic), the following protocol is indicated:

Treatment: Low Blood Pressure

- P: Positioning: Place patient in supine position; lower head and raise legs.
- A: Airway: Ensure open airway.
- B: Breathing: Check breathing—should be adequate.
- C: Circulation: Check pulse and ensure adequate circulation, which may be weak.
- D: Dispense or administer:
- Intravenous drip of 5% dextrose in lactated Ringer's solution (D5LR)
- In *unresponsive patient*: a vasopressor drug such as phenylephrine 10 mg/mL (1 ampule), or epinephrine 0.3 to 0.5 mg given subcutaneously (SC) or intramuscularly (IM), or IV with ACLS training
- E: Ensure that vital signs, drug administration, and patient responses are properly monitored and recorded.
- F: Facilitate next steps in medical and dental care; reassure patient.

Treatment: Slow Pulse (Less Than 60 beats/min)

- P: Positioning: Place patient in supine position; lower head and raise arms and legs.
- A: Airway: Ensure and maintain patent airway.
- B: Breathing: Check breathing—should be adequate.
- C: Circulation: Check—should be adequate in this situation.
- D: Dispense or administer:
- Oxygen at flow rate of 5 to 6 L/min (if patient is hypoxic)
 - Atropine 0.5 mg IV (to increase heart rate). Repeat dose up to 3 mg; then consider use of additional vasopressors (dopamine or epinephrine).
- E: Ensure that vital signs, drug administration, and patient responses are properly monitored and recorded.
- F: Facilitate next steps in medical and dental care; reassure patient.

Cardiac Arrest

Signs and Symptoms. No pulse or blood pressure, sudden cessation of respiration (apnea), cyanosis, dilated pupils.

Cause. Abrupt interruption of blood supply and oxygen to the coronary arteries and heart muscle due to ischemia (clot).

Treatment

For *unresponsive cardiac arrest victim* (adult):

P: Positioning: Place patient in supine position and establish unresponsiveness (tap and shout). Call for help, activate EMS (call 911), and get defibrillator.

C: Circulation and compressions: Health care provider should assess pulse (carotid) for no more than 10 seconds. If no pulse is detected and victim is not breathing and is unresponsive, promptly initiate chest compressions.

One operator: a rate of 100-120 compressions/min (depth of 2 inches)

A: Airway: Establish airway by head tilt–chin lift or by jaw thrust if neck injury is suspected. *Suction mouth and pharynx if vomitus is blocking the airway.*

B: Breathing:

If rescuer is ACLS-trained, perform endotracheal intubation and provide positive-pressure oxygen.

NOTE: As of 2015: Ventilation is no longer recommended in BLS; only the cardiac compressions are performed for a rate of 100-120 compressions/min. Continue compressions until spontaneous pulse returns.

NOTE: The importance of technique for chest compressions cannot be overemphasized; they must be hard, fast, and maximally effective, with minimal interruptions.

D: Defibrillator: Attach and use AED as soon as available (ideally within 3–5 minutes of collapse).

- Check rhythm and shock if indicated (repeated every 2 minutes).
- Resume CPR beginning with compressions immediately after each shock.

NOTE: With IV drugs: Start normal saline solution (with ACLS-trained rescuer).

- Epinephrine 1.0 mg 1:1000; repeat every 3 to 5 minutes as needed.
- Vasopressin 40 units can replace first or second dose of epinephrine.
- Amiodarone—*first dose:* 300 mg bolus; *second dose:* 150 mg

Other drugs used for treatment of cardiac arrest (with ACLS-trained rescuer)

- Lidocaine (antiarrhythmic agent)
- Calcium chloride (increases myocardial contractility)
- Morphine sulfate (for pain relief)
- Thrombolytic agents

E: Ensure that vital signs, drug administration, and patient responses are properly monitored and recorded.

F: Facilitate or ensure next steps in medical care (transport to hospital); reassure patient.

Hypoglycemia (Insulin Shock)

Signs and Symptoms. Hunger, weakness, trembling, tachycardia, pallor, sweating, paresthesias, uncooperative, mental confusion (headache), incoherent, uncooperative, belligerent, unconscious, tonic-clonic movements, hypotension, hypothermia, rapid thready pulse, coma.

Cause. Lack of blood glucose to the brain; taking insulin and not eating.

Treatment

P: Position:

In *conscious patient:* place in upright sitting position.

In *unconscious patient:* place in supine position.

A: Airway: Ensure open airway.

B: Breathing: Ensure that patient is breathing.

C: Circulation: Check pulse and confirm adequate circulation; pulse could be weak.

D: Dispense:

In *conscious patient:* Give a drink with high sugar content such as orange juice or a glucose paste (cake icing) applied to the buccal mucosa.

In *unconscious patient:* Activate EMS by calling 911; then administer:

- Oxygen at flow rate of 5 to 6 L/min
- D5LR IV: Run the IV drip as fast as possible.
- Alternatively, give glucagon 1 mg SC or IM (or IV) or epinephrine (for transient relief).

E: Ensure that vital signs, drug administration, and patient responses are properly monitored and recorded.

F: Facilitate or ensure next steps in medical care (transport to hospital if some improvement is not fairly rapid). When patient regains consciousness, provide reassurance and information about what happened because the person is likely to have little memory of the incident.

Acute Adrenal Insufficiency

Signs and Symptoms. Altered consciousness, wet, clammy, confusion, weakness, fatigue, headache, pain in abdomen or legs, nausea and vomiting, hypotension and syncope, coma.

Cause. Adrenal suppression (low adrenocorticotropic hormone) by exogenous steroids. The patient may be medicated with steroids for many medical problems, or the cause may be primary or secondary malfunction of the adrenal cortex.

Treatment

P: Positioning: Place patient in semireclined position and raise feet slightly; call for help.

A: Airway: Ensure open airway.

B: Breathing: Should be adequate (i.e., predicted to be adequate in this situation).

C: Circulation: Check pulse and confirm adequate circulation.

D: Dispense:

In *conscious patient*:

- Provide oxygen at flow rate of 5 to 6 L/min.
- Give hydrocortisone 100 mg or dexamethasone 4 mg (IV).

In *unconscious patient*:

- Place in supine position.
- Activate EMS by calling 911.
- Administer oxygen at flow rate of 5 to 6 L/min.
- Confirm diagnosis from review of medical history, signs, and symptoms.
- Then start IV administration of D5LR and run the IV drip as fast as possible.
- Also provide hydrocortisone 100 mg or dexamethasone 4 mg (IV).
- Give a vasopressor drug (e.g., epinephrine 1:1000, 0.5 mL).

E: Ensure that vital signs, drug administration, and patient responses are properly monitored and recorded.

F: Facilitate or ensure next steps in medical care (transport to hospital); reassure patient.

Cerebrovascular Accident (Stroke)

Signs and Symptoms. Dizziness (patient may fall), vertigo and vision changes, nausea and vomiting, transient paresthesia, unilateral weakness or paralysis, headache, nausea, vomiting, convulsions, coma.

NOTE: Blood pressure and pulse generally are normal. Raised blood pressure and body temperature and lowered pulse and respiration indicate increased intracranial pressure.

Cause. Interruption of blood supply and oxygen to the brain occurring as a result of ischemia or hemorrhage.

Treatment

P: Positioning: Place patient in reclined, semisitting position with the head elevated. Call for help and activate EMS (call 911).

A: Airway: Ensure that airway is open and maintained open.

B: Breathing: Ensure that breathing is adequate.

C: Circulation: Check pulse and confirm adequate circulation.

D: Dispense or administer:

- Use pulse oximeter to determine oxygenation.
- Administer oxygen at flow rate of 5 to 6 L/min if needed.

E: Ensure that vital signs, drug administration, and patient responses are properly monitored and recorded.

- Keep patient quiet and still.

F: Facilitate or ensure next steps in medical care (transport to hospital); reassure patients.

Convulsions (Seizure)

Signs and Symptoms. Aura (flash of light or sound, an unusual smell), mental confusion, excessive salivation, rolling back of eyes, loss of consciousness, tonic phase (contractions—clenching of teeth) followed by clonic phase (tremors, convulsive movements of extremities).

Causes. There are several potential causes of convulsions and seizures, including syncope, drug reactions (local anesthetic overdose), hypoglycemia, hyperventilation, cerebrovascular accident, and convulsive seizure disorder.

Treatment

P: Positioning: Place patient in supine position; clear instruments and protect patient from injury (i.e., lightly restrain arms and legs from gross movements). Call for help.

After convulsion ceases:

A: Airway: Ensure that airway is open. Suction mouth along buccal surfaces of teeth if excessive secretions are making breathing difficult.

B: Breathing: Ensure that breathing is adequate.

C: Circulation: Check pulse and confirm adequate circulation.

D: Dispense or administer:

- Oxygen at flow of 5 to 6 L/min

For status epilepticus (a seizure lasting more than 5 minutes):

- Activate EMS (call 911).
- For adult, give diazepam (Valium) 5 to 20 mg IV or intranasal lorazepam 2 to 4 mg or intranasal midazolam 5 mg, one-half volume per nostril (may not be readily available; ask pharmacist)

If convulsions persist for 5 minutes after treating, repeat with one-half dose.

E: Ensure that vital signs, drug administration, and patient responses are properly monitored and recorded.

- Support respiration (seizure may precipitate respiratory arrest).

F: Facilitate or ensure next steps in medical care (transport to hospital, if needed), and reassure patient.

Local Anesthesia Drug Toxicity

Signs and Symptoms. Confusion, talkative, restless, apprehensive state, excited manner, headache, lightheadedness, convulsions, increase in blood pressure and pulse rate. NOTE: Stimulation is followed by depression of the central nervous system.

Late features may include drowsiness, disorientation, convulsions followed by depression, drop in blood pressure, weak or rapid pulse or bradycardia, apnea, unconsciousness, or death. NOTE: Lidocaine toxicity is documented to occasionally exhibit depression only, without the usual prodromal of the excitatory phase.

Causes. Too large a dose of local anesthetic per body weight, rapid absorption of drug or inadvertent IV injection, slow detoxification or elimination of drug

Treatment

P: Positioning: Place patient in comfortable position; convulsing or unconscious patient should be in supine position.

If patient is convulsing:

- Clear instruments and protect patient from injury.
- Call for help.

After convulsion ceases:

- A: Airway: ensure airway is open.
 B: Breathing: Ensure that breathing is adequate.
 C: Circulation: Check pulse and confirm adequate circulation.
 D: Dispense or administer:
 - Oxygen at flow rate of 5 to 6 L/min
 - If local anesthesia overdose results in seizure, a benzodiazepine (diazepam, lorazepam, or midazolam) as described in the seizure algorithm may be administered.
 E: Ensure vital signs and drug administration are properly monitored and recorded; maintain blood pressure.
 F: Facilitate or ensure next steps in medical care (provide supportive therapy):
 - Treat bradycardia (0.4 mg of atropine IV, with ACLS-trained rescuer).
 - Transport to hospital.
 - Reassure patient.

NOTE: If patient becomes unconscious, maintain airway, administer CPR, and activate EMS (call 911).

RESPIRATORY DIFFICULTY

Hyperventilation

Signs and Symptoms. Rapid and shallow breathing, confusion, dizziness, paresthesias, cold hands, carpal-pedal spasms; can progress to seizure.

Cause. Anxiety-induced excessive loss of CO₂ from deep and rapid breathing; also respiratory alkalosis.

Treatment

- P: Positioning: Place patient in an upright position. Explain the problem and reassure the patient.
 A: Airway: Maintain open airway by talking with patient.
 B: Breathing: Instruct patient to be calm and breathe slowly into a paper bag or into the cupped hands over the nose and mouth (i.e., rebreathe carbon dioxide).
 C: Circulation: No treatment required.
 D: Dispense (i.e., provide) reassurance.
 E: Ensure that vital signs, drug administration, and patient responses are properly monitored and recorded.
 F: Facilitate or ensure next steps in medical and dental care: Consider rescheduling appointment with anti-anxiety measures or premedication.

Aspiration or Swallowing a Foreign Object

Signs and Symptoms. Coughing or gagging associated with a foreign object, inability to speak, possible cyanosis from airway obstruction, violent respiratory effort, suprasternal retraction, rapid pulse.

Cause. Foreign body in larynx or pharynx.

Treatment

With conscious victim:

- P: Positioning: Keep the patient standing or sitting leaning forward. Ask: “Can you speak?” or “Are you choking?” Patient may indicate need for help by demonstrating the “universal choking sign”—clutching hands wrapping around the neck or nodding.
 A: Airway: Open airway by placing arms around patient and applying Heimlich maneuver.
 B: Breathing: Repeat maneuver until object is cleared and breathing is reestablished, or until patient becomes unconscious.

With unconscious or unresponsive victim:

- P: Positioning: Place victim in supine position. Activate EMS (call 911); then initiate CPR in C-A-B sequence.
 C: Circulation: Check pulse; begin CPR if no pulse is felt. Provide chest compressions in ratio of 30 per 2 ventilations. (NOTE: Chest compressions provide pressure to dislodge foreign object.)
 A: Airway: Open airway by administering quick upward abdomen thrusts (up to 5).
 B: Breathing: Check airway for breathing and attempt to ventilate. Each time the airway is opened, the rescuer should look for an object in the victim’s mouth and remove it if found.
 - Do not delay the 30 chest compressions for longer than 10 seconds while looking for object.
 - Continue chest compressions and ventilation attempts until EMS unit arrives.

NOTE: If cricothyrotomy is necessary (i.e., rescuer is unable to ventilate for 4–5 minutes), refer to “Cricothyroid Membrane Puncture” procedure that follows.

After breathing has been reestablished:

- D: Dispense or administer:
 - Oxygen at flow rate of 5 to 6 L/min
 E: Ensure that vital signs, drug administration, and patient responses are properly monitored and recorded.
 F: Facilitate or ensure next steps in medical care (maintain supine position and transport to hospital); reassure patient.
 - Inform patient and request radiographs to locate foreign object or trauma to chest cavity is suspected, if needed (posterior-anterior chest view, lateral chest view, flat plane abdominal).

NOTE: If foreign object is in gastrointestinal tract, track with x-ray examination. Foreign object in trachea or lung requires removal using bronchoscopy or thoracotomy. If foreign object has occluded the airway, the Heimlich maneuver may be of benefit before initiation of a cricothyrotomy.

Cricothyroid Membrane Puncture

The approach to a patient with acute airway obstruction should consist of the following steps:

- Recognition of obstruction
- Use of nonsurgical maneuvers to relieve obstruction (i.e., back blows, Heimlich maneuver).
- Administration of mouth-to-mouth breathing to bypass obstruction or to diagnose obstruction
- Activation of EMS with 911 call
- Establishment of an emergency surgical airway (cricothyrotomy) if Heimlich maneuver is unsuccessful

Cricothyrotomy

1. Place patient in head-down position with neck hyperextended.
2. Ensure that chin and sternal notch are held in median plane.
3. Cut skin or puncture with very-large-bore needle over cricothyroid cartilage.
4. Insert cricothyrotomy cannula (Portex Mini-Trach II) or very-large-bore needle through skin over cricothyroid cartilage. Insert pointed end caudally to avoid damage to the vocal cords.

If cannula is not available:

- a. Insert small scissors or hemostats through cricothyroid membrane and into the tracheal space, or use large (8-gauge) needle.
 - b. Expand instrument and dilate transversely.
 - c. Insert tube into trachea between beaks of dilating instrument.
 - d. Remove scissors or hemostats.
 - e. Tape tube into place.
5. Use positive pressure or enriched oxygen flow if patient is breathing independently.
 6. Arrange for rapid transfer of patient to the hospital.

Bronchial Asthma

Signs and Symptoms. Sense of suffocation, pressure in chest, nonproductive cough, expiratory wheezes, prolonged expiratory phase, increased respiratory effort, chest distention, thick, stringy mucous sputum, cyanosis (in severe cases).

Causes. Can be induced by allergy, infection, exercise, anxiety leading to bronchial inflammation, bronchoconstriction, vascular permeability, occlusion of bronchioles by thick mucous plugs, and bronchospasm.

Treatment

- P: Positioning: Place patient in an upright comfortable position.
- A: Airway: Ensure that airway is open by removing dental materials and listening to breath sounds.
- B: Breathing: Encourage relaxed slow breathing.
- C: Circulation and communication: generally, circulation is adequate if patient is conscious. Communicate with patient and staff to get a rapid bronchodilator for use. Calm the patient and the staff.
- D: Dispense or administer:
- Two deep inhalations of fast-acting, β_2 -agonist bronchodilator (e.g., albuterol, Isuprel mistometer)

- Repeat with two additional deep inhalations of bronchodilator if attack persists 5 minutes.
 - Oxygen at flow rate of 5 to 6 L/min, if needed
- E: Ensure that vital signs are properly monitored and recorded.
- If attack persists, activate EMS (call 911).
- F: Facilitate next steps in medical care (transport to hospital); reassure patient.
- Maintain oxygen at flow rate of 5 to 6 L/min.
 - With *unresponsive patient*: administer epinephrine 1: 1000 (0.3–0.5 mL SC); repeat every 20 minutes as needed.

If transport to hospital is pending:

- Give theophylline ethylenediamine (aminophylline) 250 to 500 mg IV slowly over a 10-minute period.
- Administer hydrocortisone sodium succinate (Solu-Cortef), 100 mg IV.

NOTE: Because aminophylline may cause hypotension, it should be given with extreme caution to patients with asthma who are hypotensive.

Mild (Delayed Onset) Allergic Reaction

Signs and Symptoms. Mild pruritus (itching)—slow appearance; and mild urticaria (rash)—slow appearance.

Cause. Overreaction to allergens such as drugs, pollens, or food in which mast cells degranulate and release histamine, often in skin or mucosa.

Treatment

- P: Positioning: Place patient in comfortable position (upright).
- A: Airway: Ensure that airway is open by talking with patient.
- B: Breathing: Ensure that breathing is adequate.
- C: Circulation and communication: Should be adequate in this situation. Request blood pressure cuff. There should be no tachycardia, hypotension, dizziness, dyspnea, or wheezing. Inform the patient that an antihistamine drug will be administered.
- D: Dispense or administer:
- Diphenhydramine (Benadryl) 25 to 50 mg orally (PO) or IM (or IV if dentist has ACLS or advanced training).
 - Repeat dose up to 50 mg every 6 hours PO for 2 days if needed.
- E: Ensure that vital signs, drug administration, and patient responses are properly monitored and recorded.
- F: Facilitate or ensure next steps in medical care.
- In this case, allergy testing should be considered, and dentist should initiate discussion with physician to withdraw offending drug.

Severe (Immediate Onset) Allergic Reaction

Signs and Symptoms. Skin reactions—rapid appearance such as severe pruritus (itching of skin, throat, palate);

severe urticaria (rash); swelling of lips, eyelids, cheeks, pharynx, and larynx (angioneurotic edema); and anaphylactic shock (cardiovascular—fall in blood pressure; respiratory—wheezing, choking, cyanosis, hoarseness; central nervous system—loss of consciousness, dilation of pupils).

Cause. Overreaction to allergens such as drugs, pollens, and food where mast cells degranulate and release histamine in cardiopulmonary system.

Treatment

P: Positioning

With conscious patient: place in upright (most comfortable) position.

With unconscious patient: place in supine position and activate EMS (call 911).

A: Airway: Assess to ensure that airway is open.

B: Breathing: Ensure breathing is adequate by talking to and reassuring patient.

C: Circulation: No immediate requirement. Apply blood pressure cuff (pulse oximeter) to assess circulation within 5 minutes.

D: Dispense or administer:

- Epinephrine 0.3 to 0.5 mg 1: 1000 SC, IM, or IV if dentist has ACLS training
- Oxygen maintained at flow rate of 5 to 6 L/min
- Repeat epinephrine 0.3 to 0.5 mg 1: 000 SC or IM every 5 to 10 minutes as needed.

E: Ensure that vital signs, drug administration, and patient responses are properly monitored and recorded. NOTE: *Monitor blood pressure to ensure hypertension is not occurring.*

F: Facilitate or ensure next steps in medical care (transport to hospital); reassure patient.

If transport to hospital is pending:

- Give repeat doses of epinephrine 0.3 to 0.5 mg 1: 1000 SC or IM every 5 to 10 minutes as needed.
- Also administer 25 to 50 mg diphenhydramine (Benadryl) when patient's life is no longer in danger.

If dentist has ACLS training and laryngeal edema is involved:

- Provide steroids—hydrocortisone sodium succinate (Solu-Cortef), 100 mg SC, IM, IV
- Perform CPR if patient stops breathing and has no pulse, including use of AED.
- Perform cricothyrotomy if needed.

NOTE: Aminophylline may cause hypotension and should be used with extreme caution in patients with asthma who also are hypertensive.

Respiratory Arrest

Signs and Symptoms. Cessation of breathing, cyanosis.

Cause. Physical obstruction of airway (tongue or foreign object), drug-induced apnea.

Treatment

P: Positioning: Place patient in supine position and activate EMS (call 911).

A: Airway: Maintain open airway, tilting the patient's head back as indicated.

B: Breathing: Respirations will be absent.

- Open mouth to see if foreign object is readily accessible; remove object if visible (in adult).
- If foreign object cannot be removed, perform Heimlich maneuver (abdominal thrusts) until object is removed or no pulse is detected. If no pulse is felt, initiate CPR (using the C-A-B sequence) and chest compressions in a ratio of 30 per 2 ventilations.
- When the airway is open, ventilate patient 12 to 15 times per minute.

C: Circulation: Support blood pressure through position of patient, parenteral fluids, and vasopressors.

D: Dispense or administer appropriate drug:

- Give oxygen or artificial respiration.

If apnea is secondary to sedative or benzodiazepine (e.g., diazepam) overdose: administer reversal agent:

- Flumazenil (0.2 mg IV over 15 sec) if diazepam was used to sedate (with ACLS-trained rescuer); repeat 0.2 mg every minute up to 1 mg.

If apnea is secondary to narcotic or opioid overdose: administer reversal agent:

- 0.4 mg naloxone hydrochloride (Narcan) IV, IM, or SC plus oxygen
- Keep patient awake.

E: Ensure that vital signs, drug administration, and patient responses are properly monitored and recorded.

F: Facilitate or ensure next steps in medical and dental care (transport to hospital, if necessary); reassure patient.

NOTE: Monitor patient carefully for the duration of action of reversal agent (e.g., naloxone), which may be less than that of the narcotic. No reversal agent exists for barbiturate overdose.

Chest Pain

Angina Pectoris

Signs and Symptoms. Substernal myocardial pain that can radiate to arms, neck, jaw, or abdomen; myocardial pain lasting less than 15 minutes and possibly radiating to the left shoulder; pain relieved by nitroglycerin; patient usually has a history of the condition.

NOTE: Vital signs are normal; no hypotension, sweating, or nausea occurs.

Cause. Blood supply to the cardiac muscle is insufficient for oxygen demand (atherosclerosis or coronary artery spasm). Angina episode may be precipitated by stress, anxiety, or physical activity.

Treatment

P: Positioning: Place patient in sitting-up or semi-sitting-up (comfortable) position with head elevated.

- A: Airway: Ensure open airway.
 B: Breathing: Ensure that breathing is adequate.
 C: Circulation and communication: Check pulse and communicate with patient and staff to get nitroglycerin.
 D: Dispense or administer:
- Nitroglycerin 0.4-mg tablet sublingually or one or two metered spray doses (0.3–0.6 mg) of nitroglycerin sublingually
 - Repeat 1 nitroglycerin tablet every 5 minutes up to a total of 3 tablets or 3 sprays in 15-minute period.
 - Oxygen at flow rate of 5 to 6 L/min
 - If pain is not relieved with 3 doses of nitroglycerin, give one aspirin 325 mg and call 911.
- E: Ensure that vital signs, drug administration, and patient responses are properly monitored and recorded.
 F: Facilitate next steps in medical care (transport to hospital if needed); reassure patient.

NOTE: If any doubt exists about whether angina or myocardial infarction exists (i.e., pain continues, worsens, or subsides but then returns), activate EMS (call 911) or transport patient to hospital. After the nitroglycerin tablet container has been opened, the remaining tablets have a poor shelf life (30 days); a new supply should be stocked.

Myocardial Infarction

Signs and Symptoms. Development of chest pain, sometimes manifested as a crushing, squeezing, or heavy feeling, that is more severe than with angina, possibly radiating to the neck, shoulder, or jaw; lasting longer than 15 minutes; and not relieved by nitroglycerin tablets, in a conscious patient. Cyanotic, pale, or ashen appearance; weakness, cold sweat, nausea, vomiting, air hunger and sense of impending death; increased, irregular pulse beat of poor quality with palpitations, feeling of impending doom.

Cause. Interruption of blood supply to the heart, most commonly caused by occlusion of coronary vessels. Anoxia, ischemia, and infarct are present.

Treatment

For adult victim who is conscious and responsive:

- P: Positioning: Place patient in a comfortable position. Call for help and activate EMS (call 911).
 A: Airway: Ensure open airway.
 B: Breathing: Ensure that breathing is adequate by communicating with and reassuring patient.
 C: Circulation: Request equipment to check pulse and blood pressure.
 D: Dispense or administer:
- Aspirin 325-mg tablet in conscious patient
 - Oxygen at flow rate of 5 to 6 L/min
- E: Ensure that vital signs, drug administration, and patient responses are properly monitored and recorded.
 F: Facilitate or ensure next steps in medical and dental care (transport to hospital); reassure patient.

NOTE: Maintain patient in most comfortable position; this may not be the supine position because the air hunger may be associated with orthopnea.

- Administer nitrous oxide–oxygen (N₂O 30%, O₂ 70%), if available.
- Alternatively, Demerol (50 mg IV) or morphine (10 mg IV) may be administered if the dentist has ACLS training.

The condition may progress to cardiac arrest.

With *unresponsive patient*: Initiate CPR, including use of AED.

OTHER REACTIONS

Intraarterial Injection of Drug Into the Arm

Signs and Symptoms. Pain and burning sensation distal to the injection site; cold and blanching skin on hand or fingers distal to the injection site.

Cause. Intraarterial injection of drug into the arm.

Treatment

- P: Positioning: Place patient in supine position.
 A: Airway: Administer oxygen at flow rate of 5 to 6 L/min.
 B: Breathing: Ask patient to breathe slowly.
 C: Circulation and communication: Leave needle in place and communicate next steps to patient.
 D: Dispense:
- 40 to 60 mg of 2% lidocaine (2–3 mL)
 - 100 mg hydrocortisone sodium succinate (Solu-Cortef) IM
- E: Ensure that vital signs (obtained on other arm), drug administration, and patient responses are properly monitored and recorded.
 F: Facilitate or ensure next steps in medical care (transport to hospital), which may include heparinization and brachial plexus block.

Extrapyramidal Reactions

Antipsychotic Drugs Producing Side Reactions. Phenothiazines (Compazine, Thorazine, Phenergan, Sparine, Stelazine, Trilafon, Mellaril); butyrophenones (Haldol, Innovar [general anesthetic]); thioxanthenes (Navane, Taractan).

Signs and Symptoms. Acute dystonic reaction (more frequent in young people and women): rapid onset, involuntary movement of tongue, muscles of mastication, and muscles of facial expression; neck muscles affected frequently (torticollis), arms and legs affected less frequently; akathisia (constant motion); parkinsonism, tardive dyskinesia (involving buccolinguomasticatory triad—sucking, smacking, chewing, fly-catching movements of tongue).

Cause. Adverse effects of drug.

Treatment

- P: Positioning: Place patient in semiupright position.
 A: Airway: Ensure open airway.
 B: Breathing: Ensure that breathing is adequate by talking with and reassuring patient.

C: Circulation: Request blood pressure equipment or pulse oximeter to check circulation.

D: Dispense or administer:

- Diphenhydramine HCl (Benadryl) 25 to 50 mg PO or IV if dentist has ACLS training
- Oxygen at flow rate of 5 to 6 L/min

E: Ensure that vital signs, drug administration, and patient responses are properly monitored and recorded.

F: Facilitate or ensure next steps in medical care (transport to hospital); reassure patient.

Response to Unknown Cause

When a likely cause for the patient's response cannot be identified, a period of observation is justified.

P: Positioning: Place patient in supine position and activate EMS (call 911).

A: Airway: Ensure open airway, support respiration, and administer oxygen.

B: Breathing: Ensure that breathing is adequate.

C: Circulation: Request blood pressure equipment or pulse oximeter to check blood pressure and circulation.

D: Dispense or administer IV D5LR.

E: Ensure that vital signs, drug administration, and patient responses are properly monitored and recorded.

F: Facilitate or ensure next steps in medical and dental care:

- Keep patient off all medication.
- Reassure patient.
- Transfer to hospital if patient's condition is serious.
- Be prepared to do CPR and use the AED if needed.

Emergency Kit

Review contents, expiration date, and appearance of all drugs periodically (at least monthly). Ensure that kit contains the following:

1. Oxygen tank and setup
2. Blood pressure cuff
3. Stethoscope
4. Syringes (1, 5, 10, and 20 mL)
5. Lacrimal pocket mask
6. Disposable airway, nos. 2, 3, and 4
7. Butterfly needles, no. 3, 21 gauge
8. 22-gauge needles
9. IV tubing set, long no. 880-35
10. 250 mL dextrose, lactated Ringer's solution
11. Paper tape roll
12. Alcohol sponges
13. Drugs
 - Atropine: 0.5 mg/1-mL ampule
 - Aspirin: 325-mg tablets
 - Benadryl (diphenhydramine): 50-mg tablets or 50 mg/1 mL syringe/22 gauge, 1-inch needle
 - Aminophylline (theophylline ethylenediamine): 250 mg/1 mL syringe/22 gauge, 1-inch needle

Hydrocortisone sodium succinate (Solu-Cortef): 100 mg/2 mL syringe/22 gauge, 1-inch needle

Epinephrine 1: 1000

- Twinject: two doses of 0.3 mg
- EpiPen: auto-injector 0.3 mg
- 1.0-mL ampules

Glucagon: 1 mg/mL ampule

Naloxone hydrochloride (Narcan): 0.4 mg/1-mL ampule/tuberculin syringe

Nitroglycerin: 0.4-mg tabs (packed as 30/bottle) or pump spray (400 µg/spray)

Phenylephrine: 10 mg/mL (two or three 1-mL ampules)

Two ammonia inhalant buds (Vaporole)

Orange juice, glucose paste, or dextrose 50%: 100 mL

Diazepam (Valium): 5 mg/mL (Alternatively, stock lorazepam 2 mg/mL or midazolam 1 mg/mL)

Lidocaine 2%, 2-mL ampules

14. Curved cricothyrotomy cannula

15. Padded tongue blade

16. Pulse oximeter/ECG unit (medical resources)

17. AED (e.g., Heartstream FR-2, Medtronic Physio-Control, Survivalink)

NOTE: Commercial medical emergency kits for dentistry are available from companies such as Banyan International (Abilene, TX), Dixie Medical Inc. (Franklin, TN), and Health First (Mountlake Terrace, WA).

Pediatric Drug Doses

Pediatric doses are presented on a weight basis, which can be simply multiplied based on the patient's weight. Although nomograms using weight, surface area, and other factors may be more accurate, use of the following method is suggested in an emergency situation.

1. Diphenhydramine HCl (Benadryl): 1 to 1.25 mg/kg, up to 50 mg maximum IV; then 1 to 1.25 mg/kg q6h PO or parenterally
2. Atropine sulfate: 0.01 mg/kg, up to 0.4 mg maximum, IV or SC
3. Theophylline ethylenediamine (aminophylline): 3 to 5 mg/kg IV slowly—20 mg/min maximum
4. Epinephrine (adrenaline) 1: 1000
0.05 mg to 0.3 mg maximum SC or IM (diluted to 1:10,000 for IV administration)
EpiPen Junior—autoinjector 0.15 mg
5. Ammonia inhalants (e.g., Vaporole): Same as for adults
6. Hydrocortisone sodium succinate: Adult dose IV—50 mg, 100 mg, and above
7. Naloxone HCl (Narcan): No pediatric doses clearly established; 0.01 mg/kg IV (preferably) every 2 to 3 minutes for 2 to 3 doses maximum
8. 50% dextrose injection: 0.5 mg/kg or 1 mL/kg
9. Diazepam (Valium): Dose not clearly established in patients younger than 12 years of age but in the range of 0.1 to 0.5 mg/kg for intractable seizures

Guidelines for Infection Control in Dental Health Care Settings

Principles of infection control require continuous evaluation of current infection control practices. This is necessary in dental practice because of new technologies, materials, equipment, and data. Dental patient care settings also may require specific strategies directed to preventing pathogen transmission among dental health care personnel (DHCP) and their patients.

The Centers for Disease Control and Prevention (CDC) published the *Guidelines for Infection Control in Dental Health-Care Settings—2003* for DHCP. The essential elements of this document still apply for dental practice. The CDC's evidence-based recommendations guide infection control practices in dental offices nationally and globally; provide direction for the public, DHCP, and policymakers; and affect technology development in the dental industry.

Recommended infection control practices continue to be applicable to all settings in which dental treatment is provided (<http://www.cdc.gov/oralhealth/infectioncontrol/#socialMediaShareContainer>).

Dental practitioners should note the following:

CDC Health Advisory: Immediate Need for Healthcare Facilities to Review Procedures for Cleaning, Disinfecting, and Sterilizing Reusable Medical Devices (<https://emergency.cdc.gov/han/han00382.asp>)

Fact Sheets and Frequently Asked Questions for Infection Control in Dental Settings (<http://www.cdc.gov/oralhealth/infectioncontrol/factsheets/>)

Prevention and Control of Seasonal Influenza with Vaccines (2009) (<http://www.cdc.gov/mmwr/PDF/rr/rr58e0724.pdf>)

Dental practitioners should note the CDC recommendations concerning influenza vaccination of health care personnel in the United States.

BACKFLOW PREVENTION AND THE DENTAL OPERATIVE UNIT

Provides guidance and scientific information on the risk of contamination from cross-connections from the dental operative unit. (<http://www.cdc.gov/oralhealth/infectioncontrol/factsheets/backflow.htm>)

SAFE INJECTION PRACTICES IN DENTISTRY

Dental practitioners should follow this set of measures to perform injections in an optimally safe manner for patients, health care personnel, and others. (<http://www.cdc.gov/oralhealth/infectioncontrol/factsheets/safe-injection-practices.htm>)

HEPATITIS B FREQUENTLY ASKED QUESTIONS

These FAQs cover hepatitis B infections, vaccinations, chronic hepatitis B, serology, traveler's health, and more. (<http://www.cdc.gov/hepatitis/>)

OTHER RECOMMENDATIONS

Tuberculosis Infection Control Recommendations

The CDC's guidelines to prevent tuberculosis (TB) transmission in health care settings has changed because of the changing epidemiology of TB as well as dental practice techniques. Dental practitioners should review the CDC's TB infection control recommendations for dental settings and learn how they should be incorporated into an infection control program. (http://www.aacdp.com/docs/2014Symposium/Eklund_ResourceHandout.doc)

Prevention of Methicillin-Resistant *Staphylococcus aureus* Transmission in Dental Health Care Settings

Methicillin-resistant *Staphylococcus aureus* (MRSA) is most often spread from patient to patient through the contaminated hands of health care professionals. The clinical utilization of Standard Precautions has been shown to be an effective strategy in preventing transmission. Learn more at CDC's About MRSA Skin Infections. ([http://jada.ada.org/article/S0002-8177\(14\)65410-6/abstract](http://jada.ada.org/article/S0002-8177(14)65410-6/abstract))

If Saliva Were Red: A Visual Lesson on Infection Control

The video training system, *If Saliva Were Red*, features an 8-minute DVD that uses dental professionals to highlight common infection control and safety flaws; the

cross-contamination dental personnel would see if saliva were red; and how controlling contamination by using personal barrier protection, safe work practices, and effective infection control products reduces the risk of exposure. Produced by the Organization for Safety, Asepsis and Prevention (see link below).

Related Links

- American Dental Association (ADA) Infection Control Resources (<http://www.ada.org/en/member-center/oral-health-topics/infection-control-resources>)
- Guidelines for Infection Control in Dental Health-Care Settings—2003 (<http://www.cdc.gov/oralhealth/infectioncontrol/guidelines/index.htm>)
- National Institute for Occupational Safety and Health (NIOSH) (<http://www.cdc.gov/niosh/topics/bbp/>)
- Organization for Safety, Asepsis and Prevention (<http://www.osap.org/>)
- Safety and Health Topics for Dentistry from the Occupational Safety and Health Administration (OSHA) (<https://www.osha.gov/SLTC/dentistry/index.html>)
- USAF Dental Evaluation and Consultation Service (<http://www.airforcemedicine.af.mil/>)
- Division of Oral Health (<http://www.cdc.gov/oralhealth/index.html>)
- National Center for Chronic Disease Prevention and Health Promotion (<http://www.cdc.gov/chronicdisease>)

Presented in this appendix are the most recent recommendations from the CDC for infection control in dental health care settings. Most of these recommendations are essentially the same as in the 2003 guidelines, with some updates in the prevention of H1N1 influenza transmission in dental health care settings, which were updated in 2009. Also included are a few summary statements (and tables) regarding recommendations for TB infection control.

The CDC believes that dental offices that follow these new recommendations will strengthen an already admirable record of safe dental practice. Patients and providers alike can be assured that oral health care can be delivered and received in a safe manner.

OVERVIEW¹

Recommended infection control practices are applicable to all settings in which dental treatment is provided.

Prevention of 2009 H1N1 Influenza Transmission in Dental Health Care Settings (Updated on November 23, 2009)¹

The CDC provides updated guidance on preventing 2009 H1N1 influenza transmission in dental health care settings. Guidance includes new recommendations on using airborne infection isolation rooms, N95 respirators (i.e., those that

filter at least 95% of airborne particles), and infection control measures for personnel with influenza-like illness.

Tuberculosis Infection Control Recommendations¹

The changing epidemiology of TB and discovery of new diagnostic methods prompted a revision of the CDC's *Guidelines to Prevent TB Transmission in Healthcare Settings*. The revised CDC's TB infection control recommendations for dental settings, as well as information on how they should be incorporated into an infection control program, are available online (see "Additional Resources" later on).

Educational Materials¹

Slide Presentation for Infection Control Guidelines. A slide set and accompanying speaker notes that provide an overview of many of the basic principles of infection control in the CDC's *Guidelines for Infection Control in Dental Health-Care Settings* can be downloaded as a PowerPoint presentation or viewed on the CDC's website.

From Policy to Practice: OSAP's Guide to the Guidelines.* The Organization for Safety & Asepsis Procedures (OSAP) has produced a 170-page workbook that contains practical information to help health care professionals put the infection control recommendations into practice. These resources were produced by OSAP through a CDC cooperative agreement.

Related Organizations

- ADA Infection Control Resources*
- National Institute for Occupational Safety and Health
- Organization for Safety and Asepsis Procedures*
- Safety and Health Topics for Dentistry from the Occupational Safety and Health Administration (OSHA)
- U.S. Air Force (USAF) Dental Evaluation and Consultation Service

PREVENTION OF H1N1 INFLUENZA TRANSMISSION IN DENTAL HEALTH CARE SETTINGS²

Exposures to 2009 H1N1 influenza virus occurs in household, community, and occupational settings, and transmission is thought to occur through droplet exposure of mucosal surfaces; through indirect contact, usually via the hands, with respiratory secretions from an infectious patient or contaminated surface; and through inhalation

*Links to nonfederal organizations do not constitute an endorsement of any organization by the CDC or the federal government, and none should be inferred. The CDC is not responsible for the content of the individual organization web pages found at such links.

of small particle aerosols in the vicinity of the infectious individual.

Symptoms of Influenza

Persons with influenza, including 2009 H1N1 influenza, may have some or all of these symptoms:

- Fever (Note: Not everyone with influenza will have a fever.)
- Cough
- Sore throat
- Runny or stuffy nose
- Body aches
- Headache
- Chills
- Fatigue
- Sometimes diarrhea and vomiting

Control of 2009 H1N1 Influenza

A hierarchy of control measures should be applied to prevent transmission of 2009 H1N1 influenza in all health care settings. To apply the hierarchy of control measures, facilities should take the following steps, ranked according to their likely effectiveness:

1. Elimination of potential exposures (e.g., deferral of treatment for ill patients and source control by masking persons who are coughing)
2. Engineering controls that reduce or eliminate exposure at the source without placing primary responsibility of implementation on individual employees
3. Administrative controls including sick leave policies and vaccination that depend on consistent implementation by management and employees
4. Personal protective equipment (PPE) for exposures that cannot otherwise be eliminated or controlled

(PPE includes gloves, surgical face masks, respirators, protective eyewear, and protective clothing such as gowns.)

Vaccination. Vaccination, an administrative control, is one of the most important interventions for preventing transmission of influenza to health care personnel. More information on this hierarchy of controls is available in the CDC's *Interim Guidance on Infection Control Measures for 2009 H1N1 Influenza in Healthcare Settings, Including Protection of Healthcare Personnel* (see CDC: H1N1 Flu Clinical and Public Health Guidance, <http://www.cdc.gov/h1n1flu/guidance>).

Specific Recommendations for Dental Health Care

- Encourage all DHCP to receive seasonal influenza and 2009 H1N1 influenza vaccinations.
- Use patient reminder calls to identify patients reporting influenza-like illness. Reschedule nonurgent visits until 24 hours after the patient is free of fever without the use of fever-reducing medicine.

- Identify patients with influenza-like illness at check-in; offer a face mask or tissues to symptomatic patients; follow *respiratory hygiene* and *cough etiquette*³ and reschedule nonurgent care. Separate ill patients from others whenever possible if evaluating for urgent care.
- Urgent dental treatment can be performed without the use of an airborne infection isolation (AII) room because transmission of 2009 H1N1 influenza is thought not to occur over longer distances through the air, such as from one patient room to another.
- Use a treatment room with a closed door, if available. If not, use one that is farthest from other patients and personnel.
- Wear recommended PPE before entering the treatment room.
- DHCP should wear a NIOSH fit-tested, disposable N95 respirator when entering the patient room and when performing dental procedures on patients with suspected or confirmed 2009 H1N1 influenza.
- If N95 respirators or fit testing is not available despite reasonable attempts to obtain it, the dental office should switch over to a prioritized use mode (i.e., non-fit-tested disposable N95 respirators or surgical face masks can be considered as a lower level of protection for personnel at lower risk of exposure or lower risk of complication from influenza until fit-tested N95 respirators are available). Detailed information can be found in the CDC's *Interim Guidance on Infection Control Measures for H1N1 Influenza in Healthcare Settings, Including Protection of Healthcare Personnel* (see later under “[Additional Resources](#)”). Additional guidance, including recommendations regarding fit-testing issues, can be found in the related question and answer document regarding respiratory protection (see under “[Additional Resources](#)”).
- As customary, minimize spray and spatter (e.g., use a dental dam and high-volume evacuator).

Dental Health Care Personnel

- DHCP should self-assess daily for symptoms of febrile respiratory illness (fever plus one or more of the following: nasal congestion or runny nose, sore throat, or cough).
- Personnel who develop fever and respiratory symptoms should promptly notify their supervisors and should not report to work.
- Personnel should remain at home until at least 24 hours after they are free of fever (100°F or 37.8°C) or signs of a fever without the use of fever-reducing medications.
- Personnel with a family member who is diagnosed with 2009 H1N1 influenza can still go to work but should self-monitor for symptoms so that any illness is recognized promptly.

Additional Resources

For comprehensive information on the CDC's 2009 H1N1 influenza infection control guidelines, visit Infection Control and Clinician Guidance at <http://www.cdc.gov/h1n1flu/guidance> for access to the following:

- Interim Guidance on Infection Control Measures for 2009 H1N1 Influenza in Healthcare Settings, Including Protection of Healthcare Personnel
- Questions and Answers about CDC's Interim Guidance on Infection Control Measures for 2009 H1N1 Influenza in Healthcare Settings, Including Protection of Healthcare Personnel
- Questions and Answers Regarding Respiratory Protection for Infection Control Measures for 2009 H1N1 Influenza Among Healthcare Personnel
- 10 Steps You Can Take: Actions for Novel H1N1 Influenza Planning and Response for Medical Offices and Outpatient Facilities

Information on swine flu also is available at this website:

- 2009 H1N1 Flu (Swine Flu) (<http://www.cdc.gov/h1n1flu>)

COMPARISON OF SELECTED CHANGES BETWEEN 1994 AND 2005 EDITIONS OF THE CENTERS FOR DISEASE CONTROL AND PREVENTION'S GUIDELINES FOR PREVENTING TUBERCULOSIS IN DENTAL HEALTH CARE SETTINGS⁴

Although rates of TB in the United States have decreased in recent years, disparities in TB incidence still exist between U.S.-born and foreign-born people (people living in the United States but born outside it) and between white people and nonwhite people. In addition, the number of TB outbreaks among health care personnel and patients has decreased since the implementation of the 1994 CDC guidelines to prevent transmission of *Mycobacterium tuberculosis*. Therefore, there are a few updates on the epidemiology of TB, advances in TB diagnostic methods, and TB infection control guidelines for dental settings.

Clinical Implications

Although the principles of TB infection control have remained the same, the changing epidemiology of TB and the advent of new diagnostic methods for TB led to the development of the 2005 update to the 1994 guidelines. DHCP should be aware of the modifications that are pertinent to dental settings and incorporate them into their overall infection control programs.

Tuberculosis Risk Categories and Recommended Testing Frequency⁵

- **Low**—fewer than three patients with unrecognized TB treated in past year: Baseline screening at hiring; further testing not needed unless exposure occurs
- **Medium**—three or more patients with unrecognized TB treated in past year: Baseline screening and then annual testing
- **Potential of ongoing transmission**—evidence of ongoing person-to-person transmission: Baseline screening and then testing every 8 to 10 weeks until evidence of transmission has ceased

Baseline screening should be conducted by a qualified health care professional using a two-step tuberculin skin test or a single blood assay for interferon gamma release.

Tuberculosis Precautions for Outpatient Dental Settings⁵

Administrative Controls

- Assign responsibility for managing TB infection control program.
- Conduct annual risk assessment.
- Develop written TB infection control policies for promptly identifying and isolating patients with suspected or confirmed TB disease for medical evaluation or urgent dental treatment.
- Instruct patients to cover mouth when coughing or wear a surgical mask.
- Ensure that DHCP are educated regarding signs and symptoms of TB.
- When hiring DHCP, ensure that they are screened for latent TB infection and TB disease.
- Postpone urgent dental treatment.

Environmental Controls

- Use airborne infection isolation room to provide urgent dental treatment to patients with suspected or confirmed infectious TB.
- In settings with high volume of patients with suspected or confirmed TB, use high-efficiency particulate air filters or ultraviolet germicidal irradiation.

Respiratory Protection Controls

- Use respiratory protection—at least an N95 filtering face piece (disposable)—for DHCP when they are providing urgent dental treatment to patients with suspected or confirmed TB.
- Instruct patients with TB to cover their mouths when coughing and to wear surgical masks.
- Respiratory hygiene and cough etiquette measures³:
 - Use tissues to cover the nose and mouth and to contain respiratory secretions when coughing or sneezing.

- Dispose of tissues in no-touch receptacles (e.g., those with foot pedal–operated lids or an open, plastic-lined wastebasket).
- When coughing or sneezing, if tissues are not available, cover the mouth and nose with the inner surface of the arm and forearm to keep pathogenic organisms away from the hands. Although *Mycobacterium tuberculosis* cannot be spread by the hands, other respiratory pathogens such as rhinoviruses can be spread in this manner.
- Practice hand hygiene (e.g., hand washing with nonantimicrobial soap and water, alcohol-based hand rub, or antiseptic hand wash) after contact with respiratory secretions or contaminated objects and materials. Hand hygiene is recommended to prevent transmission of all respiratory illnesses in general but will not affect TB transmission.

CLINICAL IMPLICATIONS

The CDC *Guidelines for Infection Control in Dental Health Care Settings—2003*⁶ is a major update and revision of the CDC's *Recommended Infection Control Practices for Dentistry—1993*.⁷ As of 2011, these guidelines still apply (along with the previous updates on H1N1 and TB). As the nation's disease prevention agency, the CDC develops a broad range of guidelines intended to improve the effect and effectiveness of public health interventions and to inform key audiences, most often clinicians, public health practitioners, and the public, about applicable findings.

Why are guidelines needed that are specific for dentistry? More than a half million DHCP work in the United States—approximately 168,000 dentists, 112,000 registered dental hygienists, 218,000 dental assistants,⁸ and 53,000 dental laboratory technicians.⁴ Most dentists are solo practitioners who work in outpatient, ambulatory care facilities. In these settings, no epidemiologists or other hospital infection control experts track possible health care–associated (i.e., nosocomial) infections or monitor and recommend safe practices. Instruments frequently used in dental practice generate spatter, mists, aerosols, or particulate matter. Unless precautions are taken, the possibility is great that patients and DHCP will be exposed to blood and other potentially pathogenic infectious material. Fortunately, by understanding certain principles of disease transmission and using infection control practices based on those principles, dental personnel can prevent disease transmission.

The CDC's first set of infection control recommendations for dentistry was published as an article in the *Morbidity and Mortality Weekly Report* in 1986.⁹ At that time, a position paper from the American Association of Public Health Dentistry commented on the state of dental infection control, noting: "Dental practitioners are virtually the only health care providers who routinely place an ungloved hand into a body cavity."¹⁰ Reports

published from 1970 through 1987 described nine clusters of patients who were believed to be infected with hepatitis B virus (HBV) through treatment by an infected DHCP.¹ However, since 1987, no transmission of HBV from dentist to patient has been reported. This good statistic possibly is the result of widespread acceptance of the hepatitis B vaccine and the adoption of standard (formerly universal) precautions, including routine glove use. HBV seroprevalence among dentists has fallen from about 14% in 1983 to about 9% today—a proportion that is expected to decline to below that for the general population as older dentists retire (because older dentists are more likely than young dentists to be infected) (personal communication, C. Siew, PhD, ADA, 2003).

In early 1988, a published report described a dentist who was seropositive for human immunodeficiency virus (HIV) but had no admitted risk factors for HIV infection, which suggests the possibility of occupational transmission.^{7,11} In addition, during the early 1990s, the health care community was shaken when six cases of transmission from an HIV-infected dentist to his patients were reported.¹²⁻¹⁴ No additional reports have described HIV transmission from HIV-infected DHCP to patients, and since the CDC began surveillance for occupationally acquired HIV, no cases of occupationally acquired HIV have been documented among DHCP.^{11,12}

In 1991, OSHA released the bloodborne pathogen standard that mandated certain practices for all dental offices.¹⁵ For example, employers must provide hepatitis B vaccine for their employees, and all employees must use appropriate personal protective equipment (e.g., gloves, protective eyewear, gowns). After OSHA published its standards, the CDC published *Recommended Infection Control Practices for Dentistry* in 1993.⁷ Those recommendations, which focused on preventing transmission of disease caused by bloodborne pathogens, were based primarily on health care precedent, theoretical rationale, and expert opinion. In contrast with OSHA (which is a regulatory agency), the CDC cannot mandate certain practices; it can only recommend. Nevertheless, many dental licensing boards have adopted the CDC's recommendations, or variations of them, as the infection control standard for dental practice in their states.

The following introductory commentary has been adapted from Kohn WG, Harte JA, Malvitz DM, et al; Centers for Disease Control and Prevention: Guidelines for infection control in dental health care settings—2003, J Am Dent Assoc 135:33-47, 2004. American Dental Association.

Ten years after the 1993 recommendations, new technologies and issues have emerged; the CDC has answered thousands of questions from concerned dental providers and patients about appropriate infection control practices in dental offices. In addition, the CDC has updated or created major guidelines on specific topics such as hand hygiene,

environmental infection control, Mycobacterium tuberculosis, disinfection and sterilization, prophylaxis after exposure to bloodborne pathogens, prevention of surgical site infection, immunization for health care workers, and infection control for health care personnel. Regulatory directives from OSHA, the U.S. Food and Drug Administration (FDA), and the U.S. Environmental Protection Agency (EPA) also affect dental practice.

This new set of CDC recommendations discusses portions of the numerous federal guidelines and regulatory mandates that are relevant to dentistry. It also consolidates previous recommendations and adds new ones specific to infection control in dental health care settings. The new dental guidelines are longer than the 1993 version, principally because they provide more background information and the scientific rationale for the recommendations.

The recommendations cover a broad range of topics and include a number of major updates and additions. Most recommendations are familiar to DHCPs and already are practiced routinely. They are designed to prevent or reduce the potential for disease transmission from patient to DHCP, from DHCP to patient, and from patient to patient. The document emphasizes the use of “standard precautions” (which replaces the term “universal precautions”) for the prevention of exposure to and transmission not only of bloodborne pathogens but also of other pathogens encountered in oral health care settings. Although the guidelines focus mainly on practices in outpatient, ambulatory dental health care settings, the recommended infection control practices are applicable to all settings in which dental treatment is provided.

In the recommendations, the term DHCP refers to all paid and unpaid personnel in dental health care who could experience occupational exposure to infectious materials, including body substances and contaminated supplies, equipment, environmental surfaces, water, or air. DHCP include dentists, dental hygienists, dental assistants, dental laboratory technicians (in-office and commercial), students and trainees, contract personnel, and other persons who are not directly involved in patient care but who could be exposed to infectious agents (such as administrative, clerical, housekeeping, maintenance, or volunteer personnel).

The guidelines have two parts. The first part provides the background and scientific evidence on which recommendations are based. More than 450 articles are referenced. From the CDC online version (www.cdc.gov/oralhealth/infectioncontrol), readers who want more information on particular topics can link to key reference documents such as the OSHA Bloodborne Pathogen Standard and other CDC infection control guidelines. The second part

lists the recommendations and explains the ranking system for the level of scientific evidence for each recommendation.

Varying levels of scientific evidence support infection control practices in health care settings—and in dental settings specifically. Whenever possible, recommendations in the guidelines are based on data from well-designed scientific studies. However, only a limited number of studies have characterized the risk factors for contracting an infection in a dental office and the effectiveness of measures to prevent infection. Certain infection control practices routinely used by health care practitioners cannot be examined rigorously for ethical or logistical reasons. Because there are no scientific studies to support certain recommended practices, they are based instead on strong theoretical rationale, suggestive evidence, or the opinions of respected authorities. Those authorities base their opinions on clinical experience, descriptive studies, or committee reports. Some recommendations are derived from federal regulations. No recommendations are offered for practices for which insufficient scientific evidence exists or for which there is a lack of consensus to support their effectiveness in dental settings.

The full recommendations and ranking system follow. Reference numbers that appear in parentheses in the Recommendations section of this [Appendix] relate to the first part of the full set of guidelines. Although the reference list is omitted from this [Appendix] in the interest of [saving] space, reference numbers were left in the text to allow readers who copy this [Appendix] to match it later with the full document.

The CDC’s new guidelines for infection control in dental health care settings should provide dental practitioners with the information needed to make informed and intelligent choices when they select infection control processes, methods, and products. Although most dental practices will find that they already are carrying out most of the recommendations in the guidelines, they now will have the scientific rationale that underlies these recommendations. The practice of infection control in dentistry has made remarkable progress since the 1980s, and the CDC believes that dental offices that follow these new recommendations will strengthen an already admirable record of safe dental practice. Patients and providers alike can be assured that oral health care can be delivered and received in a safe manner.

The CDC plans to distribute these guidelines broadly to the dental community through organizational mailing lists. In addition, the guidelines will be accessible at www.cdc.gov/oralhealth. Soon, the CDC oral health website also will include a

PowerPoint slide series that can be downloaded for the purpose of staff education.

The following recommendations are from the Centers for Disease Control and Prevention. *Guidelines for Infection Control in Dental Health-Care Settings*—2003. MMWR 52(No. RR-17): 39-48, 2003. See also <http://www.cdc.gov/mmwr/pdf/rr/rr5217.pdf>

Each recommendation is categorized on the basis of existing scientific data, theoretical rationale, and applicability. Rankings are based on the system used by the CDC and the Healthcare Infection Control Practices Advisory Committee (HICPAC) to categorize recommendations:

- Category IA—strongly recommended for implementation and strongly supported by well-designed experimental, clinical, or epidemiologic studies
- Category IB—strongly recommended for implementation and supported by experimental, clinical, or epidemiologic studies and a strong theoretical rationale
- Category IC—required for implementation as mandated by federal or state regulations or standards. When IC is used, a second rating can be included to provide the basis of existing scientific data, theoretical rationale, and applicability. Because of state differences, readers should not assume that the absence of a IC recommendation implies the absence of any state regulations.
- Category II—suggested for implementation and supported by suggestive clinical or epidemiologic studies or a theoretical rationale
- Unresolved issue—no recommendation. Insufficient evidence or no consensus regarding efficacy exists.

I. PERSONNEL HEALTH ELEMENTS OF AN INFECTION CONTROL PROGRAM

A. General Recommendations

1. Develop a written health program for DHCP that includes policies, procedures, and guidelines for education and training; immunizations; exposure prevention and postexposure management; medical conditions, work-related illness, and associated work restrictions; contact dermatitis and latex hypersensitivity; and maintenance of records, data management, and confidentiality (IB) (5,16-18,22).
2. Establish referral arrangements with qualified health care professionals to ensure prompt and appropriate provision of preventive services, occupationally

related medical services, and postexposure management with medical follow-up (IB, IC) (5,13,19,22).

B. Education and Training

1. Provide DHCP (1) on initial employment, (2) when new tasks or procedures affect the employee's occupational exposure, and (3) at a minimum, annually, education and training regarding occupational exposure to potentially infectious agents and infection control procedures/protocols appropriate for and specific to assigned duties (IB, IC) (5,11,13,14,16,19,22).
2. Provide educational information appropriate in content and vocabulary to the educational level, literacy, and language of DHCP (IB, IC) (5,13).

C. Immunization Programs

1. Develop a written comprehensive policy on immunizing DHCP, including a list of all required and recommended immunizations (IB) (5,17,18).
2. Refer DHCP to a prearranged qualified health care professional or to their own health care professional to receive all appropriate immunizations based on the latest recommendations, as well as their medical history and risk for occupational exposure (IB) (5,17).

D. Exposure Prevention and Postexposure Management

1. Develop a comprehensive postexposure management and medical follow-up program (IB, IC) (5,13,14,19).
 - a. Include policies and procedures for prompt reporting, evaluation, counseling, treatment, and medical follow-up of occupational exposures.
 - b. Establish mechanisms for referral to a qualified health care professional for medical evaluation and follow-up.
 - c. Conduct a baseline tuberculin skin test (TST), preferably through a 2-step test, for all DHCP who might have contact with persons with suspected or confirmed infectious TB, regardless of the risk classification of the setting (IB) (20).

E. Medical Conditions, Work-Related Illness, and Work Restrictions

1. Develop and have readily available to all DHCP comprehensive written policies on work restriction and exclusion that include a statement of authority defining who can implement such policies (IB) (5,22).

2. *Develop policies for work restriction and exclusion that encourage DHCP to seek appropriate preventive and curative care and report their illnesses, medical conditions, or treatments that can render them more susceptible to opportunistic infection or exposure; do not penalize DHCP with loss of wages, benefits, or job status (IB) (5,22).*
 3. *Develop policies and procedures for evaluation, diagnosis, and management of DHCP with suspected or known occupational contact dermatitis (IB) (32).*
 4. *Seek definitive diagnosis by a qualified health care professional for any DHCP with suspected latex allergy to carefully determine its specific etiology and appropriate treatment, as well as work restrictions and accommodations (IB) (32).*
- F. *Maintenance of Records, Data Management, and Confidentiality*
1. *Establish and maintain confidential medical records (e.g., immunization records, documentation of tests received as a result of occupational exposure) for all DHCP (IB, IC) (5,13).*
 2. *Ensure that the practice complies with all applicable federal, state, and local laws regarding medical record keeping and confidentiality (IC) (13,34).*
- ## II. PREVENTING TRANSMISSION OF BLOODBORNE PATHOGENS
- ### A. HBV Vaccination
1. *Offer the HBV vaccination series to all DHCP with potential occupational exposure to blood or other potentially infectious material (IA, IC) (2,13,14,19).*
 2. *Always follow U.S. Public Health Service/CDC recommendations for hepatitis B vaccination, serologic testing, follow-up, and booster dosing (IA, IC) (13,14,19).*
 3. *Test DHCP for anti-HBs 1 to 2 months after completion of the three-dose vaccination series (IA, IC) (14,19).*
 4. *DHCP should complete a second three-dose vaccine series or be evaluated to determine if HBsAg-positive if no antibody response occurs to the primary vaccine series (IA, IC) (14,19).*
 5. *Retest for anti-HBs at completion of the second vaccine series. If no response to the second three-dose series, nonresponders should be tested for HBsAg (IC) (14,19).*
- ### B. Preventing Exposures to Blood and Other Potentially Infectious Material (OPIM)
1. *General recommendations*
 - a. *Use standard precautions (OSHA's bloodborne pathogen standard retains the term universal precautions) for all patient encounters (IA, IC) (11,13,19,53).*
 - b. *Consider sharp items (e.g., needles, scalers, burs, laboratory knives, and wires) that are contaminated with patient blood and saliva as potentially infective, and establish engineering controls and work practices to prevent injuries (IB, IC) (6,13,113).*
 - c. *Implement a written, comprehensive program designed to minimize and manage DHCP exposures to blood and body fluids (IB, IC) (13,14,19,97).*
 2. *Engineering and work practice controls*
 - a. *Identify, evaluate, and consider devices with engineered safety features at least annually and as they become available on the market (e.g., safer anesthetic syringes, blunt suture needle, retractable scalpel, or needleless IV systems) (IC) (13,97,110-112).*
 - b. *Place used disposable syringes and needles, scalpel blades, and other sharp items in appropriate puncture-resistant containers located as close as feasible to the area in which the items are used (IA, IC) (2,7,13,19,113,115).*
 - c. *Do not recap used needles by using both hands or any other technique that involves directing the point of a needle toward any part of the body. Do not bend, break, or remove needles before disposal (IA, IC) (2,7,8,13,97,113).*
 - d. *Use a one-handed scoop technique or a mechanical device designed for*

holding the needle cap when recapping needles (e.g., between multiple injections, before removing from a nondisposable aspirating syringe) (IA, IC) (2,7,8,13,14,113).

3. *Postexposure management and prophylaxis*
 - a. *Follow current CDC recommendations after percutaneous, mucous membrane, or nonintact skin exposure to blood or other potentially infectious material (IA, IC) (13, 14,19).*

III. HAND HYGIENE

A. General Considerations

1. *Perform hand hygiene with a nonantimicrobial or antimicrobial soap and water when hands are visibly dirty or are contaminated with blood or other potentially infectious material. If hands are not visibly soiled, an alcohol-based handrub can also be used. Follow the manufacturer's instructions (IA) (123).*
2. *Indications for hand hygiene include the following:*
 - a. *When hands are visibly soiled (IA, IC)*
 - b. *After barehanded touching of inanimate objects likely to be contaminated by blood, saliva, or respiratory secretions (IA, IC)*
 - c. *Before and after treating each patient (IB)*
 - d. *Before donning gloves (IB)*
 - e. *Immediately after removing gloves (IB, IC) (7-9,11,13,113,120-123, 125,126, 138).*
3. *For oral surgical procedures, perform surgical hand antisepsis before donning sterile surgeon's gloves. Follow the manufacturer's instructions by using an antimicrobial soap and water, or soap and water followed by drying of hands and application of an alcohol-based surgical hand scrub product with persistent activity (IB) (121-123,127-133, 137,144,145).*
4. *Store liquid hand care products in disposable closed containers or closed containers that can be washed and dried before refilling. Do not add soap or lotion (i.e., top off) to a partially empty dispenser (IA) (9,120,122,149, 150).*

B. Special Considerations for Hand Hygiene and Glove Usage

1. *Use hand lotions to prevent skin dryness associated with handwashing (IA) (153,154).*
2. *Consider the compatibility of lotion and antiseptic products and the effects of petroleum or other oil emollients on the integrity of gloves during product selection and glove usage (IB) (2,14,122,155).*
3. *Keep fingernails short with smooth, filed edges to allow thorough cleaning and to prevent glove tears (II) (122,123,156).*
4. *Do not wear artificial fingernails or extenders when having direct contact with patients at high risk (e.g., those in intensive care units or operating rooms) (IA) (123,157-160).*
5. *Use of artificial fingernails usually is not recommended (II) (157-160).*
6. *Do not wear hand or nail jewelry if it makes donning gloves more difficult or compromises the fit and integrity of the glove (II) (123,142,143).*

IV. PERSONAL PROTECTIVE EQUIPMENT (PPE)

A. Masks, Protective Eyewear, Face Shields

1. *Wear a surgical mask and eye protection with solid side shields or a face shield to protect mucous membranes of the eyes, nose, and mouth during procedures likely to generate splashing or spattering of blood or other body fluids (IB, IC) (1,2,7,8,11,13,137).*
2. *Change masks between patients or during patient treatment if the mask becomes wet (IB) (2).*
3. *Clean with soap and water or, if visibly soiled, clean and disinfect reusable facial protective equipment (e.g., clinician and patient protective eyewear or face shields) between patients (II) (2).*

B. Protective Clothing

1. *Wear protective clothing such as a reusable or disposable gown, laboratory coat, or uniform that covers personal clothing and skin (e.g., forearms) likely to be soiled with blood, saliva, or OPIM (IB, IC) (7,8,11,13,137).*
2. *Change protective clothing if visibly soiled (134); change immediately or as soon as feasible if penetrated by blood or other potentially infectious fluids (IB, IC) (13).*
3. *Remove barrier protection, including gloves, mask, eyewear, and gown, before*

departing work area (e.g., dental patient care, instrument processing, laboratory areas) (IC) (13).

C. Gloves

1. Wear medical gloves when the potential exists for contacting blood, saliva, OPIM, or mucous membranes (IB, IC) (1,2,7,8,13).
2. Wear a new pair of medical gloves for each patient, remove them promptly after use, and wash hands immediately to avoid transfer of microorganisms to other patients or environments (IB) (1,7,8,123).
3. Remove gloves that are torn, cut, or punctured as soon as feasible, and wash hands before regloving (IB, IC) (13,210,211).
4. Do not wash surgeon's or patient examination gloves before use or wash, disinfect, or sterilize gloves for reuse (IB, IC) (13,138,177,212,213).
5. Ensure that appropriate gloves in the correct size are readily accessible (IC) (13).
6. Use appropriate gloves (e.g., puncture- and chemical-resistant utility gloves) when cleaning instruments and performing housekeeping tasks involving contact with blood or OPIM (IB, IC) (7,13,15).
7. Consult with glove manufacturers regarding the chemical compatibility of glove material and dental materials used (II).

D. Sterile Surgeon's Gloves and Double Gloving During Oral Surgical Procedures

1. Wear sterile surgeon's gloves when performing oral surgical procedures (IB) (2,8,137).
2. No recommendation is offered regarding the effectiveness of wearing two pairs of gloves to prevent disease transmission during oral surgical procedures. The majority of studies among HCP and DHCP have demonstrated a lower frequency of inner glove perforation and visible blood on the surgeon's hands when double gloves are worn; however, the effectiveness of wearing two pair of gloves in preventing disease transmission has not been demonstrated (Unresolved issue).

V. CONTACT DERMATITIS AND LATEX HYPERSENSITIVITY

A. General Recommendations

1. Educate DHCP regarding the signs, symptoms, and diagnoses of skin

reactions associated with frequent hand hygiene and glove use (IB) (5,31,32).

2. Screen all patients for latex allergy (e.g., take health history) and refer for medical consultation when latex allergy is suspected (IB) (32).
3. Ensure a latex-safe environment for patients and DHCP with latex allergy (IB) (32).
4. Have emergency treatment kits with latex-free products available at all times (II) (32).

VI. STERILIZATION AND DISINFECTION OF PATIENT CARE ITEMS

A. General Recommendations

1. Use only FDA-cleared medical devices for sterilization, and follow the manufacturer's instructions for correct use (IB) (248).
2. Clean and heat sterilize critical dental instruments before each use (IA) (2,243,244,246,249,407).
3. Clean and heat sterilize semicritical items before each use (IB) (2,249,260,407).
4. Allow packages to dry in the sterilizer before they are handled, to avoid contamination (IB) (247).
5. Use of heat-stable semicritical alternatives is encouraged (IB) (2).
6. Reprocess heat-sensitive critical and semicritical instruments by using FDA-cleared sterilant/high-level disinfectants or an FDA-cleared low-temperature sterilization method (e.g., ethylene oxide). Follow manufacturer's instructions for use of chemical sterilants/high-level disinfectants (IB) (243).
7. Single-use disposable instruments are acceptable alternatives, provided they are used only once and disposed of correctly (IB, IC) (243,383).
8. Do not use liquid chemical sterilants/high-level disinfectants for environmental surface disinfection or as holding solutions (IB, IC) (243,245).
9. Ensure that noncritical patient care items are barrier protected or cleaned, or, if visibly soiled, cleaned and disinfected after each use with an EPA-registered hospital disinfectant with an HIV/HBV effectiveness claim (low-level disinfectant) or a tuberculocidal claim (intermediate-level disinfectant) (i.e., intermediate level

if visibly contaminated with blood or OPIM) (IB) (2,243,244).

10. *Inform DHCP of all OSHA guidelines for exposure to chemical agents used for disinfection and sterilization. Using this report, identify areas and tasks that have potential for exposure (IC) (15).*
- B. Instrument Processing Area**
1. *Designate a central processing area. Divide the instrument processing area, physically or, at a minimum, spatially, into distinct areas for (1) receiving, cleaning, and decontamination; (2) preparation and packaging; (3) sterilization; and (4) storage. Do not store instruments in an area where contaminated instruments are held or cleaned (II) (174,247,248).*
 2. *Train DHCP to employ work practices that prevent contamination of clean areas (II).*
- C. Receiving, Cleaning, and Decontaminating Work Area**
1. *Minimize handling of loose contaminated instruments during transport to the instrument processing area. Use work practice controls (e.g., carry instruments in a covered container) to minimize exposure potential (II). Clean all visible blood and other contamination from dental instruments and devices before sterilization or disinfection procedures (IA) (249-252).*
 2. *Use automated cleaning equipment (e.g., ultrasonic cleaner or washer/disinfector) to remove debris to improve cleaning effectiveness and decrease worker exposure to blood (IB) (2,253).*
 3. *Use work practice controls that minimize contact with sharp instruments, if manual cleaning is necessary (e.g., long-handled brush) (IC) (14).*
 4. *Wear puncture- and chemical-resistant/heavy duty utility gloves for instrument cleaning and decontamination procedures (IB) (7).*
 5. *Wear appropriate PPE (e.g., mask, protective eyewear and gown) when splashing or spraying is anticipated during cleaning (IC) (13).*
- D. Preparation and Packaging**
1. *Use an internal chemical indicator in each package. If the internal indicator cannot be seen from outside the package, also use an external indicator (II) (243,254,257).*
 2. *Use a container system or wrapping compatible with the type of sterilization process used and that has received FDA clearance (IB) (243,247,256).*
3. *Before sterilization of critical and semicritical instruments, inspect instruments for cleanliness, then wrap or place them in containers designed to maintain sterility during storage (e.g., cassettes, organizing trays) (IA) (2,247, 255,256).*
- E. Sterilization of Unwrapped Instruments**
1. *Clean and dry instruments prior to the unwrapped sterilization cycle (IB) (248).*
 2. *Use mechanical and chemical (place an internal chemical indicator among the instruments or items to be sterilized) indicators for each unwrapped sterilization cycle (IB) (258).*
 3. *Allow unwrapped instruments to dry and cool in the sterilizer before they are handled, to avoid contamination and thermal injury (II) (260).*
 4. *Semicritical instruments that will be used immediately or within a short time frame can be sterilized unwrapped on a tray or in a container system, provided that the instruments are handled aseptically during removal from the sterilizer and transport to the point of use (II).*
 5. *Critical instruments intended for immediate reuse can be sterilized unwrapped, provided that the instruments are maintained sterile during removal from the sterilizer and transport to the point of use (e.g., transported in a sterile, covered container) (IB) (258).*
 6. *Do not sterilize implantable devices unwrapped (IB) (243,247).*
 7. *Do not store critical instruments unwrapped (IB) (248).*
- F. Sterilization Monitoring**
1. *Use mechanical, chemical, and biologic monitors according to the manufacturer's instructions to ensure the effectiveness of the sterilization process (IB) (248,278,279).*
 2. *Monitor each load with mechanical (e.g., time, temperature, pressure) and chemical indicators (II) (243,248).*
 3. *Place a chemical indicator on the inside of each package. If the internal indicator is not visible from the outside, also place an exterior chemical indicator on the package (II) (243,254,257).*
 4. *Place items/packages correctly and loosely into the sterilizer, so as not to impede penetration of the sterilant (IB) (243).*

5. Do not use instrument packs if mechanical or chemical indicators indicate inadequate processing (IB) (243,247,248).
 6. Monitor sterilizers at least weekly by using a biologic indicator with a matching control (i.e., biologic indicator and control from the same lot number) (IB) (2,9,243,247,278,279).
 7. Use a biologic indicator for every sterilizer load that contains an implantable device. Verify results before using the implantable device, whenever possible (IB) (243,248).
 8. The following are recommended in the case of a positive spore test:
 - a. Remove the sterilizer from service, and review sterilization procedures (e.g., work practices, use of mechanical and chemical indicators) to determine whether operator error could be responsible (II) (8)
 - b. Retest the sterilizer by using biologic, mechanical, and chemical indicators after correcting any identified procedural problems (II)
 - c. If the repeat spore test is negative, and mechanical and chemical indicators are within normal limits, put the sterilizer back in service (II) (9,243).
 9. The following are recommended if the repeat spore test is positive:
 - a. Do not use the sterilizer until it has been inspected or repaired, or the exact reason for the positive test has been determined (II) (9,243)
 - b. Recall, to the extent possible, and reprocess all items processed since the last negative spore test (IB) (9,283)
 - c. Before placing the sterilizer back in service, rechallenge the sterilizer with biologic indicator tests in three consecutive empty chamber sterilization cycles after the cause of sterilizer failure has been determined and corrected (II) (9,283).
 10. Maintain sterilization records (i.e., mechanical, chemical, and biological) in compliance with state and local regulations (IB) (243).
- G. Storage Area for Sterilized Items and Clean Dental Supplies
1. Implement practices based on date- or event-related shelf-life for the storage of wrapped, sterilized instruments and devices (IB) (243,284).
 2. Even for event-related packaging, at a minimum, place the date of sterilization and, if multiple sterilizers are used in the facility, the sterilizer used on the outside of the packaging material to facilitate the retrieval of processed items in the event of a sterilization failure (IB) (243,247).
 3. Examine wrapped packages of sterilized instruments before opening them, to ensure the barrier wrap has not been compromised during storage (II) (243,284).
 4. Reclean, repack, and resterilize any instrument package that has been compromised (II).
 5. Store sterile items and dental supplies in covered or closed cabinets, if possible (II) (285).
- VII. ENVIRONMENTAL INFECTION CONTROL
- A. General Recommendations
1. Follow the manufacturers' instructions for correct use of cleaning and EPA-registered hospital disinfecting products (IB, IC) (243-245).
 2. Do not use liquid chemical sterilants/high-level disinfectants for disinfection of environmental (clinical contact or housekeeping) surfaces (IB, IC) (243-245).
 3. Use PPE, as appropriate, when cleaning and disinfecting environmental surfaces. Such equipment might include gloves (e.g., puncture- and chemical-resistant utility), protective clothing (e.g., gown, jacket, lab coat), and protective eyewear/face shield and mask (IC) (13,15).
- B. Clinical Contact Surfaces
1. Use surface barriers to protect clinical contact surfaces, particularly those that are difficult to clean (e.g., switches on dental chairs), and change surface barriers between patients (II) (1,2,260,288).
 2. Clean and disinfect clinical contact surfaces that are not barrier protected, by using an EPA-registered hospital low- (i.e., HIV and HBV label claims) to intermediate-level disinfectant (i.e., tuberculocidal claim). Use an intermediate-level disinfectant if visibly contaminated with blood (IB) (2,243,244).
- C. Housekeeping Surfaces
1. Clean housekeeping surfaces (e.g., floors, walls, sinks) with a detergent

and water or an EPA-registered hospital disinfectant/detergent on a routine basis, depending on the nature of the surface and type and degree of contamination and, as appropriate, location in the facility, and when visibly soiled (IB) (243,244).

2. Clean mops and cloths after use and allow to dry before reuse, or use single-use, disposable mopheads or cloths (II) (244).
3. Prepare fresh cleaning or EPA-registered disinfecting solutions daily and as instructed by the manufacturer (II) (243,244).
4. Clean walls, blinds, and window curtains in patient care areas when they are visibly dusty or soiled (II) (9,244).

D. Spills of Blood and Body Substances

1. Clean spills of blood or OPIM, and decontaminate surface with an EPA-registered hospital disinfectant of low (i.e., HBV and HIV label claims) to intermediate level (i.e., tuberculocidal claim), depending on the size of the spill and surface porosity (IB, IC) (13,113).

E. Carpet and Cloth Furnishings

1. Avoid using carpeting and cloth-upholstered furnishings in dental operatories, laboratories, and instrument processing areas (II) (9,293-295).

F. Regulated Medical Waste

1. General recommendations
 - a. Develop a medical waste management program. Disposal of regulated medical waste must follow federal, state, and local regulations (IC) (13,301).
 - b. Ensure that DHCP who handle and dispose of potentially infective wastes are trained in appropriate handling and disposal methods and informed of possible health and safety hazards (IC) (13).
2. Management of regulated medical waste in dental health care facilities
 - a. Use a color-coded or labeled container that prevents leakage (e.g., biohazard bag) to contain nonsharp, regulated medical waste (IC) (13).
 - b. Place sharp items (e.g., needles, scalpel blades, orthodontic bands, broken metal instruments, burs) in an appropriate sharps container (i.e., puncture resistant, color coded, and leakproof). Close container immediately before removal or replacement to prevent

spillage or protrusion of contents during handling, storage, transport, or shipping (IC) (2,8,13,113,115).

- c. Pour blood, suctioned fluids, or other liquid waste into a drain connected to a sanitary sewer system, if local sewage discharge requirements are met and the state has declared this an acceptable method of disposal. Wear appropriate PPE while performing this task (IC) (7,9,13).

VIII. DENTAL UNIT WATER LINES, BIOFILM, AND WATER QUALITY

A. General Recommendations

1. Use water that meets EPA regulatory standards for drinking water (i.e., 500 CFU/mL of heterotropic water bacteria) for routine dental treatment output water (IB, IC) (341,342).
2. Consult with the dental unit manufacturer for appropriate methods and equipment to maintain the recommended quality of dental water (II) (339).
3. Follow recommendations for monitoring water quality provided by the manufacturer of the unit or water line treatment product (II).
4. Discharge water and air for a minimum of 20-30 seconds after each patient, from any device connected to the dental water system that enters the patient's mouth (e.g., handpieces, ultrasonic scalers, air/water syringes) (II) (2,311,344).
5. Consult with the dental unit manufacturer the need for periodic maintenance of antiretraction mechanisms (IB) (2,311).

B. Boil-Water Advisories

1. The following apply while a boil-water advisory is in effect:
 - a. Do not deliver water from the public water system to the patient through the dental operative unit, ultrasonic scaler, or other dental equipment that uses the public water system (IB, IC) (341,342,346,349,350).
 - b. Do not use water from the public water system for dental treatment, patient rinsing, or handwashing (IC) (341,342,346,349,350).
 - c. For handwashing, use antimicrobial-containing products that do not require water for use (e.g., alcohol-based handrubs). If hands are visibly contaminated, use bottled water, if

- available, and soap or an antiseptic towelette (IB, IC) (13,122).
2. The following apply when a boil-water advisory is canceled:
 - a. Follow guidance given by the local water utility on adequate flushing of water lines. If no guidance is provided, flush dental water lines and faucets for 1 to 5 minutes before using for patient care (IC) (244, 346,351,352).
 - b. Disinfect dental water lines as recommended by the dental unit manufacturer (II).

IX. SPECIAL CONSIDERATIONS

A. Dental Handpieces and Other Devices Attached to Air and Water Lines

1. Clean and heat sterilize handpieces and other intraoral instruments that can be removed from the air and water lines of dental units between patients (IB, IC) (2,246,275,356,357,360,407).
2. Follow the manufacturer's instructions for cleaning, lubrication, and sterilization of handpieces and other intraoral instruments that can be removed from the air and water lines of dental units (IB) (361-363).
3. Do not surface-disinfect or use liquid chemical sterilants or ethylene oxide on handpieces and other intraoral instruments that can be removed from the air and water lines of dental units (IC) (2,246,250,275).
4. Do not advise patients to close their lips tightly around the tip of the saliva ejector to evacuate oral fluids (II) (364-366).

B. Dental Radiology

1. Wear gloves when exposing radiographs and handling contaminated film packets. Use other PPE (e.g., protective eyewear, mask and gown) as appropriate if spattering of blood or other body fluids is likely (IA, IC) (11,13).
2. Use heat-tolerant or disposable intraoral devices whenever possible (e.g., film-holding and positioning devices). Clean and heat sterilize heat-tolerant devices between patients. At a minimum, use high-level disinfectant on semicritical heat-sensitive devices, according to manufacturer's instructions (IB) (243).
3. Transport and handle exposed radiographs in an aseptic manner to prevent contamination of developing equipment (II).

4. The following apply for digital radiography sensors:
 - a. Use FDA-cleared barriers (IB) (243).
 - b. Clean and heat-sterilize, or high-level disinfect, barrier-protected semicritical items. If the item cannot tolerate these procedures, then, at a minimum, protect with an FDA-cleared barrier, and clean and disinfect with an EPA-registered hospital disinfectant product with intermediate-level (i.e., tuberculocidal claim) activity, between patients. Consult with the manufacturer for methods of disinfection and sterilization of digital radiology sensors and for protection of associated computer hardware (IB) (243).

C. Aseptic Technique for Parenteral Medications

1. Do not administer medication from a syringe to multiple patients even if the needle on the syringe is changed (IA) (378).
2. Use single-dose vials for parenteral medications when possible (II) (376,377).
3. Do not combine the leftover contents of single-use vials for later use (IA) (376,377).
4. The following apply if multiple-dose vials are used:
 - a. Clean the access diaphragm with 70% alcohol before inserting a device into the vial (IA) (380,381).
 - b. Use a sterile device to access a multiple-dose vial, and avoid touching the access diaphragm. Both the needle and syringe used to access the multiple-dose vial must be sterile. Do not reuse a syringe even if the needle is changed (IA) (380,381).
 - c. Keep multiple-dose vials away from the immediate patient treatment area to prevent inadvertent contamination by spray or spatter (II).
 - d. Discard the multiple-dose vial if sterility is compromised (IA) (380,381).
5. Use fluid infusion and administration sets (i.e., IV bags, tubings, connections) for one patient only, and dispose of appropriately (IB) (378).

D. Single-Use (Disposable) Devices

1. Use single-use devices for one patient only, and dispose of them appropriately (IC) (383).

E. Preprocedural Mouth Rinses

1. No recommendation is offered on using preprocedural antimicrobial mouth rinses

to prevent clinical infection among DHCP or patients. Although studies have demonstrated that a preprocedural antimicrobial rinse (e.g., chlorhexidine gluconate, essential oils, povidone-iodine) can reduce the level of oral microorganisms in aerosols and spatter generated during routine dental procedures, and can decrease the number of microorganisms introduced into the patient's bloodstream during invasive dental procedures (391-399), scientific evidence is inconclusive that the use of these rinses prevents clinical infection among DHCP or patients (see discussion *Special Considerations: Preprocedural Mouth Rinses*) (Unresolved issue).

F. Oral Surgical Procedures

1. The following apply when performing oral surgical procedures:
 - a. Perform surgical hand antisepsis by using an antimicrobial product (e.g., antimicrobial soap and water, soap and water followed by alcohol-based hand scrub with persistent activity) (IB) (127-132,137).
 - b. Use sterile surgeon's gloves (IB) (2,7,121,123,137).
 - c. Use sterile saline or sterile water as a coolant/irrigator when performing oral surgical procedures. Use devices specifically designed for the delivery of sterile irrigating fluids (e.g., bulb syringe, single-use disposable products, sterilizable tubing) (IB) (2,121).

G. Handling of Biopsy Specimens

1. During transport, place biopsy specimens in a sturdy, leakproof container labeled with the biohazard symbol (IC) (2,13,14).
2. If a biopsy specimen container is visibly contaminated, clean and disinfect the outside of a container, or place it in an impervious bag labeled with the biohazard symbol (IC) (2,13).

H. Handling of Extracted Teeth

1. Dispose of extracted teeth as regulated medical waste unless returned to the patient (IC) (13,14).
2. Do not dispose of extracted teeth containing amalgam in regulated medical waste intended for incineration (II).
3. Clean and place extracted teeth in a leakproof container, labeled with a biohazard symbol, and maintain hydration, for transport to educational

institutions or a dental laboratory (IB, IC) (13,14).

4. Heat-sterilize teeth that do not contain amalgam, before they are used for educational purposes (IB) (403,405,406).
- #### I. Dental Laboratory
1. Use PPE when handling items received in the laboratory, until they have been decontaminated (IA, IC) (2,7,11,13,113).
 2. Before they are handled in the laboratory, clean, disinfect and rinse all dental prostheses and prosthodontic materials (e.g., impressions, bite registrations, occlusal rims and extracted teeth) by using an EPA-registered hospital disinfectant having at least an intermediate level of activity (i.e., tuberculocidal claim) (IB) (2,249,252,407).
 3. Consult with manufacturers regarding the stability of specific materials (e.g., impression materials) relative to disinfection procedures (II).
 4. Include specific information regarding disinfection techniques used (e.g., solution used and duration) when laboratory cases are sent off-site and on their return (II) (2,407,409).
 5. Clean and heat sterilize heat-tolerant items used in the mouth (e.g., metal impression trays and face-bow forks) (IB) (2,407).
 6. Follow manufacturers' instructions for cleaning and sterilizing or disinfecting items that become contaminated but do not normally contact the patient (e.g., burs, polishing points, rag wheels, articulators, case pans, lathes). If manufacturer instructions are not available, clean and heat sterilize heat-tolerant items, or clean and disinfect with an EPA-registered hospital disinfectant with low- (HIV/HBV effectiveness claim) to intermediate-level (i.e., tuberculocidal claim) activity, depending on the degree of contamination (II).
- #### J. Laser/Electrosurgery Plumes/Surgical Smoke
1. No recommendation is offered on practices to reduce DHCP exposure to laser plumes/surgical smoke when using lasers in dental practice. Practices to reduce HCP exposure to laser plumes/surgical smoke have been suggested, including use of (a) standard precautions (e.g., high-filtration surgical masks, possibly full face shields) (437), (b) central room suction units with in-line filters to collect particulate matter from

minimal plumes, and (c) dedicated mechanical smoke exhaust systems with a high-efficiency filter to remove substantial amounts of laser plume particles. The effect of exposure (e.g., disease transmission, adverse respiratory effects) to DHCP from dental applications of lasers has not been adequately evaluated (see previous discussion, *Special Considerations: Laser/Electrosurgery Plumes or Surgical Smoke*) (Unresolved issue).

K. *Mycobacterium tuberculosis*

1. General recommendations

- a. Educate all DHCP regarding the recognition of signs, symptoms, and transmission of TB (IB) (20,21).
- b. Conduct a baseline tuberculin skin test (TST), preferably by using a two-step test, for all DHCP who might have contact with persons with suspected or confirmed active TB, regardless of the risk classification of the setting (IB) (20).
- c. Assess each patient for a history of TB as well as symptoms suggestive of TB, and document on the medical history form (IB) (20,21).
- d. Follow CDC recommendations for (1) developing, maintaining, and implementing a written TB infection control plan, (2) managing a patient with suspected or active TB, (3) completing a community risk assessment to guide employee TSTs and follow-up, and (4) managing DHCP with TB disease (IB) (2,21).

2. The following apply for patients known or suspected to have active TB:

- a. Evaluate the patient away from other patients and DHCP. When not being evaluated, the patient should wear a surgical mask or be instructed to cover the mouth and nose when coughing or sneezing (IB) (20,21).
- b. Defer elective dental treatment until the patient is noninfectious (IB) (20,21).
- c. Refer patients requiring urgent dental treatment to a previously identified facility with TB engineering controls and a respiratory protection program (IB) (20,21).

L. *Creutzfeldt-Jakob Disease and Other Prion Diseases*

1. No recommendation is offered regarding use of special precautions, in addition to standard precautions, when treating

known CJD or vCJD patients. Potential infectivity of oral tissues in CJD or vCJD patients is an unresolved issue. Scientific data indicate the risk, if any, of sporadic CJD transmission during dental and oral surgical procedures is low to nil. Until additional information exists regarding the transmissibility of CJD or vCJD during dental procedures, special precautions in addition to standard precautions might be indicated when treating known CJD or vCJD patients; a list of such precautions is provided for consideration without recommendation (see *Special Considerations: Creutzfeldt-Jakob Disease and Other Prion Diseases*) (Unresolved issue).

M. Program Evaluation

1. Establish routine evaluation of the infection control program, including evaluation of performance indicators, at an established frequency (II) (470-471).

HOW TO LEARN MORE

The ADA has posted on its website a “roadmap” to help dental health professionals navigate through the CDC guidelines and put the recommendations into practice. This roadmap (available at <http://www.ada.org/prof/resources/topics/cdc/index.asp>) provides a general overview of the guidelines and the major subjects covered and offers links to existing information about them.

This is an evolving document. Regular additions and updates will provide the information needed to understand and implement the new guidelines. Questions should be directed to the ADA Division of Science at 800-621-8099, extension 2878, or at science@ada.org.

Additional information on products and services for dental unit waterline cleaning and monitoring is available at <http://www.ada.org> or from the ADA Division of Science, telephone: 800-621-8099, extension 2878, or e-mail: science@ada.org.

REFERENCES

1. Centers for Disease Control and Prevention, Division of Oral Health, Infection Control in Dental Settings (website), <http://www.cdc.gov/oralhealth/infectioncontrol/index.html>; Accessed 1 November 2016.
2. Centers for Disease Control and Prevention, Division of Oral Health, Infection Control in Dental Settings: Prevention of 2009 H1N1 influenza transmission in dental health care settings (article online), http://www.cdc.gov/OralHealth/infectioncontrol/factsheets/2009_h1n1.htm; Accessed 1 November 2016.
3. Centers for Disease Control and Prevention: Seasonal flu: respiratory hygiene/cough etiquette in healthcare settings (article online), www.cdc.gov/flu/professionals/

- [infectioncontrol/resphygiene.htm](#); Accessed 1 November 2016.
4. Cleveland JL, Robison VA, Panlilio AL. Tuberculosis epidemiology, diagnosis and infection control recommendations for dental settings: an update on the Centers for Disease Control and Prevention guidelines. *J Am Dent Assoc.* 2009;140:1092-1099.
 5. Jensen PA, et al. Guidelines for preventing the transmission of *Mycobacterium tuberculosis* in health-care settings, 2005. *MMWR Recomm Rep.* 2005;54(RR-17):1-142.
 6. Centers for Disease Control and Prevention. Guidelines for infection control in dental health-care settings—2003. *MMWR Morb Mortal Wkly Rep.* 2003;52(RR-17):1-66. [Medline].
 7. Centers for Disease Control and Prevention. Recommended infection control practices for dentistry, 1993. *MMWR Morb Mortal Wkly Rep.* 1993;41(RR-8):1-12.
 8. U.S. Census Bureau: 2001 statistical abstract of the United States: section 12—labor force, employment, and earnings (article online), www.census.gov/prod/2002pubs/01statab/labor.pdf; Accessed 1 November 2016.
 9. Centers for Disease Control and Prevention. Recommended infection control practices for dentistry. *MMWR Morb Mortal Wkly Rep.* 1986;35:237-242.
 10. The control of transmissible disease in dental practice: a position paper of the American Association of Public Health Dentistry. *J Public Health Dent.* 1986;46:13-22.
 11. Health Resources and Services Administration. U.S. *Health Workforce Personnel Factbook.* Rockville, MD: Health Resources and Services Administration; 2000.
 12. Klein RS, et al. Low occupational risk of human immunodeficiency virus infection among dental professionals. *N Engl J Med.* 1988;318:86-90.
 13. Ciesielski C, et al. Transmission of human immunodeficiency virus in a dental practice. *Ann Intern Med.* 1992;116:798-805.
 14. Centers for Disease Control and Prevention. Epidemiologic notes and reports update: transmission of HIV infection during invasive dental procedures—Florida. *MMWR Morb Mortal Wkly Rep.* 1991;40:377-381.
 15. U.S. Department of Labor, Occupational Safety and Health Administration. 29 CFR Part 1910: occupational exposure to blood-borne pathogens; needlestick and other sharps injuries; final rule. *Fed Reg.* 2001;66:5317-5325. available at: www.osha.gov/FedReg_oshapdf/FED20010118A.pdf. Accessed 1 November 2016.

Therapeutic Management of Common Oral Lesions

This appendix is provided for clinicians as a guide to the management of oral lesions that may be commonly encountered in the dental practice. It is intended only as a reference and is based on correct diagnosis of the condition and background knowledge of how the recommended therapies can be properly used. This information also is provided as a courtesy of the American Academy of Oral Medicine (AAOM), which publishes a guide for clinicians (Siegel M, Silverman S, Sollecito T: *Clinician's guide: treatment of common oral lesions*, Hamilton, Ontario, Canada, BC Decker, 2006) that contains much of this same information. We (all members of the AAOM) acknowledge our deep appreciation for the authorization to publish this appendix.

This appendix is intended as a quick reference to the causative factors, clinical description, currently accepted therapeutic management, and patient education regarding the more common oral conditions. Some of the recommended treatments have been more thoroughly investigated than others, but all have been reported to be of clinical value.

No cure has been found for many of the oral conditions described here, but treatment modalities are available that can relieve discomfort, shorten clinical duration and frequency, and minimize recurrences.

Clinicians are reminded that an accurate diagnosis is imperative for clinical success. Every effort should be made to determine the diagnosis before treatment is initiated. Infection and malignancy must be ruled out. When signs and symptoms and microscopic and other laboratory evidence do not support a definitive diagnosis, empirical treatment may be initiated and evaluated on a therapeutic trial basis.

Patient management should be governed by the natural history of the oral condition and whether a palliative, supportive, or curative treatment exists. Appropriate referral is indicated when the clinical problem is beyond the scope of the clinician's practice. Further treatment can be determined by the patient's response. However, when healing of a lesion or an expected response to treatment is not attained within an expected length of time, biopsy is recommended.

Unless otherwise specified as over-the-counter (OTC) drugs, all therapeutic agents recommended for treatment

of specific lesions and conditions are prescription drugs; particulars of the prescription (Rx) are given for each such agent. Of note, the U.S. Food and Drug Administration (FDA) has been active in recent years in allowing OTC status for drugs formerly available by prescription only. It is important to check the dosages of newly released OTC drugs because they usually differ in strength from agents available by prescription.

SUPPORTIVE CARE

Management of oral mucosal conditions may require topical and systemic interventions. Therapy should address patient nutrition and hydration, oral discomfort, oral hygiene, management of secondary infection, and local control of the disease process. Depending on the extent, severity, and location of oral lesions, consideration should be given to obtaining a consultation from a dentist who specializes in oral medicine, oral pathology, or oral surgery. When a question arises involving a medical condition, a physician should be consulted.

Symptomatic relief of painful conditions can be provided with topical preparations such as 2% viscous lidocaine hydrochloride or 0.5% dyclonine hydrochloride. Topical anesthetic may be used as a rinse in adults but should be applied with a cotton swab in children so they do not swallow the medication. Swallowing these anesthetics is contraindicated, in part because they may interfere with the patient's gag reflex. Symptomatic relief also can be attained by mixing equal parts of diphenhydramine hydrochloride elixir and magnesium hydroxide or aluminum hydroxide. Children's formula diphenhydramine hydrochloride elixir does not contain alcohol. Sucralfate suspension also may be used before meals. The diphenhydramine mixture and the sucralfate coat the ulcerated lesions, allowing the patient to eat more comfortably.

Meticulous oral hygiene is absolutely mandatory for these patients. Mucosal lesions that contact bacterial plaque present on the dentition are more likely to become secondarily infected. Patients should be seen by a dentist or the hygienist for scaling and root planing, with use of local anesthesia when necessary, in all cases in which oral hygiene is suboptimal. Patients must be encouraged to brush and floss their teeth after meals in a gentle yet

efficient manner. This practice may be enhanced by use of a soft toothbrush that has been soaked briefly in hot water to further soften the bristles. Tartar control toothpastes that contain calcium pyrophosphate should be avoided because of their caustic nature and reported association with circumoral dermatitis.

HERPES SIMPLEX

Infection with the herpes simplex virus produces a disease that has a primary, or acute, phase and a secondary, or recurrent, phase.

PRIMARY HERPETIC GINGIVOSTOMATITIS

Etiology

A transmissible infection with herpes simplex virus, usually type I, less commonly type II.

Clinical Description

Clear, then yellowish vesicles develop intraorally and extraorally. These vesicles rupture within hours to form shallow, painful ulcers. Gingivae often are red, enlarged, and painful. The patient may have systemic signs and symptoms, including regional lymphadenitis, fever, and malaise. Usually, the eruption is self-limiting and heals in 7 to 10 days.

Rationale for Treatment

Relieve symptoms, prevent secondary infection, and support general health. Supportive therapy includes forced fluids, protein, vitamin and mineral food supplements, and rest. Systemic acyclovir is effective in treating herpes in immunocompromised patients. Topical steroids should be avoided because they tend to permit spread of the viral infection on mucous membranes, particularly ocular membranes. Patients should be cautioned to avoid touching the herpetic lesions and then touching the eyes, genitals, or other body areas because of the possibility of self-inoculation.

Topical Anesthetics and Coating Agents

Rx:

Diphenhydramine (Benadryl) elixir 12.5 mg/5 mL
(NOTE: elixir is Rx, and syrup [Benylin] is OTC)
4 oz, mixed with Kaopectate (OTC) 4 oz, to make
a 50% mixture by volume

Disp: 8 oz

Sig: Rinse with 1 teaspoonful every 2 hours and spit out.
Maalox OTC can be used in place of Kaopectate.

Dyclonine (Dyclone) HCl 0.5%, 1 oz, may be added for greater anesthetic efficacy.

Rx:

Diphenhydramine (Benadryl) elixir 12.5 mg/5 mL
(NOTE: elixir is Rx, and syrup [Benylin] is OTC)

Disp: 4-oz bottle

Sig: Rinse with 1 teaspoonful for 2 minutes, every 2 hours and before each meal and spit out.

NOTE: This preparation can be mixed with 2% viscous lidocaine or dyclonine 0.5% for additional relief.

Rx:

Lidocaine (viscous) 2.0% or 1%

Disp: 1-oz bottle

Sig: Rinse with 1 teaspoonful for 2 minutes before each meal and spit out.

Rx:

Dyclonine HCl (Dyclone) 0.5% or 1%

Disp: 1-oz bottle

Sig: Rinse with 1 teaspoonful for 2 minutes before each meal and spit out.

Systemic Antiviral Therapy. Antiviral agent oral capsules may relieve and decrease the duration of symptoms.

Rx:

Acyclovir (Zovirax) capsules 200 mg

Disp: 50 (or 60) capsules

Sig: Take 1 capsule five times a day for 10 days (or 2 capsules three times a day for 10 days).

(Current FDA recommendation is that systemic acyclovir should be used to treat oral herpes only in immunocompromised patients.)

Rx:

Valacyclovir (Valtrex) caplets 500 mg

Disp: 20 caplets

Sig: Take 2 caplets twice a day for 5 days.

(This regimen is that currently recommended by the Centers for Disease Control and Prevention [CDC] for management of genital herpes.)

Systemic Antibiotics. (For secondary bacterial infection in susceptible patients; not for routine use.)

Rx:

Penicillin V tablets 500 mg

Disp: 40 tablets

Sig: Take 1 tablet four times a day.

For patients allergic to penicillin:

Rx:

Erythromycin tablets 250 mg

Disp: 40 tablets

Sig: Take 1 tablet four times a day.

If nausea or stomach cramps occur, prescribe enteric-coated preparations (e.g., E-Mycin, ERYC, PCE) or a second-generation erythromycin (e.g., clarithromycin [Biaxin]).

Nutritional Supplements

Rx:

Meritene—protein, vitamin, and mineral food supplement (OTC)

Disp: 1-lb can (plain vanilla, chocolate, and eggnog flavors)

Sig: Take 3 servings daily. Prepare as indicated on the label. Serve cold.

Rx:

Ensure Plus—protein, vitamin, and mineral food supplement (OTC)

Disp: 20 cans

Sig: Drink 3 to 5 cans in divided doses throughout the day as tolerated. Serve cold.

Analgesic

Rx:

Acetaminophen tablets 325 mg (OTC)

Sig: Take 2 tablets every 4 hours as needed for pain and fever. Limit 4 g per 24 hours.

For moderate to severe pain:

Acetaminophen 300 mg with codeine 30 mg (Tylenol #3)

Sig: Take 1 or 2 tablets every 4 hours for pain (requires Drug Enforcement Agency [DEA] number).

RECURRENT (OROFACIAL) HERPES SIMPLEX

Etiology

Reactivation of the latent virus that resides in the sensory ganglion of the trigeminal nerve. Precipitating factors include fever, stress, exposure to sunlight, trauma, and hormonal alterations.

Clinical Description

Intraoral—single or small clusters of vesicles that quickly rupture, forming painful ulcers. Lesions usually occur on the keratinized tissue of the hard palate and gingiva.

Labialis—clusters of vesicles on the lips that rupture within hours and then crust.

Rationale for Treatment

Treatment should be initiated as early as possible during the prodromal stage, with the objective of reducing duration and symptoms of the lesion. Oral acyclovir, given prophylactically and therapeutically, may be considered when frequent recurrent herpetic episodes interfere with daily function and nutrition.

(Current FDA recommendation is that systemic acyclovir should be used to treat oral herpes only in immunocompromised patients.)

Prevention

Rx:

PreSun 15 sunscreen lotion (OTC)

Disp: 4 fl oz

Sig: Apply to susceptible area 1 hour before sun exposure and every hour thereafter.

Rx:

PreSun 15 lip gel (OTC)

Disp: 15 oz

Sig: Apply to lips 1 hour before sun exposure and every hour thereafter.

If recurrence on the lips usually is precipitated by exposure to sunlight, the lesion may be prevented by the application to the area of a sunscreen with a high sunburn protection factor (SPF 15 or higher).

Topical Antiviral Agents. Antiviral creams and ointments are of minimal efficacy for recurrent herpes simplex. Their value may be attributable to coating of the lesion by the

petrolatum vehicle, which reduces the possibility of self-inoculation. Constant or intermittent application of ice to the area for 90 minutes during the prodromal phase may result in abortion of the lesion. Cocoa butter ointment, lanolin-based lip preparations, or petrolatum (Vaseline) as an emollient may be palliative.

Rx:

Penciclovir (Denavir) topical ointment 5%

Disp: 15-g tube

Sig: Apply to the area every 2 hours during waking hours, beginning when symptoms first occur.

Rx:

Docosanol (Abreva) cream (OTC)

Disp: 2-g tube

Sig: Dab on lesion five times per day during waking hours for 4 days, beginning when symptoms first occur.

Systemic Antiviral Therapy. This is best implemented at the very onset of prodromal symptoms.

Rx:

Valacyclovir (Valtrex) caplets 500 mg

Disp: 8 caplets

Sig: Take 4 caplets at the very beginning of prodromal symptoms and 4 caplets 12 hours later.

VARICELLA ZOSTER (SHINGLES)

Etiology

Reactivation of latent herpesvirus–varicella virus present since an original varicella virus infection, typically chickenpox. Precipitating factors include thermal, inflammatory, radiologic, and mechanical trauma.

Clinical Description

Usually painful, segmental eruption of small vesicles that later rupture to form punctate or confluent ulcers. Acute zoster follows a portion of the trigeminal nerve distribution in approximately 20% of cases. It is rare in the young and more common in older adults.

Rationale for Treatment

Promptly initiate antiviral therapy to reduce the duration and symptoms of lesions. Patients older than 60 years of age are particularly prone to postherpetic neuralgia. In the absence of specific contraindications, consideration should be given to prescribing short-term, high-dose corticosteroid prophylaxis for postherpetic neuralgia, in conjunction with oral acyclovir.

Rx:

Acyclovir (Zovirax) capsules 200 mg

Disp: 200 capsules

Sig: Take 4 capsules five times daily for 10 days.

Rx:

Valacyclovir (Valtrex) HCl caplets 500 mg

Disp: 42 capsules

Sig: Take 2 capsules three times daily for 7 days.

Use with caution in immunocompromised patients.

Rx:

Prednisone tablets 10 mg

Disp: 50 tablets

Sig: Take 6 tablets in the morning; then reduce the number by 1 on each successive day.

RECURRENT APHTHOUS STOMATITIS

Etiology

An altered local immune response is the predisposing factor. Patients with frequent recurrences should be screened for disease such as anemia, diabetes mellitus, vitamin deficiency, inflammatory bowel disease, and immunosuppression.

Precipitating factors include stress, trauma, allergies, endocrine alterations, and dietary components such as acidic foods and juices and foods that contain gluten. Inspect the oral cavity closely for sources of trauma.

Clinical Description

Minor aphthae (canker sore), smaller than 0.6 cm—small, shallow, painful ulcerations covered by a gray membrane and surrounded by a narrow erythematous halo. They usually occur on nonkeratinized (movable) oral mucosa.

Major aphthae, greater than 0.6 cm—large, painful ulcers. A more severe form of aphthae that may last weeks or months. They may mimic other diseases such as granulomatous or malignant lesions.

Herpetiform ulcers—crops of small, shallow, painful ulcers. They may occur anywhere on nonkeratinized oral mucosa and resemble those of recurrent intraoral herpes simplex clinically but are of unknown origin.

Rationale for Treatment

Effective treatment involves barriers, amlexanox, topical or systemic corticosteroids, and immunosuppressants or combination therapy, when indicated. Treatment should be initiated as early in the course of the lesions as possible. Identification and elimination of precipitating factors may serve to minimize recurrent episodes. Medications such as mycophenolate mofetil, pentoxifylline, and thalidomide are useful for treating patients with severe, persistent recurrent aphthous ulcers but should not be routinely used.

Nonsteroidal Agents

Rx:

Amlexanox oral paste 5%

Disp: 5-g tube

Sig: Dab on affected area four times a day until healed.

Rx:

Orabase Soothe-N-Seal Protective Barrier (OTC)

Disp: 1 package

Sig: Apply according to the package directions every 6 hours, when necessary.

For mild to moderate relief:

“Special Mouthwash.”* There is no “universal formula” for this preparation. Any of several variations can be concocted, depending on the diagnosis and the patient’s symptoms. The Special Mouthwash must be made up for each individual patient.

Basic (OTC):

Benadryl	+	Carafate	+	Maalox elixir
160 mL		40 mL		40 mL

Optional:

± Kaopectate (OTC)

± nystatin

± anesthetic (Dyclone, lidocaine)

± antibiotic (tetracycline, penicillin)

For example, for *glossitis, aphthous, mild lichen planus:*

Special Mouthwash Rx:

Guaifenesin	80 mL
Diphenhydramine (12.5/5 cc)	200 mL
Nystatin (100,000 IU/5 cc)	30 mL
Sucralfate	100 mL
Maalox	50 mL
2% viscous lidocaine	20 mL

Disp: 480 mL

Sig: Take 3 tsp (15 mL), swish for 3 minutes, gargle, and expectorate three times a day for 2 weeks; then use daily as needed for maintenance.

Topical Steroids. Therapies with steroids and immunomodulating drugs are presented to inform the clinician that such modalities are available. Because of the potential for adverse effects, close collaboration with the patient’s physician is recommended when these medications are prescribed. These modalities may be beyond the scope of clinical experience of general dentists, and referral to a specialist in oral medicine or to an appropriate physician may be necessary.

Prolonged use of topical steroids (>2 weeks of continuous use) may result in mucosal atrophy or secondary candidiasis and may increase the potential for systemic absorption. It may be necessary to prescribe antifungal therapy concomitantly with steroids.

Rx:

Triamcinolone acetonide (Kenalog) in Orabase 0.1%

Disp: 5-g tube

Sig: Coat the lesion with a thin film after each meal and at bedtime.

Other topical steroid preparations (cream, gel rinse, ointment) include the following:

Ultrapotent

- Clobetasol propionate (Temovate) 0.05%

- Halobetasol propionate (Ultravate) 0.05%

Potent

- Dexamethasone (Decadron) 0.5 mg/5 mL

*The Special Mouthwash is being considered for patent by the University of Minnesota under the name Rhodus Magical Mouthwash

Intermediate

- Betamethasone valerate (Valisone) 0.1%
- Triamcinolone acetonide (Kenalog) 0.1%

Low

- Hydrocortisone 1%

NOTE: Mixing ointments with equal parts of Orabase B paste promotes adhesion. Also, mixing with 2% lidocaine gel will help palliate symptoms.

Rx:

Dexamethasone (Decadron) elixir 0.5 mg/5 mL

Disp: 100 mL

Sig: Rinse with 1 teaspoon for 2 minutes four times a day and expectorate. Discontinue when lesions become asymptomatic.

Some clinicians have had increased success by combining both topical rinses (dexamethasone) and ointments (triamcinolone) and using them concomitantly for more severe cases.

Oral candidiasis may result from topical steroid therapy. The oral cavity should be monitored for emergence of fungal infection in patients who are placed on therapy. Prophylactic antifungal therapy should be initiated in patients with a history of fungal infection with previous steroid administration (see “Candidiasis”).

System Steroids and Immunosuppressants

For severe cases:

Rx:

Dexamethasone (Decadron) elixir 0.5 mg/5 mL

Disp: 320 mL

Sig:

1. For 3 days, rinse with 1 tablespoon (15 mL) four times a day and swallow. Then:
2. For 3 days, rinse with 1 teaspoonful (5 mL) four times a day and swallow. Then:
3. For 3 days, rinse with 1 teaspoonful (5 mL) four times a day and swallow every other time. Then:
4. Rinse with 1 teaspoonful (5 mL) four times a day and spit out. Discontinue medication when mouth becomes comfortable.

If mouth discomfort recurs, restart treatment at step 3. Rinsing should be done after meals and at bedtime. Refill once.

Rx:

Prednisone tablets 5 mg

Disp: 40 tablets

Sig: Take 5 tablets in the morning for 5 days; then take 5 tablets in the morning every other day until gone.

For very severe cases:

Rx:

Prednisone tablets 10 mg

Disp: 26 tablets

Sig: Take 4 tablets in the morning for 5 days; then decrease by 1 tablet on each successive day.

Therapy with medications such as systemic steroids, immunosuppressants, and immunomodulators is presented

to inform the clinician that such modalities have been reported to be effective for patients with severe, persistent, recurrent aphthous stomatitis. Medications such as azathioprine, pentoxifylline, levamisole, colchicine, dapsone, and thalidomide are used to treat patients with severe, persistent, recurrent aphthous stomatitis but should not be routinely used because of the potential for adverse effects. Close collaboration with the patient's physician is recommended when these medications are prescribed.

CHEMICAL CAUTERY

In some instances, instant cautery of the ulcer, although it is temporarily painful, diminishes overall symptoms and eliminates the ulcer. The procedure involves professional application of an appropriate agent.

Rx:

Debacterol: One clinical application directly to the ulcer for 15 seconds; then rinse thoroughly.

Phased Therapy. In many cases of these oral erosive-ulcerative conditions (e.g., recurrent aphthous stomatitis, oral lichen planus), the therapy will only temporarily ameliorate the condition. Because the condition will remain (although less acute) or return over time, the clinician may choose to place the patient on a maintenance or less potent treatment during the remission (or less acute phase), thereby reducing the frequency and severity of flares.

CANDIDIASIS**Etiology**

Candida albicans, a yeast-like fungus, is the infecting pathogen. *Candida* is an opportunistic organism that tends to proliferate with the use of broad-spectrum antibiotics, corticosteroids, medicines that reduce salivary output, and cytotoxic agents. Conditions that contribute to candidiasis include xerostomia, diabetes mellitus, poor oral hygiene, prosthetic appliances, and suppression of the immune system (e.g., acquired immunodeficiency syndrome [AIDS] or the adverse effects of some medications). It is important to ascertain the predisposing factors.

Clinical Description

The disease is characterized by soft, white, slightly elevated plaques that usually can be wiped away, leaving an erythematous area (pseudomembranous type). Candidiasis also may appear as generalized erythematous, sensitive areas (atrophic or erythematous type) or as confluent white areas (hypertrophic form). When the clinical diagnosis is questionable, it is advisable to culture for *C. albicans* concurrent with the start of medication.

Rationale for Treatment

To reestablish a normal balance of oral flora and to improve oral hygiene. Medication should be continued for 48 hours after clinical signs have disappeared to prevent immediate recurrence.

Topical Antifungal Agents

Rx:

Nystatin (Mycostatin, Nilstat) oral suspension 100,000 units/mL

Disp: 60 mL

Sig: Take 2 to 5 mL four times a day. Rinse for 2 minutes and swallow. Nystatin suspension has a high sugar content; therefore, good oral hygiene should be reinforced. A few drops of nystatin oral suspension can be added to the water used for soaking acrylic prostheses.

Rx:

Nystatin ointment

Disp: 15-g tube

Sig: Apply a thin coat to the inner surface of the denture and to the affected area after each meal.

Rx:

Nystatin topical powder

Disp: 15 g

Sig: Apply a thin layer under the prosthesis after each meal.

Rx:

Nystatin pastilles (Mycostatin) 200,000 U

Disp: 50 pastilles

Sig: Let 1 pastille dissolve in the mouth five times a day.

Rx:

Nystatin vaginal suppositories 100,000 U

Disp: 40 suppositories

Sig: Let 1 suppository dissolve in the mouth four times a day. Do not rinse for 30 minutes.

Rx:

Clotrimazole (Mycelex) troches 10 mg

Disp: 70 troches

Sig: Let 1 troche dissolve in the mouth five times a day. If concern is expressed about the sugar content of nystatin and clotrimazole troches, vaginal tablets may be substituted.

Rx:

Ketoconazole (Nizoral) cream 2%

Disp: 15-g tube

Sig: Apply thin coat to inner surface of denture and affected areas after each meal.

Rx:

Clotrimazole (Gyne-Lotrimin, Mycelex-G) vaginal cream 1% (OTC)

Disp: 1 tube

Sig: Apply a small dab to tissue side of denture or to infected oral mucosa four times a day.

Rx:

Miconazole (Monistat 7) vaginal cream 2% (OTC)

Disp: 1 tube

Sig: Apply small dab to tissue side of denture or to infected oral mucosa four times a day.

NOTE: In many cases, combinations of these antifungal preparations (liquids, troches, and ointments) may be used, depending on clinical considerations and response to therapy. Because patients presenting with candidiasis often have an underlying condition predisposing them to the disease (e.g., immunosuppression, xerostomia), it is important to keep in mind that as long as the predisposing condition is present, the candidiasis will persist or recur despite periodic treatment with these agents. Therefore, the clinician must consider removal of the etiologic factors, place the patient on maintenance therapy for recurrent candidiasis, or both.

Systemic Antifungal Agents. When topical therapy is not practical or is ineffective, ketoconazole (Nizoral) and fluconazole (Diflucan) are effective, well-tolerated, systemic drugs for mucocutaneous candidiasis. They should be used with caution in patients with impaired liver function (i.e., with a history of alcoholism or hepatitis). Liver function tests should be performed initially and then monthly when ketoconazole is prescribed for an extended period. Several drug interactions have been reported with ketoconazole.

Rx:

Ketoconazole (Nizoral) tablets 200 mg

Disp: 20 tablets

Sig: Take 1 tablet daily with a meal or with orange juice.

Rx:

Fluconazole (Diflucan) tablets 100 mg

Disp: 20 tablets

Sig: Take 2 tablets stat and then 1 tablet daily.

NOTE: Because patients often are susceptible to recurring *Candida* infection, some “burst” therapy with systemic or topical antifungals (or both) may be necessary, as well as ongoing maintenance therapy.

CHEILITIS AND CHEILOSI

ANGULAR CHEILITIS AND CHEILOSI

Etiology

Fissured lesions in the corners of the mouth are caused by a mixed infection of the microorganisms *C. albicans*, staphylococci, and streptococci. Predisposing factors include local habits, drooling, a decrease in intermaxillary space, anemia, immunosuppression, and extension of oral infection.

Clinical Description

Commissures may appear wrinkled, red, fissured, cracked, or crusted.

Rationale for Treatment

Identification and correction of predisposing factors and elimination of secondary infection and inflammation

Rx:

Nystatin plus triamcinolone acetonide (Mycolog II) ointment

Disp: 15-g tube

Sig: Apply to affected area after each meal and at bedtime. Concomitant intraoral antifungal treatment may be indicated.

Rx:

Ketoconazole (Nizoral) cream 2%

Disp: 15-g tube

Sig: Apply a small dab to corners of mouth daily at bedtime.

Rx:

Clotrimazole (Gyne-Lotrimin, Mycelex-G) vaginal cream 1% (OTC)

Disp: 1 tube

Sig: Apply small dab to corner of mouth four times a day.

Rx:

Miconazole (Monistat 7) nitrate vaginal cream 2% (OTC)

Disp: 1 tube

Sig: Apply a small dab to corner of mouth four times a day.

ACTINIC CHEILITIS AND SOLAR CHEILOSIS

Etiology

Prolonged exposure to sunlight results in irreversible degenerative changes in the vermilion of the lips, especially the everted lower lip.

Clinical Description

Normal red translucent vermilion with regular vertical fissuring of a smooth surface is replaced by a white flat surface that may exhibit periodic ulceration.

Rationale for Treatment

If exposure to ultraviolet light in the sun's rays is allowed to continue, degenerative changes may progress to malignancy. Sunscreens with a high SPF (>15) should be used constantly.

Rx: Several OTC sunscreen preparations are available (e.g., PreSun 15 lotion and lip gel). For patients who are allergic to para-aminobenzoic acid, non-para-aminobenzoic acid sunscreens should be prescribed.

GEOGRAPHIC TONGUE (BENIGN MIGRATORY GLOSSITIS; ERYTHEMA MIGRANS)

Etiology

The cause of geographic tongue is unknown. Because the histologic appearance is similar to that of psoriasis, some investigators have associated it with psoriasis. This association may be purely coincidental. Oral lesions should not be attributed to psoriasis if no cutaneous signs of this

disorder are evident. It also has been associated with Reiter syndrome and atopy.

Clinical Description

This is a benign inflammatory condition caused by desquamation of superficial keratin and filiform papillae. It is characterized by red, denuded, irregularly shaped patches of the tongue dorsum and lateral borders surrounded by a raised white-yellow border.

Rationale for Treatment

Generally, no treatment is necessary because most patients are asymptomatic. When symptoms are present, they may be associated with secondary infection with *C. albicans* (see earlier under "Supportive Care"). Use of topical steroids, especially in combination with topical antifungal agents, is the treatment modality of choice. Patients must be educated regarding this condition and reassured that it does not indicate a more serious disease and that it is not contagious. In most cases, biopsy is not indicated because of the pathognomonic clinical appearance.

Rx:

Nystatin-triamcinolone acetonide (Mycolog II, Mytrex) ointment

Disp: 15-g tube

Sig: Apply to affected areas after meals and at bedtime.

Rx:

Clotrimazole-betamethasone dipropionate (Lotrisone) cream

Disp: 15-g tube

Sig: Apply to affected area after each meal and at bedtime.

Rx:

Betamethasone valerate ointment 0.1%

Disp: 15-g tube

Sig: Apply to affected areas after meals and at bedtime.

Rx:

Nystatin ointment

Disp: 15-g tube

Sig: Apply to affected areas after meals and at bedtime.

For mild to moderate relief:

"Special Mouthwash"

Rx: Refer to earlier section, "Recurrent Aphthous Stomatitis," for formulation.

XEROSTOMIA

Etiology

Acute or chronic reduced salivary flow may result from drug therapy, mechanical blockage, dehydration, emotional stress, infection of the salivary glands, local surgery, avitaminosis, diabetes, anemia, connective tissue disease, Sjögren syndrome, radiation therapy, and congenital factors (e.g., ectodermal dysplasia) (see Chapter 25).

Clinical Description

Tissues may be dry, pale, or red and atrophic. The tongue may be devoid of papillae and may be atrophic, fissured, and inflamed. Multiple carious lesions may be present, especially at the gingival margin and on exposed root surfaces.

Rationale for Treatment

Salivary stimulation or replacement therapy to keep the mouth moist, prevent caries and candidal infection, and provide palliative relief

Saliva Substitutes

Rx:

Sodium carboxymethyl cellulose 0.5% aqueous solution (OTC)

Disp: 8 fl oz

Sig: Use as a rinse as frequently as needed.

Saliva substitutes (OTC): Oasis, MouthKote, Sage Moist Plus, Xero-Lube, MedOral, Salivart, Moi-Stir, Orex

Commercial oral moisturizing gels (OTC): Sage Mouth Moisturizer, Oral Balance

Relief from oral dryness and accompanying discomfort may be attained conservatively by sipping water frequently all day long, letting ice melt in the mouth, restricting caffeine intake, not using mouth rinses that contain alcohol, humidifying the sleeping area, and coating lips with Blistex or Vaseline.

Saliva Stimulants. Chewing sugarless gum and sucking sugarless mints are conservative ways to temporarily stimulate salivary flow in patients with medication xerostomia or with salivary gland dysfunction. Patients should be cautioned against using products that contain sugar.

Rx:

Pilocarpine HCl solution 1 mg/mL

Disp: 100 mL

Sig: Take 1 teaspoonful four times a day. (Dosage should be adjusted to increase saliva while minimizing adverse effects [sweating, stomach upset].)

Rx:

Pilocarpine HCl 5-mg tablets (Salagen)

Disp: 100 tablets

Sig: Take 1 tablet three times a day. An extra tablet (10 mg) may be taken at bedtime.

Rx:

Cevimeline HCl (Evoxac) 30-mg tablets

Disp: 100 tablets

Sig: Take 1 tablet by mouth 3 or three times a day.

Rx:

Bethanechol (Urecholine) 25 mg

Disp: 21 tablets

Sig: Take 1 tablet three times a day.

Caries Prevention. Patients with hyposalivation are at significantly increased risk for development of caries, so an aggressive plan for prevention must be instituted as soon as possible. Frequent profession visits and prophylaxis

are important, as is the application of fluoride varnishes.

Rx:

Stannous fluoride gel 0.4%

Disp: 4.3 oz

Sig: Apply to the teeth daily for 5 minutes; 5 to 10 drops in a custom tray. Do not swallow the gel.

Available stannous fluoride gels include IDP Gel-Oh, Stan-Gard, Perfect Choice, Flo Gel, True Gel, Nova Gel, Omni-Gel, Control, Gel-Pro, Perfect Choice, Basic Gel, Gel-Tin, IDP Gel-Oh, Gel-Kam, Stan-Gard, Easy-Gel, and Thera-Flur.

When the taste of acidulated stannous fluoride gels is poorly tolerated or when etching of ceramic restorations occurs, neutral pH sodium fluoride gel 1% (Thera-Flur-N) should be considered.

Rx:

Neutral NaF gel (Thera-Flur-N) 1.0% or PreviDent (Colgate) 1.1% neutral NaF

Disp: 24 mL

Sig: Place 1 drop per tooth in custom tray; apply for 5 minutes daily. Avoid rinsing or eating for 30 minutes after treatment.

Food and Drug Administration regulations have limited the size of bottles of fluoride because of toxicity if ingested by infants. Because most preparations do not come in childproof bottles, the sizes of topical fluoride preparations vary; 24 mL is approximately a 2-week supply for application to full dentition in custom carriers. Xerostomia provides an excellent environment for overgrowth of *C. albicans*. The patient is likely to require treatment for candidiasis, along with treatment for dry mouth. In a dry oral environment, plaque control becomes more difficult. Scrupulous oral hygiene is essential.

ORAL LICHEN PLANUS

Etiology

Postulated to be a chronic mucocutaneous autoimmune disorder with a genetic predisposition that is initiated by a variety of factors, including emotional stress, hypersensitivity to drugs, dental products, or foods.

Clinical Description

Oral lichen planus varies in clinical appearance. Oral forms of this disorder include lacy white lines that represent Wickham's striae (reticular), an erythematous form (atrophic), and an ulcerating form that often is accompanied by striae peripheral to the ulceration (ulcerative).

Lesions are commonly found on the buccal mucosa, gingiva, and tongue but may be found on the lips and palate. Lichen planus lesions are chronic and also may affect the skin.

Any refractory lesion should be considered for a biopsy to establish a diagnosis and to rule out a malignancy.

Rationale for Treatment

To provide oral comfort if lesions are symptomatic. No known cure exists. Systemic and local relief with anti-inflammatory and immunosuppressant agents is indicated. Identification of any precipitating dietary component, dental product, or medication (lichenoid drug reaction) should be undertaken to ensure against a hypersensitivity reaction. Treatment or prevention of secondary fungal infection with a systemic antifungal agent also should be considered.

Therapies with steroids and immunomodulating drugs are presented to inform the clinician that such modalities are available. Because of the potential for adverse effects, close collaboration with the patient's physician is recommended when these medications are prescribed. These modalities may be beyond the scope of clinical experience of general dentists, and referral to a specialist in oral medicine or to an appropriate physician may be necessary.

Topical Steroids. Prolonged use of topical steroids (for a period of longer than 2 weeks of continuous use) may result in mucosal atrophy and secondary candidiasis and may increase the potential for systemic absorption. The prescribing of antifungal therapy with steroids may be necessary. Therapy with topical steroids, when lichen planus is under control, should be tapered to alternate-day therapy, or treatment given less often, depending on level of control of the disease and its tendency to recur.

Rx:

Fluocinonide (Lidex) gel 0.05%

Disp: 30-g tube

Sig: Coat the lesion with a thin film after each meal and at bedtime.

Rx:

Dexamethasone (Decadron) elixir 0.5 mg/5 mL

Disp: 100 mL

Sig: Rinse with 1 teaspoonful for 2 minutes four times a day and spit out. Discontinue when lesions become asymptomatic.

Other topical steroid preparations (cream, gel, ointment) include the following:

Ultrapotent

- Clobetasol propionate (Temovate) 0.05%
- Halobetasol propionate (Ultravate) 0.05%

Potent

- Dexamethasone (Decadron) 0.5 mg/5 mL
- Fluocinonide (Lidex) 0.05%
- Fluticasone propionate (Cutivate) 0.05%

Intermediate

- Betamethasone valerate (Valisone) 0.1%
- Alclometasone dipropionate (Aclovate) 0.05%
- Triamcinolone acetonide (Kenalog) 0.1%

Low

- Hydrocortisone 1%

Oral candidiasis may result from topical steroid therapy. The oral cavity should be monitored for emergence of

fungal infection in patients who are placed on therapy. Prophylactic antifungal therapy should be initiated in patients with a history of fungal infection with prior steroid administration (see "Candidiasis").

Systemic Steroids and Immunosuppressants

For severe cases:

Rx:

Medrol Dose Pak

Disp: 1 dose pack

Sig: Follow directions on dose pack for number of tablets to take each day.

Rx:

Dexamethasone (Decadron) elixir 0.5 mg/5 mL

Disp: 320 mL

Sig:

1. For 3 days, rinse with 1 tablespoonful (15 mL) four times a day and swallow. Then:
2. For 3 days, rinse with 1 teaspoonful (5 mL) four times a day and swallow. Then:
3. For 3 days, rinse with 1 teaspoonful (5 mL) four times a day and swallow every other time. Then,
4. Rinse with 1 teaspoonful (5 mL) four times a day and expectorate.

Rx:

Prednisone tablets 10 mg

Disp: 26 tablets

Sig: Take 4 tablets in the morning for 5 days; then decrease by 1 tablet on each successive day.

Rx:

Prednisone tablets 5 mg

Disp: 40 tablets

Sig: Take 5 tablets in the morning for 5 days; then 5 tablets in the morning every other day until gone.

Rx:

Tacrolimus 0.03% ointment

Disp: 30-g tube

Sig: Apply to affected areas twice daily as directed.

Some clinicians have had increased success by combining both topical rinses (dexamethasone) and ointments (triamcinolone) using them concomitantly for more severe cases.

If oral discomfort recurs, the patient should return to the clinician for reevaluation.

Many studies suggest that oral lichen planus has an intrinsic property that predisposes to malignant transformation. However, the origin is complex, and interaction among genetic factors, infectious agents, and environmental and lifestyle factors is involved in its development. Prospective studies have shown that patients with lichen planus have a slightly increased risk for development of oral squamous cell carcinoma. All patients who exhibit intraoral lichen planus, particularly those who have had the ulcerative form, should undergo periodic follow-up evaluation.

Therapy with medications such as systemic steroids, immunosuppressants, and immunomodulators is presented to inform the clinician that such modalities have been

reported to be effective for patients with ulcerative lichen planus. Medications such as azathioprine, mycophenolate mofetil, tacrolimus, hydroxychloroquine sulfate, acitretin, and cyclosporine are useful for treating patients with severe, persistent, ulcerative lichen planus but should not be routinely used because of the potential for adverse effects. Close collaboration with the patient's physician is recommended when these medications are prescribed.

Phased Therapy. In many cases of these oral erosive-ulcerative conditions (e.g., recurrent aphthous stomatitis, oral lichen planus), the therapy will only temporarily ameliorate the condition. Because the condition will remain (although less acute) or return over time, the clinician may choose to place the patient on a maintenance or less potent treatment during the remission (or less acute phase), thereby reducing the frequency and severity of flares.

For mild to moderate relief:

“Special Mouthwash”

Rx: Refer to earlier section, “Recurrent Aphthous Stomatitis,” for formulation.

PEMPHIGUS AND MUCOUS MEMBRANE PEMPHIGOID

Pemphigus and mucous membrane pemphigoid are relatively uncommon lesions. These should be suspected when chronic, multiple oral ulcerations and a history of oral and skin blisters are present. Often, they occur only in the mouth. The diagnosis is based on patient history and on the histologic and immunofluorescent characteristics of a biopsy specimen of the primary lesion.

Etiology

Both are autoimmune diseases with autoantibodies against antigens that appear in different portions of the epithelium (mucosa). In pemphigus, the antigens are found within the epithelium (desmosomes), and in pemphigoid, the antigens are located at the base of the epithelium within the hemidesmosomes.

Clinical Characteristics

In pemphigus, the lesion may stay in a single location for a long time, and small, placid bullae may develop. The bullae may rupture, leaving an ulcer. Approximately 80% to 90% of patients have oral lesions. In approximately two thirds of patients, oral manifestations are the first sign of disease. All parts of the mouth may become involved. The bullae rupture almost immediately in the mouth but may stay intact for some time on the skin. One of the classic signs, Nikolsky's sign (blister formation induced by gentle rubbing of an affected mucosal site), is present in pemphigus but is not pathognomonic because it also has been found to be present in other disorders. Because the vesicles or bullae are intraepithelial, they often are filled with clear fluid. On histologic examination,

a cleavage (e.g., Tzanck cells, acantholytic cells) within the spinous layer of the epithelium is seen.

In pemphigoid, the cleavage or split is beneath the epithelium, resulting in formation of bullae that usually are blood filled. Mucous membrane pemphigoid often is limited to the oral cavity, but some patients have ocular lesions (e.g., symblepharon, ankyloblepharon) that must be evaluated by an ophthalmologist. Gingiva is the oral site that is most commonly involved. Pemphigoid may appear clinically as a red, nonulcerated gingival lesion.

Rationale for Treatment

Because both pemphigus and pemphigoid are autoimmune disorders, the primary treatment consists of topical or systemic steroids or other immunomodulating drugs. Custom trays may be used to localize topical steroid medications on the gingival tissues (occlusive therapy). Because they may resemble other ulcerative bullous diseases, biopsy is necessary for a definitive diagnosis. Specimens should be submitted for light microscopic, immunofluorescent, and immunologic testing. Because of the potentially serious nature of the disorder, referral to a specialist in oral medicine, dermatology, and ophthalmology must be considered. When eye lesions are present, an ophthalmologist must be consulted immediately in an effort to prevent blindness.

Therapy with medications such as systemic steroids, immunosuppressants, and immunomodulators is presented to inform the clinician that such modalities have been reported to be effective for patients with vesiculobullous disorders such as pemphigus vulgaris and mucous membrane pemphigoid. Therapies such as regimens based on dapsone, methotrexate, mycophenolate mofetil, cyclosporine, and niacinamide with tetracycline, as well as plasmapheresis, are useful for treating patients with vesiculobullous disorders such as pemphigus vulgaris and mucous membrane pemphigoid but should not be routinely used because of the potential for adverse effects. Close collaboration with the patient's physician is recommended when these medications are prescribed.

Injectable Steroids. Dexamethasone phosphate injectable, 1 ampule (4 mg/mL), may be used in the following manner. After the area is injected with lidocaine, 0.5 to 1 mL should be injected around the margins of the ulcer with a 25-gauge needle, twice a week until the ulcer heals. Therapy with systemic or injectable steroids should be coordinated with the patient's physician because of adverse effects and potential systemic complications.

ORAL ERYTHEMA MULTIFORME

Etiology

Oral erythema multiforme is believed to be an autoimmune condition that may occur at any age. Drug reactions to medications such as penicillin and sulfonamides may play a role in some cases. In a few patients who developed

oral erythema multiforme, a herpetic infection immediately preceded the onset of clinical signs.

Clinical Description

Signs of oral erythema multiforme include “blood-crusted” lips, “targetoid” or “bull’s-eye” skin lesions, and a nonspecific mucosal slough. The designation *multiforme* signifies that its appearance may take multiple forms.

A severe form of erythema multiforme is called *Stevens-Johnson syndrome* or *erythema multiforme major*. Erythema multiforme, as a skin disease, occurs most often as the result of an allergic reaction.

Rationale for Treatment

Treatment is primarily antiinflammatory in nature. Steroids are initiated and then tapered. Because of the possible relationship of oral erythema multiforme with herpes simplex virus, suppressive antiviral therapy may be necessary before steroid therapy is initiated. Patients should be questioned carefully about a previous history of recurrent herpetic infection and prodromal symptoms that may have preceded the onset of erythema multiforme.

Dosing must be titrated to specific situations.

Steroid Therapy

Rx:

Prednisone tablets 10 mg

Disp: 100 tablets

Sig: Take 6 tablets in the morning until lesions recede; then decrease by 1 tablet on each successive day.

Suppressive Antiviral Therapy. Renew, as needed, the following:

Rx:

Acyclovir (Zovirax) 400-mg capsules

Disp: 90 capsules

Sig: Take 1 tablet three times a day.

Rx:

Valacyclovir (Valtrex) 500-mg capsules

Disp: 30 capsules

Sig: Take 1 tablet daily.

DENTURE SORE MOUTH

Etiology

Discomfort under oral prosthetic appliances may result from combinations of candidal infection, poor denture hygiene, an occlusive syndrome, overextension, and excessive movement of the appliance. This condition may be erroneously attributed to an allergy to denture material, which is a rare occurrence. Retention and fit of the denture should be idealized, and mechanical irritation should be ruled out.

Clinical Description

The tissue covered by the appliance, especially one made of acrylic, is erythematous and smooth or granular, and the condition may be asymptomatic or associated with burning.

Rationale for Treatment

Therapy is directed toward controlling all possible origins and improving oral comfort. If therapy is ineffective, underlying systemic conditions such as diabetes mellitus and poor nutrition should be considered.

The following protocol is recommended:

1. Institute appropriate antifungal medication (see “**Candidiasis**”).
2. Improve oral and appliance hygiene. The patient may have to leave the appliance out for extended periods and should be instructed to leave out the denture overnight. The appliance should be placed in a commercially available denture cleanser, or it can be soaked in a 1% sodium hypochlorite solution (1 teaspoon of sodium hypochlorite in a denture cup of water) for 15 minutes and thoroughly rinsed for at least 2 minutes under running water.
3. Reline, rebase, or construct a new appliance.
4. Apply an artificial saliva or oral lubricant gel, such as Laclede Oral Balance or Sage Gel to the tissue contact surface of the denture to reduce frictional trauma.

If all of the foregoing measures fail to control symptoms, biopsy or a short trial of topical steroid therapy may be used to rule out contact mucositis (an allergic reaction to denture materials). If a therapeutic trial fails to resolve the condition, a biopsy should be performed to establish the diagnosis.

For mild to moderate relief:

“Special Mouthwash”

Rx: Refer to earlier section, “Recurrent Aphthous Stomatitis,” for formulation.

BURNING MOUTH SYNDROME

Etiology

Multiple conditions have been implicated in the causation of burning mouth syndrome. Current literature favors neurogenic, vascular, and psychogenic causes. However, other conditions such as xerostomia, candidiasis, referred pain from the tongue musculature, chronic infection, reflux of gastric acid, use of medications, blood dyscrasias, nutritional deficiency, hormonal imbalance, and allergic and inflammatory disorders must be considered.

Clinical Description

Burning mouth syndrome is characterized by the presence of oral burning symptoms and the absence of clinical signs.

Rationale for Treatment

To reduce discomfort by addressing possible causative factors.

Treatment begins with ruling out all possible organic causes on the basis of history, physical evaluation, and specific laboratory studies. Minimal blood studies should

include complete blood count (CBC) and differential fasting, glucose, iron, ferritin, folic acid, vitamin B₁₂, and a thyroid profile (thyroid-stimulating hormone [TSH], triiodothyronine [T₃], and thyroxine [T₄]).

Rx:

Diphenhydramine (Children's Benadryl) elixir
12.5 mg/5 mL (OTC)

Disp: 1 bottle

Sig: Rinse with 1 teaspoon for 2 minutes before each meal and swallow.

Children's Benadryl is alcohol free.

For mild to moderate relief:

"Special Mouthwash"**Rx:**

Refer to earlier section, "Recurrent Aphthous Stomatitis," for formulation.

When burning mouth is considered psychogenic or idiopathic, use of a tricyclic antidepressant (TCA) or a benzodiazepine in low doses has been associated with properties of analgesia and sedation and frequently is successful in reducing or eliminating symptoms after several weeks or months. The dosage is adjusted according to the patient's reaction and clinical symptoms.

Rx:

Clonazepam (Klonopin) tablets 0.5 mg

Disp: 100 tablets

Sig: Take 1 tablet three times a day; then adjust dose after 3-day intervals.

This therapy probably is best managed by an appropriate specialist or by the patient's physician.

Rx:

Amitriptyline (Elavil) tablets 25 mg

Disp: 50 tablets

Sig: Take 1 tablet at bedtime for 1 week and then 2 tablets at bedtime. Increase to 3 tablets at bedtime after 2 weeks and maintain at that dosage or titrate as appropriate.

Rx:

Chlordiazepoxide (Librium) tablets 5 mg

Disp: 50 tablets

Sig: Take 1 or 2 tablets three times a day.

Rx:

Alprazolam (Xanax) tablets 0.25 mg

Disp: 50 tablets

Sig: Take 1 tablet three times a day.

Rx:

Diazepam (Valium) tablets 2 mg

Disp: 50 tablets

Sig: Take 1 or 2 tablets.

Obviously, these are psychological therapies, so the clinician may prefer to make an appropriate referral or to coordinate care with a behavioral therapist professional. If the clinician elects to treat with these agents, the dosage should be adjusted according to the patient's response. Anticipated adverse effects are dry mouth and morning drowsiness. The rationale for the use of TCAs and other psychotropic drugs should be thoroughly explained to

the patient, and the patient's physician should be made aware of the treatment. These medications have a potential for addiction and dependence.

Other agents that may provide relief:

Rx:

Tabasco sauce (Capsaicin) (OTC)

Disp: 1 bottle

Sig: Place 1 part Tabasco sauce in 2 to 4 parts water. Rinse for 1 minute four times a day and expectorate.

Rx:

Capsaicin (Zostrix) cream 0.025% (OTC)

Disp: 1 tube

Sig: Apply sparingly to affected site(s) four times a day.

Wash hands after each application, and do not use near the eyes.

Topical capsaicin may serve to relieve the burning sensation in some patients. An increase in discomfort for a 2- to 3-week period should be anticipated.

CHAPPED OR CRACKED LIPS

Etiology

Alternate wetting and drying, resulting in inflammation and possible secondary infection.

Clinical Description

The surface of the vermilion is rough and peeling and may be ulcerated with crusting. Normal vertical fissuring may be lost.

Rationale for Treatment

A cracked or abraded and chronically inflamed surface invites secondary infection. Use of an antiinflammatory agent in a petrolatum or adhesive base will interrupt the cycle of surface irritation and damage, allowing healing.

Rx:

Betamethasone valerate (Valisone) ointment 0.1%

Disp: 15-g tube

Sig: Apply to the lips after each meal and at bedtime.

Prolonged use of corticosteroids can result in thinning of the tissue. Their use should be closely monitored.

For maintenance, frequent application of lip care products (e.g., Blistex, ChapStick, Vaseline, cocoa butter) should be suggested.

If lesions do not resolve with treatment, consider biopsy to rule out dysplasia or malignancy.

GINGIVAL ENLARGEMENT

Etiology

Phenytoin sodium (Dilantin), calcium channel blocking agents (nifedipine and others), and cyclosporine are drugs that are known to predispose some patients to gingival enlargement. Blood dyscrasias and hereditary fibromatosis

should be ruled out by history and indicated laboratory tests.

Clinical Description

Gingival tissues, especially in the anterior region, are dense, resilient, insensitive, and enlarged but essentially of normal color.

Rationale for Treatment

Local factors, such as plaque and calculus accumulation, contribute to secondary inflammation and the hyperplastic process. This further interferes with plaque control. Specific drugs tend to deplete serum folic acid levels; this results in compromised tissue integrity. Folic acid and drug serum levels should be determined every 6 months. This assessment should be coordinated with the patient's physician.

Treatment consists of (1) meticulous plaque control, (2) gingivoplasty when indicated, and (3) folic acid oral rinse.

Rx:

Folic acid oral rinse 1 mg/mL

Disp: 16 oz

Sig: Rinse with 1 teaspoonful for 2 minutes twice a day and spit out.

Rx:

Chlorhexidine gluconate (Peridex) 0.12%

Disp: 16 oz

Sig: Rinse with ½ oz twice a day for 30 seconds and spit out.

TASTE DISORDERS

Etiology

Taste acuity may be affected by neurologic and physiologic changes and drugs. Diagnostic procedures should first rule out a neurologic deficiency; an olfactory deficit; and systemic influences such as malnutrition, metabolic disturbances, drugs, chemical and physical trauma, and radiation sequelae. Blood tests for trace elements should be conducted to identify any deficiencies.

Rationale for Treatment

A reduction in salivary flow may concentrate electrolytes in the saliva, resulting in a salty or metallic taste. (See treatment discussion under "Xerostomia.") A deficiency of zinc has been associated with a loss of taste (and smell) sensation.

For zinc replacement (in patients with proven zinc deficiency):

Rx:

Orazinc capsules 220 mg (OTC)

Disp: 100 capsules

Sig: Take 1 capsule with milk three times a day for at least 1 month.

Rx:

Z-Bec tablets (OTC)

Disp: 60 tablets

Sig: Take 1 tablet daily with food or after meals.

MANAGEMENT OF PATIENTS RECEIVING ANTINEOPLASTIC AGENTS AND RADIATION THERAPY

Etiology

Cancer chemotherapy and radiation to the head and neck tend to reduce the volume and alter the character of the saliva. The balance of the oral flora is disrupted, allowing overgrowth of opportunistic organisms (e.g., *C. albicans*). Also, anticancer therapy damages fast-growing tissues, especially in the oral mucosa.

Clinical Description

The oral mucosa becomes red and inflamed. The saliva is viscous or absent.

Rationale for Treatment

Treatment of these patients is symptomatic and supportive. Patient education, frequent monitoring, and close cooperation with the patient's physician are important. Oral discomfort may be relieved by topical anesthetics such as diphenhydramine elixir (Benadryl) and dyclonine (Dyclone). Artificial salivas (e.g., Sage Moist Plus, Moi-Stir, Salivart, Xero-Lube) reduce oral dryness. Mouth moisturizing gels (e.g., Sage Mouth Moisturizer, Oralbalance Gel) also may be helpful. Nystatin and clotrimazole preparations control fungal overgrowth. Chlorhexidine rinses help control plaque and candidiasis. Fluorides are applied for caries control. A patient information sheet on this topic is presented in [Box C.1](#), which can be reproduced as a patient handout.

Mouth Rinses

Rx:

Alkaline saline (salt/bicarbonate) mouth rinse—mix ½ teaspoonful each of salt and baking soda in a glass of water.

Sig: Rinse with copious amounts four times a day.

Commercially available as Sage Salt and Soda Rinse.

Gingivitis Control

Rx:

Chlorhexidine gluconate mouthwash (Peridex) 0.12%

Disp: 32 oz

Sig: Rinse with ½ oz twice a day for 30 seconds, and spit out. Avoid rinsing or eating for 30 minutes after treatment. (Rinse after breakfast and at bedtime.)

In patients with xerostomia, chlorhexidine (Peridex) should be used concurrently with an artificial saliva to provide the needed protein binding agent for efficacy and substantivity.

Caries Control. (See "Xerostomia.")

Rx:

Neutral NaF gel (Thera-Flur-N) 1.0%

BOX C.1 Oral Care Patient Information Sheet

Listed here are general guidelines for oral care to be individualized by your doctor. Follow your doctor's advice or discuss any questions with your doctor if these guidelines differ from what you've been told or have heard.

A. Rinses

1. Rinse with warm, dilute solution of sodium bicarbonate (baking soda) or salt and bicarbonate every 2 hours to bathe the tissues and control oral acidity. Take 2 teaspoonfuls of bicarbonate (or 1 teaspoonful of table salt plus 1 teaspoonful of bicarbonate) per quart of water.
2. If you are experiencing pain, rinse with 1 teaspoonful of elixir of Benadryl before each meal. Be careful when eating while your mouth is numb to avoid choking.
3. If your mouth is dry, sip cool water frequently (every 10 minutes) all day long. Allowing ice chips to melt in your mouth is comforting. Artificial salivas (e.g., Moi-Stir, Salivart, Xero-Lube, Orex) can be used as frequently as needed to make your mouth moist and "slick." Keep the lips lubricated with petrolatum or a lanolin-containing lip preparation. Commercial mouth rinses with alcohol and coffee, tea, and colas should be avoided as they tend to dry the mouth.
4. If an oral yeast infection develops, antifungal medications can be prescribed.
 - a. Nystatin pastille,* let 1 dissolve in the mouth five times a day, or
 - b. Let a 10-mg clotrimazole (Mycelex)* troche dissolve in the mouth five times a day.

B. Care of Teeth and Gums

1. Floss your teeth after each meal. Be careful not to cut your gums.
2. Brush your teeth after each meal. Use a soft, even-bristle brush and a bland toothpaste containing fluoride (e.g., Aim,

Crest, Colgate). Brushing with a sodium bicarbonate–water paste also is helpful. Arm & Hammer Dental Care toothpaste and tooth powder are bicarbonate based. If a toothbrush is too irritating, cotton-tipped swabs (Q-Tips) or foam sticks (Toothettes) can provide some mechanical cleaning.

3. A pulsating water device (e.g., Waterpik) will remove loose debris. Use warm water with a half-teaspoonful of salt and baking soda and low pressure to prevent damage to tissue.
4. Have custom, flexible vinyl trays made by your dentist for use in self-applying fluoride gel to your teeth for 5 minutes once a day after brushing.
5. Rinse with an antiplaque solution (Peridex) (if prescribed by your dentist) two or three times a day when you cannot follow other oral hygiene procedures.
6. Follow any alternative oral hygiene instructions prescribed by your dentist.

C. Nutrition

Adequate intake of nutrition and fluid is very important for oral and general health. Use diet supplements (e.g., Carnation Breakfast Essentials, Meritene, Ensure). If your mouth is sore, a blender may be used to soften food.

D. Maintenance

Have your oral health status evaluated at regularly scheduled intervals by your dentist.

E. Supportive

A humidifier in the sleeping area will alleviate or reduce nighttime oral dryness. NOTE: The oral regimen for patients receiving chemotherapy and radiotherapy is outlined in [Chapter 26](#) of this textbook. This regimen also is applicable to patients with acquired immunodeficiency syndrome (AIDS).

*Drugs that must be prescribed by your dentist or physician.

Disp: 24 mL

Sig: Place 1 drop per tooth in the custom tray; apply for 5 minutes daily. Avoid rinsing and eating for 30 minutes after treatment.

Topical Anesthetics**Rx:**

Diphenhydramine (Benadryl) elixir 12.5 mg/5 mL (NOTE: elixir is Rx, and syrup [Benylin] is OTC) 4 oz, mixed with Kaopectate (OTC) 4 oz, to make a 50% mixture by volume

Disp: 8 oz

Sig: Rinse with 1 teaspoonful every 2 hours and spit out.

Maalox (OTC) can be used in place of Kaopectate. Dyclonine (Dyclone) HCl 0.5% 1 oz may be added to this preparation for greater anesthetic efficacy.

Rx:

Diphenhydramine (Benadryl) elixir 12.5 mg/5 mL (NOTE: elixir is Rx, and syrup [Benylin] is OTC)

Disp: 4-oz bottle

Sig: Rinse with 1 teaspoonful for 2 minutes before each meal and spit out.

Rx:

Dyclonine HCl (Dyclone) 0.5% or 1%

Disp: 1-oz bottle

Sig: Rinse with 1 teaspoonful for 2 minutes before each meal and spit out.

For mild to moderate relief:

"Special Mouthwash"

Rx: Refer to earlier section, "Recurrent Aphthous Stomatitis," for formulation.

Antifungals. (See "Candidiasis.")

Rx:

Clotrimazole (Mycelex) troches 10 mg

Disp: 70 troches

Sig: Let 1 troche dissolve in the mouth five times a day.

Rx:

Nystatin pastilles 200,000 U

Disp: 50 pastilles

Sig: Let 1 pastille dissolve in the mouth five times a day.

(See under "Candidiasis" for additional antifungal therapy.)

KEY POINTS TO REMEMBER

- When topical anesthetics are used, patients should be warned about a reduced gag reflex and the need for caution while eating and drinking to avoid possible airway compromise. Allergies are rare but may occur.
- In immunocompromised patients, herpes simplex virus lesions can occur on any mucosal surface and may have an atypical appearance. They may resemble major aphthae and allergic responses.
- Mixing ointments with equal parts of Orabase promotes adhesion.
- Therapy with systemic steroids and immunosuppressants is presented to inform the clinician that such modalities are available. Because of the potential for adverse effects, close collaboration with the patient's physician is recommended when these medications are prescribed.
- Although some consultants disagree with the intraoral use of vaginal creams, the clinical efficacy of these creams has been observed in selected cases when other topical antifungal agents have failed.
- Generic carboxymethyl cellulose solutions may be prepared by a pharmacist. These cholinergics should be prescribed in consultation with a physician because of the potential for significant adverse effects.
- The rationale for use of TCAs and other psychotropic drugs should be thoroughly explained to patients, and the primary care physician also should be made aware of the treatment. These medications have a potential for addiction and dependency.
- When testing for serum folate level, it is judicious also to check the vitamin B₁₂ level because a vitamin B₁₂ deficiency can be masked by the patient's use of a folic acid supplement. The phenytoin level also should be assessed for future reference. NOTE: The treatment protocols included herein were adapted with permission from Siegel MA, Silverman S, Sollecito TP, editors: *Clinician's guide to treatment of common oral conditions*, ed 5, Baltimore, American Academy of Oral Medicine, 2001, and were provided as a courtesy of the American Academy of Oral Medicine (AAOM), which publishes a guide for clinicians: Siegel M, Silverman S, Sollecito T: *Clinician's guide: treatment of common oral lesions*, Hamilton, Ontario, Canada, BC Decker, 2006. This guide contains much of this same information. We (all members of the AAOM) acknowledge our deep appreciation for the authorization to publish this appendix. Some portions of that text are reprinted here with permission of the AAOM. For further information or to purchase a copy of the *Clinician's guide to treatment of common oral conditions*, contact Jane Kantor, CMP, American Academy of Oral Medicine, PO Box 2016, Edmonds, WA 98020. Phone: 425 778-6162; fax: 425 771-9588; website: www.aaom.com; email: .jkantor@aaom.com

SUGGESTED READING

- Boger J, Araujo O, Flowers F. Sunscreens: efficacy, use and misuse. *South Med J*. 1984;77:1421-1427.
- Brooke RI, Sapp JP. Herpetiform ulceration. *Oral Surg Oral Med Oral Pathol*. 1976;42:182-188.
- Brown RS, Bottomley WK. Combination immunosuppressant and topical steroid therapy for treatment of recurrent major aphthae. *Oral Surg Oral Med Oral Pathol*. 1990;69:42-44.
- Browning S, et al. The association between burning mouth syndrome and psychosocial disorders. *Oral Surg Oral Med Oral Pathol*. 1987;64:171-174.
- Burns RA, Davis WJ. Recurrent aphthous stomatitis. *Am Fam Physician*. 1988;32:99-104.
- Bystryrn JC. Adjuvant therapy of pemphigus. *Arch Dermatol*. 1984;120:941-951.
- Dilley D, Blozis G. Common oral lesions and oral manifestations of systemic illnesses and therapies. *Pediatr Clin North Am*. 1982;29:585-611.
- Drew HJ, et al. Effect of folate on phenytoin hyperplasia. *J Clin Periodontol*. 1987;14:350-356.
- Duxbury AJ, Hayes NF, Thakkar NS. Clinical trial of a mucin-containing artificial saliva. *IRCS Med Sci*. 1985;13:1197-1198.
- Fardal O, Turnbull RS. A review of the literature on use of chlorhexidine in dentistry. *J Am Dent Assoc*. 1986;112:863-869.
- Feinmann C. Pain relief by antidepressants: possible modes of action. *Pain*. 1985;23:1-8.
- Fenske NA, Greenberg SS. Solar-induced skin changes. *Am Fam Physician*. 1982;25:109-117.
- Fox PC. Systemic therapy of salivary gland hypofunction. *J Dent Res*. 1987;66:689-692. (special issue).
- Gabriel SA, et al. Lichen planus: possible mechanisms of pathogenesis. *J Oral Med*. 1985;40:56-59.
- Gorsku M, Silverman S, Chinn H. Clinical characteristics and management outcome in the burning mouth syndrome. *Oral Surg Oral Med Oral Pathol*. 1991;72:192-195.
- Gorsline J, Bradlow HL, Sherman MR. Triamcinolone acetonide 21-oic acid methyl ester: a potent local anti-inflammatory steroid without detectable systemic effects. *Endocrinology*. 1985;116:263-273.
- Greenberg MS. Oral herpes simplex infections in immunosuppressed patients. *Compendium*. 1988;9(suppl):289-291.
- Grushka M. Clinical features of burning mouth syndrome. *Oral Surg Oral Med Oral Pathol*. 1987;63:30-36.
- Hay KD, Reade PC. The use of an elimination diet in the treatment of recurrent aphthous ulceration of the oral cavity. *Oral Surg Oral Med Oral Pathol*. 1984;57:504-507.
- Holst E. Natamycin and nystatin for treatment of oral candidiasis during and after radiotherapy. *J Prosthet Dent*. 1984;51:226-231.
- Huff JC, et al. Therapy of herpes zoster with oral acyclovir. *Am J Med*. 1988;85:85-89.
- Hughes WT, et al. Ketoconazole and candidiasis: a controlled study. *J Infect Dis*. 1983;147:1060-1063.

- Katz S. The use of fluoride and chlorhexidine for the prevention of radiation caries. *J Am Dent Assoc.* 1982;104:164-169.
- Lamey PJ, et al. Vitamin status of patients with burning mouth syndrome and the response to replacement therapy. *Br Dent J.* 1986;160:81-84.
- Lang NP, Brex MC. Chlorhexidine digluconate—an agent for chemical plaque control and prevention of gingival inflammation. *J Periodont Res.* 1986;43(suppl):74-89.
- Lever WF, Schaumburg-Lever G. Treatment of pemphigus vulgaris: results obtained in 84 patients between 1961 and 1982. *Arch Dermatol.* 1984;120:44-47.
- Lozada F, Silverman S Jr, Migliorati C. Adverse side effects associated with prednisone in the treatment of patients with oral inflammatory ulcerative diseases. *J Am Dent Assoc.* 1984;109:269-270.
- Lucatorto FM, et al. Treatment of refractory oral candidiasis with fluconazole: a case report. *Oral Surg Oral Med Oral Pathol.* 1991;71:42-44.
- Lundeen RC, Langlais RP, Terezhalmay GT. Sunscreen protection for lip mucosa: a review and update. *J Am Dent Assoc.* 1985;111:617-621.
- O'Neil T, Figures K. The effects of chlorhexidine and mechanical methods of plaque control on the recurrence of gingival hyperplasia in young patients taking phenytoin. *Br Dent J.* 1982;152:130-133.
- Owens NJ, et al. Prophylaxis of oral candidiasis with clotrimazole troches. *Arch Intern Med.* 1984;144:290-293.
- Poland JM. The spectrum of HSV-1 infections in nonimmunosuppressed patients. *Compendium.* 1988;9(suppl):310-312.
- Porter SR, Scully C, Flint S. Hematologic status in recurrent aphthous stomatitis compared with other oral disease. *Oral Surg Oral Med Oral Pathol.* 1988;66:41-44.
- Raborn GW, et al. Oral acyclovir and herpes labialis: a randomized, double-blind, placebo-controlled study. *J Am Dent Assoc.* 1987;111:38-42.
- Rhodus NL, et al. *Candida albicans* levels in patients with Sjögren's syndrome before and after long-term use of pilocarpine hydrochloride. *Quintessence Int.* 1998;29:705-710.
- Rhodus NL, Schuh MJ. The effects of pilocarpine on salivary flow in patients with Sjögren's syndrome. *Oral Surg Oral Med Oral Pathol.* 1991;72:545-549.
- Rowe NJ. Diagnosis and treatment of herpes simplex virus disease. *Compendium.* 1988;9(suppl):292-295.
- Schiffman SS. Taste and smell in disease (parts a and b). *N Engl J Med.* 1983;308:1275-1279.
- Scully C, Mason DK. Therapeutic measures in oral medicine. In: Jones JH, Mason DK, eds. *Oral Manifestations of Systemic Disease.* London: Saunders; 1980.
- Sharav Y, et al. The analgesic effect of amitriptyline on chronic facial pain. *Pain.* 1987;31:199-207.
- Silverman S Jr, et al. A prospective study of findings and management in 214 patients with oral lichen planus. *Oral Surg Oral Med Oral Pathol.* 1991;72:665-670.
- Silverman S Jr, et al. Oral mucous membrane pemphigoid: a study of sixty-five patients. *Oral Surg Oral Med Oral Pathol.* 1986;61:233-237.
- Sonis ST, Sonis AL, Lieberman A. Oral complications in patients receiving treatment for malignancies other than of the head and neck. *JAMA.* 1978;97:468-471.
- Straus SE. Herpes simplex virus infection: biology, treatment, and prevention. *Ann Intern Med.* 1985;103:404-419.
- Thompson PJ, et al. Assessment of oral candidiasis in patients with respiratory disease and efficacy of a new nystatin formulation. *BMJ.* 1986;292:699-700.
- Vincent SD, et al. Oral lichen planus: the clinical, historical and therapeutic features of 100 cases. *Oral Surg Oral Med Oral Pathol.* 1990;70:165-171.
- Wood MJ, et al. Efficacy of oral acyclovir treatment of acute herpes zoster. *Am J Med.* 1988;85:79-83.
- Wright WE, et al. An oral disease prevention program for patients receiving radiation and chemotherapy. *J Am Dent Assoc.* 1985;110:43-47.

Drug Interactions of Significance in Dentistry

Dental Drug	Interacting Drug	Medical Condition or Situation	Effect
ANTIBIOTICS			
Antibiotics	Oral contraceptives (birth control pills)	Contraception	Decreased effectiveness of oral contraceptives has been suggested for several antibiotic classes because of the potential for lowering plasma levels of the contraceptive drug. However, most well-designed studies do not show any reduction in estrogen serum levels in patients taking antibiotics (except rifampin). RECOMMENDATION: Okay to use dental antibiotics. Provide advice to patient about potential risk and for consideration of additional contraceptive measures.
Beta-lactams (penicillins, cephalosporins)	Allopurinol (Lopurin, Zyloprim)	Gout	Incidence of minor allergic reactions to ampicillin is increased. Other penicillins have not been implicated. RECOMMENDATION: Avoid ampicillin.
	Beta-blockers (e.g., Tenormin, Lopressor, Inderal, Corgard)	Hypertension	Serum levels of atenolol are reduced after prolonged use of ampicillin. Anaphylactic reactions to penicillins or other drugs may be more severe in patients taking beta-blockers because of increased mediator release from mast cells. RECOMMENDATION: Use ampicillin cautiously; advise patient of potential reaction.
	Tetracyclines and other bacteriostatic antibiotics	Infection, acne, or periodontal disease	Effectiveness of penicillins and cephalosporins may be reduced by bacteriostatic agents. RECOMMENDATION: Avoid interaction.
Tetracyclines, fluoroquinolones	Antacids	Dyspepsia, gastroesophageal reflux, peptic ulcer	Antacids, dairy products, and other agents containing divalent (calcium, iron) and trivalent cations will chelate these antibiotics and limit their absorption. Doxycycline is least influenced by this interaction. RECOMMENDATION: Avoid interaction.
	Insulin	Diabetes mellitus	Doxycycline and oxytetracycline have been documented as enhancing the hypoglycemic effects of exogenously administered insulin. RECOMMENDATION: Select a different antibiotic or increase carbohydrate intake.
Doxycycline	Methotrexate	Immunosuppression	In patients taking high-dose methotrexate, interaction can lead to increased methotrexate concentrations, making toxicity likely. RECOMMENDATION: Select different antibiotic.
Metronidazole	Ethanol	Alcohol use or abuse	Severe disulfiram-like reactions are well documented. RECOMMENDATION: Avoid interaction.
	Lithium	Manic depression	Inhibits renal excretion of lithium, leading to elevated or toxic levels of lithium. Lithium toxicity produces confusion, ataxia, and kidney damage. RECOMMENDATION: Avoid interaction.

Continued

Dental Drug	Interacting Drug	Medical Condition or Situation	Effect
Antibiotics and antifungals metabolized by CYP3A4 and CYP1A2 (e.g., macrolide antibiotics [erythromycin, clarithromycin], antifungals [ketoconazole, fluconazole, itraconazole])	Benzodiazepines	Anxiety	Delayed metabolism of benzodiazepine, increasing the pharmacologic effects, can result in excessive sedation and irrational behavior. RECOMMENDATION: Reduce dose of benzodiazepine or avoid interaction.
	Buspirone	Depression	Delayed metabolism of buspirone, increasing pharmacologic effect. RECOMMENDATION: Avoid interaction.
	Calcium channel blockers (e.g., Diltiazem [Cardizem], Verapamil [Calan], Amlodipine [Norvasc])	Hypertension	Delayed metabolism of calcium channel blockers, increasing the pharmacologic effect, resulting in hypotension with use of macrolide antibiotics. RECOMMENDATION: Avoid interaction.
	Carbamazepine (Tegretol)	Seizure disorder	Increased blood levels of carbamazepine, leading to toxicity; symptoms include drowsiness, dizziness, nausea, headache, and blurred vision. Hospitalization has been required. RECOMMENDATION: Avoid interaction.
	Cisapride	Gastroesophageal reflux	Delayed metabolism of cisapride, increasing the pharmacologic effects and risk for cardiac arrhythmia and sudden death. RECOMMENDATION: Avoid interaction.
	Cyclosporine	Organ transplantation	Enhanced immunosuppression and nephrotoxicity. RECOMMENDATION: Avoid interaction.
	Disopyramide, Quinidine	Cardiac arrhythmias	Inhibits CYP3A4 metabolism, resulting in large increases in antiarrhythmia drug that can lead to arrhythmias. RECOMMENDATION: Avoid interaction.
	Lovastatin, pravastatin, simvastatin, and other statins	Hyperlipidemia	Increases plasma concentration of statin drugs; may result in muscle (eosinophilia) myalgia and rhabdomyolysis (muscle breakdown and pain) and acute renal failure. RECOMMENDATION: Avoid interaction.
	Pimozide	Antipsychotic, used to control motor tics	May result in increased concentrations of pimozide and possibly prolongation of the QT interval. RECOMMENDATION: Avoid interaction.
	Prednisone, methylprednisolone	Autoimmune disorders, organ transplantation	Increased risk of Cushing syndrome and immunosuppression RECOMMENDATION: Monitor patient and shorten duration of antibiotic administration if possible.
	Theophylline (Theo-Dur)	Asthma	Erythromycins inhibit the metabolism of theophylline, leading to toxic serum levels (symptoms of toxicity: headache, nausea, vomiting, confusion, thirst, cardiac arrhythmias, and convulsions). Conversely, theophylline reduces serum levels of erythromycin. RECOMMENDATION: Avoid prescribing erythromycin.
Antibiotics (especially erythromycin, clarithromycin, and tetracycline)	Digoxin (Lanoxin)	Congestive heart failure	Alters GI flora and retards metabolism of digoxin in roughly 10% of patients, resulting in dangerously high digoxin serum levels that may persist for several weeks after discontinuation of antibiotic. Strongest documentation has been acquired for macrolide antibiotics and tetracycline. Patients should be cautioned to report any signs of digitalis toxicity (salivation, visual disturbances, and arrhythmias) during antibiotic therapy. RECOMMENDATION: Safe in 90%; should have digoxin levels monitored during antimicrobial therapy.

Dental Drug	Interacting Drug	Medical Condition or Situation	Effect
Antibiotics, cephalosporins, erythromycin, clarithromycin, metronidazole	Warfarin (Coumadin)	Atrial fibrillation, MI, recent (postoperative) major surgery, stroke prevention	Anticoagulant effect of warfarin may be increased by several antibiotic classes. Reduced synthesis of vitamin K by gut flora is a putative mechanism, but several antibiotics have antiplatelet and anticoagulant activity. Cephalosporins, macrolide antibiotics, and metronidazole have the most convincing documentation, monitor INR. RECOMMENDATION: Penicillins, tetracyclines, and clindamycin are preferred choices but must be used cautiously.
ANALGESICS			
Acetaminophen	Alcohol	Alcohol use and abuse	Increased risk of liver toxicity, especially during fasting state or ≥ 4 g of acetaminophen per day. RECOMMENDATION: Use lower dose of acetaminophen and encourage discontinuation of alcohol use.
Acetaminophen	Warfarin (Coumadin)	Atrial fibrillation, thrombosis	Data are somewhat conflicting: Increased risk of bleeding if acetaminophen is given at a dose of >2 g/day for >1 week. RECOMMENDATION: Limit acetaminophen dosing and duration; monitor INR.
Aspirin	Oral hypoglycemic (e.g., sulfonylureas: Glyburide, chlorpropamide, acetohexamide)	Diabetes type 2	Increased hypoglycemic effects. RECOMMENDATION: Avoid interaction.
Aspirin, other NSAIDs	Anticoagulants (Coumarin)	Atrial fibrillation, MI, recent (postoperative) surgery, clot prevention	Increased risk of bleeding (GI, oral). RECOMMENDATION: Avoid interaction.
Aspirin, other NSAIDs	Alcohol	Alcohol use and abuse	Increased risk of GI bleeding. RECOMMENDATION: Lower dose; encourage discontinuation of alcohol use.
Aspirin	Diltiazem	Hypertension, angina	Enhanced antiplatelet activity of aspirin. RECOMMENDATION: Monitor for risk of prolonged bleeding. Advise patient to notify physician or dentist if she or he experiences unusual bleeding or bruising.
NSAIDs	Beta-blockers, ACE inhibitors, Alpha-blockers (doxazosin [Catapres], prazosin [Minipress]); or combined Alpha- Beta blockers (carvedilol [Coreg], labetalol [Normodyne])	Hypertension, recent MI	Decreased antihypertensive effect. RECOMMENDATION: Limit duration of NSAID dosage to about 4 days. Use acetaminophen products instead.
NSAIDs	Lithium	Manic depression	Produces symptoms of lithium toxicity, including nausea, vomiting, slurred speech, and mental confusion. RECOMMENDATION: NSAIDs should not be prescribed to patients who take lithium. It can result in toxic levels of lithium; consider consulting with physician to reduce lithium dose.
NSAIDs (Naproxen)	Alendronate	Osteoporosis, multiple myeloma	Increased risk for gastric ulcers. RECOMMENDATION: Use acetaminophen products.

Continued

Dental Drug	Interacting Drug	Medical Condition or Situation	Effect
NSAIDs	SSRIs (citalopram, fluoxetine, paroxetine, sertraline)	Depression	Increased risk of peptic ulcers. RECOMMENDATION: Avoid long-term use of NSAIDs; use acetaminophen products instead.
NSAIDs	Methotrexate (MTX)	Connective tissue disease, cancer therapy	Toxic level of methotrexate may accumulate. RECOMMENDATION: Avoid interaction if the patient is taking high-dose MTX for cancer therapy. Low-dose MTX for arthritis is not a concern.
Meperidine	MAO inhibitors (e.g., isocarboxazid, phenelzine)	Depressants (NOTE: MAO inhibitors often are last line of therapy)	May produce severe and potentially fatal adverse excitatory or depressive reactions RECOMMENDATION: Avoid interaction.
Propoxyphene	Carbamazepine	Seizure, trigeminal neuralgia	Can significantly increase the plasma concentrations of carbamazepine. RECOMMENDATION: Avoid interaction.
ANESTHETICS			
Lidocaine	Bupivacaine		Additive effect of these two local anesthetics increases the risk of CNS toxicity. RECOMMENDATION: Limit dose of each.
Lidocaine	Tramadol		May rarely cause seizures. More likely in elderly, those with seizures, or if undergoing alcohol drug withdrawal. RECOMMENDATION: Avoid interaction; limit dose.
Mepivacaine	Meperidine (Demerol)		Sedation with opioids may increase risk of local anesthetic toxicity; especially in children. RECOMMENDATION: Reduce anesthetic dose.
SEDATIVES			
Barbiturates	Digoxin, theophylline, corticosteroids, oral anticoagulants (coumarin)	Congestive heart failure, asthma, autoimmune disease, atrial fibrillation	Barbiturates bind P-450 cytochrome system in liver and enhance the metabolism of many drugs, reducing the effect of the anticoagulant. RECOMMENDATION: Generally avoid. If necessary, limit dose and observe for adverse effects.
	Benzodiazepines, alcohol, antihistamines	Anxiety, alcohol use and abuse, seasonal allergies	Additive effects for sedation and respiratory depression RECOMMENDATION: Reduce dose and administer combination of sedatives with extreme caution.
Benzodiazepines (BZDPs) (e.g., alprazolam, chlordiazepoxide, diazepam, triazolam)	Cimetidine, oral contraceptives, fluoxetine, isoniazid (INH), alcohol, azole antifungals (fluconazole, itraconazole, ketoconazole)	Peptic ulcer disease, depression, tuberculosis, alcohol use and abuse	Delayed metabolism of BZDP, increasing the systemic exposure and pharmacologic effects, can result in excessive sedation and adverse psychomotor effects. RECOMMENDATION: Reduce dose of benzodiazepine or avoid interaction.
	Digoxin (Lanoxin), phenytoin, theophylline (Theo-Dur)	Congestive heart failure, epilepsy, asthma	Serum concentrations of digoxin and phenytoin may be increased, resulting in toxicity. Antagonize sedative effects of benzodiazepine RECOMMENDATION: Avoid interaction.
	Protease inhibitors (indinavir, nelfinavir)	HIV infection and AIDS	Increased bioavailability and effects of benzodiazepines, especially triazolam and oral midazolam RECOMMENDATION: Avoid interaction.

Dental Drug	Interacting Drug	Medical Condition or Situation	Effect
VASOCONSTRICTORS			
Epinephrine and levonordefrine (Neo-Cobefrin)	Nonselective beta-blockers: propranolol (Inderal), nadolol (Corgard), penbutolol (Levaton), pindolol (Visken), sotalol (Betapace), timolol (Blocadren)	Angina pectoris, hypertension, glaucoma, migraine, headache, hyperthyroidism, panic syndromes	Unopposed effects—Increased blood pressure with secondary bradycardia RECOMMENDATION: Initial dose is one-half cartridge containing 1:100,000 epinephrine; aspirate to avoid intravascular injection, and inject slowly. Monitor vital signs; if no adverse cardiovascular changes occur, up to two cartridges containing a vasoconstrictor can be administered. Provide a 5-minute interval between the first and second cartridges, with continual monitoring. Avoid epinephrine-containing retraction cord and higher concentrations of epinephrine in the dental anesthetic.
	Cocaine	Illicit use, topical anesthetic for mucous membrane procedures	Blocks reuptake of norepinephrine and intensifies postsynaptic response to epinephrine-like drugs. This potentiates the adrenergic effects on the heart, with the potential for a heart attack. RECOMMENDATION: Recognize signs and symptoms of cocaine abuse; avoid use of vasoconstrictors in these patients until cocaine has been withheld for at least 24 hours.
	Halothane	General anesthetic for surgical procedures	Stimulation of alpha and beta receptors, resulting in arrhythmia at doses that exceed 2 µg/kg. RECOMMENDATION: Limit dose to remain below 2 µg/kg threshold; aspirate to avoid intravascular injection. Monitor vital signs. Avoid epinephrine-containing retraction cord and concentrations of epinephrine higher than 1:100,000.
	Tricyclic antidepressants* (amitriptyline [Elavil], amoxapine, clomipramine [Anafranil], desipramine [Norpramin], doxepin [Sinequan], imipramine [Tofranil], nortriptyline [Pamelor], protriptyline [Vivactil], trimipramine [Surmontil])	Depression, severe anxiety, neuropathic pain, attention deficit disorder	Blocks reuptake of norepinephrine, resulting in unopposed effects—increased pressor response (increased BP, increased heart rate)—and potential cardiac arrhythmias; effect is greater with levonordefrin. RECOMMENDATION: Avoid levonordefrin; limit dose to two cartridges containing 1:100,000 epinephrine (36 µg); aspirate to avoid intravascular injection. Monitor vital signs. Avoid epinephrine-containing retraction cord and higher concentrations of epinephrine in the dental anesthetic.
	MAO inhibitors (isocarboxazid [Marplan], phenelzine [Nardil], tranylcypromine [Parnate])	Depression	Although no reports have documented the effects on BP or heart rate after dental procedures, the potential for increased pressor response is present. RECOMMENDATION: Avoid levonordefrin; limit dose to two cartridges containing 1:100,000 epinephrine (36 µg); aspirate to avoid intravascular injection. Monitor vital signs. Avoid epinephrine-containing retraction cord and higher concentrations of epinephrine in the dental anesthetic.
	Antipsychotics Some examples: chlorpromazine (Thorazine), trifluoperazine (Stelazine), clozapine (Clozaril), olanzapine (Zyprexa)	Schizophrenia	Decrease BP (hypotension) RECOMMENDATION: Use only small amounts of epinephrine; limit dose to two cartridges containing 1:100,000 epinephrine (36 µg); aspirate to avoid intravascular injection. Monitor vital signs.

Continued

Dental Drug	Interacting Drug	Medical Condition or Situation	Effect
	Peripheral adrenergic antagonists (reserpine [Serpasil], guanethidine [Ismelin], guanadrel [Hylorel])	Hypertension	Potential for increased sensitivity of adrenergic receptors to epinephrine and levonordefrin. RECOMMENDATION: Administer cautiously. Monitor vital signs during and after administration of first cartridge. Limit dose to two cartridges containing 1:100,000 epinephrine (36 µg) or less, depending on vital signs and patient response. Aspirate to avoid intravascular injection. Avoid epinephrine-containing retraction cord and higher concentrations of epinephrine in the dental anesthetic.
	Catechol- <i>O</i> -methyltransferase inhibitors (tolcapone [Tasmar], entacapone [Comtan])	Parkinson disease	Potential for increased sensitivity of adrenergic receptors to epinephrine and levonordefrin, resulting in increased heart rate, BP, and arrhythmias RECOMMENDATION: Administer cautiously. Monitor vital signs during and after administration of first cartridge. Limit dose to two cartridges containing 1:100,000 epinephrine (36 µg) or less, depending on vital signs and patient response. Aspirate to avoid intravascular injection. Avoid epinephrine-containing retraction cord and higher concentrations of epinephrine in the dental anesthetic.

*Antidepressants, such as the selective serotonin reuptake inhibitors (SSRIs), do not interact with vasoconstrictors. However, antidepressants that block norepinephrine uptake (venlafaxine [Effexor], bupropion [Wellbutrin]) have the potential to interact with vasoconstrictors, resulting in pressor responses. *ACE*, Angiotensin-converting enzyme; *AIDS*, acquired immunodeficiency syndrome; *BP*, blood pressure; *CNS*, central nervous system; *GI*, gastrointestinal; *HIV*, human immunodeficiency virus; *INR*, international normalized ratio; *MAO*, monoamine oxidase; *MI*, myocardial infarction; *NSAID*, nonsteroidal antiinflammatory drugs.

Drugs Used in Complementary and Alternative Medicine of Potential Importance in Dentistry

Complementary and alternative medicine (CAM) is the combination of the practices of alternative and complementary medicine. The combination of these practices is referred to as CAM or more recently as complementary and integrative medicine (CIM). Complementary medicine and alternative medicine are defined below.¹

DEFINITIONS

Acupuncture²: A form of complementary medicine that originated in China in which the body is pricked or pierced with a sharp object such as a needle is simple, but the body, its object, is complex. The needle is inserted to restore harmony and balance (*yang* and *yin*). Acupuncture is not just about the yang and yin of a needle and a body but rather the system of ideas, understood relationships, and practices that inform clinicians about where the needle or needles might be placed to promote natural healing.

Yoga³: Comes from the root *yug*, meaning “to join together” or “union.” One interpretation is that of a spiritual union. An individual’s consciousness becomes united with what may be considered the Infinite Consciousness, the Divine Consciousness, or the Reality underlying the universe. Yoga as practiced in the West in modern times has less emphasis on spiritual union and more emphasis on performing physical yoga postures and meditation for physical and emotional well-being.

Arts therapies⁴: The creative arts therapies, expressive arts therapy, and arts in health care are all established approaches that invoke the therapeutic use of the arts. In the arts in health care, five loci are described: patient care, caregiver support, community well-being, the education of health care professionals about the arts, and creation of healing environments.

Alternative medicine^{1,5-7}: Practices that are used instead of mainstream medical practice.

Complementary medicine^{1,6}: Practices that are used as adjuncts to conventional medicine.

Complementary and alternative medicine¹: Combination of the practices of alternative and complementary medicine. These two systems are divided into the major categories listed below.

Alternative medical systems: The following are alternative medical systems: traditional Chinese,⁸ Ayurveda medicine of India,⁹ Native American healing approaches,¹⁰ biologically based therapies,¹¹ manipulative and body-based methods (chiropractic and osteopathic manipulation),^{12,13} mind-body interventions,¹⁴ and energy therapies (use of magnets and acupuncture).^{15,16} The use of yoga as a complementary therapy in clinical practice may lead to health benefits beyond traditional treatment alone; however, to effect changes in health care policy, more high-quality, evidence-based research is needed to effect changes in health care policy.¹⁶ This is the case with many of the systems listed above.

Both alternative medicine and complementary medicine use treatments that often have no established efficacy. It is estimated that about 42% of Americans use alternative and complementary medicine therapies, which are supported by an estimated \$30 billion industry.^{6,17,18}

Complementary medicines are defined as herbal medicines, homeopathic remedies, and essential oils.¹⁹⁻²⁴ The basic principle of homeopathy consists of selection of a remedy that, if given to a healthy person, will produce a range of symptoms similar to those observed in the ill patient (“like cures like”).^{20,21} Only minute amounts are given to avoid toxicity. Only one remedy is used at any one time.²² Dilute tinctures are used rather than concentrated ones. In homeopathic practice, it also is common to use medications in tablet form.²³

Standard tinctures used in Western traditional herbal medicine are very different from those used in homeopathy.²¹ Alcohol is used to dissolve the plant, and the final product is not diluted. Thus, these remedies are concentrated, highly potent preparations, and they usually are taken as the unmodified liquid tincture. Other preparations used in herbal remedies include lotions and creams for topical application. The tablet form of medication is not used very often (<5% of the time).²³

According to Eisenberg et al,²² herbal remedies most commonly are used to treat patients with allergies, insomnia, lung problems, and digestive problems. These preparations also are used for the treatment of asthma, cancer, depression, dementia, schizophrenia, bipolar

disorders, heart failure, rheumatologic conditions, and others.^{22,24-26}

A U.S. survey reported by Ernst found that 90% of patients with arthritis used alternative therapies such as those based on herbal medicines.²⁷ Both adults and children use them.^{22,28} In the United States, the sale of herbal remedies totaled \$1.6 billion in 1994, reaching \$4.0 billion by 1998.^{22,28} From 1999 to 2004, more than \$34 billion was spent on CAM treatments, with part of that going to herbal medicines.^{29,30} In another U.S. study, 136 (70% response rate) customers who had bought dietary supplements in one of two health food stores reported that they had used 805 supplements—84.3% were taken for disease prevention and wellness, and 15.7% were taken to treat perceived health problems. Garlic, ginseng, and *Ginkgo biloba* were the most commonly named herbal products.²² Klepser and colleagues³¹ reported that the incidence of use of herbal remedies among 794 persons studied in Iowa was 41.6%. Most of the users were white women and had been educated beyond the high school level.³¹ Patients with cardiovascular disease in Canada also were studied for their use of herbal products.³² About 17% were found to use such products.³² Products most commonly used were garlic, cayenne pepper, and ginseng.³²

A study reported the use of herbal supplements by adult dental patients in a U.S. dental school.³³ During a 1-month period, 12.6% of 1119 dental patients reported the use of one or more of 21 herbal products. A majority of these patients were middle-aged educated white women. Twenty-four percent of the patients used an herbal product as a single agent, and 76% used herbal products in combination with prescription or over-the-counter (OTC) medicines, or with both types of medicines. The five most frequently used herbal medicines were green tea, garlic, echinacea, *Ginkgo biloba*, and ginseng.

EFFICACY OF HERBAL MEDICINES

Many herbal remedies have been used for hundreds of years.^{34,35} However, traditional use is not in itself a good indication of efficacy. The “gold standard” for testing efficacy is the randomized controlled trial (RCT).³⁴ This standard should apply as much to herbal medicines as to conventional medicines. Numerous RCTs of herbal medical products have been conducted. However, many of these studies differ in how they were conducted and in their findings.³⁴ Ernst and Pitler³⁴ suggest that the best way to evaluate RCTs undertaken to assess the efficacy of a specific herbal medicine is to do a systematic review or metaanalysis of all RCTs for that product.

HERBAL MEDICINES WITH PROVEN EFFICACY

Several herbal remedies have been repeatedly tested in placebo-controlled RCTs.³⁴ Systematic reviews of these studies have shown that some herbal medicines are effective

for particular conditions.³⁴ For example, *Ginkgo biloba* has been shown to be effective for the symptomatic treatment of dementia and intermittent claudication.^{36,37} Echinacea and zinc lozenges were found to be beneficial for the treatment of the common cold.²⁹ Table E.1 lists the more commonly used herbal medicines that have proved effective for the condition(s) listed. Aloe vera has been found to be effective as a cavity disinfectant in minimally invasive dental procedures.³⁸

HERBAL MEDICINES WITH DOUBTFUL OR NO EFFICACY

Asian ginseng, one of the most popular herbal medicines in the United States, did not show convincing evidence for efficacy as a general tonic or as a means of enhancing mental and physical performance.³⁹ Studies involving the use of valerian as a hypnotic agent have been inconclusive.⁴⁰ A systematic review of RCTs showed that evening primrose was ineffective in treating women with premenstrual syndrome.⁴¹ Garlic was not found to be effective as a cholesterol-lowering agent.⁴² A review of herbal products used to treat asthma found little to no effectiveness.⁴³ Table E.2 lists some of the more common herbal medicines that were found not to be effective for the conditions listed.

ADVERSE EFFECTS AND ADVERSE REACTIONS

Recent increased use of herbal remedies seems to have resulted from the public’s view that natural products are harmless or at least have fewer adverse effects than those attributable to regular drugs.⁴⁴ The assumption that phytomedicines (herbal medicines) have only beneficial effects has proved to be incorrect.^{21,44}

Toxicity may be associated with the use of herbal remedies. These reactions may be due to accidental or deliberate contamination of the product. For example, lead, mercury, cadmium, pesticides, microorganisms, and fumigants have been found to contaminate some herbal products.⁴⁴ Substitution of animal substances such as enzymes, hormones, or organ extracts and synthetic drugs has accounted for some of the toxic reactions to herbal products.⁴⁴ Adulteration caused by the accidental or deliberate substitution of the original plant material by other plant species also has been reported to be a source of toxic reactions to herbal products.⁴⁴

Other adverse reactions to herbal products are intrinsic or plant associated.⁴⁴ In some cases, the manufacturer has ignored the known toxicity of a plant or constituent in the herbal product.⁴⁴ In other cases, the product contains plants for which no or insufficient data are available regarding safety. If a highly concentrated or a specifically processed extract is used, toxic reactions may occur. If a plant contains constituents known to affect the bioavailability or pharmacokinetics of other drugs, serious drug

TABLE E.1 Claims for Herbal Actions Supported by Clinical Trials

Herb	Claimed Action	Effectiveness Supported by Clinical Trials
Kava	Used to treat anxiety	Clinical trials have shown that it reduces anxiety to a significantly greater extent than placebo.
Artichoke	Used to lower lipid levels in blood	Only one randomized clinical study shows it to moderately lower elevated total cholesterol levels when given orally for several weeks.
Feverfew	Used for women's ailments and inflammatory diseases; more recently suggested as agent for treatment of headache and migraine	Three studies showed greater effect than placebo in alleviating symptoms of headache or migraine.
Garlic	Used for blood pressure reduction and lowering of blood lipid levels	Data show a small but statistically significant reduction in systolic and diastolic blood pressure. No data support the claims for lipid-lowering properties of garlic.
Ginger	Used to treat nausea and vomiting	Several studies support antiemetic uses for ginger. Used to treat or prevent nausea or vomiting.
Echinacea	Used to treat the common cold	Moderate effectiveness has been shown in five or six clinical trials.
<i>Ginkgo biloba</i>	Used to treat cerebral insufficiency and to prevent loss of cognitive function and tinnitus	Studies have shown it to be effective in the treatment of cerebral insufficiency when given for 4 to 6 weeks. Data show that regular oral intake of <i>Ginkgo biloba</i> slows the loss of cognitive function in patients with dementia.
Hawthorn	Used to treat heart failure	In various studies, it is shown to be effective for the early signs of congestive heart failure.
Horse chestnut	Used to treat venous congestion	Studies have shown it to be effective in reducing signs and symptoms of chronic venous insufficiency.
Saw palmetto	Used in Europe for symptoms of prostate enlargement	Clinical trials support its use for symptoms of benign prostatic hyperplasia.
St. John's wort	Used to treat depression	Studies show that it is effective for treating mild to moderate depression. The question of its effectiveness for severe depression remains unanswered.

TABLE E.2 Claims for Herbal Actions Unsupported by Clinical Trials

Herb	Claimed Action	Effectiveness Supported by Clinical Trials
Aloe vera	Used as an adjunctive oral treatment for diabetes and skin conditions such as herpes and psoriasis	At the present time, compelling data support none of the claims made for aloe vera. Recent studies are more supportive
Evening primrose	Used for the treatment of premenstrual syndrome	Current evidence suggests uncertain value when it is used to treat this syndrome.
Ginseng	Used to treat type 2 diabetes and herpes simplex infections. Also has been used to enhance physical and psychomotor performance, as well as cognitive function	Double-blind, randomized clinical trials do not support any effective action on physical performance, psychomotor performance, or cognitive function nor in type 2 diabetes and herpes simplex infections.
Guar gum	Used to treat obesity and overweight	Clinical trials have not supported this use.
Mistletoe	Has been suggested for the treatment of cancer	Current studies do not support these claims.
Peppermint	Used to treat irritable bowel syndrome	Studies show that it alleviates the symptoms of irritable bowel syndrome. However, many of these trials were flawed.
Valerian	Used to promote sleep	Randomized clinical studies are needed to evaluate effectiveness. Studies to date have been flawed.

interactions may occur.⁴⁴ Table E.3 lists some of the serious adverse reactions that can occur with natural product use.

MEDICAL PROBLEMS

Some medical problems can make the taking of herbal medicines unsafe. Patients with high blood pressure, thyroid disease, psychiatric disorders, Parkinson disease, enlarged prostate gland, diabetes mellitus, heart disease, epilepsy, glaucoma, blood clotting problems, or a history of stroke should check with their physicians before taking any herbal remedies.⁴⁵ Persons with a history of aspirin allergy may be at risk for adverse reactions if they take an herb that contains willow bark.⁴⁶

DRUG INTERACTIONS

Important drug interactions may occur between certain herbal products and conventional medications²¹ (Table E.4). A drug commonly involved with drug-herb interactions is warfarin.⁴⁷ The herb most commonly involved with such interactions is St. John's wort.⁴⁷ Markowitz and coworkers⁴⁸ in a study undertaken to evaluate the potential of St. John's wort to alter cytochrome P-450 enzymes, found that a 14-day course of the herbal product significantly induced the activity of CYP 3A4, as measured by changes in alprazolam pharmacokinetics. These investigators concluded that long-term administration of St. John's wort may result in diminished clinical

effectiveness or increased dosage requirements for all CYP 3A4 substrates, which represent about 50% of all marketed medications. By contrast, in another study, these workers found little evidence that garlic extracts would alter the disposition of coadministered medications metabolized by the CYP 3A4 pathway.⁴⁹

Patients who take aspirin, warfarin, ticlopidine, clopidogrel, or dipyridamole should not take *Ginkgo biloba* because bleeding may occur.⁴⁵ Patients who take an antidepressant should not take St. John's wort. Patients who are taking a decongestant or a stimulant drug and people who drink caffeinated beverages should not take ephedra. Persons who are taking a benzodiazepine, a barbiturate, an antipsychotic medication, or any medicine used to treat Parkinson disease should not take kava products.⁴⁵ It is important that patients notify their general practitioners if they are taking phytomedicines concurrently with conventional drugs, especially those with cardiac, diuretic, sedative, hypotensive, or other potentially dangerous properties.⁴⁴ Persons who are taking a prescription medicine should check with their physicians before taking any herbal health product.⁴⁵

Some patients with cancer have been found to use CAM to manage associated symptoms and in some cases as the primary treatment for their disease.⁵⁰⁻⁵⁴ Topical freeze-dried black raspberries have been reported to inhibit

TABLE E.3 Selected Herbal Medicines With Potentially Serious Adverse Effects

Product	Effect
Aristolochia	Nephrotoxicity Carcinogenicity
Chaparral	Cholestatic hepatitis
Comfrey	Acute and chronic hepatitis
Digitalis leaf	Arrhythmia
Ephedra	Hypertension Stroke Myocardial infarction
Germander	Acute and chronic hepatitis
Kava	Hepatitis
Khat	Tachycardia Psychosis
Kombucha	Hepatotoxicity Lactic acidosis
Mistletoe	Anaphylaxis
Skullcap	Seizures Acute and chronic hepatitis
St. John's wort	Photosensitivity Possible hypertension with tyramine-containing foods

TABLE E.4 Selected Natural Medicines That Potentiate or Interfere With Approved Drugs

Natural Medicine	Approved Drug
Ephedra	Theophylline (P) Antihypertensives (I) Corticosteroids (I)
Evening primrose	Anticoagulants (P) Antiplatelet agents (P) Low-molecular-weight heparins (P) Anticonvulsants (I)
Garlic	Aspirin (P) Clopidogrel (P) Ticlopidine (P)
Ginkgo leaf extract	Anticoagulants (P) Antiplatelet agents (P) Anticonvulsants (I)
Glucosamine <i>Panax ginseng</i>	Antidiabetic drugs (I) Anticoagulants (P) Diabetic agents (possible P) Nifedipine (P)
Saw palmetto	Hormone replacement therapies (P)
Soy	Estrogenic drugs (P)
St. John's wort	Antidepressants (P) HIV protease inhibitors (I) Cyclosporine (I)
Valerian	Sedatives (P)
Yohimbe	Antihypertensives (I)

I, Interferes; P, potentiates.

squamous cell carcinoma development when targeted to high-at-risk oral mucosa. These results support the translational role of freeze-dried black raspberries to prevent oral cancer development in humans.⁵⁵ Curcumin (diferuloylmethane) has been reported to modulate cell signaling pathways. It is a component of the golden spice turmeric. Numerous clinical trials have shown the safety and efficacy of curcumin. Positive effects have been demonstrated in patients with cancer, cardiovascular disease, arthritis, Crohn disease, ulcerative colitis, oral lichen planus, and other proinflammatory diseases. Curcumin has been shown to modulate signaling molecules. Formulations of curcumin include nanoparticles, liposomal encapsulation, emulsions, capsules, tablets and powder.^{56,57}

Various studies show that 30% to 60% of patients with cancer use some form of CAM in the management of symptoms and the cancer itself.^{52,54,58} These patients are at risk for interactions between the anticancer drugs and the CAM agents they are taking. These interactions may reduce the effectiveness of conventional anticancer drugs or increase the toxicity of these drugs. An oncology

database (OncoRx) is being developed to provide information regarding anticancer drugs and CAM interactions.⁵⁹

DENTAL IMPLICATIONS

A relatively small number of published papers describe the use of complementary and alternative medical systems for dental problems.^{38,60-77} Two of these papers report on the use of herbal products for the treatment of periodontal disease^{60,78} (Table E.5).

Acupuncture may be of some benefit in dentistry. In one study, patients with radiation-induced xerostomia demonstrated increased salivary flow rates both on objective and subjective measures.⁷⁹ However, the sample size was small at 12 patients with severe xerostomia. In another study, acupuncture was found to reduce gagging in orthodontic patients.⁸⁰ A third study found that acupuncture administered before dental treatment reduced the level of anxiety in patients with severe dental anxiety.⁸¹ A review of RCTs investigating the use of acupuncture for treatment of temporomandibular joint disorder

TABLE E.5 Effects of Homeopathic Techniques on Various Oral Conditions*

Oral Condition	Technique	Result	Recommendation
Orthodontic adjustment pain ⁶⁸	Acupuncture appeared to reduce the pain caused by orthodontic adjustment	Support for acupuncture	Appears to be safe adjunct for use in orthodontic patients: small study validation needed
Taste disturbance ⁷⁴	Zinc supplements did not improve unless deficient	No support for acupuncture	Idiopathic taste disorders could be improved with zinc
Pain: injection of local in children ⁷⁷	Acupuncture reduces pain	Reduces autonomic distress	Reported in a pragmatic crossover investigation
Ultrasound: trigger points in women with myofascial pain	Two-dimensional ultrasound	Ultrasound elastography imaging	Treated by acupuncture and electroacupuncture
Routine dental treatment: acupuncture ^{71,72,75}	Can help to alleviate acute and chronic facial pain	Can be helpful with pre- and postoperative dental pain	Can aid in the conventional treatment: TMD, facial pain, phobias, anxiety
Chronic periodontitis: herbal medicines ⁷⁰	Immunomodulators such as Septilin can improve periodontal health	Herbal medicine can be used with scaling and root planing	The combination can increase gingival index scores and decrease sulcus and pocket depths
Salivary flow: laser acupuncture effect on SS ⁶⁹	Small pilot study: effect of laser acupuncture on salivary flow rates	Resulted in increased flow rates in patients with SS	Results were stable over a 6-month follow-up period; validation is needed
Gag reflex: control with acupuncture ⁶⁷	Small pilot study: effect of acupuncture on reducing gag reflex	Reduced gag reflex in patients having dental impression taken	Results showed that acupuncture reduced gag reflex in these patients, but it was a small study; validation is needed
Antiplatelet and antigingivitis: herbal mouthwash ^{66†}	Study involved 100 patients with gingivitis: effect of herbal medicines on plaque and gingivitis scores	Reduced plaque and gingivitis scores	Results showed the herbal medicines reduced plaque and gingivitis scores and are an effective adjunct to mechanical therapy

*All of these studies were small pilot investigations with exception of one (effect of herbal mouthwash on plaque and gingivitis).⁶⁶ The conclusions of the pilot studies were that additional larger studies were needed to validate the findings.

†The herbal mouthwash contained Pilu, Bibhitaka, Nagavalli, *Gandhapura taila*, Ela, peppermint satva, and *Yavani satva*.⁶⁶ SS, Sjögren syndrome; TMD, temporomandibular joint disorder.

symptoms found moderate evidence that it was effective in alleviating symptoms.⁸²

INFORMATION FOR DENTISTS

Herbal remedies have the potential to affect the safety of invasive or prolonged dental procedures.⁸³ Excessive bleeding may occur with some of these medications.⁸³ Other herbal medicines may affect the cardiovascular system, rendering the patient more susceptible to cardiac arrhythmia and other cardiovascular complications.⁸⁴ Ginseng may cause hypoglycemia.⁸³ Chinese patients with cancer undergoing chemotherapy who were users of Chinese herbal medicine were found to have higher scores for mucositis.⁸⁵ ***It is important for the dentist to include a section in the patient's medical history on taking herbal medications and OTC drugs.*** Because most U.S. dental schools teach very little about the use, adverse effects, toxicity, and drug interactions associated with herbal remedies, dentists must find a way to become informed about these issues.

The single most important book for dentists who are dealing with patients who are having problems related to CAM or CIM is *Fundamentals of Complementary and Alternative Medicine*.⁷ This book is the most complete and updated reference available for dentists and other health care providers. The *Journal of Complementary and Integrative Medicine* is another resource that is available for health care professionals.⁸⁶ The *Mayo Clinic Book of Alternative Medicine*,⁸⁷ although it was published in 2010, has information that is useful in managing these patients. Other references that may be helpful include the *Physicians' Desk Reference for Herbal Medicines* and the *Physicians' Desk Reference for Nonprescription Drugs, Dietary Supplements, and Herbs*.

The National Institutes of Health has a website⁸⁸ that deals with complementary and integrative health issues. This site may be useful for dentists wanting more information regarding the management of patients with these problems. In 2015, U.S. government agencies began considering greater regulation of both homeopathic drugs and the advertising of such products. These actions came after more than a century of missed opportunities to regulate homeopathic medicines.⁸⁹ Other countries have similar access to information regarding the management of these patients. For example, Brazil has had regulation of herbal products since 2000. Efficacy and safety are demonstrated by literature data, by clinical and preclinical tests, and to some extent by tradition of use.⁹⁰

Dentists should use only treatment procedures that have been established as effective and involving minimal risk. Because clinical trials have shown some alternative and complementary medicine treatments to be effective and safe, those treatments may be incorporated into conventional medicine and dentistry.⁹¹ A dentist may find that a medically compromised patient is taking an herbal remedy that is potentially harmful. This should

be discussed with the patient, who should then be referred to his or her primary care physician for evaluation and treatment.

REFERENCES

1. Micozzi M. *Characteristics of Complementary and Alternative Medicine. Fundamentals of Complementary and Alternative Medicine*. 5th ed. St. Louis: Saunders (Elsevier); 2015:3-12.
2. Ergil KV, Ergil MC. Classical Acupuncture. In: Micozzi M, ed. *Fundamentals of Complementary and Alternative Medicine*. St. Louis, MO: Saunders (Elsevier); 2015:508-543.
3. Staples JK. Yoga. In: Micozzi MS, ed. *Fundamentals of Complementary and Alternative Medicine*. St. Louis, MO: Saunders (Elsevier); 2015:332-343.
4. Nolan P, Goodill SW. Creative and Expressive Arts Therapies. In: Micozzi MS, ed. *Fundamentals of Complementary and Alternative Medicine*. 5th ed. St. Louis: Saunders (Elsevier); 2015: 157-174.
5. Little JW. Complementary and alternative medicine: impact on dentistry. *Oral Surg Oral Med Oral Pathol Oral Radiol Endod*. 2004;98(2):137-145.
6. Straus SE. Complementary and alternative medicine. In: Goldman L, Ausiello D, eds. *Cecil Textbook of Medicine*. 22nd ed. Philadelphia: Saunders; 2004:170-174.
7. Micozzi M. *Fundamentals of Complementary and Alternative Medicine*. 5th ed. St. Louis: Saunders; 2015.
8. Ergil KV. Traditional Medicine of China and East Asia. In: Micozzi MS, ed. *Fundamentals of Complementary and Alternative Medicine*. St. Louis, MO: Saunders (Elsevier); 2015:477-507.
9. Micozzi MS. Traditional medicines of India: Ayurveda and Siddha. In: Micozzi MS, ed. *Fundamentals of Complementary and Alternative Medicine*. St. Louis, MO: Saunders (Elsevier); 2015:545-566.
10. Voss RW, Moerman DE, Micozzi MS. Native North American healing and herbal remedies. In: Micozzi MS, ed. *Fundamentals of Complementary and Alternative Medicine*. St. Louis, MO: Saunders (Elsevier); 2015:623-638.
11. Spelman K. Ecological pharmacy: molecular biology to systems theory. In: Micozzi MS, ed. *Fundamentals of Complementary and Alternative Medicine*. St. Louis, MO: Saunders (Elsevier); 2015:455-476.
12. Jones JM. Osteopathy. In: Micozzi MS, ed. *Fundamentals of Complementary and Alternative Medicine*. St. Louis, MO: Saunders (Elsevier); 2015:275-299.
13. Redwood D. Chiropractic. In: Micozzi MS, ed. *Fundamentals of Complementary and Alternative Medicine*. St. Louis, MO: Saunders (Elsevier); 2015:300-325.
14. Micozzi MS, Jawer MA. Mind-body therapies, stress and psychometrics. In: Micozzi MS, ed. *Fundamentals of Complementary and Alternative Medicine*. St. Louis, MO: Saunders (Elsevier); 2015:114-140.

15. Ives JA, Jonas WB. Energy medicine. In: Micozzi MS, ed. *Fundamentals of Complementary and Alternative Medicine*. 5th ed. St. Louis: Saunders (Elsevier); 2015:197-212.
16. Jeter PE, Slutsky J, Singh N, et al. Yoga as a therapeutic intervention: a bibliometric analysis of published research studies from 1967 to 2013. *J Altern Complement Med*. 2015;21(10):586-592.
17. Wells RE, Phillips RS, Schachter SC, et al. Complementary and alternative medicine use among US adults with common neurological conditions. *J Neurol*. 2010;257(11):1822-1831.
18. Ernst E. Homeopathy: what does the “best” evidence tell us? *Med J Aust*. 2010;192(8):458-460.
19. Barnes J. Consumer and pharmacist perspectives. In: Ernst E, ed. *Herbal Medicine: A Concise Overview for Professionals*. Oxford: Butterworth & Heinemann; 2000:19-33.
20. Murray M, Pizzorno J. Botanical medicine—a modern perspective. In: Pizzorno J, Murray M, eds. *Textbook of natural medicine*. St. Louis: Churchill Livingstone; 2006:327-339.
21. Pizzorno JEJ, Snider P. Contemporary naturopathic medicine. In: Micozzi MS, ed. *Fundamentals of Complementary and Alternative Medicine*. St. Louis, MO: Saunders (Elsevier); 2015:366-386.
22. Eisenberg DM, Davis RB, Ettner SL, et al. Trends in alternative medicine use in the United States, 1990-1997: results of a follow-up national survey. *JAMA*. 1998;280(18):1569-1575.
23. Eldin S, Dunford A. *Herbal Medicine in Primary Care*. Oxford: Butterworth & Heinemann; 1999.
24. Zick SM, Blume A, Aaronson KD. The prevalence and pattern of complementary and alternative supplement use in individuals with chronic heart failure. *J Card Fail*. 2005;11(8):586-589.
25. Xiong X, Wang P, Zhang Y, et al. Effects of traditional Chinese patent medicine on essential hypertension: a systematic review. *Medicine (Baltimore)*. 2015;94(5):e442.
26. Liu LY, Feng B, Chen J, et al. Herbal medicine for hospitalized patients with severe depressive episode: a retrospective controlled study. *J Affect Disord*. 2015;170:71-77.
27. Ernst E. Herbal medicine in the treatment of rheumatic diseases. *Rheum Dis Clin North Am*. 2011;37(1):95-102.
28. Zuzak TJ, Zuzak-Siegrist I, Rist L, et al. Medicinal systems of complementary and alternative medicine: a cross-sectional survey at a pediatric emergency department. *J Altern Complement Med*. 2010;16(4):473-479.
29. Nahas R, Balla A. Complementary and alternative medicine for prevention and treatment of the common cold. *Can Fam Physician*. 2011;57(1):31-36.
30. Herman PM, Craig BM, Caspi O. Is complementary and alternative medicine (CAM) cost-effective? A systematic review. *BMC Complement Altern Med*. 2005;5:11.
31. Klepser TB, Doucette WR, Horton MR, et al. Assessment of patients’ perceptions and beliefs regarding herbal therapies. *Pharmacotherapy*. 2000;20(1):83-87.
32. Pharand C, Ackman ML, Jackevicius CA, et al. Use of OTC and herbal products in patients with cardiovascular disease. *Ann Pharmacother*. 2003;37(6):899-904.
33. Abebe W, Herman W, Konzelman J. Herbal supplement use among adult dental patients in a USA dental school clinic: prevalence, patient demographics, and clinical implications. *Oral Surg Oral Med Oral Pathol Oral Radiol Endod*. 2011;111(3):320-325.
34. Ernst E, Pittler MH. Herbal medicine. *Med Clin North Am*. 2002;86(1):149-161.
35. M. M. Translation. From conventional medicine. In: Micozzi M, ed. *Fundamentals of Complementary and Alternative Medicine*. 5th ed. St. Louis: Saunders (Elsevier); 2015:13-21.
36. Ernst E, Pittler MH. Ginkgo biloba for dementia: a systematic review of double-blind placebo-controlled trials. *Clin Drug Invest*. 1999;17:301-308.
37. Pittler MH, Ernst E. Ginkgo biloba extract for the treatment of intermittent claudication: a meta-analysis of randomized trials. *Am J Med*. 2000;108(4):276-281.
38. Prabhakar AR, Karuna YM, Yavagal C, et al. Cavity disinfection in minimally invasive dentistry - comparative evaluation of Aloe vera and propolis: A randomized clinical trial. *Contemp Clin Dent*. 2015;6(suppl 1):S24-S31.
39. Vogler BK, Pittler MH, Ernst E. The efficacy of ginseng. A systematic review of randomised clinical trials. *Eur J Clin Pharmacol*. 1999;55(8):567-575.
40. Ernst E. The efficacy of herbal medicine—an overview. *Fundam Clin Pharmacol*. 2005;19(4):405-409.
41. Buderiri D, Li Wan Po A, Dornan J. Is evening primrose oil of value in the treatment of premenstrual syndrome? *Controlled Clin Trials*. 1996;17:60-68.
42. Stevinson C, Pittler MH, Ernst E. Garlic for treating hypercholesterolemia. A meta-analysis of randomized clinical trials. *Ann Intern Med*. 2000;133(6):420-429.
43. Clark CE, Arnold E, Lasserson TJ, et al. Herbal interventions for chronic asthma in adults and children: a systematic review and meta-analysis. *Prim Care Respir J*. 2010;19(4):307-314.
44. Halkes S. Safety issues in phytotherapy. In: Ernst E, ed. *Herbal Medicine: A Concise Overview for Professionals*. Oxford: Butterworth & Heinemann; 2000:82-100.
45. Jeske A. *Mosby’s Dental Drug Reference*. 11th ed. St. Louis, MO: Mosby (Elsevier); 2014:xlvii-lxx.
46. Boullata JI, McDonnell PJ, Oliva CD. Anaphylactic reaction to a dietary supplement containing willow bark. *Ann Pharmacother*. 2003;37(6):832-835.
47. Brazier NC, Levine MA. Drug-herb interaction among commonly used conventional medicines: a compendium for health care professionals. *Am J Ther*. 2003;10(3):163-169.
48. Markowitz JS, Donovan JL, DeVane CL, et al. Effect of St John’s wort on drug metabolism by induction of cytochrome P450 3A4 enzyme. *JAMA*. 2003;290(11):1500-1504.
49. Markowitz JS, DeVane CL, Chavin KD, et al. Effects of garlic (*Allium sativum* L.) supplementation on cytochrome P450 2D6 and 3A4 activity in healthy volunteers. *Clin Pharmacol Ther*. 2003;74(2):170-177.

50. Bell RM. A review of complementary and alternative medicine practices among cancer survivors. *Clin J Oncol Nurs.* 2010;14(3):365-370.
51. Bishop FL, Rea A, Lewith H, et al. Complementary medicine use by men with prostate cancer: a systematic review of prevalence studies. *Prostate Cancer Prostatic Dis.* 2011;14(1):1-13.
52. Hietala M, Henningson M, Ingvar C, et al. Natural remedy use in a prospective cohort of breast cancer patients in southern Sweden. *Acta Oncol.* 2011;50(1):134-143.
53. Olaku O, White JD. Herbal therapy use by cancer patients: a literature review on case reports. *Eur J Cancer.* 2011;47(4):508-514.
54. Kim W, Lee WB, Lee J, et al. Traditional herbal medicine as adjunctive therapy for nasopharyngeal cancer: a systematic review and meta-analysis. *Integr Cancer Ther.* 2015;14(3):212-220.
55. Warner BM, Casto BC, Knobloch TJ, et al. Chemoprevention of oral cancer by topical application of black raspberries on high at-risk mucosa. *Oral Surg Oral Med Oral Pathol Oral Radiol.* 2014;118(6):674-683.
56. Ravindran J, Prasad S, Aggarwal BB. Curcumin and cancer cells: how many ways can curry kill tumor cells selectively? *AAPS J.* 2009;11(3):495-510.
57. Gupta SC, Patchva S, Aggarwal BB. Therapeutic roles of curcumin: lessons learned from clinical trials. *AAPS J.* 2013;15(1):195-218.
58. Rausch S, et al. Health behaviors among cancer survivors receiving screening mammography. *Am J Clin Oncol.* 2011.
59. Yap KY, Kuo EY, Lee JJ, et al. An onco-informatics database for anticancer drug interactions with complementary and alternative medicines used in cancer treatment and supportive care: an overview of the OncoRx project. *Support Care Cancer.* 2010;18(7):883-891.
60. Amrutesh S. Dentistry and ayurveda-1. *Indian J Dent Res.* 2003;14(1):1-5.
61. Shaw D. Unethical aspects of homeopathic dentistry. *Br Dent J.* 2011;209:493-496.
62. Brailo V, Bosnjak A, Boras VV, et al. Laser acupuncture in the treatment of burning mouth syndrome: a pilot study. *Acupunct Med.* 2013;31(4):453-454.
63. Gordon D, Heimberg RG, Tellez M, et al. A critical review of approaches to the treatment of dental anxiety in adults. *J Anxiety Disord.* 2013;27(4):365-378.
64. Kumar G, Jalaluddin M, Rout P, et al. Emerging trends of herbal care in dentistry. *J Clin Diagn Res.* 2013;7(8):1827-1829.
65. Sardella A, Lodi G, Tarozzi M, et al. Acupuncture and burning mouth syndrome: a pilot study. *Pain Pract.* 2013;13(8):627-632.
66. Aspalli S, Shetty VS, Devarathnamma MV, et al. Evaluation of antiplaque and antigingivitis effect of herbal mouthwash in treatment of plaque induced gingivitis: a randomized, clinical trial. *J Indian Soc Periodontol.* 2014;18(1):48-52.
67. Bilello G, Fregapane A. Gag reflex control through acupuncture: a case series. *Acupunct Med.* 2014;32(1):24-27.
68. Boleta-Ceranto Dde C, de Souza RS, Silverio-Lopes S, et al. Orthodontic post-adjustment pain control with acupuncture. *Dental Press J Orthod.* 2014;19(4):100-106.
69. Cafaro A, Arduino PG, Gambino A, et al. Effect of laser acupuncture on salivary flow rate in patients with Sjogren's syndrome. *Lasers Med Sci.* 2014.
70. Deore GD, Gurav AN, Patil R, et al. Herbal anti-inflammatory immunomodulators as host modulators in chronic periodontitis patients: a randomised, double-blind, placebo-controlled, clinical trial. *J Periodontal Implant Sci.* 2014;44(2):71-78.
71. Grillo CM, Wada RS, da Luz Rosario de Sousa M. Acupuncture in the management of acute dental pain. *J Acupunct Meridian Stud.* 2014;7(2):65-70.
72. Gupta D, Dalai DR, Swapnadeep, et al. Acupuncture (zhen jiu) - an emerging adjunct in routine oral care. *J Tradit Complement Med.* 2014;4(4):218-223.
73. Hongal S, Torwane NA, Pankaj G, et al. Role of unani system of medicine in management of orofacial diseases: a review. *J Clin Diagn Res.* 2014;8(10):ZE12-ZE15.
74. Nagraj SK, Naresh S, Srinivas K, et al. Interventions for the management of taste disturbances. *Cochrane Database Syst Rev.* 2014;(11):CD010470.
75. Naik PN, Kiran RA, Yalamanchal S, et al. Acupuncture: an alternative therapy in dentistry and its possible applications. *Med Acupunct.* 2014;26(6):308-314.
76. Shanbhag VK. Triphala in prevention of dental caries and as an antimicrobial in oral cavity- A review. *Infect Disord Drug Targets.* 2015.
77. Usichenko TI, Wolters P, Anders EF, et al. Acupuncture reduces pain and autonomic distress during injection of local anesthetic in children - a pragmatic crossover investigation. *Clin J Pain.* 2015.
78. Sastravaha G, Yotnuengnit P, Booncong P, et al. Adjunctive periodontal treatment with *Centella asiatica* and *Punica granatum* extracts. A preliminary study. *J Int Acad Periodontol.* 2003;5(4):106-115.
79. Braga FP, Sugaya NN, Hirota SK, et al. The effect of acupuncture on salivary flow rates in patients with radiation-induced xerostomia. *Minerva Stomatol.* 2008;57(7-8):343-348.
80. Sari E, Sari T. The role of acupuncture in the treatment of orthodontic patients with a gagging reflex: a pilot study. *Br Dent J.* 2010;208(10):E19.
81. Rosted P, Bundgaard M, Gordon S, et al. Acupuncture in the management of anxiety related to dental treatment: a case series. *Acupunct Med.* 2010;28(1):3-5.
82. Cho SH, Whang WW. Acupuncture for temporomandibular disorders: a systematic review. *J Orofac Pain.* 2010;24(2):152-162.
83. Ang-Lee MK, Moss J, Yuan CS. Herbal medicines and perioperative care. *JAMA.* 2001;286(2):208-216.
84. Goldstein BH. Unconventional dentistry: Part III. Legal and regulatory issues. *J Can Dent Assoc.* 2000;66(9):503-506.
85. Chan CW, Chang AM, Molassiotis A, et al. Oral complications in Chinese cancer patients undergoing chemotherapy. *Support Care Cancer.* 2003;11(1):48-55.

86. Lowe GM, Gana K, Rahman K. Dietary supplementation with green tea extract promotes enhanced human leukocyte activity. *J Complement Integr Med.* 2015;12(4):277-282.
87. Clinic M. *Mayo Clinic Book of Alternative Medicine.* 2nd ed. Birmingham, AL: Oxmoor House; 2010.
88. National Center for Complementary and Integrative Health Washington D.C. National Institutes of Health; 2015. <https://nccih.nih.gov/>. Accessed 21 November 2015.
89. Podolsky SH, Kesselheim AS. Regulating homeopathic products - a century of dilute interest. *N Engl J Med.* 2016;374(3):201-203.
90. (ANVISA) NHTA Herbal Medicines Regulation in Brazil. National Health Surveillance Agency; 2008. www.anvisa.gov.br. Accessed 1 December 2015.
91. Miller FG, Emanuel EJ, Rosenstein DL, et al. Ethical issues concerning research in complementary and alternative medicine. *JAMA.* 2004;291(5):599-604.

This page intentionally left blank

Page numbers followed by “*f*” indicate figures, “*t*” indicate tables, and “*b*” indicate boxes.

- A**
- Abdomen, allergic rash, 340*f*
- Abelson leukemia virus gene, 409–410
- Acetaminophen, drug interactions of, 639–644
- Acid-blocking drugs, 181
- Acquired angioedema, 333
- Acquired bleeding disorders, 428–456
- anticoagulant drugs for, 441–443
- antiplatelet drugs for, 443
- classifications of, 429*b*
- clinical presentation of, 434–438
- coagulation phase, 431–432
- definition of, 428
- dental management with, 444–453
- history and symptoms in, 445–446
- medical considerations in, 447–452
- patient identification in, 444–445
- physical examination in, 446–447
- screening laboratory tests for, 447
- surgical procedures for, 447
- treatment planning modifications for, 452
- diagnostic tests for, 437–438
- epidemiology of, 428
- etiology of, 428–434
- fibrinolytic phase of, 432–434
- laboratory and diagnostic findings of, 434–438
- medical management of, 438–443
- oral manifestations in, 452–453
- pathophysiology of, 430–434
- platelet phase, 430–431
- screening tests for, 436–437
- signs and symptoms of, 434
- treatment of, 438*t*
- vascular phase, 430
- Acquired cushingoid facies, 10*f*
- Acquired hemophilia, 429
- Acquired hypothyroidism, 279
- Acquired immunodeficiency syndrome (AIDS), 309–329
- see also* Human immunodeficiency virus (HIV) infection
- angular cheilitis in, 323*f*
- chemoprophylaxis for, 320
- clinical presentation of, 316–318
- complications of, 314–316
- critical complications of, 309
- defining conditions of, 310*b*
- definition of, 309
- dental care for, 321
- dental management of, 320–328
- considerations in, 327*b*
- erythematous lesions in, 323*f*
- etiology of, 310–316
- head, neck, and oral lesions associated with, 325*t*
- health care personnel, risk of transmission from, 322
- highly active antiretroviral therapy (HAART) and, 310
- implications of, 309
- incidence of, 309–310
- invasive dental procedures, planning for, 321
- Acquired immunodeficiency syndrome (AIDS) (*Continued*)
- laboratory and diagnostic findings of, 317–318
- medical management of, 318–320
- oral complications and manifestations of, 322–328
- palate lesions in, 322*f*, 324*f*
- pathophysiology of, 314–316
- patient characteristics in, 312*t*–313*t*
- periodontal disease and, 321–322
- prevalence of, 309–310
- risk for, 320
- signs and symptoms of, 316–317
- Acromegaly, 10*f*
- Acrophobia, 546*f*
- Actinic cheilitis, 629
- Activated partial thromboplastin time (aPTT), 206–207, 436, 458
- Activated protein C (APC), 430
- Active tuberculosis, chemotherapy, effectiveness, 119–120
- Acupuncture, 645
- Acute adrenal insufficiency, 599–600
- Acute coronary syndrome (ACS), 55–57
- Acute hemarthrosis, knee, 459*f*
- Acute hepatitis, serologic diagnosis of, 154*t*
- Acute hepatitis A, serologic course of, 155*f*
- Acute hepatitis B, serologic course of, 156*f*
- Acute hepatitis C, serologic course of, 158*f*
- Acute ischemic stroke (AIS)
- Penumbra stroke system in, 519
- treatment strategies for, 519
- Acute leukemias
- chronic leukemia, comparison, 413*t*
- classification of, clinical, cytologic and immunologic abnormalities, 406*t*
- clinical factors in, 410*t*
- Acute lymphoblastic leukemia, peripheral blood smear of, 407*f*
- Acute lymphoid leukemia, 405–409
- chemotherapy for, 407
- clinical presentation of, 406–407
- definition of, 405
- epidemiology of, 405–406
- etiology of, 406
- laboratory findings of, 406–407
- medical management of, 407–409
- oral manifestations of, 408–409
- pathophysiology and complications of, 406
- signs and symptoms of, 406
- Acute myelogenous leukemia, 404–405
- clinical presentation of, 404–405
- complications of, 404
- definition of, 404
- epidemiology of, 404
- etiology of, 404
- laboratory findings of, 405
- oral mucositis in, undergoing myeloablative allogeneic hematopoietic transplantation, 379*f*
- pathophysiology of, 404
- signs and symptoms of, 404–405
- Acute myeloid leukemia, 405*f*
- extramedullary relapse of, after hematopoietic cell transplantation, 384*f*
- gingival enlargement in, 423*f*
- presenting as bleeding and ecchymosis of tongue, 405*f*
- Acute myocardial infarction, medical management of, 61*b*
- Acute oral infections, dental management of, 250*b*
- Acute pulmonary edema, 88
- Acute stress disorder, 549
- Acute viral hepatitis, 151
- agents for, 152*t*–153*t*
- Adalimumab, 185
- Addiction, 581
- neurobiology of, complexity, 583–584
- Addison disease, 258
- bronzing of skin in, 259*f*
- Adenosine diphosphate (ADP), 430
- Adenosine triphosphatase (ATPase), sarcoplasmic reticulum, alteration of, 270–271
- Adolescents
- blood pressure
- classification of, 39*t*
- 95th percentile of, 40*t*
- HIV infection, Centers for Disease Control and Prevention staging of, 317*b*
- Adrenal androgens, 257
- Adrenal cortex, zones of, 255
- Adrenal crisis, 259, 262
- Adrenal gland, structure of, 255*f*
- Adrenal insufficiency, 255–267
- blood pressure, monitoring of, 263
- categories of, 258
- clinical presentation of, 259–260
- complications of, 258–259
- corticosteroids, topical application of, 259
- definition of, 258
- dental management of, 262–265
- considerations in, 264*b*
- epidemiology of, 258
- etiology of, 258
- laboratory and diagnostic findings of, 260
- medical management of, 260–262
- mineralocorticoids, usage, 257
- oral manifestations of, 265
- pathophysiology of, 258–259
- signs and symptoms of, 259–260
- supplemental corticosteroids, recommendations for, 263
- surgery, steroid supplementation, recommendations for, 261*t*
- β-adrenergic agonists, for asthma, 112
- β-adrenergic bronchodilators, for chronic obstructive pulmonary disease (COPD) and asthma, 106*t*–107*t*
- Adrenocorticotrophic hormone (ACTH)
- production of, 256
- secretion of, 256

- Adults
 blood pressure, classification of, *39t*
 HIV infection, Centers for Disease Control and Prevention staging of, *317b*
- Advanced alcoholic liver disease, features, *174b*
- Advanced atheromatous plaques, *56f*
- Advanced cardiac life support (ACLS) training, *597*
- Agoraphobia, *546*
- Agranulocytosis, *579f*
- Airflow obstruction, asthma and, *109–111*
- Airway, anatomic narrowing, *141–142*
- Alcohol, *588–589*
 behavioral effects of, *588*
 binge drinking, *583*
 heavy intake of, *588*
 physiologic effects of, *588*
 problems, brief interventions, *590–591*
 withdrawal, *589*
- Alcohol abuse, *581–595*
 addiction/dependence, neurobiology (complexity), *583–584*
 brief intervention for, *591*
 clinical presentation of, *584–589*
 definitions of, *581*
 dental management of, *589–593, 590b*
 epidemiology of, *581–584*
 etiology of, *583–584*
 medical considerations for, *589–593*
 medical history, *591*
 medical management of, *584–589*
 oral complications and manifestations of, *593*
 problem drinking, prevalence of, *583*
 referral for, *591*
 screening for, *591, 591f*
 treatment for, *591–593*
 planning considerations for, *593*
- Alcohol dependence
 dental management of, *590b*
 DSM-IV definition of, *588–589*
 treatment for, *589*
 treatment of, *591–592*
- Alcohol use, *8*
- Alcohol use disorder (AUD), *583*
- Alcohol Use Disorders Identification Test (AUDIT) self-report questionnaire, *591, 592t*
- Alcoholic hepatitis, *169*
- Alcoholic liver disease, *169–174*
 advanced, features, *174b*
 clinical presentation of, *171*
 definition of, *169*
 dental management of, *172–174*
 antibiotics, *172*
 bleeding, *172–173*
 drug considerations, *173*
 oral complication and manifestations, *173–174*
 treatment planning considerations, *173*
 laboratory findings of, *171*
 medical management of, *171–172*
 pathophysiology and complications of, *169–171*
- Alcoholism, *581*
 painless enlargement of parotid glands associated with, *171f*
 parotid gland enlargement associated with, *591f*
 spider angiomas as sign of, *591f*
- Aldosterone
 as adrenal cortex hormone, *258*
 secretion, regulation of, *257f*
- Alkaline phosphatase, *164*
- Allergens, *330–331*
- Allergic asthma (extrinsic asthma), *109*
 processes involve in, *110f*
- Allergic dermatitis, *340f*
- Allergic reaction, signs and symptoms of, *335b*
- Allergy(ies), *6, 330–344*
 adverse drug reactions, *335b*
 anaphylaxis, *332*
 cellular immune system and, *333–334*
 complications of, *331–334*
 dental management of, *334–341*
 drugs as cause of, *330*
 epidemiology of, *330*
 etiology of, *330–331*
 humoral immune system and, *331–333*
 laboratory and diagnostic findings of, *334*
 local anesthetics, dental management of, *336b*
 medical considerations for, *334–338*
 medical management of, *334*
 oral complications and manifestations of, *339–341*
 pathophysiology of, *331–334*
 prevalence of, *330*
 skin testing for, *337*
 treatment planning modifications for, *339*
- Allogeneic hematopoietic cell transplantation, orofacial granulomatosis-like lesions after, *381f*
- Alternate-day regimen, *261–262*
- Alternative medical systems, definition of, *645*
- Alternative medicine, *645*
- Alzheimer disease, *527–532*
 categories of, *528*
 characterization of, *527*
 cholinesterase inhibitors for, *528–529*
 clinical presentation of, *527–528*
 complications of, *527*
 dental management of, *529–532*
 considerations in, *529b*
 diagnosis of, brain biopsy or autopsy for, *528*
 epidemiology of, *527*
 general description of, *527*
 laboratory and diagnostic findings of, *528*
 medical management of, *528–529*
 memantine (Axura) for, *529*
 no cure for, *528–529*
 oral complications and manifestations of, *531–532*
 pathophysiology of, *527*
 prevalence of, *527*
 signs and symptoms of, *527–528*
- Amikacin (Amikin), *123t*
- 5-aminosalicylic acid (5-ASA), *185*
- Aminosalicylic acid (Sodium P.A.S., Teebacin), *123t*
- Aminotransferase, *164*
- Amphetamines, *587–588*
 analogues of, *588*
- ANA test, *358*
- Anal-genital intercourse, gonorrhea and, *212*
- Analgesics, *625*
 allergic reaction to, *338*
 drug interactions of, *639–644*
- Anaphylactic reactions, human, causes of, *331b*
- Anaphylaxis, *332, 343*
 management, *343b*
 signs and symptoms of, *342f*
- Anatomic narrowing, airway, *141–142*
- Androgen-related disorders, *260*
- Anemia, *5, 390, 434*
 clinical presentation of, *392–393*
 complications of, *392*
 dental management with, *396–398*
 diagnosis of, *395*
 epidemiology of, *391*
 etiology of, *391*
 frequencies of, *391f*
 laboratory and diagnostic findings of, *393–395, 394t*
 medical management of, *395–396*
 oral manifestations of, *398–399*
 pallor of the hand in, *396f*
 pathophysiology of, *392*
 signs and symptoms of, *392–393*
 treatment planning modifications for, *398*
 types of, *390–391, 391t*
- Anesthetics, drug interactions of, *639–644*
- Aneurysm, of middle cerebral artery, *517f*
- Angina, management of, drugs for, *59t*
- Angina pectoris, *4, 56–57, 603–604*
 medical management of, *58–61*
 stable, medical management of, *58b*
- Angioedema, *332, 342–343*
 acquired, *333*
 drug-induced, *333*
 hereditary, *333, 339*
 of upper lip, *339f*
- Angioplasty, *5*
- Angiotensin receptor blockers (ARBs), *42*
- Angiotensin-converting enzyme (ACE) inhibitors, *42, 60*
- Angular cheilitis
 in acquired immunodeficiency syndrome (AIDS), *323f*
 and cheilosis
 clinical description of, *628*
 etiology of, *628*
 treatment rationale for, *628–629*
- Ankylosing spondylitis, *345*
- Anogenital warts, *223*
- Centers for Disease Control and Prevention regimen recommendation for, *225b*
- Anorexia nervosa, *550–551, 556f*
 clinical findings of, *550t*
 DSM-IV diagnostic criteria for, *552b*
 epidemiology of, *550t*
 long-term follow-up evaluation of, *553*
 sudden death in, *552–553*
 treatment, weight gain in, *551–552*
- Anterior mandible, lytic lesion in, with hyperparathyroidism, *196f*
- Anterior open bite, progressive bilateral condylar resorption, *355f*
- Antiarrhythmic drugs, *4–5, 75*
- Antiasthmatic drugs, *112, 113f*
- Antibiotic prophylaxis, *27–29, 28t*
 advocacy, *34b*
 American Heart Association (AHA) recommendations for, *27*
 dental procedures, recommendation, *31, 31b*
 efficacy of, *29*
 patient receipt, recommendation, *30*
 regimens, *31–32, 32t*
- Antibiotics
 drug interactions of, *639–644*
 pregnancy usage, *295*
- Anticholinergic antipsychotic drugs, adverse effects of, *574*
- Anticholinergic bronchodilators, for chronic obstructive pulmonary disease (COPD) and asthma, *106t–107t*

- Anticoagulant drugs, 441–443, 444*t*
 site of action of, 441*f*
- Antidepressants
 adverse effects of, 571*t*
 drug interactions of, 571*t*, 639–644
 group of, 566*t*
 medications, 570–572
 second-generation, 572
- Antifungals
 drug interactions of, 639–644
 topical, 628
- Antigens, 330–331
- Antihistamines
 allergic response to, 330
 second- and third-generation, 334*t*
- Antiinflammatory drugs, for chronic
 obstructive pulmonary disease (COPD)
 and asthma, 106*t*–107*t*
- Antimanic treatment, electroconvulsive
 therapy as, 566
- Antineoplastic agents, and radiation
 therapy, management of patients
 receiving, 635–636
- Antiplatelet therapy, 448–449, 448*t*
 with aspirin, 60
- Antipsychotic medications, 573*t*
- Antipsychotic (neuroleptic) drugs, 573–575
 adverse effects of, 574, 578
 adverse reactions of, 574*t*
 categorization of, 573
 drug interactions of, 575, 575*t*, 578
 extrapyramidal adverse effects of, 574
 for malignant neuroleptic syndrome, 575
 tardive dyskinesia and, 574
- Antiretroviral therapy (ART), 318–320
- Antisclerostin antibodies, sites of action of,
 301*f*
- Antisecretory drugs, 180*t*
- Antithrombin III, inherited quantitative or
 qualitative deficiency of, 471
- Antithrombotic agents, 444*t*, 448*t*
 antidotes for, 445*t*
- Antithrombotic therapy, 440–441
 physiologic, 434*b*
- Antithyroid drugs, side effects of, 276*b*
- Antituberculosis drugs, 123*t*
- Antiviral therapy, 624
- Anxiety, 544
 diagnostic criteria of, 547*t*
 drug interaction problem, 639–644
 medical management for, 554
 physiologic reactions to, 546
 reduction, 17
 signs and symptoms of, 547*t*
 states of, 546
 treatment of, drugs for, 549*t*
 understanding of, 544
- Anxiety disorders, 544–550
 buspirone for, 553
 classification of, 545*b*
 clinical presentation of, 546–549
 definition of, 544–546
 dental management of, 554
 considerations in, 555*b*
 diazepam for, 553
 epidemiology of, 545
 etiology of, 545–546
 generalized, 547–548, 547*t*
 medical management of, 549–550
 drug interactions, 558
 patterns of, 544
 prevalence of, 545
 systemic desensitization for, 549
 treatment for, 549
 planning considerations for, 558
- Anxiolytics, pregnancy usage, 296–297
- Anxious patients, dental management
 considerations in, 555*b*
- Aorta, advanced atheromatous plaques, 56*f*
- Aphthae
 major, 626
 minor, 626
- Aphthous stomatitis
 clinical description of, 626
 etiology of, 626
 treatment rationale for, 626–627
- Aphthous-like ulceration, of labial mucosa,
 381*f*
- Apixaban (Eliquis), for cardiac
 arrhythmias, 80–82
- Aplastic anemia, 391, 399*f*
 bleeding with, 398
- Apnea-hypopnea index (AHI), 143
- ARCHITECT HIV Ag/Ab Combo assay,
 317–318
- Argatroban, 442
- Arrhythmias, 4–5
 treatment of, drugs for, 76*t*
- Arterial access, catheters for, 34*t*
- Arterial blood gas measurement, for
 COPD, 103
- Arterial endothelium, chronic minimal
 injury to, 54
- Arterial wall changes, evolution of, 55*f*
- Arteriovenous fistula
 infection of, 201
 site of, 200*f*
- Arthritis, 7, 345
- Arthritis mutilans, 363
- Artificial heart valve, 4
- Arts therapies, 645
- Ascites, 91*f*
- Asian ginseng, 646
- Aspart, 239
- Aspiration, foreign object, 601
- Aspirin, 431
 allergic reaction to, 338
 for angina, 60
 asthma and, 109
 drug interactions of, 639–644
- Asthma, 6, 108–116
 allergic or extrinsic, processes involve in,
 110*f*
 antiasthmatic drug selection, 112
 aspirin, allergic reaction, 338
 classification of, 111–112, 112*b*
 clinical presentation of, 111
 complications of, 109–111
 dental management of, 113–116
 considerations for, 114*b*
 epidemiology of, 108–109
 etiology of, 109
 laboratory and diagnostic findings of,
 111–112
 medical management of, 112–113
 morbidity and, 111
 oral complications and manifestations of,
 115–116
 outpatient management of, drugs for,
 106*t*–107*t*
 pathophysiology of, 109–111
 signs and symptoms of, 111
- Asthma, drug interaction problem,
 639–644
- Asthma attack, 115
- Asymptomatic carotid stenosis, 516
- Atheroma formation, 54–55
- Atherosclerosis, 53–54, 440
 as focal disease, 55
 macrovascular disease, 234
- Atherosclerotic process, outcome of, 55
- Atopy, 332
- Atrial fibrillation (AF), 70, 73
 drug interaction problem, 639–644
- Atrial flutter, 73
- Atrial Premature Beats (APBs), 73
- Atrial rhythm, disturbances of, 73
- Atrial tachycardias, 73
- Atrioventricular (AV) block, 73–74
- Atrioventricular (AV) node, 70
- Atrioventricular junction, tachycardias
 involving, 73
- Atrophic kidneys, 195*f*
- Atypical antidepressant agents, 572
- Atypical antipsychotic drugs, 574–575
- Auscultatory gap, 13–14
- Auscultatory method, 42
- Auto-adjusting positive airway pressure
 (APAP), 145
- Autoimmune disorders, drug interaction
 problem, 639–644
- Autoimmune thyroid disease, manifestation
 of, 275*f*
- Automated blood pressure devices, 41*f*
- Automated external defibrillators (AEDs),
 61, 78
- Automated peritoneal dialysis (APD), 199
- Autonomic nervous system, diabetic
 neuropathy and, 235
- Axonal damage, complication of, 539
- Azathioprine, 375
- Azotemia, 195
- B**
- Bacteremia
 bleeding and, 29–30
 frequency of, 27–28, 28*t*
 magnitude of, 28–29
 source, 27–28
- Bacterial endocarditis (BE), 19
 risk of, due to dental procedures, 29–30
- Bactericidal activity, 195
- Balloon angioplasty, 60
 catheter, 60*f*
- Barbiturates, drug interactions of, 639–644
- Bare metal stents, 60
- Basal cell carcinomas
 of dorsum of hands and ala of nose, 10*f*
 features of, 499*b*
- Basal insulin, 239
- Basal serum TSH concentration,
 measurement of, 272
- Basic cardiac life support (BCLS),
 provision, 597
- Basophils, 402
- Behavioral disorders, 6
 classification of, 545*b*
- Bell palsy, unilateral facial paralysis in, 10*f*
- Benign migratory glossitis, 557*f*
- Benzo[a]pyrene, 135
- Benzodiazepines, 549, 553, 588
 adverse effects of, 553
 drug interactions of, 558, 639–644
 users, proportion of, 588
 withdrawal symptoms, 588
- Bernard-Soulier syndrome, 437, 457–458,
 465
 clinical presentation of, 465
 laboratory and diagnostic findings of,
 465
 medical management of, 465
- Beta-blockers
 for angina, 59*t*, 60
 for arrhythmias, 76*t*
- Beta-lactams, drug interactions of, 639–644
- Biguanide, 243
- Bimanual palpation, of anterior neck, 11*f*
- Binding plasma proteins, 272

- Binge drinking, 583
 Binge eating disorder (BED), 551
 episodes of, 552
 Biofilm, 618–619
 Biologic agents, for rheumatic arthritis, 349–351, 351*t*
 Bioresorbable stents, 60
 Bipolar depression drugs, 572
 Bipolar disorder, 562–564
 dental management of, consideration in, 576*b*
 diagnosis of, 564
 drug therapy for, 565–566
 initial treatment guidelines for, 567*t*
 medical considerations for, 575–576
 NOS, 562–564
 types of, DSM-IV lists of, 562–564
 Bipolar I disorder, 562–564
 mood cycles of, 564*f*
 Bipolar II disorder, 562–564
 mood cycles of, 564*f*
 recurrences of, 564
 Bisphosphonate-associated osteonecrosis (BON), 302
 extraoral views of, 303*f*
 intraoral views of, 303*f*
 Bisphosphonates, 302
 dental treatment recommendations for, 305*b*
 sites of action of, 301*f*
 Bivalirudin, 442
 Bladder dysfunction, 235
 Bleeder
 clinical recognition of, 445*b*
 screening laboratory tests for detection of, 447*b*
 Bleeding, 509
 bacteremia and, 29–30
 clinical, timing of, 434
 hypertension and, 47
 ischemic heart disease and, 65
 medications causing, 446
 normal control of, 430*b*
 spontaneous, 446
 tendency of, longer than normal, 5
 white blood cell disorders and, 423
 Bleeding control
 hemostasis phases for, 430
 topical hemostatic agents used for, 474*t*
 Bleeding disorder
 relatives, 471
 serious, management of, 472–475
 Bleeding problems
 absence of clinical or historical clues to cause, 447
 illness, presence (association), 446
 in relatives, 445
 screening laboratory test for, selection of, 448*b*
 Blood
 changes, in pregnancy, 289
 clot, colored scanning electron micrograph, 432*f*
 coagulation of, 431, 432*f*
 components of, 433*t*
 nonprotein nitrogen compounds in, buildup of, 195
 turbulence, 4
 Blood coagulation components, 459*t*
 Blood glucose levels, 250
 Blood pressure, 13–14
 in adults, classification of, 14*t*
 classification of, 38, 39*t*–40*t*
 basis, 42
 dental management and follow-up recommendations based on, 47*t*
 Blood pressure (*Continued*)
 diagnosis of, basis, 42
 increase, 53–54
 lowering, benefit of, 519
 monitoring of, 263, 520
 for heart failure, 97
 normotensive adult, sound pattern, 13*f*
 physiologic factors for, 40
 reduction, 237
 Blood pressure cuff
 placement, 13*f*
 standard, 41*f*
 “Blood thinner”, 5
 Blood transfusion, 5
 Bloodborne pathogens, preventing transmission of, 613–614
 Bloodstream, HIV access to, 315
 “Blue bloaters”, 102
 B lymphocytes, 402
 B-natriuretic peptide, testing for levels of, 58
 “Bon-bon sign”, 574
 Bone disorders, 195–196
 Bone fractures, 299
 Bone marrow transplantation (BMT), 407
 Bone mineral density (BMD), 298–299
 Bone remodeling, 299*f*
 Bone resorption, uncoupling of, 299
 Bouchard nodes, in osteoarthritis, 356*f*
 Bradycardia, 13
 Bradykinesia, 523
 Brain reward circuits, 584*f*
 Branchial cleft cyst, development of, 268*f*
 Breast cancer, 488*t*, 493, 493*f*, 494*b*
 mammography for, 493, 493*f*
 screening for, 486–487
 Breastfeeding
 Food and Drug Administration labeling for drugs use in, 296*f*
 medication considerations during, 295*t*–296*t*
 Brittle diabetes, 251
 Bronchial asthma, 602
 Bronchodilators, inhaled, for COPD, 104–105
 Brown hairy tongue, 136*f*
 B symptoms, 415
 Buccal mucosa
 aphthous ulceration of, 556*f*
 lichen planus on, 557*f*
 squamous cell carcinoma of
 after hematopoietic cell transplantation, 384*f*
 ulceration, in systemic lupus erythematosus, 359*f*
 Bulimia nervosa, 550–551
 clinical findings of, 550*t*
 diet for, 557–558
 DSM-IV diagnostic criteria for, 552*b*
 epidemiology of, 550*t*
 serum amylase in, elevated, 552
 Bundle of His, 70
 Bupropion SR (Zyban), 135*t*
 Burkitt lymphoma, 417–418, 418*f*
 clinical presentation of, 417–418
 complications of, 417
 definition of, 417
 epidemiology of, 417
 etiology of, 417
 facial swelling in, 417*f*
 laboratory and diagnostic findings of, 418
 medical management of, 418
 oral complications and manifestations of, 418
 pathophysiology of, 417
 signs and symptoms of, 417
 Burning mouth syndrome, 633–634
 Buspirone, 553
 Bypass grafts, types of, 61*f*
 C
 CAGE questionnaire, 591
 Calcific aortic stenosis, 20*f*
 Calcification, of left carotid artery, 67*f*
 Calcified atherosclerotic plaques, 521–522
 Calcitonin, 270
 Calcium channel blockers (CCBs), 42
 for angina, 59*t*, 60
 gingival hyperplasia and, 50*f*
 Cancer, 8
 aggregation of, 481
 breast, 493
 cervical, 487–490
 clinical presentation of, 486–492
 colorectal, 495–496
 complications of, 480–486
 cytogenetic changes in, 486*f*
 death rate in, 480, 483*f*
 dental management of, 488*t*, 501–513, 502*t*
 considerations in, 506*b*, 509–510
 pretreatment evaluation and considerations, 502–504, 502*t*
 treatment planning modification, 502
 epidemiology of, 480–486, 481*f*, 482*t*
 features, 499*b*
 laboratory and diagnostic findings of, 492
 lung, 496–497
 malignancy, microscopic criteria for, 492*b*
 malignant cells, changes in, 485–486
 medical management of, 492–501, 492*t*
 Mendelian inheritance, 481
 Multinational Association of Supportive Care in Cancer/International Society of Oral Oncology (MASCC/ISOO), 503
 oral, 482*t*, 483*f*, 499–501, 499*b*, 500*f*
 oral care of patients with, 480–514
 pathophysiology of, 480–486
 patient
 dental preparation in, 504
 invasive oral procedures, outpatient setting recommendations, 506*b*
 post-cancer treatment management, 510–513
 pretreatment oral evaluation, 503, 503*b*–506*b*
 prostate, 490
 radiation therapy and chemotherapy management of, complication of, 504–509, 504*b*, 506*b*
 screening for, 486–490, 487*t*–489*t*
 skin, 498–499
 staging of, 490–492, 490*b*
 test for, 487
 therapy, oral care during, 504, 504*b*, 506*b*
 Cancer-related checkups, 490–492
Candida albicans, 627
 Candidiasis (fungal overgrowth), 181, 382, 382*f*
 clinical description of, 627
 etiology of, 627
 management of, 507–508, 508*b*
 as manifestation of HIV infection, 323–328
 treatment rationale for, 628
 Capreomycin (Capastat), 123*t*
 Carbamazepine, as mood-stabilizing drugs, 572

- Carbidopa-levodopa (Sinemet), 523–524
- Carcinogenesis, 481, 483f
- Cardiac arrest, 599
- Cardiac arrhythmias, 70–85
 - associated with various systemic diseases, 72t
 - cardiac risk stratification for noncardiac surgical procedures, 80b
 - classification of, 72b
 - clinical presentation of, 74
 - complications of, 71–74
 - dental management for, 78–83
 - devices in, 82
 - drug considerations in, 82
 - risk assessment, 79–80
 - dental management of
 - considerations for, 81b
 - drug interaction problem, 639–644
 - drugs and foods inducing, 72t
 - epidemiology of, 70
 - etiology of, 70–71
 - laboratory and diagnostic findings of, 74
 - medical considerations for, 78–80
 - medical management for, 74–78
 - oral manifestations of, 83
 - pathophysiology of, 71–74
 - patient identification for, 79b
 - perioperative risk and dental treatment for, 80b
 - signs and symptoms of, 74, 75b
- Cardiac contractions, control of, 70
- Cardiac cycle, electrocardiographic (ECG) tracing of, 71f
- Cardiac function, cellular automaticity, 70
- Cardiac risk stratification, for noncardiac surgical procedures, 47b
- Cardiac surgery, 32
- Cardiac valvular abnormalities, in systemic lupus erythematosus, 359
- Cardial risk stratification, for noncardiac surgical procedures, 64b
- Cardiopulmonary insufficiency, 10f
- Cardiopulmonary resuscitation (CPR) guidelines, 597
- Cardiovascular disease, 2–5
 - angina pectoris, 4
 - angioplasty, 5
 - arrhythmias, 4–5
 - artificial heart valve, 4
 - congenital heart disease, 4
 - coronary artery bypass graft, 5
 - heart attack, 3–4
 - heart failure, 2–3
 - heart murmur, 4
 - high blood pressure, 4
 - mitral valve prolapse, 4
 - rheumatic fever, 4
 - stent, 5
- Cardiovascular syphilis, 216
- Cardiovascular system, chronic kidney disease and, 195
- Cardioversion, 78
- Cardioversion/defibrillation paddles, 78f
- Caries, significance, 252
- Carotid artery, left, calcification of, 67f
- Carotid atheroma, 513, 522f
- Carotid pulse, palpation of, 12f
- Catatonic schizophrenic disorder, 569
- Cathepsin K inhibitor, sites of action of, 301f
- CD4+ lymphocyte counts, drop of, in chemoprophylaxis regimens, 320
- Cell
 - necrosis, 504–506
 - regulatory control, loss of, 483
- Cellular immune system, 333–334
- Cellulitis, from mandibular tooth abscess, 251f
- Centers for Disease Control and Prevention (CDC)
 - Guidelines for Infection Control in Dental Health-Care Settings*, 606, 610, 612
 - Guidelines to Prevent TB Transmission in Healthcare Settings*, 607
 - Interim Guidance on Infection Control Measures for H1N1 Influenza in Healthcare Settings, Including Protection of Healthcare Personnel*, 608
- Central nervous system
 - cancer predisposition syndromes, 484t–485t
 - depression, management of, 589
 - opiates, direct effects, 586
- Central nervous system (CNS) depressants, 283
- Cephalosporins, 337
 - as penicillin alternatives, 337
 - use of, penicillin hypersensitivity and, 338b
- Cerebral hypoxia, 598
- Cerebral infarction, in chronic hypertension, 517f
- cerebrospinal fluid shunts, 540–541
- Cerebrovascular accident. *see* Stroke
- Cervical cancer, 482t, 493–495, 495f
 - pap smear for, 494–495
 - screening for, 487–490
- Cervical lymph nodes, tuberculosis of, 124f
- Cervical lymphadenopathy, caused by tumor infiltrate, 414f
- Cervical region, external radiation of, 280–281
- CHA₂DS₂-VASc score, 75, 77t
- Chapped lips, 634
- Chédiak-Higashi syndrome, 464–465
- Cheilitis, 628–637
- Cheilosis, 628–637
- Chemical cautery, 627
- Chemosensory changes, 509
- Chemotherapy, 8
 - complication of, management of, 504–509, 504b, 506b
 - bleeding, 509
 - carotid atheroma, 513
 - fungal infection, 511
 - mucositis, 506–507, 507f
 - muscle trismus, 511–512
 - neural and chemosensory changes, 509
 - osteoradionecrosis, 512–513, 512b, 512f
 - prosthodontics, 512
 - secondary infections, 507–509
 - tooth sensitivity, 511
- Chest
 - malignant melanoma in, 498f
 - radiographs, for COPD, 103–104, 104f
- Chest pain, 603–604
 - in coronary atherosclerotic heart disease, 56
- Cheyne-Stokes respiration, 90–91
- Children, blood pressure
 - 95th percentile of, 40t
 - classification of, 39t
- Chloromas, 404–405
- Chondroitin sulfate, deposition of, 274
- Christmas disease. *see* Hemophilia B
- Chronic active hepatitis, 163
- Chronic ambulatory peritoneal dialysis (CAPD), 199
 - catheter site for, 200f
- Chronic bronchitis, 6, 101, 102f
- Chronic glomerulonephritis, atrophic kidneys from, 195f
- Chronic heart failure, with depressed ejection fraction, treatment algorithm for, 93f
- Chronic hepatitis, 154
- Chronic hypertension, cerebral infarction in, 517f
- Chronic infection, 163
- Chronic kidney disease
 - clinical presentation of, 196–198
 - comorbid conditions of, 199t
 - classification of, 194t
 - complications of, 194–196
 - conservative care for, 198, 201–206
 - definition of, 193
 - dental management of, 201–207 and dialysis, 193–209
 - drug adjustments in, 204t–205t
 - epidemiology of, 193–194
 - etiology of, 194
 - laboratory and diagnostic findings of, 198
 - medical considerations of, 201–203
 - medical management of, 198–201
 - oral complications and manifestations of, 203–205, 203b, 207
 - pathophysiology of, 194–196
 - prevalence of, 193
 - progression, renoprotective strategies for, 199t
 - signs and symptoms of, 196–198
 - stages of, 193
 - classification of, 194t
 - treatment planning modifications for, 205–206
- Chronic leukemias
 - acute leukemia, comparison, 413t
 - clinical factors in, 410t
- Chronic liver disease
 - ecchymoses on mucosa of hard and soft palate, 435f
 - jaundice with, 434f
 - spider angioma with, 435f
- Chronic lymphocytic leukemia, 411–412, 412f
 - clinical presentation of, 412
 - complications of, 411–412
 - definition of, 411
 - epidemiology of, 411–412
 - etiology of, 411
 - laboratory and diagnostic findings of, 412
 - medical management of, 412
 - oral manifestations of, 412
 - pathophysiology of, 411–412
 - signs and symptoms of, 412
- Chronic myelogenous leukemia, 409–411
 - clinical presentation of, 410
 - complications of, 410
 - definition of, 409
 - epidemiology of, 409–410
 - etiology of, 409–410
 - laboratory and diagnostic findings of, 410
 - medical management of, 411
 - oral manifestations of, 411
 - pathophysiology of, 410
 - signs and symptoms of, 410
- Chronic myeloid leukemia, 411f
- Chronic obstructive pulmonary disease (COPD), 101–108
 - chest radiograph for, 104f
 - clinical presentation of, 102
 - complications of, 101–102

- Chronic obstructive pulmonary disease (COPD) (*Continued*)
 dental management of, 105–108
 considerations for, 108*b*
 risk assessment, 105
 epidemiology of, 101
 etiology of, 101
 laboratory and diagnostic findings of, 102–104
 medical management of, 104–105
 oral complications and manifestations of, 108
 outpatient management of, drugs for, 106*t*–107*t*
 pathophysiology of, 101–102
 potential problems of, prevention of, 105
 predominant findings in, 102*b*
 signs and symptoms of, 102
 stages of, 104*b*
 treatment of, clinical algorithm for, 105*f*
- Chronic renal failure, clinical features of, 197*f*
- Chronic rheumatic heart disease, valve leaflet (diffuse fibrous thickening/distortion), 20*f*
- Chronic viral hepatitis, 151–152
- Cigarette smoking, coronary heart disease and, 54
- Cirrhosis, 6, 151, 169–170
 grading, scoring systems in, 173*t*
- Clinical bleeding
 symptoms, type and frequency, 465*f*
 timing of, 434
- Clinical hypothyroidism, characteristic of, 279*f*
- Clinical laboratory tests, 14–15
 values, 15*t*
- Clinical oncology syndrome, inherited cancer predisposition (syndromes), 484*t*–485*t*
- Clinically active sputum-positive tuberculosis, 121–122
- Clopidogrel, 60, 443
- Clostridium difficile*
 infection, 188*f*
 overgrowth of, 187
- Club drugs, 581
- Coagulation cascade, indicating intrinsic pathway, 437*f*
- Coagulation disorders, 439–440, 466–477
 history of, 471
 symptoms of, 471
- Coagulation pathways, with inhibitors, 433*f*
- Coagulation proteins, Food and Drug Administration-approved, 462*t*
- Coagulation system, 432*f*
 end product of, 432*f*
 organization of, 460*f*
- Cocaine, 586–587
 abuse of, 587
 medical considerations for, 589–590
 intoxication, 587
 overdose of, 587
- Codine, 338
- Cognitive disorders, classification of, 545*b*
- Coinfection, 160
- Colitis, 6
- Colon cancer, screening for, 487
- Colonoscopy, 495–496
- Colony-stimulating factors (CSFs), 402
- Colorectal cancer, 488*t*, 495–496, 495*f*
 chemotherapy for, 495–496
 colonoscopy for, 495–496
- Common pathway, disorders of, 437–438
- Compensated heart failure, 89
- Compensatory hypertrophy, 194–195
- Complementary and alternative medicine (CAM), 645
- Complementary and integrative medicine (CIM), 645
- Complementary medicine, definition of, 645
- Completed stroke, 518
- Computed tomography scans, for COPD, 103–104
- Condylomata acuminata, 324*f*
- Congenital bleeding disorders
 classification of, 458*b*
 clinical presentation of, 458
 complications of, 458
 dental management with, 471
 epidemiology of, 457–458
 etiology of, 457–458
 history and symptoms of, 471
 laboratory and diagnostic findings of, 458
 medical considerations for, 472
 medical management of, 458–460
 medical treatment of, 461*t*
 oral manifestations of, 477
 pathophysiology of, 458
 patient identification in, 471
 physical examination for, 472
 relatives, bleeding problems, 471
 screening laboratory tests for, 472
 signs and symptoms of, 458
 treatment planning modifications for, 477
 vascular defects in, 459–460
 clinical findings for, 459–460
 laboratory and diagnostic findings for, 460
- Congenital heart disease, 4
 infective endocarditis and, 19–20
- Congenital hereditary goiter, 268–270
- Congenital hypercoagulability, 470–471, 470*f*
- Congenital hypothyroidism, 279, 279*f*
- Congenital syphilis, 216
- Hutchinson's teeth, 217*f*
- Congestive heart failure, 57–58, 86–99
 drug interaction problem, 639–644
 occurrence of, 280
- Contact dermatitis, 615
- Contact stomatitis, 340–341
 management of, 341
- Continuous cyclic peritoneal dialysis (CCPD), 199
- Continuous positive airway pressure (CPAP), 145
- Continuous subcutaneous insulin infusion (CSII), 239–240
- Convalescence, 154
- Conversion disorder, 567–568
- Conversion reaction, 567
- Convulsions, 6, 600
- Cor pulmonale, 88–89
- Coronary artery
 occlusion, myocardial necrosis
 progression after, 57*f*
 stenosis/narrowing, cross-sectional area of, 56*f*
- Coronary artery bypass graft (CABG), 5, 61, 61*f*
- Coronary atherosclerosis, intraarterial complications of, 56
- Coronary atherosclerotic heart disease, 53
- Corticosteroids, 185
 inhaled
 for asthma, 112–113
 for COPD, 104–105
 for rheumatoid arthritis, 349, 351*t*
- Cortisol
 as adrenal cortex hormone, 258
 effects of, 256*f*
 physiologic actions of, 255–256
 secretion of, 256, 256*f*
- Co-testing, 487
- Cough etiquette, measures of, 608
- Coumadin, 428
- Coumarin, 442–443
 bleeding caused by, 430
 therapy, 449–451
- Counseling, for smoking and tobacco use
 cessation, 132, 132*b*
- “Crack” cocaine, 586–587
- Cracked lips, 634
- Creatine kinase isoenzyme (CK-MB), 58
- Crepitus, 356
- Cricothyroid membrane puncture, 601–602
- Cricothyrotomy, 602
- Crohn disease, 184
 intestinal mucosa, ulceration of, 184*f*
 oral manifestations of, 187
 signs and symptoms of, 184–185
 treatment, antibiotics for, 185
- Cushing disease, 258
 clinical manifestation of (“moon-shaped face”), 260*f*
- Cushing syndrome, 258–259
- Cyanocobalamin injections, 395
- Cyclic neutropenia, 403
- Cyclooxygenase (COX), 431
- Cyclooxygenase-2 (COX-2), upregulation of, 177
- Cycloserine, 123*t*
- Cyclosporine-associated gingival overgrowth, 380
 in renal transplant recipient, 380*f*
- Cyclothymic bipolar disorder, 562–564
 manifestation of, 564
- Cyklokapron, 475
- Cytomegalovirus (CMV), 218
 infection, 176
 medications for, 321
- D
- D₂ dopamine receptor (D₂DR), low density of, 583–584
- Dabigatran (Pradaxa), 442
 for cardiac arrhythmias, 80–82
- Daytime sleepiness, excessive, complaints of, 142
- Decompensated heart failure, 89
- Deep vein thrombosis, swollen left leg, 443*f*
- Defibrillation, 78
- Degenerative joint disease. *see*
 Osteoarthritis (OA)
- Dehydroepiandrosterone (DHEA), 257
- Delayed hypersensitivity, 333
- Delta hepatitis, 161
- Delta-9-tetrahydrocannabinol (THC), 585
- Delusional (paranoid) disorder,
 classification of, 545*b*
- Dementia, 527–532
 clinical presentation of, 527–528
 complication of, 527
 dental management of, 529–532
 considerations in, 529*b*
 epidemiology of, 527
 general description of, 527
 laboratory and diagnostic findings of, 528
 medical management of, 528–529
 oral complications and manifestations of, 531–532
 pathophysiology of, 527
 prevalence of, 527
 signs and symptoms of, 527–528, 528*t*

- Dendritic cells, 402
- Denosumab, sites of action of, 301*f*
- Dental appointment, prolonged, 32
- Dental extraction, hemorrhage, 477*f*
- Dental health care
- 2009 H1N1 influenza transmission
 - prevention in, 607
 - infection control guidelines in, 606–622
 - personnel, 608
 - specific recommendations for, 608
- Dental management
- patient evaluation, summary, 3*b*
 - risk assessment, summary, 3*b*
- Dental materials and products, allergic reactions to, 338–339
- Dental office emergencies, 597–605
- algorithms for, 598
 - general considerations for, 597–598
 - kit for, 605
 - management of, 597
 - pediatric drug doses, 605
 - treatment of, 598–605
 - types of, 598–605
- Dental operative unit, backflow prevention and, 606
- Dental radiographs, controversial areas in, 291
- Dental unit water lines, infection control, 618–619
- Denture sore mouth, 633
- Deoxyribonucleic acid (DNA), reverse transcription of, 314
- Dependence, 581
- diagnostic criteria for, 585*t*
 - neurobiology of, complexity, 583–584
 - substance, 584–585
- Depression
- dental management of, considerations in, 576*b*
 - drug interaction problem, 639–644
 - lack of oral hygiene and, 575
 - medical consideration of, 575
 - signs of, 575
- Depression not otherwise specified (NOS), 562
- Depressive disorders, 562
- diagnostic criteria for, 563*b*
 - type of, DSM-IV lists of, 562
- Dermis, hyaluronic acid and chondroitin sulfate deposition in, 274
- Desirudin, 442
- Diabetes, 7
- acute oral infections, dental management of, 250*b*
 - clinical detection of, 248*b*
 - complications, severity of, 235
 - dental management of
 - considerations in, 249*b*
 - decision-making diagram for, 250*f*
 - diabetic gangrene of feet, 235*f*
 - early clinical manifestations of, 236*b*
 - glucose screening for, 58
 - glycemic control of, 235
 - increased risk for, 237*t*
 - inflammatory responses to, 251
 - noninsulin antidiabetic drugs for, 241*t*–242*t*
 - oral candidiasis with, 252*f*
 - oral lesions of, 252
 - palate lesion in, 252*f*
 - periodontal or oral surgery procedures for, 250
 - skin rashes, association, 235
 - vital signs, as guide for, 248
- Diabetes Control and Complications Trial (DCCT), 238*f*
- Diabetes mellitus, 230–254
- classification of, 231*b*
 - clinical presentation of, 235–237
 - complications of, 232–235, 234*b*
 - comprehensive management plan for, 243*b*
 - coronary atherosclerotic heart disease, incidence, 54
 - definition of, 230
 - dental management of, 247–252
 - diagnostic criteria for, 236*t*
 - drug interaction problem, 639–644
 - epidemiology of, 230–235
 - epinephrine for, 250
 - etiology of, 231–232
 - expected years of additional life for, 234*t*
 - gene defects and, 232
 - importance of, 230
 - incidence of, 230
 - laboratory and diagnostic findings of, 235–237
 - medical management of, 237–247, 238*b*
 - oral complications and manifestations of, 251–252
 - pathogenic processes of, 231–232
 - pathophysiology of, 232–235
 - prevalence of, 230–231
- Diabetic neuropathy
- autonomic nervous system and, 235
 - cross-section of kidney, 234*f*
- Dialysis
- and chronic kidney disease, 193–209
 - patients receiving, 206–207
- Diastolic pressure, 40
- Diatheses, bleeding, 197–198
- Diazepam, 553
- Digitalis glycosides, 93
- Digitalis toxicity, clinical manifestations of, 95*b*
- Digits, clubbing of
- cardiopulmonary insufficiency and, 10*f*
 - in infective endocarditis, 24, 25*f*
- Digoxin toxicity, 82
- Dilated cardiomyopathy (DCM), 87
- Dipeptidyl peptidase IV (DPP-IV), 244
- Diphenhydramine, usage, 336
- Dipyridamole, 60
- Direct factor Xa inhibitors, 442, 451
- Direct thrombin inhibitors, 442, 451
- Disease-modifying antirheumatic drugs (DMARDs), for rheumatic arthritis, 349, 351*t*
- Disinfection, of patient care items, 615–617
- Disorganized schizophrenic disorder, 569
- Disseminated intravascular coagulation, 439–440
- clinical presentation of, 439
 - laboratory and diagnostic findings of, 439–440
 - medical management of, 440
 - staphylococcal septicemia and, 440*f*
- Dissociative drugs, 581
- Distant metastases, 501
- Distended jugular vein, with heart failure, 90*f*
- Disulfiram, 589
- Divalproex, as mood-stabilizing drugs, 572–573
- Donor-recipient matching, for organ transplantation, 373
- Dopamine, increasing, 523
- Doxycycline, drug interactions of, 639–644
- Drug abuse, 581
- addiction/dependence, neurobiology (complexity), 583–584
 - clinical presentation of, 584–589
- Drug abuse (*Continued*)
- definitions of, 581
 - dental management of, 589–593
 - diagnostic criteria for, 585*t*
 - epidemiology of, 581–584
 - etiology of, 583–584
 - medical considerations for, 589–593
 - medical management of, 584–589
 - oral complications and manifestations of, 593
 - relapse, minimizing risk, 592–593
 - treatment planning considerations for, 593
- Drug-eluting stents, 60
- Drug-induced angioedema, 333
- Drugs
- of abuse, acute actions of, convergence, 584*f*
 - addiction, 8
 - considerations, 8–9
 - interactions, 639–644
- Duke criteria, 24
- Dwarfism, neonatal hypothyroidism and, 279
- Dyspepsia, drug interaction problem, 639–644
- Dysplastic tissue, 483, 483*f*
- Dyspnea, 275
- Dysthymic disorder, 562
- E
- Ears
- examination, 10–11
 - melanoma of, 11*f*
- Eating disorders, 550–558
- anorexia nervosa as, 550–551, 556*f*
 - binge eating disorder (BED) as, 551
 - bulimia nervosa as, 550–551
 - clinical findings of, 550*t*
 - clinical presentation of, 551–553
 - cultural issues of, 551
 - definition of, 550–551
 - diagnosis of, 551
 - epidemiology of, 550*t*, 551
 - etiology of, 551
 - genetic factors of, 551
 - incidence of, 551
 - laboratory findings of, 552–553
 - medical management for, 553, 556–558
 - oral complications and manifestations of, 558
 - patients' attitudes toward dentists, 554
 - prevalence of, 551
 - psychiatric factors of, 551
 - signs and symptoms of, 551–552
 - treatment planning considerations of, 558
- EBV nuclear antigen (EBNA), antibody tests to, 222
- Ecchymoses, with liver disease, 434
- Ecchymosis, 9*f*
- Echocardiography, for infective endocarditis, 25
- E-cigarettes, 134
- Eclampsia, 289
- Ectopic pacemaker, 70
- Edoxaban (Savaysa), for cardiac arrhythmias, 80–82
- Ehlers-Danlos disease, 458
- Ejection fraction, 88
- depression of, 89*f*
- Electric shock, transthoracic delivery of, 78
- Electrical conduction system, of heart, 71*f*
- Electrocardiogram (ECG), waves/intervals, 62*f*
- Electromagnetic interference, 77, 78*b*, 82

- Electronic nicotine delivery, 134
 Electrophoresis, 394–395
 Emergencies
 care, principles of, 598
 kit for, 605
 Emotional lability, of thyrotoxicosis (hyperthyroidism), 275
 Emphysema, 6, 101
 pathogenesis of, 103f
 Enamel
 erosion of, 181
 lingual erosion of, 557f
 Endocarditis
 adverse outcome risk, cardiac conditions, 30b
 prophylaxis, 34b
 Endocrine disease, 7
 diabetes, 7
 thyroid disease, 7
 Endometrial (uterine) cancer, 490
 Endothelial cells, 430
 Endothelial injury, 54
 End-stage renal disease (ESRD), 193
 bleeding diatheses and, 197–198
 cardiovascular manifestations of, 198
 causes of, 194
 corticosteroids for, 203
 dental management considerations with, 202b
 oral candidiasis with, 197f
 palatal petechiae in, 205f
 treatment for, 203
 Entry, as HIV-1 infection stage, 314
 Environmental infection control, 617–618
 Enzyme-linked immunosorbent assay (ELISA), 317–318
 Eosinophils, 402
 Epilepsy, 6, 532–538
 clinical manifestations of, 533–534
 clinical presentation of, 533–534
 complications of, 533
 dental management of, 535–538
 considerations in, 536b
 diagnosis of, 534
 epidemiology of, 532–533
 general description of, 532
 laboratory and diagnostic findings of, 534
 medical management of, 534–535
 oral complications and manifestations of, 537–538
 pathophysiology of, 533
 Epileptic syndromes, classification of, 532b
 Epinephrine (Primatene Mist), 115
 cardiovascular effects of, 49, 49f
 drug interactions of, 639–644
 form of, 578
 Episolon Aminocaproic Acid (EACA), 475
 Epstein-Barr virus (EBV), 218
 Epworth Sleepiness Scale, 142, 143f
 Equivalent background exposure, effective dose from, 292t
 Erythema migrans, 629
 lesion, of Lyme disease, 365f
 Erythema multiforme, 340
 development, oral drug administration, 340f
 Erythematous candidiasis, of left buccal mucosa, 382f
 Erythematous lesions, in acquired immunodeficiency syndrome (AIDS), 323f
 Erythematous palatal lesion, in HIV, 323f
 Erythremia migrans, 557f
 Erythropoiesis, 390
 Esophageal varices, 169–170
 from alcoholic patient, 170f
 Estrogen, secretion of, increased, 297–298
 Ethambutol (Myambutol), 123t
 Ethanol abuse, 170–171
 Ethionamide (Trecator-SC), 123t
 Exercise intolerance, in heart failure, 90–91
 Exercise-induced asthma, 109
 Exophthalmos, 277
 Expandable metallic stent, 60f
 Extensively drug-resistant (XDR)-TB, 120
 Extranodal lymphomas, 415
 Extrapyramidal reactions, 604–605
 Extrinsic asthma (allergic asthma), 109
 processes involve in, 110f
 Extrinsic pathway, 431–432
 disorders of, 437
 Eye movement desensitization and reprocessing (EMDR), 550
 Eyelids
 changes in, in Graves disease, 273f
 lag, 274
 xanthomas of, 11f
 Eyes, physical examination, 10
 F
 Face
 erythematous lesions in, 323f
 physical examination, 10
 Facial impassiveness, 523
 Facial palsy, 50
 Factitious disorder, 568
 Factitious disorders, classification of, 545b
 Factor V deficiency, 469
 Factor V Leiden mutation, 471
 Factor VII deficiency, 469
 Factor VIII activity, assay of, 466
 Factor VIII coagulant activity, 465
 Factor X deficiency, 469
 Fast sodium channel blockers, for arrhythmias, 76t
 Fatty liver, 169
 Feet, diabetic gangrene of, 235f
 Fenethylamine, 587
 Fetal development, general pattern of, 289
 Fetal growth, consideration of, 289–290
 Fetus, teratogenicity and, 293
 Fever, in infective endocarditis, 24
 Fibrin, 431
 degradation products of, 438
 Fibrin degradation products (FDPs), 433
 Fibrin-lysing system, 432–433, 433b
 Fibrinogen, 431
 Fibrinogenolysis, 440
 Fibrinolysis, 440
 altered, 297–298
 Fibrinolytic disorders, 440–443
 Fibrinolytic pathways, with inhibitors, 433f
 Fibrinolytic system, 433b
 Fibroblast growth factor 23 (FGF-23), levels of, 196
 Fibromyalgia syndrome (FMS), 345, 366–367
 clinical presentation of, 366
 definition of, 366
 dental management of, 366–367
 epidemiology of, 366
 medical management of, 366
 oral complications and manifestations of, 367
 symptoms of, 367b
 tender points, illustration, 367f
 Fingers, clubbing of, 184–185
 in congestive heart failure, 91f
 First-generation (atypical) antipsychotic drugs, 573
 Fluoroquinolones, drug interactions of, 639–644
 “Flycatcher’s tongue”, 574
 Folate deficiency anemia, 390
 medical management of, 395
 pathophysiology and complications of, 392
 Follicular carcinomas, treatment of, 282
 Follicular lymphoma, 416
 Forced expiratory volume, measurement of, by spirometry, 104f
 Forced expiratory volume in 1 second (FEV₁), 102–103
 Forced vital capacity (FVC), 102–103
 Foreskin, recurrent herpes simplex virus infection of, 219f
 Formal thought disorder, 569
 FRAMES acronym, 591
 Freebasing, cocaine, 586–587
 Fulminant hepatitis, 154, 162
 Functional capacity, 9
 Functional residual capacity (FRC), 289
 Functioning nephrons, deterioration and destruction of, 194–195
 Fungal infection, 511
 Fungal overgrowth (candidiasis), 181
 G
 Gastritis, 6
 Gastroesophageal acid reflux, asthma and, 115–116
 Gastroesophageal reflux, drug interaction problem, 639–644
 Gastrointestinal diseases, 6, 176–191
 cirrhosis, 6
 colitis, 6
 gastritis, 6
 hepatitis, 6
 intestinal ulcers, 6
 jaundice, 6
 liver disease, 6
 stomach ulcers, 6
 General appearance, 9–11
 General tonic-clonic seizures/convulsions (grand mal seizures), 536
 anticonvulsants for management of, 534t
 clinical manifestations of, 533–534
 lower lip laceration and, 537f
 teeth fracture and, 537f
 Generalized anxiety disorder, 545, 547–548, 547t
 diagnostic criteria of, 547t
 signs and symptoms of, 547t
 Generalized gingivitis, 298f
 Genetic clotting factor deficiencies, 469–477
 Genetics, atherosclerosis and, 53
 Genital herpes, 218–220
 clinical presentation of, 218–219
 dental considerations for, 220
 epidemiology of, 218
 etiopathogenesis of, 218
 laboratory and diagnostic findings of, 219
 medical management of, 219–220
 oral manifestations of, 220
 primary infection, 218–219, 221f
 recurrent infection, 219
 treatment, Centers for Disease Control and Prevention for, 220b
 Genital warts, 222–226
 clinical presentation of, 223
 dental considerations for, 225–226
 epidemiology of, 222–223
 etiopathogenesis of, 223
 laboratory and diagnostic findings of, 223
 medical management of, 223–225
 oral manifestations of, 225–226

- Genitourinary cancer predisposition syndromes, 484t–485t
- Genitourinary tract disease, 7–8
kidney failure, 7
sexually transmitted disease, 7–8
- Genodermatoses, with cancer predisposition, 484t–485t
- Geographic tongue, 629
- Gestational diabetes, 231
- Gestational diabetes mellitus (GDM)
development of, 289
occurrence of, 232
- Ghon complex, 117
- Giant cell arteritis (GCA), 345, 364–365
definition of, 364
dental management of, 364–365
histology of, 364f
medical management of, 364
signs and symptoms of, 365b
- Gingiva
condylomata acuminata in, 324f
Kaposi sarcoma of, 324f
- Gingival enlargement, 634–635
leukemic, 423f
- Gingival hyperplasia, 50f
- Gingival overgrowth, cyclosporine-associated, 380
in renal transplant recipient, 380f
- Gingival recession, 136f
- Gingival retraction cords, 283
- Glanzmann disease, 437
- Glanzmann thrombasthenia, 457–458, 466
- Glinides (repaglinide [Prandin] and nateglinide [Starlix]), 243–244
- Glossitis, benign migratory, 629
- Glossodynia, 362–363
- Glove, usage of, 614–615
- Glucocorticoids
increase need of, 258t
potency of, 257t
production, drugs interfering, 258t
replacement of, 260–261
- Glucophage, 243
- Glucose
cortisol and insulin effects on, 256f
excretion, 232
utilization, lack of, 232–233
- Glucose-6-phosphate dehydrogenase (G6PD) deficiency, 5, 390
clinical features of, 392–393
drug sensitivity, increase, 397
peripheral blood films, 395f
- Glucose-lowering agents, 242–246
- α -Glucosidase inhibitors, 245
- Glycemia
disorders of, 231f
management, targets for, 237t
- Goiter, 268
midline neck enlargement from, 11f
- Goitrous hypothyroidism, Hashimoto disease causing, 278f
- Golimumab, 185
- Gonorrhea, 210–213
caused of, 210–211
clinical presentation of, 212
dental considerations for, 213
epidemiology of, 211
etiopathogenesis of, 211–212
incidence of, 211
laboratory and diagnostic findings of, 212–213, 216–217
Neisseria gonorrhoeae infection, 210–211
oral manifestations of, 213
- Gout, 345
drug interaction problem, 639–644
- Graft rejection, 333–334, 373–374
- Graft-versus-host disease (GVHD), 370, 383, 423
oral features of
with diffuse ulcerations of lips and tongue, 383f
with extensive lichenoid inflammation, 383f
salivary gland dental caries in, 383f
- Gram-negative diplococci, smear demonstrating, 213f
- Grand mal seizures (general tonic-clonic seizures/convulsions), 536
anticonvulsants for management of, 534t
clinical manifestations of, 533–534
lower lip laceration and, 537f
teeth fracture and, 537f
- Granulocyte chemotaxis, diminished, 195
- Granulocytes, 402
- Granulocytic sarcomas, 404–405, 409
- Graves disease, 268–270
as autoimmune disease, 273
epidemiology of, 271
etiology of, 271–272
exophthalmos of, 273f
eyelid changes in, 273f
infiltrative dermopathy in, 275f
laboratory and diagnostic findings of, 272, 272t
pathophysiology of, 272
prevalence of, 271
proptosis in, 273f
thyroid acropachy, manifestation of, 275
thyroid gland, diffuse enlargement of, 270f
- Graves ophthalmopathy, 273–274
- Gross renal anatomy, 195f
- Group D streptococci, 21
- Growth-promoting substances, 402
- Guidelines for Infection Control in Dental Health-Care Settings*, 606, 610
- Gummatous disease, 216
- H
- H1N1 influenza
control of, 608–609
transmission, prevention of, in dental health care settings, 607–609
- HACEK group, 21
- Haemophilus influenzae*, vaccination against, 395–396
- Hairy leukoplakia, 328
tongue lesion in, 324f
- Hallucinogens, 581
- Hancock porcine bioprosthetic valve, 23f
- Hands
dorsum, basal cell carcinomas of, 10f
hygiene, 614
pallor of, 396f
rheumatoid arthritis, 348f
- Hapten, 333
- Hard palate, mucosa, ecchymoses, 435f
- Hashimoto thyroiditis, 268–270
as cause of goitrous hypothyroidism, 278f
clinical presentation of, 277–278
goiter and, 277
laboratory findings of, 277–278
medical management of, 278
- Havrix, 155–156
- Head
examination, 14
lesions in, with HIV infection and AIDS, 325t
- Heart
electrical conduction system of, 71f
enlargement of, 280f
palpitations of, 57
- Heart attack, 3–4
- Heart block, 73–74
- Heart failure, 2–3, 86–99
ACE inhibitors, 93
AHA/ACC classification of, 89
causes of, 87b
chronic, with depressed ejection fraction, treatment algorithm for, 93f
clinical predictors, 64b
clinical presentation of, 90–91
complications of, 86–90
definition of, 86
dental management of, 95–97, 96b
digitalis glycosides for, 93
distended jugular vein with, 90f
ejection fraction depression and, 89f
epidemiology of, 86
infective endocarditis with, 22–23
jugular vein, distended, 90f
laboratory and diagnostic findings of, 91–92
medical management of, 90b, 92–95
New York Heart Association (NYHA) classification of, 89b, 91
oral manifestations and complications of, 97
pathophysiology of, 86–90
pitting edema with, 91f
signs of, 87b, 89
stage of, therapeutic decision making according to, 92f
symptoms of, 87b, 89
treatment of, drugs for, 94t
- Heart murmur, 4
- Heart transplantation, 371
- Heberden nodes, in osteoarthritis, 356f
- Height, 14
- Heinz bodies, screening tests for, 394
- Helicobacter pylori*
host response to, 176
infection, in peptic ulcer disease, antimicrobial regimens for treatment of, 180b
organisms, presence, 179f
peptic ulcer disease associated with, 178
- Hemarthrosis, with hemophilia, 467f
- Hematologic disorders, 5
hemophilia, 5
inherited bleeding disorder, 5
- Hematomas, massive, with hemophilia, 468f
- Hematopoietic cell transplantation, 372
organ-specific complications of, 375–376
- Hemodialysis, 200, 200f
- Hemolytic anemia, 390, 399f
- Hemophilia, 5
dental management of, 472–475, 473b
with inhibitors, 469
massive hematomas in, 468f
submandibular region, swelling (intraoral trauma), 467f
trauma in, subcutaneous ecchymoses, 459f
without inhibitors, 469
- Hemophilia A, 466–469
clinical presentation of, 466–467
dental management of, 472–475
Food and Drug Administration-approved clotting concentrates for, 461t–462t
hemarthrosis with, 467f
laboratory and diagnostic findings of, 467

- Hemophilia A (*Continued*)
 medical management of, 468–469
 replacement factors for, 468–469
- Hemophilia B (Christmas disease), 469
 epidemiology of, 457
 Food and Drug Administration-approved
 clotting concentrates for, 461*t*–462*t*
 gene therapy for, 469
- Hemorrhage, dental extraction, 477*f*
- Hemorrhagic diatheses, 195
- Hemorrhagic stroke, hypertension as risk
 factor for, 516
- Hemostasis, preoperative evaluation of,
 443–444
- Heparin, 441–442
 bleeding caused by, 430
 subcutaneous, usage, 441*f*
 synthetic, 442
 therapy, 451
- Hepatitis, 6, 151–155
 chronic, 154
 clinical presentation of, 153–154
 complication of, 153
 definition of, 151
 epidemiology of, 151–152
 etiology of, 152
 incubation period, 153
 laboratory and diagnostic findings, 154
 medical management of, 154–155
 pathophysiology of, 153
 viral, 151
- Hepatitis A, 155–156
 clinical presentation of, 155
 complications of, 155
 epidemiology of, 155
 laboratory and diagnostic findings, 155
 medical management of, 155–156
 pathophysiology of, 155
- Hepatitis B, 156–158
 antiviral therapy for, 157–158
 clinical presentation of, 157
 complications of, 156–157
 epidemiology of, 156, 156*f*
 frequently asked questions, 606
 laboratory and diagnostic findings, 157
 medical management of, 157–158
 pathophysiology of, 156–157
 risk, 165*b*
- Hepatitis B virus infection
 high risk for, 166–167
 increase, 200–201
- Hepatitis C, 158–159
 clinical presentation of, 158
 complications of, 158
 epidemiology of, 158
 laboratory and diagnostic finding of,
 158–159, 159*t*
 medical management of, 159
 pathophysiology of, 158
- Hepatitis C virus infection
 high risk for, 166–167
 increase of, 200–201
- Hepatitis D, 159–161
 clinical presentation of, 160
 complications of, 160
 epidemiology of, 159–160
 laboratory and diagnostic findings,
 160
 medical management of, 160–161
 pathophysiology of, 160
- Hepatitis E, 161
 complications of, 161
 epidemiology of, 161
 laboratory and diagnostic findings of,
 161
 pathophysiology of, 161
- Hepatitis non-A-E, 162–164
 clinical presentation of, 162–164
 complications of, 162–164
 dental management of, 166–168
 with active hepatitis, 166
 hepatitis carriers, 167
 with high risk for hepatitis B virus/
 hepatitis C infection, 166–167
 with history of hepatitis, 166
 signs and symptoms of hepatitis,
 167–168
 treatment considerations in specific
 groups, 166–168
 drug administration in, 168
 epidemiology of, 162
 exposure control of plan, 169
 laboratory and diagnostic findings of, 162
 laboratory findings, 164
 medical management of, 162
 pathophysiology of, 162–164
 postexposure protocols, for health
 workers, 160*t*, 168–169
 prevention of, 164–165
 through active immunization, 164–165
 through passive immunization, 165
 treatment of, 165–166
 planning modifications, 168
- Hepatitis virus, blood exposure,
 management of, 160*t*
- Herbal actions, claims (clinical trial
 support), 647*t*
 absence, 647*t*
- Herbal medicines
 adverse effects of, 646–648
 seriousness, 648*t*
 adverse reactions to, 646–648
 dental implications, 649–650
 efficacy of, 646
 absence/doubt, 646
 information about, 650
 medical problems in, 648
 standard tinctures in, 645
- Herbal products, drug interactions in,
 648–649
- Herbal remedies, 645–646
 toxicity of, 646
- Herbal supplements, 646
- Hereditary angioedema, 333, 339
- Hereditary breast cancer syndromes,
 484*t*–485*t*
- Hereditary gastrointestinal malignancies,
 484*t*–485*t*
- Hereditary hemorrhagic telangiectasia,
 458–459, 463*f*
 medical management of, 460
- Hereditary platelet function disorders
 (HPFDs), 464–466
- Hereditary thrombocytopenia (HT), 465
- Hermansky-Pudlak syndrome, 464–465
- Heroin, 583
- Herpes simplex
 with oral lesions, 624–628
 recurrent, 625
- Herpes simplex virus (HSV)
 HSV-1
 causative agent, 218
 infections, pathogenesis of, 218
 lesions, 219
 primary infections of, 218–219
 HSV-2
 infections, pathogenesis of, 218
 lesions, 219
 infection, 382–383
 recrudescence, in anterior and posterior
 tongue dorsum, 382*f*
 recurrent, 219*f*
- Herpes simplex virus (HSV) (*Continued*)
 medications for, 321
 type of, 218
- Herpetic paronychia, 220, 221*f*
- Herpetic whitlow, 221*f*
- Herpeticiform ulcers, 626
- High blood pressure, 4
 prevention and reduction of, lifestyle
 modifications, 42*b*
- High responders, 469
- Highly active antiretroviral therapy
 (HAART), 310, 318–320
- High-performance liquid chromatography,
 394–395
- High-risk HPV, 222
- Hip fractures, 299
- Hives, 6
- Hodgkin lymphoma, 414*f*
 Ann Arbor staging system for, 415*f*
 clinical presentation of, 413
 complications of, 413
 definition of, 413
 epidemiology of, 413
 etiology of, 413
 laboratory and diagnostic findings of,
 413
 medical management of, 414
 non-Hodgkin lymphoma, comparison,
 416*t*
 pathophysiology of, 413
 signs and symptoms of, 413
- Homeopathic techniques, effects of, 649*t*
- Hospitalizations, history of, 8
- Human anaphylactic reactions, causes of,
 331*b*
- Human herpesvirus type 6 (HHV-6), 218
- Human herpesvirus type 7 (HHV-7), 218
- Human immunodeficiency virus (HIV)
 bloodstream access, 315
 life cycle of, 314*f*
 structure of, 314*f*
- Human immunodeficiency virus (HIV)
 infection, 309–329
see also Acquired immunodeficiency
 syndrome (AIDS)
 antiretroviral drugs used for, 319*t*, 320*b*
 antiretroviral therapy (ART) for,
 318–320
 candidiasis, manifestation of, 323–328
 CD4+ count, decline, 318
 chemoprophylaxis for, 320
 clinical presentation of, 316–318
 complications of, 314–316
 definition of, 309
 dental management for, 320–328
 considerations in, 327*b*
 and disease progression, 316*t*
 enzyme-linked immunosorbent assay
 (ELISA) for, 317–318
 erythematous lesions in, 323*f*
 palatal, 323*f*
 etiology of, 310–316
 features of, 316*t*
 head, neck, and oral lesions associated
 with, 325*t*
 health care personnel, risk of
 transmission from, 322
 HIV-1 infection, stages of, 314
 HIV-associated morbidity, reduction, 318
 HIV-infected patients
 dental treatment of, 321
 linear gingival erythema in, 324*f*
 necrotizing ulcerative periodontitis in,
 324*f*
 immunologic function, restoration and
 preservation, 318

- Human immunodeficiency virus (HIV)
infection (*Continued*)
implications of, 309
incidence of, 309–310
increase, 200–201
invasive dental procedures, planning for, 321
laboratory and diagnostic findings for, 317–318
laboratory-confirmed evidence of, 309
medical management for, 318–320
men who have sex with men (MSM) and, 314–315
natural history of, 317f
occupational exposure to, 322
oral complications and manifestations of, 322–328
oral conditions associated with, 326t–327t
oral lesions, signs of, 322–323
pathophysiology for, 314–316
patient characteristics in, 311t–312t
periodontal disease and, 321–322
postexposure prophylaxis (PEP) for, 322
prevalence of, 309–310
RNA retrovirus in, 314
signs and symptoms of, 316–317
stages of, in CDC definition of, 316–317
steady-state viremia, development of, 315
surgical procedures, medical consultations for, 321
testing, 320
transmission, prevention of, 318
treatment planning considerations for, 321–322
vertical transmission of, 315
- Human papillomavirus (HPV) infections, 222–226, 224f
associated lesions and genotypes, 223b
clinical presentation of, 223
dental considerations for, 225–226
epidemiology of, 222–223
etiopathogenesis of, 223
incidence of, 222–223
laboratory and diagnostic findings of, 223
medical management of, 223–225
oral manifestations of, 225–226
prevalence of, 222–223
vaccine, 225
- Human papillomaviruses, 493–494
- Humoral immune system, 331–333
functions of, 333b
- Hürthle cell cancers, treatment of, 282
- Hutchinson's teeth, congenital syphilis, 217f
- Hyaluronic acid, deposition of, 274
- Hydrocephalus, 540–541
- Hygiene, hand, 614
- Hyperadrenalism, 258, 260
- Hypercholesterolemia, lipid screening, 58
- Hypercoagulable disorders, 428–456
- Hypergammaglobulinemia, in Sjögren syndrome (SS), 361
- Hyperglycemia, 230
effects of, 251
pathophysiology of, 233f
treatment, antidiabetic agents for, 244f
- Hyperlipidemia, drug interaction problem, 639–644
- Hyperplastic gingiva, with leukemia, 435f
- Hyperplastic gingival changes, 297–298
- Hypersensitivity, oral complications and manifestations of, 339–341
- Hypersensitivity reactions, categories of, 332f
- Hypertension, 38–52
bleeding and, 47
cardiovascular risk stratification, perioperative, 46b
causes of, 39b
clinical presentation of, 40–41
complications of, 39–40
dental management in, 44–50, 48b
chair position for, 48
drug considerations for, 48–49
risk assessment, 46
drug interactions, problem, 49–50, 639–644
epidemiology of, 38–39
etiology of, 39
laboratory and diagnostic findings of, 41
management of, drugs used in, 43t–44t
medical considerations for, 44–50
medical management of, 41–44
noncardiac surgical procedures, cardiac risk stratification, 47b
oral manifestations, 50
pathophysiology of, 39–40
pharmacologic management of, 42
prevalence of, 38
primary, 39–40
signs and symptoms of, 40–41, 41b
early, 41
late, 41
stress management for, 47–48
treatment of
drugs, availability, 42
JNC 8 recommendations, 42, 45f
vasoconstrictors for, 48–49
- Hypertensive atherosclerosis, 517
- Hypertensive emergency, 42–44
- Hypertensive urgency, 42–44
- Hyperthyroidism
lid retraction from, 11f
oral manifestations of, 285
toxic adenoma and, 270f
- Hypertrophic form, 507
- Hyperventilation, 601
- Hypoadrenalism, 258–260
- Hypochondriasis, 568
- Hypoglycemia, 599
- Hypomania, clinical features of, 565t
- Hypopnea, 143
- Hyposalivation
direct effects of, 507f, 510
sequelae, 508b, 510–511
in Sjögren syndrome, 360–361
- Hypothalamic-pituitary-adrenal (HPA) axis
cortisol secretion regulation and, 256, 256f
responsiveness of, 259
- Hypothalamic-pituitary-thyroid axis, stimulatory/inhibitory effects of, 271f
- Hypothyroidism, 278–280
clinical presentation of, 279
congestive heart failure, occurrence of, 280
epidemiology of, 279
identification of, 283
medical consideration of, 283–285
medical management of, 279–280
onset of, 279
oral manifestations of, 285
severe, 281f
signs and symptoms of, 279
- I
Icteric phase, 154, 163
- Icterus, 162
- Idiopathic thrombocytopenia, 428–429
- If Saliva Were Red*, 606–607
- Illicit drugs of abuse, 581
common, 582t–583t
- Immune complex-mediated hypersensitivity, 333
- Immune dysfunction, antiretroviral drugs for, 318
- Immune reconstruction inflammatory syndrome (IRIS), 320
- Immunoglobulin E, 331
- Immunoglobulins, functions of, 331b
- Immunologic changes, in pregnancy, 289
- Immunosuppressants, for recurrent aphthous stomatitis, 627
- Immunosuppression, drug interaction problem, 639–644
- Immunosuppressive medications
for organ transplantation, 373
side effects of, 375
in transplant medicine, 374t
- Immunosuppressive therapy, 376
- Impaired fasting glucose, diagnostic criterion for, 236
- Impaired glucose tolerance (IGT), 236
- Implantable cardioverter-defibrillators (ICDs), 76–78, 82, 95
electromagnetic interference sources, 78b
- Implanted permanent pacemakers, for cardiac arrhythmias, 75–76
- Incretins, 244
- Infant, HIV infection in, vertical transmission, 315
- Infection, drug interaction problem, 639–644
- Infection control, 606–622
backflow prevention, 606
biofilm, 618–619
bloodborne pathogen transmission, prevention of, 613–614
clinical implications of, 610–621
considerations for, 619–621
contact dermatitis, 615
dental unit water lines, 618–619
education and training for, 612
educational materials for, 607
environmental, 617–618
exposure prevention and postexposure management of, 612
general recommendations of, 612
hand hygiene for, 614
immunization programs for, 612
latex hypersensitivity, 615
maintenance of records, data management, and confidentiality for, 613
medical conditions, 612–613
organizations and, 607
overview of, 607
patient care items, sterilization and disinfection of, 615–617
personal protective equipment for, 614–615
program, personnel health elements of, 612–621
related links, 607
visual lesson on, 606–607
water quality, 618–619
work restrictions, 612–613
work-related illness, 612–613
- Infectious asthma, 109
- Infectious hepatitis, 152
- Infectious mononucleosis, 220–222
atypical lymphocytes, 221f
clinical presentation of, 221–222
dental considerations for, 222
epidemiology of, 220–221
etiopathogenesis of, 221

- Infectious mononucleosis (*Continued*)
 laboratory and diagnostic findings of, 222
 medical management of, 222
 oral manifestations of, 222
- Infective endocarditis
 absolute risk for, 29
 American Heart Association recommendations, 30–34
 antibiotic prophylaxis for, 27–29
 clinical outcome of, 22
 clinical presentation of, 23–25
 complications of, 19–23
 congenital heart disease and, 4
 considerations for, 32
 definition of, 19
 dental management of, 27–30
 epidemiology of, 19–21
 etiology of, 21
 fever in, 24
 implementation of the recommendations for, 32–33
 laboratory and diagnostic findings in, 25
 lifetime risk of acquiring, 20*t*
 medical management of, 25–27
 pathophysiology of, 21–23
 petechiae in, 24*f*
 predisposing conditions associated with, 21*t*
 signs and symptoms of, 23–25
 special situations for, 32
 treatment for, 26*t*–27*t*
- Inferior vena caval filters (IVCFs), 440–441, 441*f*
- Infiltrative dermatopathy, in Graves disease, 275*f*
- Inflammatory bowel disease, 183–187
 antiinflammatory drugs, use of, 186
 clinical presentation of, 184–185
 complications of, 183–184
 corticosteroids for, 186
 Crohn disease and, 184
 dental management of, 186–187
 epidemiology of, 183
 etiology of, 183
 immunomodulator drugs for, 185
 immunosuppressors for, 186
 incidence of, 183
 laboratory and diagnostic findings of, 185
 medical management of, 185–186
 oral complications and manifestations of, 186–187
 pathophysiology of, 183–184
 prevalence of, 183
 recommendations for, 186
 signs and symptoms of, 184–185
 steroid drug for, 186
 surgery for, 185–186
 ulcerative colitis and, 183–184
- Infliximab, 185
- Influenza
 symptoms of, 608
 vaccination for, 608
- Inhaler, usage, 113*f*
- Inherited bleeding disorders (congenital bleeding disorders), 5, 457
 epidemiology of, 457
 laboratory and diagnostic findings of, 465
- Injection practices, safety, in dentistry, 606
- Insulin
 delivery, 239
 effects of, 256*f*
 levels, graphs of plasma, 240*f*
 noninsulin antidiabetic drugs, 241*t*–242*t*
- Insulin (*Continued*)
 preparations, 238–239
 classified by pharmacodynamic profile, 239*t*
 reaction, signs and symptoms of, 247*b*
 regimens, 239–240
 secretagogues, 243–245
 sensitizers, type 2 diabetes, 243
 therapies, 239
- Insulin shock, 247
 mild stage of, 247
 moderate stage of, 247
 severe stage of, 247
- Interferon-gamma release assay (IGRA), 119
 positive results of, 122
- International normalized ratio (INR), 436
- International Standards for Tuberculosis Care (ISTC), 119–120
- Intestinal mucosa, ulceration of (Crohn disease), 184*f*
- Intestinal transplantation, 372
- Intestinal ulcers, 6
- Intraarterial injection, of drug into arm, 604
- Intraarterial thrombolysis (IAT), 519
- Intracerebral hemorrhage, cause of, 517
- Intraoral lymphoma, 416
- Intravascular catheters, 33–34, 34*t*
- Intravenous sedation, protocol for, 251
- Intrinsic asthma, 109
- Intrinsic pathway
 coagulation cascade indicating, 437*f*
 disorders of, 437
- Ionizing radiation
 and pregnancy, 291
 teratogenicity of, 291–292
- Iron deficiency anemia, 390
 angular cheilitis in, 394*f*
 complications of, 392
 pathophysiology of, 392
 smooth red tongue in, 394*f*
- Ischemic heart disease, 53–69
 bleeding and, 65
 clinical presentation of, 56–58
 complications of, 54–56
 dental management of, 63–67
 considerations for, 65*b*
 epidemiology of, 53
 etiology of, 53–54
 laboratory and diagnostic findings of, 58
 medical considerations for, 63–67
 medical management of, 58–63
 oral manifestations of, 67
 pathophysiology of, 54–56
 risk assessment for, 63–64
 signs of, 58
 symptoms of, 56–58
- Ischemic stroke, hypertension as risk factor for, 516
- Isolated systolic hypertension, 40–41
- Isoniazid, 123*t*
- Ivy bleeding time (BT), 436
- J
- Janeway lesions, 24
- Janus-associated kinase (JAK) inhibitors, for rheumatoid arthritis, 351, 351*t*
- Jarisch-Herxheimer reaction, 217
- Jaundice, 6
 with chronic liver disease, 434*f*
- Jaws
 medication-related osteonecrosis of, 303
 osseous changes of, 205
- Joint surface, cartilage loss, 347*f*
- Juvenile rheumatoid arthritis (JRA), 345
- K
- Kanamycin (Kantrex), 123*t*
- Kaposi sarcoma, 322–323, 328, 499*b*
 erythematous lesions as, 323*f*
 of gingiva, 324*f*
- Kaposi sarcoma-associated herpesvirus (HHV-8), 218
- K-complexes, 138
- Kidney failure, 7
- Kidney transplantation, 370–371
 organ-specific complications of, 375
- Kidneys
 disease, diagnosis of, 198
 important functions of, 193
- Knee, acute hemarthrosis of, 459*f*
- L
- Labial mucosa, aphthous-like ulceration of, 381*f*
- Laboratory screening, for blood transfusion, 5
- Lactate dehydrogenase (LDH), elevated levels of, 410
- Lamotrigine, as mood-stabilizing drugs, 573
- Langerhans cells, 402
- Late pregnancy, supine hypotensive syndrome and, 288
- Late prosthetic joint infection, 353
- Latent syphilis, 215–216
- Latent TB infection (LTBI), 117
- Latex hypersensitivity, 615
- Latex rubber products, 339
 anaphylaxis, manifestation, 339
 hypersensitivity reactions to, 339
- Latex skin tests, 339
- Left atrium, posterior mitral valve leaflet prolapse, 20*f*
- Left ventricular ejection fraction (LVEF) reduction, 86–87
- Left ventricular heart failure (LVHF), 87–88
- Left-sided brain damage, manifestations of, 518*b*
- Left-sided heart failure, effects of, 87*f*
- “Legal highs”, 584–585
- Lepirudin, 442
- Leukemia, 5, 404, 499*b*
 bleeding and, 428
 cause of, 404
 cytogenetic studies, 483–485, 486*f*
 dental management for, 424*b*, 452
 hyperplastic gingiva with, 435*f*
 medical treatment for, 409*t*
 predisposition syndromes, 484*t*–485*t*
 treatment of, drug classes for, 408*t*
- Leukemia cutis, 404–405
- Leukocytosis, 403
- Leukopenia, 358, 403
- Leukoplakia, 135*f*–136*f*, 499–500, 500*t*
 oral hairy, 381–382
- Levonordefrine, drug interactions of, 639–644
- Libman-Sacks verrucous endocarditis, 21–22
- Lichen planus, 557*f*
 oral manifestations of, 285
 thyroid disease and, 285
- Lichenoid drug eruptions, 341
- Lid retraction, from hyperthyroidism, 11*f*
- Lidocaine, drug interactions of, 639–644
- Lifestyle, hypertension and, 39
- Line Probe Assay, 118–119
- Linear gingival erythema, 322–323, 324*f*
- Lingual thyroid nodule, 285*f*

- Lip, vascular malformations of, 181
 Liraglutide, 244–245
 Lispro, 239
 Lithium, as mood-stabilizing drugs, 572
 Liver, 151
 architecture, photomicrographs, 170f
 biguanides, primary site of action in, 243
 Liver disease, 6, 151–175
 dental drugs, metabolism, 168b
 dental management considerations for, 167b
 dental management in, 451–452
 disseminated intravascular coagulation and, 429
 Liver failure, acute, 154
 Liver transplantation, 371
 organ-specific complications of, 375
 Local anesthesia drug toxicity, 600–601
 Local anesthetics
 adverse reactions to, 335b
 allergic reactions to, 335–337
 pregnancy usage, 294
 selection, asthma and, 115
 Long QT syndrome, 74
 Long-acting benzathine penicillin, parenteral injection of, 217
 Long-acting biosynthetic human insulin, 238–239
 Long-term antibiotic therapy, 452
 Low blood pressure, 598
 treatment of, 598
 Low responders, 469
 with major bleeding, 469
 Lower lip, laceration of, 537f
 Low-grade chronic depression, signs of, 575
 Low-grade gastric mucosa-associated lymphoid tissue (MALT) lymphoma, development of, 178
 Low-molecular-weight heparin (LMWH), 441
 Low-risk HPVs, 222
 Lung
 bronchiole occlusion, 109–111, 111f
 changes, gross pathologic specimen, 102f
 tuberculous, gross specimen of, 117f
 Lung cancer, 482t, 496–497, 496f
 diagnosis of, 497
 screening for, 490
 Lung transplantation, 372
 organ-specific complications of, 375
 Lyme disease, 345, 365–366
 complications of, 365–366
 definition of, 365–366
 dental management of, 366
 epidemiology of, 365
 erythema migrans lesion of, 365f
 laboratory and diagnostic findings of, 366
 medical management of, 366
 pathophysiology of, 365–366
 Lymph nodes, 402
 cervical, tuberculosis of, 124f
 enlargement, mandible, 12f
 lymphocytes, location, 402
 regional, anatomy of, 491f
 Lymphadenopathy, 218–219
 Lymphocytes, 402
 localization of, 402
 Lymphoma, 5, 403–404, 412–413
 dental management for, 424b
 features of, 499b
 predisposition syndromes, 484t–485t
 treatment for, 409t
- M
 Macrovascular disease (atherosclerosis), 234
 Maintenance wakefulness test (MWT), 144
 Major depression, 562
 prevalence of, 561
 Malabsorption syndrome, dental management in, 452
 Malignant cells, 485–486
 Malignant melanoma, in chest, 498f
 Malignant neuroleptic syndrome, 575
 Mandibular advancement devices (MADs), 146–147, 146f
 Mandibular tooth abscess, cellulitis from, 251f
 Mania, clinical features of, 565t
 Manic depression, drug interaction problem, 639–644
 Manic episode, features of, 562–564
 Marfan syndrome, 458
 Marginal pool, cells in, 402
 Marijuana, use of, 581, 585–586
 medical considerations for, 589
 Mastocytosis, 176
 Maternal plaque control, 290–291
 Mean arterial pressure, 40
 Median rhomboid glossitis, 181f
 Medical history, 2–9
 blood transfusion, 5
 cardiovascular disease, 2–5
 current physician, 8
 drug, 8–9
 endocrine disease, 7
 functional capacity, 9
 gastrointestinal diseases, 6
 genitourinary tract disease, 7–8
 hematologic disorders, 5
 medicines, 8–9
 musculoskeletal disease, 7
 neurologic disorders, 5–6
 pills, 8–9
 respiratory tract disease, 6–7
 Medication-related oral complications, in organ transplantation, 380
 Medication-related osteonecrosis, of jaw, 303
 Medicines, considerations, 8–9
 Medullary thyroid carcinoma (MTC), 280
 Megaloblastic anemia, 395f
 Melanoma
 of ear, 11f
 features of, 498, 499b
 Memantine (Axura), 529
 Men who have sex with men (MSM), HIV transmission and, 314–315
 Mental disorders, 561
 Meperidine, drug interactions of, 639–644
 Mepivacaine, drug interactions of, 639–644
 MERCI (Mechanical Embolus Removal in Cerebral Ischemia) retrieval system, 519
 Mercurial diuretics, 50
 Metabolic activity, increased, 275
 Metabolic equivalents of tasks (METs), 9
 measurement, 63
 Metallic stent, expandable, 60f
 Metastatic tumors, 268–270
 Metformin, 243
 “Meth mouth”, 593f
 Methamphetamine (“meth”), 583, 587–588
 abuse of, medical considerations for, 590
 Methicillin-resistant *Staphylococcus aureus* transmission, prevention of, 606
 Metronidazole, drug interactions of, 639–644
 Microcytic anemia, 390
 with iron deficiency, 391f
- Middle cerebral artery, aneurysm of, 517f
 Midline neck enlargement
 from goiter, 11f
 from thyroglossal duct cyst, 12f
 Mild (delayed onset) allergic reaction, 602
 Miliary TB, 117
 Mineralocorticoids, 257
 MiniMed Paradigm REAL-Time Revel System, 242f
 Mirtazapine, 572
 Mitral stenosis, 20f
 Mitral valve prolapse, 4
 infective endocarditis and, 19–20
 Mobitz type I (Wenckebach) heart block, 73–74
 Mobitz type II heart block, 73–74
 Monoamine oxidase inhibitors (MAOIs), 572
 adverse effects of, 571t, 578
 drug interactions of, 571t, 578
 Monocytes, 402
 Mood cycles, 564f
 Mood disorders, 561–566
 antidepressants, group of, 566t
 classification of, 545b
 clinical presentation of, 562–564
 definition of, 561
 DSM-IV-TR list in, 563f
 epidemiology of, 561–562, 562t
 etiology of, 561–562
 medical management of, 562–564
 origin, theories in, 561–562
 prevalence of, 561
 recurrent, natural history of, 565f
 treatment, electroconvulsive therapy for, 566
 Mood-stabilizing drugs, 572–575
 “Moon-shaped face”, 260f
 Mouthwash
 for burning mouth syndrome, 634
 for recurrent aphthous stomatitis, 626
 mTOR inhibitor-associated stomatitis, 380–381, 381f
 Mucocoeles, superficial, of soft palate, 384f
 Mucoepidermoid, features of, 499b
 Mucosa-associated lymphoid tissue (MALT) lining, lymphocytes, location, 402
 Mucosal lesions, 623–624
 Mucositis, 422, 506–507, 507f
 Mucous membrane pemphigoid, 632
 Multicomponent insulin, 239
 Multidrug-resistant TB (MDR-TB), 120
 Multilobulated pyogenic granuloma-like lesion, in hematopoietic cell transplant recipient, 381f
 Multinodular goiter, 270f
 Multiple endocrine neoplasia type 2 (MEN2), 280
 Multiple myeloma
 clinical presentation of, 419
 complications of, 419
 definition of, 418
 epidemiology of, 418–419
 etiology of, 418–419
 laboratory and diagnostic findings of, 419
 medical management of, 419–420
 oral complications and manifestations of, 420
 pathophysiology of, 419
 punched-out lytic lesions in, 419f
 signs and symptoms of, 419
 staging and prognostic factors in, 421t
 treatment of, 420t
 Multiple sclerosis, 538–540
 antiinflammatory medications for, 539
 attacks and relapses of, 539

- Multiple sclerosis (*Continued*)
 autoimmune-mediated inflammation and, 538
 axonal damage, complication of, 539
 biologic agents for, 539
 clinical presentation of, 539
 clinical signs of, 539
 complications of, 538–539
 demyelination of, 538
 dental management of, 540
 epidemiology of, 538–539
 general description of, 538
 incidence of, 538
 laboratory and diagnostic findings of, 539
 management of, drugs used in, 540*t*
 medical management of, 539–540
 nervous system, autoimmune disease and, 538
 neurologic disability of, 538
 oral complications and manifestations of, 540
 pathophysiology of, 538–539
 periventricular “demyelinated plaque”, 538*f*
 prevalence of, 538
 Multiple sleep latency test (MSLT), 144
 Muscle rigidity, 523
 Muscle trismus, 511–512
 Musculoskeletal disease, 7
 arthritis, 7
 classification of, 346*t*
 prosthetic joints, 7
Mycobacterium tuberculosis, 116
 primary infection of, 118
 transmission of, 117
 Myelodysplastic syndromes, 404
 Myocardial infarction, 604
 clinical predictors, 64*b*
 dental management considerations for, 66*b*
 medical management of, 61–63, 61*b*
 without ischemic symptoms, dental management considerations for, 65*b*
 Myocardial necrosis, progression of, 57*f*
 Myofascial pain syndrome (MFP), 367
 Myosin heavy chain, altering, 270–271
 Myxedema, 280*f*
- N**
 Nafcillin, for infective endocarditis, 27
 Nails
 examination of, 9–10
 pitting, in psoriatic arthritis, 364*f*
 Naloxone (Narcan), 586, 586*f*–587*f*
 Naltrexone, 589
 Narcotic analgesics, 283
 Nasal mask, usage, 145*f*
 Nasal vasculature pattern, 460
 National Institute for Health and Clinical Excellence (NICE) guidance, antibiotic prophylaxis, 30
 National Marrow Donor Program (NMDP), 373
 Native valve endocarditis (NVE), 19
 Natural medicines, drug potentiation or interference, 648*t*
- Neck
 examination, 11, 14
 lesions, with HIV infection and AIDS, 325*t*
 midline enlargement of
 from goiter, 11*f*
 from thyroglossal duct cyst, 12*f*
 thyroid gland, location of, 268
 Neck dissection, 501
- Necrotizing ulcerative gingivitis, 136*f*
 Needle biopsy, surveillance, 376
 “Neglect” syndrome, 520
Neisseria gonorrhoeae infection, 210–211
 areas of, susceptibility to, 212*f*
 Neonatal hypothyroidism, 279
 Neoplastic syndrome, 280
 Nephron, 194*f*
 Neural changes, 509
 Neurologic disorders, 5–6, 516–543
 behavioral disorders, 6
 convulsions, 6
 epilepsy, 6
 seizures, 6
 stroke, 5–6
 Neuropsychiatric symptoms, in systemic lupus erythematosus, 357
 Neurosyphilis, 216
 Neutral protamine Hagedorn (NPH) insulin, 238–239
 Neutropenia
 cyclic, 403
 oral ulcers caused by, 422*f*
 Neutrophils, 402
 chemotaxis of, 177
 Nicotinamide adenine dinucleotide phosphate (NADPH), 394
 Nicotine, 129–130
 replacement products, 133*t*
 Nicotine replacement therapy, 132–134
 Nicotine stomatitis, severe, in pipe smoker, 136*f*
 Nitrates, for angina, 59, 59*t*
 Nitrous oxide, control of, 297*b*
 Nitrous oxide-oxygen inhalation sedation, 107
 Nodular basal cell carcinoma, 498, 498*f*
 Nonallergic reactions, 334
 Nonbacterial thrombotic endocarditis (NBTE), 21–22, 23*f*
 Noncardiac surgical procedures, cardiac risk stratification for, 64*b*
 Non-Hodgkin lymphoma
 clinical presentation of, 415–416
 complications of, 415
 definition of, 414
 epidemiology of, 414–415
 etiology of, 415
 as gingival enlargement (manifestation), 416*f*
 Hodgkin lymphoma, comparison, 416*t*
 laboratory and diagnostic findings of, 415–416
 medical management of, 416–417
 oral complications and manifestations of, 416–417
 pathophysiology of, 415
 signs and symptoms of, 415
 Noninsulin antidiabetic drugs, 241*t*–242*t*
 Non-nicotine replacement therapy
 pharmacotherapy, 134, 135*t*
 Non-NSAID ulcer disease, *H. pylori*-negative, 177
 Nonpalpable nodules, ultrasound imaging of, 281
 Nonprotein nitrogen compounds, buildup of, 195
 Non-rapid eye movement (NREM) sleep, 138
 electroencephalographic tracings of, 139*f*
 Non-STEMI, 61–62
 Nonsteroidal antiinflammatory drugs (NSAIDs)
 drug interactions of, 639–644
 for rheumatoid arthritis, 349, 351*t*
 use of (etiological factor), 177
- Nontreponemal testing, for syphilis, 216
 Nontricyclic antidepressant agents, 572
 Nonvalvular atrial fibrillation, as risk for stroke, 516
 Nonvalvular cardiovascular devices, 33, 33*t*
 antibiotic prophylaxis for, 206*b*
 Nose, ala of, basal cell carcinomas of, 10*f*
 Nucleic acid amplification, using
 polymerase chain reaction (PCR)-based assays, 318
 Nucleic acid amplification testing (NAAT), 212–213
 Nutritional supplements, 624–625
- O**
 Obesity, obstructive sleep apnea and, 142
 Obesity-hypoventilation syndrome, 138
 Obstructive sleep apnea (OSA), 138–148, 141*f*
 diagnosis of, 143–144
 neurocognitive effects of, 140
 obesity and, 142
 oral appliances for, 146*f*
 prevalence of, 141
 quantification of, 143
 Occupational Safety and Health Association (OSHA), tuberculosis enforcement guidance policy, 124
 Omalizumab (Xolair), 112–113
 Operations, 8
 Opioids, 586
 primary effects of, 586
 withdrawal, 586
 Oral anticoagulant (OAC) therapy, for cardiac arrhythmias, 75
 Oral cancer, 482*t*, 483*f*, 499–501, 499*b*, 500*f*
 Oral candidiasis, 197*f*, 627
 asthma and, 115–116
 buccal mucosa, lesions in, 252*f*
 Oral care patient information sheet, 636*b*
 Oral cavity, primary herpes simplex type 2 of, 221*f*
 Oral condylomata acuminatum, 225–226
 Oral contraceptives, in pregnancy, use of, 295–296
 Oral erythema multiforme, 632–633
 Oral glucose tolerance test (OGGT), 236
 Oral hairy leukoplakia (OHL), 381–382, 381*f*
 Oral infection, cure of, 248–249
 Oral lesions
 herpes simplex with, 624–628
 with HIV infection and AIDS, 325*t*
 painful, symptomatic relief of, 623
 supportive care for, 623–624
 therapeutic management of common, 623–638
 Oral lichen planus, 630–632
 Oral mucosa, pseudomembranous candidiasis of, 322*f*
 Oral mucositis, 379–380
 Oral squamous cell carcinoma
 alcohol abuse and, 593
 biochemical factors in pathogenesis of, 499
 color characteristics of, 500*t*
 spreads by local filtration, 501
 surgery, response, 501
 Oral tissues, tingling sensations of, 576–577
 Oral type I hypersensitivity reactions, 340*b*
 Oral ulceration, associated with ulcerative colitis, 187*f*
 Oral ulcers, caused by neutropenia, 422*f*
 Oral warts, 226

- Organ donation networks, 373
- Organ Procurement and Transplant Network (OPTN), 373
- Organ transplantation, 370–388
- acute rejection in, 373–374
 - adult survival rates after, 371*t*
 - cancer risk of, 375
 - chronic rejection in, 373–374
 - clinical presentation of, 376
 - complications of, 373–375
 - definition of, 370–376
 - dental management for, 377–384
 - risk assessment, 377–378
 - donor-recipient matching for, 373
 - epidemiology of, 370–373
 - essential principles of, 370
 - etiology of, 373
 - graft rejection in, 373–374
 - heart transplantation, 371
 - hematopoietic cell transplantation, 372
 - immunosuppression risk in, 374–375
 - immunosuppressive medications for, 373, 374*t*
 - infection risk in, 374–375
 - intestinal transplantation, 372
 - kidney transplantation, 370–371
 - laboratory and diagnostic findings of, 376
 - liver transplantation, 371
 - lung transplantation, 372
 - medical and surgical management of, 376–377
 - oral complications and manifestations in, 379–384, 380*t*
 - oral infections in, 382–383
 - organ donation networks for, 373
 - organ-specific complications of, 375–376
 - other infrequent infections of, 383
 - pancreas and islet cell transplantation, 371–372
 - pathophysiology of, 373–375
 - pediatric survival rates after, 371*t*
 - posttransplant dental care, 379
 - preparation, dental management for, 378*t*
 - pretransplant dental screening and clearance, 378
 - principles and basic oral care, 377–379
 - recipients, dental management for, 379*t*
 - secondary malignancy in, 383–384
 - signs and symptoms of, 376
 - vascularized composite tissue allotransplantation, 372–373
- Organization for Safety & Asepsis Procedures (OSAP), 607
- Orofacial granulomatosis-like lesions, in organ transplantation, 381, 381*f*
- Orofacial herpes simplex
- clinical description of, 625
 - etiology of, 625
 - intraoral, 625
 - labialis, 625
 - prevention of, 625
 - treatment for, 625
- Oropharynx, gonococcal infection of, 212*f*
- Orthopnea, 90–91
- Osler nodes, 24, 24*f*
- Osler-Weber-Rendu syndrome, 459
- Osteitis fibrosa, 196
- Osteoarthritis (OA), 345, 355–357
- Bouchard nodes in, 356*f*
 - clinical presentation of, 356
 - complications of, 355–356
 - definition of, 355
 - dental management for, 356–357
 - epidemiology of, 355
- Osteoarthritis (OA) (*Continued*)
- etiology of, 355
 - Heberden nodes in, 356*f*
 - laboratory and diagnostic findings of, 356
 - medical management of, 356
 - oral complications and manifestations of, 356–357
 - pathophysiology of, 355–356
 - prosthetic joints, long-term complication, 351–352
 - rheumatoid arthritis, comparison, 347*t*
 - in temporomandibular joint, 357*f*
- Osteogenesis imperfecta, 458
- Osteonecrosis, 302–305
- Osteoporosis, 298–300
- bisphosphonate agents for, 302*t*
 - complications of, 299–300
 - definition of, 298–299
 - drug interaction problem, 639–644
 - epidemiology of, 299
 - laboratory and diagnostic testing for, 300
 - medical management of, 300
 - oral health implications of, 300
 - pathophysiology of, 299–300
 - serum biomarkers for, 300, 300*t*
 - treatment strategies for, 304–305
 - staging and, 304*t*
- Osteoradionecrosis, 512–513, 512*b*, 512*f*
- Osteosclerosis, of variable degree, 196
- Other potentially infectious material (OPIM), preventing exposures to blood and other, 613–614
- Oxacillin sodium, for infective endocarditis, 27
- OxyContin, 583
- P**
- Pacemakers, 82
- electromagnetic interference sources, 78*b*
- Pain
- character, changes in, 179
 - localization, in osteoarthritis, 356
- Pain disorder, 566, 568
- Palatal enamel, destruction of, 183*f*
- Palatal lesion, in AIDS, 324*f*
- Palatal mucosa
- erythematous lesions in, 323*f*
 - ulceration of, 340*f*
- Palatal petechiae, 205*f*
- with leukemia, 436*f*
- Palate
- lesions, 252*f*
 - in AIDS, 322*f*
 - leukoplakia of, 135*f*
- Palpebral fissures, widening, 274
- Palpitations, of heart, 57
- Pancreas and islet cell transplantation, 371–372
- Pancreatic beta cell loss, 232*f*
- Panic attack, 544–547
- drugs used to treat, 549*t*
- Panic disorder
- cause of, 545–546
 - diagnostic criteria for, 547*t*
 - signs and symptoms of, 547*t*
- Pannus, 346
- micrograph of, 347*f*
- Papillary carcinomas, surgery for, 282
- Para-aminobenzoic acid (PABA) esters, 335
- Parabens, allergic reactions to, 330
- Paranoid schizophrenic disorder, 569
- Paraoral type I hypersensitivity reactions, 340*b*
- Parasympathetic system, stimulation of, 546
- Parathyroid glands, 268
- Parathyroid hormone (PTH), secrete, 195–196
- Parkinson disease, 522–527
- carbidopa-levodopa (Sinemet) for, 523–524
 - clinical presentation of, 523
 - complications of, 522–523
 - dental management of, 524–527
 - considerations in, 526*b*
 - drug interaction problem, 639–644
 - drugs used in, management of, 525*t*
 - epidemiology of, 522–523
 - etiology of, 522–523
 - features of, 524*f*
 - general description of, 522
 - genetic and environmental factors of, 522–523
 - incidence of, 522
 - increasing dopamine in, 523
 - laboratory and diagnostic findings of, 523
 - manifestation of, 523
 - medical management of, 523–524
 - oral complications and manifestations of, 526–527
 - oral hygiene in, 526–527
 - pathophysiology of, 522–523
 - substantia nigra, dopaminergic neurons in, 523*f*
 - symptoms progress in, 524
- Parotid glands, painless enlargement of, 591*f*
- alcoholism and, 171*f*
- Paroxysmal nocturnal dyspnea (PND), 90–91
- Partial thromboplastin time (PTT), 436
- Patient
- care items, sterilization and disinfection of, 615–617
 - evaluation, summary, 3*b*
 - risk assessment, summary, 3*b*
- Peak bone mass, 299
- Pediatric drug doses, 605
- Pemphigus, 632
- Penicillin, 337–338
- allergic reaction to, 330
 - skin testing, reliability, 337
 - hypersensitivity, cephalosporins (usage), 338*b*
 - injection, urticarial reaction after, 332*f*
 - reaction, prevention of, procedures for, 338*b*
- Penis, chancre of, 214*f*
- Penumbra stroke system, 519
- Peptic ulcer disease
- clinical presentation of, 179
 - complications of, 177–178
 - dental management of, 180–183
 - considerations in, 182*b*
 - epidemiology of, 176
 - etiology of, 176–177, 177*t*
 - formation, factors of, 178*f*
 - Helicobacter pylori* infection in, antimicrobial regimens for treatment of, 180*b*
 - laboratory and diagnostic findings of, 179
 - medical management of, 179–180
 - medications of, 180
 - oral complications and manifestations of, 181–183
 - pathophysiology of, 177–178
 - recommendations for, 181
 - signs and symptoms of, 179
- Peptic ulcer therapy, 179–180

- Peptic ulceration
incidence of, 176
location of, 177f
prevalence of, 176
- Percutaneous transluminal coronary angioplasty, 60
- Perimylolysis, 183f, 556–557
- Perioperative cardiovascular risk, increase, clinical predictors, 64b
- Peripheral blood smear, of acute lymphoblastic leukemia, 407f
- Peripheral tissues, primary site of action in, 243
- Peritoneal dialysis, 199–200
advantages of, 200
disadvantages of, 200
- Permanent hypothyroidism, 279
- Permanent pacemakers, implantation site of, 77f
- Pernicious anemia, 390, 393f
cause of, 392
long-standing, 392
- Peroxisome proliferator-activated receptor γ (PPAR- γ), 232, 245
- Persistent TB, 117–118
- Personal protective equipment (PPE), 608, 614–615
- Petechiae, 9f
in bleeding, 434
in infective endocarditis, 24f
palatal, with leukemia, 436f
thrombocytopenia, 435f
- Phagocytosis, 195
- Phenylephrine, 572
- Phenylethylamine, 572
- Phenytionin-induced gingival overgrowth, 537f
- Pheochromocytoma, 280
- Philadelphia chromosome, 409–410
- Phobias, 544, 546
- Phosphodiesterase (PD) inhibitors, for chronic obstructive pulmonary disease (COPD) and asthma, 106t–107t
- Physical examination, 9–14
general appearance, 9–11
vital signs, 11–14
- Physician
current, 8
referral and consultation, 15
- Physiologic antithrombotic systems, 434b
- Physiologic leukocytosis, 403
- Phytomedicines, 646
- Pills, considerations, 8–9
- Pilocarpine, 511
- “Pink puffers”, 102
- Pioglitazone, 245
- Pitting edema, with heart failure, 91f
- Plaque, growth and proliferation of, 55
- Plasma
corticosteroid levels, increase, 261
HIV viral load, suppression, 318
- Plasma antithrombin III, 441
- Platelet aggregation inhibitors, for angina, 59t
- Platelet count, 436, 458
- Platelet function analyzer, 436
- Platelets, 430–431
activation, 431b
disorders of, 437–439, 462–466
dysfunction of, 195
functions, 431b
disorders of, 439, 464–466
- Plummer-Vinson syndrome, 398f, 499
- Pneumocystis carinii*, cases of, 309
- Polymerase chain reaction (PCR)-based assays, 318
- Polyproteins, 314
- Polyps, screening for, 487
- Polysomnogram (PSG), 142
5-minute epoch of, 144f
- Positioning, Airway, Breathing, Circulation, Definitive care (P-A-B-C-D) emergency algorithm, 598
- Positive airway pressure (PAP), 145
advantage of, 145
device, patient usage, 145f
- Posterior mitral valve leaflet, prolapse, 20f
- Postexposure prophylaxis (PEP), 322
- Postpartum depression, 290
- Postpartum thyroiditis, 271
- Posttransplant lymphoproliferative disease (PTLD), 375, 384f
- Posttraumatic stress disorder (PTSD), 545
benzodiazepines for, 550
diagnostic criteria for, 547t, 548
eye movement desensitization and reprocessing (EMDR) for, 550
first-line treatment for, 550
incidence of, 548f–549f, 551f
medical management for, 554–556
rate of, 548
second-line treatment for, 550
signs and symptoms of, 547t, 548
- Postural hypotension, 288
tendency of, 288
- Potassium channel blockers, for arrhythmias, 76t
- Pramlintide, 240
- Preclinical Alzheimer disease, 528
- Prediabetes, 231
risk, increase, 237t
- Preeclampsia, 289
sign of, 290
- Preexcitation syndrome, 73
- Pregnancy, 8, 288–298
analgesics for, 294–295
antibiotics for, 295
oral contraceptives and, 295–296
anxiolytics for, 296–297
appetite, increase, 289
blood changes in, 289
cardiovascular changes in, 288
complications in, 288–289
dental caries, relationship between, 298
dental management in, 290–298
considerations of, 290b
dental radiographs in, 291–293
drug administration in, 293–297
endocrine changes in, 288
estrogen and progesterone secretion during, increase, 297–298
fatigue and, 288
Food and Drug Administration labeling for drugs use in, 296f
functional residual capacity (FRC) in, 289
gingivitis, 297–298, 298f
hyperplastic gingival changes in, 297–298
hypertension, signs of, 290
immunologic changes in, 289
ionizing radiation and, 291
teratogenicity of, 291–292
labeling categories of, 293
late, supine hypotensive syndrome in, 288
local anesthetics for, 294
management recommendations for, 290
maternal plaque control of, 290–291
medical history in, 290
medication considerations during, 295t–296t
- Pregnancy (*Continued*)
nitrous oxide control during, 297b
oral complications and manifestations during, 297–298
oral hygiene technique and, 291
pathophysiology in, 288
postpartum period of, 290
prenatal fluoride, benefits of, 291
preventive program in, 290–291
respiratory function, changes in, 289
tooth mobility and, 298
treatment
planning modifications in, 297
timing, 291, 291t
tumor, 297–298, 298f
white blood cell (WBC), changes in, 289
x-ray, exposure of, operator position in, 294f
- Preeclampsia, 153–154, 163–164
- Premature ventricular complexes (PVCs), 74
- Premixed human insulin, 239
- Prescription opioids, use of, 583
- Pressor amines, 283
- Primary adrenal insufficiency (Addison disease), 259–261
risk assessment for, 262
- Primary adrenocortical insufficiency, 258
- Primary gain, 576
- Primary generalized osteoarthritis, 356
- Primary goiter, 268–270
- Primary herpes simplex type 2, 221f
- Primary herpetic gingivostomatitis
clinical description of, 624
etiology of, 624
topical anesthetics and coating agents for, 624
treatment rationale for, 624–625
- Primary hypertension, 39–40
- Primary osteoporosis, 298–299
in postmenopausal women, National Institute for Clinical Excellence (NICE) guidelines for, 302b, 302f
- Primary pulmonary TB, 117–118
- Primary snoring, 138, 140
- Primary syphilis, 214
penis chancre, 214f
tongue chancre, 214f
- Prinzmetal variant angina, 56–57
- Problem list and diagnoses, 15
- Procaine, 335
- Prodromal phase, 163
- Progesterone, secretion of, increased, 297–298
- Progressive bilateral condylar resorption, anterior open bite, 355f
- Progressive periodontitis, panoramic radiograph of, 251f
- Progressive tolerance, amphetamine, 587
- Propoxyphene, drug interactions of, 639–644
- Proptosis, in Graves disease, 273f
- Propylthiouracil, adverse reactions to, 283
- Prostate cancer, 482t, 490, 497–498
screening for, 488t, 497, 497f
- Prosthetic cardiac valves, 23f
- Prosthetic joints, 7
high-risk patients, 354b
long-term complication, 351–352
management of, dental procedures, 354t
- Prosthetic valve endocarditis (PVE), 23f
- Prosthodontics, 512
- Protease inhibitors, 419
introduction of, 310
- Proteases and antiproteases imbalance, 103f

- Protein abnormalities, 272
 Protein C deficiency, 471
 Protein S deficiency, 471
 Prothrombin G20210A mutation, 471
 Prothrombin time (PT), 436, 458
 Proton pump inhibitor (PPI),
 antimicrobials, combination, 179
 Pseudoallergy, 334
 Pseudoephedrine, usage, 588
 Pseudomembranous candidiasis, 322*f*, 507,
 508*f*
 of right buccal mucosa, 382*f*
 Pseudomembranous colitis, 176, 187–189
 clinical presentation of, 188
 Clostridium difficile infection in, 188*f*
 complications of, 188
 dental management recommendations
 for, 188–189
 drug considerations and oral
 manifestations of, 189
 epidemiology of, 187
 etiology of, 187–188
 incidence of, 187
 laboratory and diagnostic findings of,
 188
 medical management of, 188–189
 pathophysiology of, 188
 signs and symptoms of, 188
 Pseudoxanthoma elasticum, 458
 Psoriatic arthritis (PsA), 345, 363–364
 complications of, 363
 definition of, 363
 dental management of, 364
 epidemiology of, 363
 medical management of, 363–364
 nail pitting in, 364*f*
 pathophysiology of, 363
 Psychiatric disorders, 561–580
 classification of, 545*b*
 definition of, 561
 drugs
 adverse effects of, 578
 interactions of, 578
 usage, 569–575
 epidemiology of, 561
 oral complications and manifestations of,
 579
 self-destructive acts in, 579
 treatment planning considerations for,
 578–579
 Psychiatric problems, 561
 Psychogenic shock, 598
 Psychogenic factors, classification of,
 545*b*
 Psychophysiologic disorders, 556
 Psychotic disorders, schizophrenia and,
 570*t*
 Pugh/MELD classification scheme, 172
 Pulmonary disease, 101–127
 Pulmonary edema, resolution of, serial
 chest radiograph demonstration, 90*f*
 Pulmonary emboli, 22–23
 Pulse, 12–13
 carotid, palpation of, 12*f*
 radial, palpation of, 12*f*
 rate, 13
 rhythm, 13
 slow, 598
 treatment of, 598
 Pulse oximeter, 113–114
 Pulse pressure, 40
 Pulsus alternans, 91
 Purified protein derivative testing, 119
 significance of positive results, 119*t*
 Purpura (petechiae), 460*f*
 P wave, 70
 Pyogenic granuloma, 298*f*, 380, 381*f*
 Pyostomatitis vegetans, 187, 187*f*
 Pyrazinamide (generic), 123*t*
 Q
 QuantiFERON-TB Gold-in-Tube test, 119
 R
 Radial pulse, palpation of, 12*f*
 Radiation caries, 511, 511*f*
 Radiation therapy, 8
 complication of, management of,
 504–509, 504*b*, 506*b*
 bleeding, 509
 carotid atheroma, 513
 fungal infection, 511
 mucositis, 506–507, 507*f*
 muscle trismus, 511–512
 neural and chemosensory changes, 509
 osteoradionecrosis, 512–513, 512*b*,
 512*f*
 prosthodontics, 512
 secondary infections, 507–509
 tooth sensitivity, 511
 Radioactive iodine (RAI), 272
 Radioactive iodine uptake (RAIU),
 measurement of, 272
 Radiofrequency catheter ablation, 77–78
 Radiographic examinations, effective dose
 from, 292*t*
 Raloxifene, sites of action of, 301*f*
 Randomized controlled trial (RCT), 646
 Rapid plasma reagin (RPR) test, 216
 Rapid-acting insulin, 239–240
 Recombinant tissue-type plasminogen
 activator (rt-PA), augmentation of, 519
 Rectal cancer, screening for, 487
 Recurrent herpes simplex virus, 509*f*
 eruptions, development, 509
 Recurrent herpes simplex virus infection,
 219*f*
 Recurrent mood disorders, natural history
 of, 565*f*
 Red blood cells
 disorders, 390–401
 medical considerations for, 396
 mass, enlargement of, 275–276
 Red tongue, smooth, 394*f*
 Reed-Sternberg cells, 413
 large, 414*f*
 Reentry arrhythmias, 71
 Regional lymph node anatomy, 491*f*
 Reinfarctions, risk of, 3–4
 REM sleep, 138–140
 phasic events in, 140*f*
 Removable partial denture framework,
 allergic reaction to, 341*f*
 Renal dialysis, 176
 dental management in, 452
 Renal dysfunction, infective endocarditis
 with, 22–23
 Renal failure, assessment of, laboratory
 values for, 199*t*
 Renal function
 assessment of, laboratory values for, 199*t*
 loss of, 193
 serum enzyme, relationship, 198*f*
 Renal function tests, 58
 Renal osteodystrophy, 195–196
 changes of, result in, 196*f*
 Renal transplant, 207
 Replacement products
 infection with, risk of, 470
 nicotine, 133*t*
 Replacement therapies, Food and Drug
 Administration-approved, 462*t*
 Repolarization, disorders of, 74
 Respiration, 14
 Respiratory arrest, 603
 Respiratory difficulty, 601–604
 Respiratory disturbance index (RDI), 143
 Respiratory function, changes in, 289
 Respiratory tract disease, 6–7
 allergies, 6
 asthma, 6
 chronic bronchitis, 6
 emphysema, 6
 hives, 6
 sleep apnea, 7
 snoring, 7
 tuberculosis, 6–7
 Retinopathy, 233–234
 Revascularization, 60
 Reverse transcription, as HIV-1 infection
 stages, 314
 Reversible ischemic neurologic deficit
 (RIND), 518
 Rheumatic fever, 4
 Rheumatic heart disease (RHD), infective
 endocarditis and, 19–20
 Rheumatism, 345
 Rheumatoid arthritis (RA), 345–355
 antibiotic prophylaxis regimens for,
 354*b*
 clinical presentation of, 347–348
 complications of, 346–347
 definition of, 346
 dental management of, 352–355
 considerations for, 352*b*
 diagnosis of, criteria for, 348*b*
 drugs for management of, 351*t*
 epidemiology of, 346
 etiology of, 346
 extraarticular manifestations of, 348
 hands, 348*f*
 laboratory and diagnostic findings of,
 348
 management of, drugs for, 349
 medical management of, 348–352
 oral complications and manifestations in,
 354–355
 osteoarthritis, comparison, 347*t*
 pathophysiology of, 346–347
 as pleomorphic disease, 347
 prosthetic joints, long-term complication,
 351–352
 treatment planning modification for, 354
 Rheumatoid factor, 346
 Rheumatologic disorders, 345–369
 categories of, 345
 complications of, 345–346
 definition of, 345
 management of, drugs for, 350*t*
 pathophysiology of, 345–346
 Ribonucleic acid (RNA), reverse
 transcription of, 314
 Riedel thyroiditis, 268–270
 Rifampin, 123*t*
 Right knee, hemarthrosis of, 467*f*
 Right ventricular failure, 90–91
 Right-sided brain damage, manifestations
 of, 518*b*
 Right-sided heart failure
 cause of, 88
 effects of, 87*f*
 Risk assessment, 15–16
 age and, 16
 based patient and treatment factors, 16*t*
 Rivaroxaban (Xarelto), for cardiac
 arrhythmias, 80–82
 Rosiglitazone, 245
 Roth spots, 24, 25*f*

- S**
- Saccharomyces cerevisiae*, 157
- Saliva stimulants, 630
- Saliva substitutes, 630
- Salivary gland dysfunction
management of, 362*t*
in Sjögren syndrome, 360–361
- Sanctuaries, 408
- Sarcoplasmic reticulum adenosine triphosphatase (ATPase), alteration of, 270–271
- Schilling test, 394
- Schizophrenia, 568–579
characteristics of, 570*t*
classification of, 545*b*
clinical presentation of, 569
dental management of, 575–579
considerations in, 576*b*
drug interaction problem, 639–644
drug treatment for, 569–570
emotional change in, 569
epidemiology of, 569
medical considerations for, 575–578
medical management of, 569
neurophysiologic defect, biologic hypothesis for, 569
prevalence of, 568–569
psychotic symptoms of, 569
thought disturbance, types of, 569
triggered by, 569
- Schizophrenic disorders, types of, 569
- Scleroderma (SD), 345
- Scott syndrome, 464–465
- Screening, Brief Intervention, Referral, and Treatment (SBIRT), Center for Substance Abuse Treatment (CSAT) initiative, 590–591
- Scrofula, 123
- Secondary adrenocortical insufficiency, 258, 261
cause of, 259–260
risk assessment for, 262
- Secondary gains, 576
- Secondary hyperparathyroidism, 195–196
- Secondary infections, 507–509
- Secondary osteoporosis, 298–299
in postmenopausal women, National Institute for Clinical Excellence (NICE) guidelines for, 302*b*, 302*f*
- Secondary syphilis, 214–215
lesions of, 215*f*
- Secondary TB, 117–118
- Second-generation antidepressant drugs, 572
- Second-generation (atypical) antipsychotic drugs, 573
- Sedative-hypnotics, 588
- Sedatives, 283
drug interactions of, 639–644
- Seizure disorder, drug interaction problem, 639–644
- Seizures, 6, 600
- Selective serotonin reuptake inhibitors (SSRIs), 572
adverse effects of, 571*t*
drug interactions of, 571*t*, 639–644
- Serotonin-norepinephrine reuptake inhibitors (SNRIs)
adverse effects of, 571*t*
drug interactions of, 571*t*
- Serum cobalamin assay, 394
- Serum creatinine, monitoring of, 376
- Serum enzyme, renal function to, relationship of, 198*f*
- Serum hepatitis, 152
- Serum lipid levels, elevation in, 53
- Serum sickness-like syndrome, 154
- Severe angina, 4
- Severe hypothyroidism, 281*f*
- Severe (immediate onset) allergic reaction, 602–603
- Sexual history, taking, 211*b*
- Sexual impotence, 235
- Sexually transmitted diseases (STDs), 7–8, 210–228
classification of, 211*b*
complications of, 210
definition of, 210
as health problem, 210
implications of, 210
- Shingles, 625–626
- Short-acting β_2 -adrenergic agonists, 113, 115
- Sialometry, 361
- Sickle cell anemia, 390, 392*f*–393*f*, 399*f*
complications of, 392
dental management considerations in patient with, 397*b*
pathophysiology of, 392
- Sickle cell disease, 5
- Simple goiter, 268–270
- Simple phobias, 546
- Simvastatin (Lipitor), 67
- Single alcohol screening question (SASQ), 591
- Sinoatrial (SA) node, 70
- Sinus arrhythmia, 72–73
- Sinus bradycardia, 73
- Sinus nodal disturbances, 72–73
- Sinus tachycardia, 72–73
- Sinuses of Valsalva, calcium (nodular masses), 20*f*
- 6-minute walk distance test, 102–103, 111
- Sjögren syndrome (SS), 7, 345, 359–363
clinical manifestations of, 361*t*
clinical presentation of, 360–361
complications of, 360
definition of, 359–360
dental management of, 361–363
diagnostic criteria for, 361*b*
dry and fissured tongue in, 363*f*
epidemiology of, 360
etiology of, 360
hypergammaglobulinemia in, 361
hyposalivation in, 360–361
laboratory and diagnostic findings of, 361
moisture and lubrication for, 361–362
oral complications and manifestations of, 362–363
pathophysiology of, 360
prevention and maintenance of, 363
salivary gland dysfunction in, 360–361
- Skin
examination of, 9–10
rashes, diabetes, associated with, 235
spider angioma, 435*f*
- Skin cancer, 482*t*, 498–499
- Skin popping, cocaine, 587
- Sleep
histogram, 141*f*
lack of, on postpartum period, 290
phases of, 138
restorative benefits, gaining, 140
stages of, 139*t*
progression, histogram, 140*f*
- Sleep apnea, 7
- Sleep spindles, 138
- Sleep-related breathing disorders, 138–149
behavioral modification for, 145
clinical presentation of, 142
- Sleep-related breathing disorders
(Continued)
clinical spectrum of, 139*f*
definition of, 138–140
epidemiology of, 140–141
etiology of, 141–142
laboratory and diagnostic findings of, 142–144
medical management of, 144–148
oral appliances for, 145–147
pathophysiology of, 141–142
positive airway pressure, 145
signs and symptoms of, 142
surgical approaches, 147–148
- Slow calcium channel blockers, for arrhythmias, 76*t*
- Slow pulse, 598
treatment of, 598
- Smokeless tobacco, 128
use, 130*f*
- Smoking, 128–137
see also Tobacco smoking
annual costs of, 129*t*
complications of, 128–131
dental management for, 131–134
economic impact, 128
epidemiology for, 128, 129*f*
medical management for, 131
oral manifestations and complications of, 134–135
pathophysiology of, 128–131
quitting, 130–131
benefits of, 131*b*
- Smoking cessation
counseling, 132
interventions for, 131
patient education literature, 132
support material, resources for, 132*b*
- Snoring, 7, 138–148
occurrence, 140–141
primary, 138, 140
- Snuff dipper's pouch, 136*f*
- Snuff user, verrucous carcinoma in, 136*f*
- Social phobias, 546
- Socket sclerosis, 205
- Sodium-glucose co-transporter 2 inhibitors, 245–246
- Soft palate
mucosa, ecchymoses, 435*f*
superficial mucocoeles of, 384*f*
- Soft tissue, numbness of, 576–577
- Solar cheilosis, 629
- Solid organs, hyperacute rejection of, 373–374
- Somatization disorder, 567
- Somatiform disorders, 566–568
characteristics of, 576–577
classification of, 545*b*
clinical presentation of, 567–568
conversion disorder as, 567–568
conversion reaction in, 567
definition of, 566
epidemiology of, 566–567
establishing, diagnosis of, 577
etiology of, 567
factitious disorder as, 568
features of, 568*t*
hypochondriasis as, 568
medical considerations of, 576–577
medical management of, 567–568
oral symptoms of, 576–577
pain disorder as, 568
physical complaints for, 566
prevalence of, 566–567
somatization disorder as, 567
treatment of, 568

- Sphygmomanometer, 40, 41f
- Spider angioma, 171, 171f
as sign of alcoholism, 591f
skin, with chronic liver disease, 435f
- Spirometry
for asthma, 111
for COPD, 102–103
discussion, 104f
for pulmonary function, 376
- Spleen, lymphocytes, location, 402
- Splenomegaly, 24
- Splinter hemorrhages, in infective endocarditis, 24, 24f
- Split products, 433
- Split-night study, 142
- Spontaneous abortion (miscarriage), 289–290
- Spontaneous bleeding, 446
- Squamous cell, features of, 499b
- Squamous cell carcinoma, 491f, 500–501, 500f
- oral
alcohol abuse and, 593
biochemical factors in pathogenesis of, 499
color characteristics of, 500t
spreads by local filtration, 501
surgery, response, 501
of right buccal mucosa
after hematopoietic cell transplantation, 384f
of tongue, 135f
- St. John's wort, drug interactions of, 648
- Stable angina, 56–57, 58b
without ischemic symptoms, dental management considerations for, 65b
- Stable angina pectoris, medical management of, 58b
- Standard deviations (SDs), 298–299
- Staphylococci, 21
- Starr-Edwards caged ball mechanical valve, 23f
- Statins, 60
- Status asthmaticus, 111
- Status epilepticus, 533
- Steady-state viremia, development of, 315
- Stent, 5
- Sterilization, of patient care items, 615–617
- Steroids, 8
supplementation, recommendations for, 261t
system, for recurrent aphthous stomatitis, 627
topical, for recurrent aphthous stomatitis, 626
- Stethoscope, 13, 41f
placement, 13f
- Stevens-Johnson syndrome, 573, 633
- Stomach ulcers, 6
- Stomatitis, 340f
- Streptococcus mutans*, 21
- Streptococcus oralis*, 21
- Streptococcus pneumoniae*, vaccination against, 395–396
- Streptococcus salivarius*, 21
- Streptococcus sanguis*, 21
- Streptomycin (generic), 123t
- Stress
management of, for hypertension, 47–48
reduction, 17
protocol, 3b
- Stress-related disorders, medical management for, 556
- Stroke (cerebrovascular accident), 5–6, 516–522, 600
bleeding, risk for, 520
blood pressure
lowering, 519
monitoring, 520
causes of, 517
cerebrovascular disease and, 517
clinical manifestations of, 518
clinical presentation of, 518
communication techniques for, 522b
completed stroke, 518
complications of, 517–518
death, outcome of, 517–518
definition of, 516
dental management of, 519–522
considerations in, 521b
epidemiology of, 516–518
hypertension, as risk factor for, 516
incidence of, 516
laboratory and diagnostic findings of, 518
lesion, brain demonstrating, computed tomography scan of, 519f
medical management of, 518–519
MERCİ (Mechanical Embolus Removal in Cerebral Ischemia) retrieval system for, 519
oral manifestations and complications of, 521–522
pathophysiology of, 517–518
prevalence of, 516
prevention of, 519–520
preventive therapies for, 519
residual deficit in, 518
risk factors for, 520b
risk of
assessment of, 520
epidemiologic studies and, 516–517
as significant health problems, 516
signs and symptoms of, 518
stroke-in-evolution, 518
treatment for, 519
- Stroke volume, preload, contractility, afterload interactions, 88f
- Stroke-in-evolution, 518
- Strontium ranelate (Sr2), sites of action of, 301f
- ST-segment elevation myocardial infarction (STEMI), 61–62
- Subacute painful thyroiditis, 268–270
medical consultation, percentage of, 271
- Subclinical hypothyroidism
diagnosis of, 271
prevalent condition of, 278–279
- Subcutaneous ecchymoses, trauma, 459f
- Subcutaneous fluid, accumulation of, 279
- Subendothelial tissues, 431
- Submandibular region, swelling (intraoral trauma), 467f
- Substance abuse, 8, 581, 585
disorders, classification of, 545b
- Substance dependence, 584–585
- Substantia nigra, dopaminergic neurons, pigmentation of, 523f
- Substernal pain, 4
- Subtotal thyroidectomy, complications of, 282
- Sudden cardiac death, numbers, 57
- Suicidal patients, medical consideration for, 577–578
- Suicide
firearms, use of, 578f
occurrence of, 566
- Sulfasalazine, 185
- Sulfites, allergic reactions to, 330
- Sulfonylureas, 243
- Superinfection, 160
- Supine hypotensive syndrome, 288
- Supine position, dental chair in, 537f
- Supraventricular arrhythmias, 72–74
- Supraventricular cardiac dysrhythmias, 275
- Surgery, for cardiac arrhythmias, 78
- Swallowing, foreign object, 601
- Sympathetic nervous system, overactivation of, 546
- Syncope, 598
tendency of, 288
- Synovitis, pannus (micrograph), 347f
- Synovium, 345
edema of, 346
- Synthetic glucocorticoids (cortisol-like drugs), 256–257
- Syphilis, 213–218
clinical presentation of, 214–216
congenital, 216, 217f
dental considerations for, 217
epidemiology of, 213
etiopathogenesis of, 213–214
incidence of, 213
latent, 215–216
long-acting benzathine penicillin for, parenteral injection, 217
medical management of, 217
nontreponemal testing for, 216
oral manifestations of, 217–218
prevalence of, 213
primary, 214, 214f
secondary, 214–215, 215f
serologic tests for, 216
tertiary, 216
treponemal testing for, 216–217
- Systemic lupus erythematosus (SLE), 345, 357–359
buccal mucosa ulceration in, 359f
butterfly-shaped rash, 358f
clinical presentation of, 357–358
complications of, 357–358
definition of, 357
dental management of, 358–359, 359b
epidemiology of, 357
etiology of, 357
laboratory and diagnostic findings of, 358
medical management of, 358
oral complications and manifestations of, 359
pathophysiology of, 357–358
pulmonary manifestations of, 357–358
treatment planning considerations for, 359
- Systolic pressure, 40
- T
- Tachycardia, 13
atrioventricular junction, involvement, 73
as HF indicator, 91
- Tardive dyskinesia, as late extrapyramidal adverse effect, 574
- Taste disorders, 635
- Teeth (tooth)
changes in, 205
extraction, bleeding problems after, 445–446
fracture of, 537f
sensitivity, 511
- Telangiectasias, 459
- Temperature, 14
- Temporal arteritis, 345
- Temporomandibular joint (TMJ), osteoarthritis of, 356–357, 357f
- Teriparatide, sites of action of, 301f

- Tertiary adrenal insufficiency, 261–262
cause of, 259–260
- Tertiary neuroborreliosis, 366
- Tertiary syphilis, 216
- Tetracyclics
adverse effects of, 571*t*
drug interactions of, 571*t*
- Tetracyclines, 639–644
- Tetralogy of Fallot, 19–20, 22*f*
- Thalidomide, 419
- Theophylline, 104–105
- Thiazolidinediones, 245
- Thought content, disorder of, 569
- Thought disturbance, type of, 569
- Thrombin, 431
- Thrombin time (TT), 436–437, 458
- Thrombocytopenia
bleeding caused by, 359
dental management in, 452
leukemia and, 428
petechiae, 435*f*
- Thrombocytopenia purpura, 460*f*
- Thromboplastin, 431–432
- Thrombosis, 440–441
- Thrombotic disorders, classification of, 429*b*, 458*b*
- Thromboxane, 431
- Thrombus, colored scanning electron micrograph, 432*f*
- Thyroglobulin antibodies (TgAb), 272
- Thyroglossal duct cyst, 268*f*, 270*f*
midline neck enlargement caused by, 12*f*
- Thyroid acropachy, autoimmune thyroid disease, manifestation of, 275*f*
- Thyroid cancer, 280–285
classification of, 280*t*
dental management of, 282–285
etiology and clinical findings of, 280–281
laboratory and diagnostic findings of, 281
medical management of, 282
oral manifestations of, 285
physical examination of, 281
prognosis of, 282
treatment of, 282
ultrasound imaging for, 281
- Thyroid conditions, causes of, 269*t*
- Thyroid disease, 7, 268–287
complications of, 268
concerns in, 268
definition of, 268
dental management considerations for, 284*b*
epidemiology of, 271
etiology of, 271–272
laboratory and diagnostic findings of, 272, 272*t*
medical problems associated with, 283*b*
oral manifestations of, 285
- Thyroid disorders, clinical findings and treatment of, 274*t*
- Thyroid function tests, 58
- Thyroid gland, 268–277
diffuse enlargement, Graves disease, 270*f*
enlargement of, 268–270
hyperplasia (goiter), 282
examination of, 282
function of, 270–272
inflammation of, 277
location of, 268
nodules of, 268–270
radioactive iodine uptake (RAIU) of, 272
toxic adenoma of, 270*f*
- Thyroid hormone, 270
direct and indirect effects of, 273
- Thyroid lesions, ultrasonography of, 272
- Thyroid malignancy, manifestations of, 281
- Thyroid nodules, 271
diagnosis of, 281
fine-needle aspiration of, 281*f*
lingual thyroid nodule, 285*f*
- Thyroid peroxidase antibodies (TPoAb), 272
- Thyroid-binding albumin (TBA), binding plasma protein of, 272
- Thyroiditis, 277–278
oral manifestations of, 285
types of, 278*t*
- Thyroid-stimulating hormone (TSH), 271–272
stimulation test, 272
- Thyroinvasive secondary goiters, 268–270
- Thyrostimulatory secondary goiters, 268–270
- Thyrotoxic crisis
development of, 282–283
management of, 277
- Thyrotoxicosis factitia, 277
- Thyrotoxicosis (hyperthyroidism), 273–277
adrenergic component in, management of, 277
antithyroid agents for, 276
antithyroid drugs, side effects of, 276*b*
causes of, 277
chronic infection of, 282
clinical presentation of, 273–276
emotional lability of, 275
laboratory findings of, 276
medical considerations of, 282–283
medical management of, 276–277
signs and symptoms of, 273–276
treatment of, 276, 276*b*
- Thyrotropin-releasing hormone (TRH), 271–272
- Thyroxine (T₄), secretion of, 270
- Thyroxine-binding globulin (TBG), binding plasma protein, 272
- Ticlopidine, 60
- Tissue factor pathway inhibitor (TFPI), 430
- Tissue thromboplastin, 430
- T lymphocytes, 333, 402
- Tobacco pouch, 136*f*
- Tobacco smoking
see also Smoking
as cause of COPD, 101
lung cancer and, 496
- Tobacco use
oral squamous cell carcinoma and, 593
risk factor, 8
- Tofacitinib (Xeljanz), 351
- Tolerance, definition of, 581
- Tongue
brown hairy, 136*f*
chancre of, 214*f*
dry and fissured, in Sjögren syndrome, 363*f*
eczymosis of, 405*f*
lesion, in hairy leukoplakia, 324*f*
papillary atrophy of, 557*f*
smooth red, 394*f*
squamous cell carcinoma of, 135*f*
- Tongue-retaining devices (TRDs), 146–147, 146*f*
- Tooth. *see* Teeth
- Toothpaste, allergic reaction (stomatitis), 340*f*
- Topical anesthetic, for oral lesions, 623
- Topical hemostatic agents, 474*t*
- Total thyroidectomy, complications of, 282
- Toxic epidermal necrolysis, 573
- Toxic megacolon, 183–184
- Toxic reactions (overdose), opiates, 586
- Tranexamic acid, 449, 475
- Transient ischemic attack (TIA), 518
- Transthyretin, binding plasma protein of, 272
- Trauma, bleeding problems after, 446
- Treatment modifications, 16–17
- Treponema pallidum*, 213–214
invasion of, 213–214
- Treponemal testing, for syphilis, 216–217
- “Triad asthmaticus”, 109
- Triamcinolone acetonide, 626
- Tricyclic antidepressants, 570–572
adverse effects of, 578
drug interactions of, 578
- Triiodothyronine (T₃), 270
- Troponin assays, 58
- Troponins, 58
- Tryptase blood tests, 334
- TSH receptor antibodies (TSHRAb), 272
- T-SPOT TB test, 119
- Tuberculin skin test (TST), 119, 612
positive results, 122
- Tuberculosis (TB), 6–7, 116–124
administrative controls for, 609
baseline screening for, 609
of cervical lymph nodes, 124*f*
chemotherapy, effectiveness, 119–120
clinical implications of, 609
clinical presentation of, 118
clinically active sputum-positive, 121–122
complications of, 117–118
in dental care settings, prevention of, CDC guidelines, 609–610
dental management of, 120–123
considerations for, 123*t*
environmental controls for, 609
epidemiology of, 116
etiology of, 116–117
high risk groups, 116*b*
history, 122
dental management, 121*b*
infection
control recommendations, 607
progression (risk), 118*b*
laboratory and diagnostic findings of, 118–119
medical management of, 119–120
noninfectious during therapy, 122*b*
Occupational Safety and Health Association enforcement guidance policy, 124
oral complications and manifestations of, 123
outpatient dental setting, Centers for Disease Control and Prevention (CDC) guidelines, 121*b*
pathophysiology of, 117–118
precautions for outpatient dental settings, 609–610
respiratory protection controls for, 609–610
risk categories and recommended testing frequency, 609
signs and symptoms of, 118
treatment of, drug regimens for, 120*b*
- Tumoricidal efficacy, 492
- Tumors, 8
- T wave, 70
- 2009 H1N1 influenza
control of, 608–609
transmission, prevention, 607
- Type 1 diabetes
clinical evolution of, 232*f*
clinical features of, 235*t*

- Type 1 diabetes (*Continued*)
 complication of, 251
 medical management of, 238*b*
 result of, 231
 symptoms of, 235
 treatment of, 239
- Type 2 diabetes
 characterization of, 231
 clinical features of, 235*t*
 combination therapy for, 246
 complication of, 251
 components of, 232
 emerging therapies for, 246–247
 injectable formulations for, 244–245
 insulin sensitizers for, 243
 liver, primary site of action in, 243
 management of, 242, 246*f*
 medical management of, 238*b*
 occurrence of, 235
 oral agents for, 243
 peripheral tissue in, 243
 treatment of, 240
- Type I hypersensitivity, 331–333
 oral complications and manifestations of, 339
 reactions
 to dental materials and products, 338–339
 oral or paraoral, 340*b*
 severe, management of, 342–343
- Type II hypersensitivity, 333
- Type III hypersensitivity, 333
 oral complications and manifestations of, 339–340
 reaction, to dental materials and products, 338–339
- Type IV hypersensitivity, 333–334
 oral complications and manifestations of, 340–341
 reaction, to dental materials and products, 338–339
- U**
- Ulcerative colitis, 183–184
 oral ulceration associated with, 187*f*
 progression of, 183–184
 signs and symptoms of, 184
- Ulcerative periodontitis, necrotizing, 324*f*
- Uncomplicated gonococcal infection, treatment of, 213
- Unconsciousness, treatment for, 598–601
- Uncontrolled hypertension, severe, 42–44
 management of, 45*t*
- Undifferentiated schizophrenic disorder, 569
- Unilateral facial paralysis in Bell palsy, 10*f*
- United Network for Organ Sharing, 373
- Unknown cause, response to, 605
- Unstable angina, 56–57
 dental management considerations for, 66*b*
- Upper airway resistance syndrome (UARS), 138
- Upper airway surgery
 invasiveness, 147
 procedure, 147
- Urea breath tests (UBTs), 179
- Uremia, 193, 437, 439
 develop, 195
- Uremic frost, 197–198, 205
- Uremic stomatitis, 205
- Urine, glucose excretion, hyperglycemia leads to, 232
- Urticaria, 332
- Urticarial reaction, penicillin injection after, 332*f*
- V**
- Vaccination, 608
- Vagus nerve stimulation (VNS), 535
- Valacyclovir (Valtrex), 625
- Valproic acid, as mood-stabilizing drugs, 572–573
- Varenicline (Chantix), 134, 135*t*
- Varicella zoster
 clinical description of, 625
 etiology of, 625
 treatment for, 625–626
- Varicella-zoster virus, 218
- Vascular access infection, 201
- Vascular cancer predisposition syndromes, 484*t*–485*t*
- Vascular defects, 439, 459–460
 clinical findings for, 459–460
 laboratory and diagnostic findings for, 460
- Vascular endothelial cells, 430
- Vascular wall alteration, dental management in, 452
- Vascularized composite tissue allotransplantation, 372–373
- Vasoconstrictors, 48–49, 66–67
 for cardiac arrhythmias, 82
 drug interactions of, 639–644
- Venerae Disease Research Laboratory (VDRL) slide test, 216
- Venous access, catheters for, 34*t*
- Venous thrombi, 440
- Venous thromboembolism, 470
- Ventricular arrhythmias, 74
- Ventricular failure, 88–89
- Ventricular fibrillation, 57, 74
- Ventricular flutter, 74
- Ventricular septal defect, 21*f*
- Ventricular tachycardia (VT), 74
- Verrucous carcinoma, in snuff user, 136*f*
- Vessel wall, 430
- Viral capsid antigen (VCA-IgM and VCA-IgG), antibody tests to, 222
- Viral DNA, export of, 314
- Viral hepatitis, 151
- Viral RNA, polymerase chain reaction (PCR)-based assays of, 318
- Viremia, 218–219
- Viridans* streptococci, 23*f*, 375
- Viridans* streptococci (α -hemolytic streptococci), 21
- Virions
 assembly of, 314
 budding of, 314
- Vital signs, 11–14
- Vitamin E, 430
- Vitamin K, 430
- von Willebrand disease, 437, 457–458, 462–464
 clinical presentations of, 464, 465*f*
 dental management considerations for, 476*b*
- von Willebrand disease (*Continued*)
 laboratory and diagnostic findings of, 464
 medical management of, 464
 multimeric patterns of, 464*t*
 signs and symptoms of, 464
 surgical procedures for, 475
- von Willebrand factor
 deficiency of, 457
 gene and protein, structure of, 463*f*
- W**
- Waldeyer ring, 416
- Warfarin (Coumadin)
 bleeding and, 428
 for cardiac arrhythmias, 80
 dental management in patients taking with, 450*b*
 therapy, recommended therapeutic range for, 443*t*
- Water quality, infection control, 618–619
- Weight, 14
- White blood cells (WBCs)
 changes in, pregnancy, 289
 decrease, 275–276
 disorders of, 402–427
 adverse drug effects and, 424
 definition of, 402–403
 dental management for, 420–425
 growth and development and, 424
 management of patients in remission with, 424–425
 medical complications in, 422–423
 medical considerations for, 420–421
 neutropenia and infection in, 422–423
 pretreatment evaluation and considerations for, 421–422
 treatment planning modifications for, 421–425
 dyscrasias, classification and features of, 403*b*
- White coat hypertension, 40
- Wiskott-Aldrich syndrome, 464–465
- Withdrawal
 definition of, 581, 585
 opioids, 586
- Women
 gonorrhea infection in, 212
 health issues, 288–307
 definition of, 288
 hemophilia A in, manifestation, 466
- Wrist, skin of, lichen planus on, 557*f*
- X**
- Xanthomas, of eyelids, 11*f*
- Xerostomia, 593, 629–630
- X-ray, exposure of, operator position in, 294*f*
- Y**
- Yoga, definition of, 645
- Z**
- Zollinger-Ellison syndrome, 176
- Zona fasciculata, 255
- Zona glomerulosa, 255
- Zona reticularis, 255
- Zymogen, 431

This page intentionally left blank

This page intentionally left blank

This page intentionally left blank